



Website:<http://biz.LGservice.com>
E-mail:<http://www.LGService.com/techsup.html>

COLOR MONITOR

SERVICE MANUAL

CHASSIS NO. : CA-113

FACTORY MODEL: FB770G

MODEL: FLATRON F700B (FB770G-EA)

FLATRON 775FT Plus (FB770G-EA)

*() ID LABEL Model No.

CAUTION

BEFORE SERVICING THE UNIT,
READ THE **SAFETY PRECAUTIONS** IN THIS MANUAL.



CONTENTS

SPECIFICATIONS	2	ADJUSTMENT	11
SAFETY PRECAUTIONS	3	TROUBLESHOOTING GUIDE	13
TIMING CHART	4	EXPLODED VIEW.....	23
OPERATING INSTRUCTIONS	5	REPLACEMENT PARTS LIST	25
WIRING DIAGRAM	6	PIN CONFIGURATION.....	30
DISASSEMBLY	7	SCHEMATIC DIAGRAM.....	31
BLOCK DIAGRAM	8	PRINTED CIRCUIT BOARD.....	33
DESCRIPTION OF BLOCK DIAGRAM.....	9		

SPECIFICATIONS

1. PICTURE TUBE

- Size : 17 inch
- Deflection Angle : 90°
- Neck Diameter : 29.1 mm
- Stripe Pitch : 0.24 mm
- Face Treatment : W-ARASC (Anti-Reflection and Anti-Static Coating)
- Internal : Anti-Glare

2. SIGNAL

- 2-1. Horizontal & Vertical Sync
 - 1) Input Voltage Level: Low=0~1.2V, High=2.5~5.5V
 - 2) Sync Polarity : Positive or Negative
- 2-2. Video Input Signal
 - 1) Voltage Level : 0 ~ 0.7 Vp-p
 - a) Color 0, 0 : 0 Vp-p
 - b) Color 7, 0 : 0.467 Vp-p
 - c) Color 15, 0 : 0.7 Vp-p
 - 2) Input Impedance : 75 Ω
 - 3) Video Color : R, G, B Analog
 - 4) Signal Format : Refer to the Timing Chart
- 2-3. Signal Connector
 - 3 row 15-pin Connector (Attached)
- 2-4. Scanning Frequency
 - Horizontal : 30 ~ 70 kHz
 - Vertical : 50 ~ 160 Hz

3. POWER SUPPLY

- 3-1. Power Range
 - AC 110~220V (Free Voltage), 60Hz, 2.0A Max.

3-2. Power Consumption

MODE	POWER CONSUMPTION	LED COLOR
NORMAL (ON)	73 W	GREEN
STAND-BY	less than 15 W	AMBER
SUSPEND	less than 15 W	AMBER
OFF	less than 5 W	AMBER

4. DISPLAY AREA

- 4-1. Active Video Area :
 - Max Image Size - 325.4 x 244.1 mm (12.81" x 9.61")
 - Preset Image Size - 310 x 230 mm (12.20" x 9.06")
- 4-2. Display Color : Full Colors
- 4-3. Display Resolution : 1280 x 1024 / 60Hz(Max)
(Non-Interlace)
- 4-4. Video Bandwidth : 110 MHz

5. ENVIRONMENT

- 5-1. Operating Temperature: 0°C ~ 40°C
(Ambient)
- 5-2. Relative Humidity : 10%~ 90%
(Non-condensing)
- 5-3. Altitude : 5,000 m

6. DIMENSIONS (with TILT/SWIVEL)

- Width : 415 mm (16.34 inch)
- Depth : 432 mm (17.00 inch)
- Height : 413 mm (16.25 inch)

7. WEIGHT (with TILT/SWIVEL)

- Net Weight : 17.0 kg (37.48 lbs.)
- Gross Weight : 19.5 kg (42.99 lbs.)

SAFETY PRECAUTIONS

SAFETY-RELATED COMPONENT WARNING!

There are special components used in this color monitor which are important for safety. **These parts are marked  on the schematic diagram and the replacement parts list.** It is essential that these critical parts should be replaced with the manufacturer's specified parts to prevent X-radiation, shock, fire, or other hazards. Do not modify the original design without obtaining written permission from manufacturer or you will void the original parts and labor guarantee.

CAUTION: No modification of any circuit should be attempted.

Service work should be performed only after you are thoroughly familiar with all of the following safety checks and servicing guidelines.

SAFETY CHECK

Care should be taken while servicing this color monitor because of the high voltage used in the deflection circuits. These voltages are exposed in such areas as the associated flyback and yoke circuits.

FIRE & SHOCK HAZARD

An isolation transformer must be inserted between the color monitor and AC power line before servicing the chassis.

- In servicing, attention must be paid to the original lead dress specially in the high voltage circuit. If a short circuit is found, replace all parts which have been overheated as a result of the short circuit.
- All the protective devices must be reinstalled per the original design.
- Soldering must be inspected for the cold solder joints, frayed leads, damaged insulation, solder splashes, or the sharp points. Be sure to remove all foreign materials.

IMPLOSION PROTECTION

All used display tubes are equipped with an integral implosion protection system, but care should be taken to avoid damage and scratching during installation. Use only same type display tubes.

X-RADIATION

The only potential source of X-radiation is the picture tube. However, when the high voltage circuitry is operating properly there is no possibility of an X-radiation problem. The basic precaution which must be exercised is keep the high voltage at the factory recommended level; the normal high voltage is about 26kV. The following steps describe how to measure the high voltage and how to prevent X-radiation.

Note : It is important to use an accurate high voltage meter calibrated periodically.

- To measure the high voltage, use a high impedance high voltage meter, connect (-) to chassis and (+) to the CDT anode cap.
- Set the brightness control to maximum point at full white pattern.
- Measure the high voltage. The high voltage meter should be indicated at the factory recommended level.
- If the meter indication exceeds the maximum level, immediate service is required to prevent the possibility of premature component failure.
- To prevent X-radiation possibility, it is essential to use the specified picture tube.

CAUTION:

Please use only a plastic screwdriver to protect yourself from shock hazard during service operation.

TIMING CHART

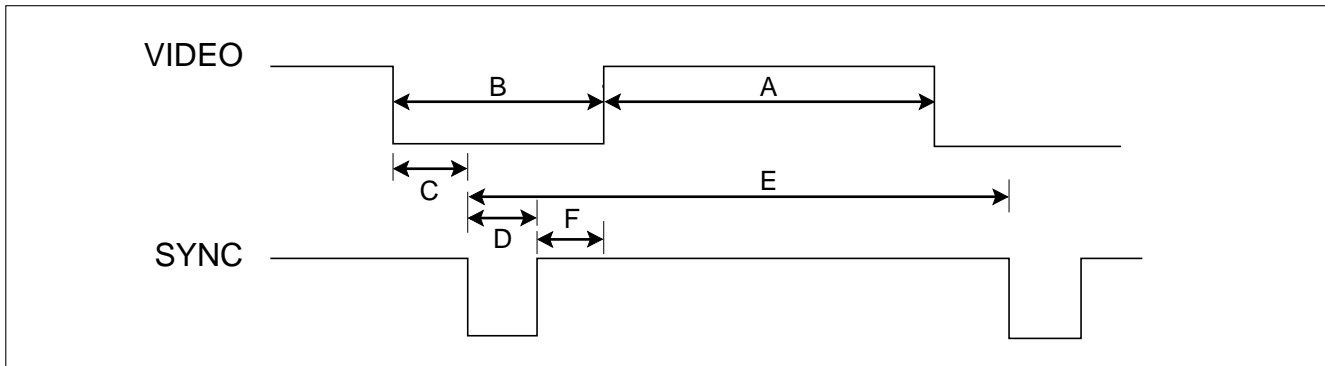

<< Dot Clock (MHz), Horizontal Frequency (kHz), Vertical Frequency (Hz), Horizontal etc... (μs), Vertical etc... (ms) >>

Mode	H/V Sort	Sync Polarity	Frequency	Total Period (E)	Video Active Time (A)	Blanking Time (B)	Sync Duration (D)	Back Porch (F)	Front Porch (C)	Resolution
1	H	-	37.50	26.67	20.32	6.35	2.03	3.81	0.51	640x480 75Hz
	V	-	74.99	13.335	12.802	0.533	0.080	0.427	0.026	
2	H	+	46.88	21.33	16.16	5.17	1.62	3.23	0.32	800x600 75Hz
	V	+	75.01	13.331	12.798	0.533	0.064	0.448	0.021	
3	H	+	53.68	18.63	14.22	4.41	1.14	2.70	0.57	800x600 85Hz
	V	+	85.07	11.755	11.178	0.577	0.056	0.503	0.018	
4	H	+	68.677	14.561	10.836	3.725	1.016	2.201	0.508	1024x768 85Hz
	V	+	85.00	11.764	11.182	0.582	0.044	0.524	0.014	

* Mode 1~Mode 4: Basic Mode

OPERATING INSTRUCTIONS

FRONT VIEW

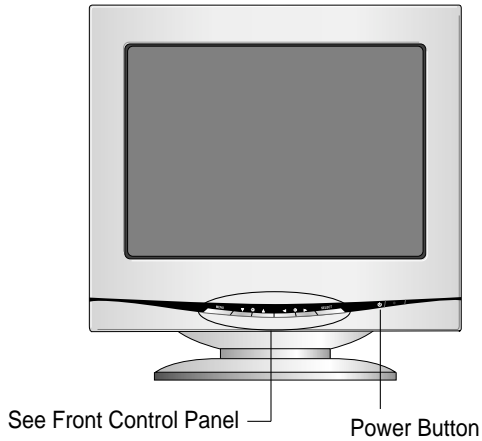

REAR VIEW

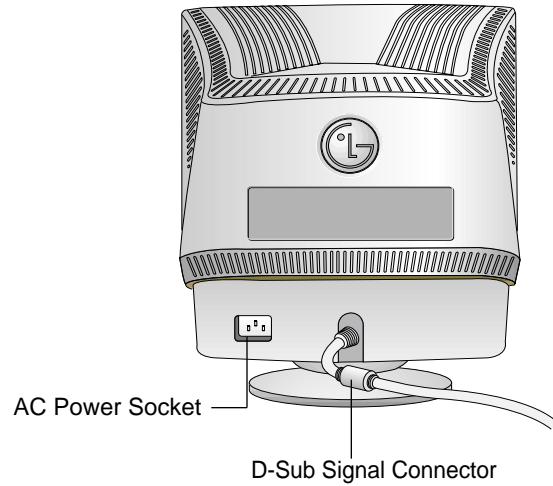

Front Control Panel

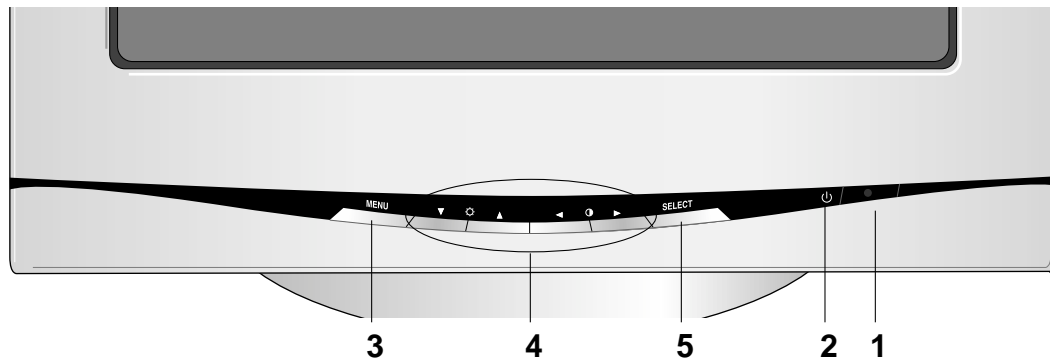

1. Power Button

This button is used to turn the monitor ON and OFF.

2. Power Indicator

This Indicator lights up green when the monitor operates normally. If the monitor is in DPM (Energy Saving) mode, this indicator color changes to amber.

3. MENU (or OSD) Button

Use this button to enter or exit the on screen display.

4. ▲▼/◀▶ Button

Use these buttons to choose or adjust items in the on screen display.

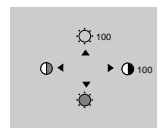

The Contrast and Brightness functions are also available in the On Screen Display (OSD) menu.

5. SELECT (or SET) Button

Use this button to enter a selection in the on screen display..

WIRING DIAGRAM

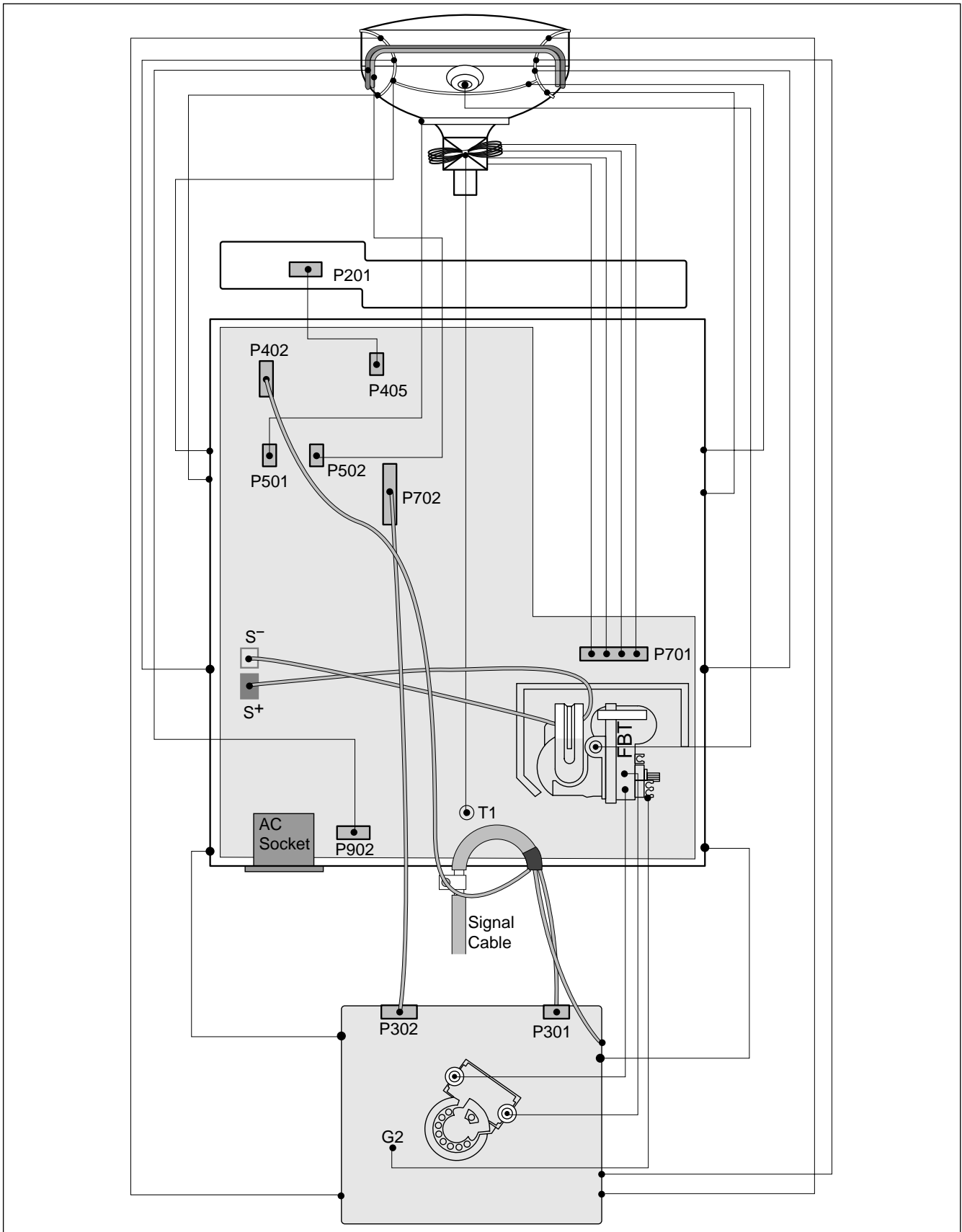

DISASSEMBLY

1. TILT/SWIVEL & BACK COVER REMOVAL

- 1) Set the monitor face downward.
- 2) Carefully remove the Tilt/Swivel by pulling it upward.
- 3) Pressing the latch (a), Back cover by pushing it upward. (See Figure. 1)
- 4) Release the latch (b). (See Figure. 2 and Tip Spec.)
- 5) Slide the Back Cover away from the Front Cabinet of the monitor.

Figure. 1

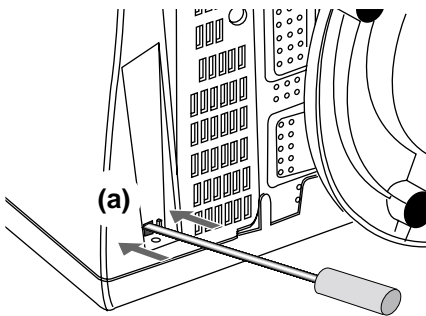
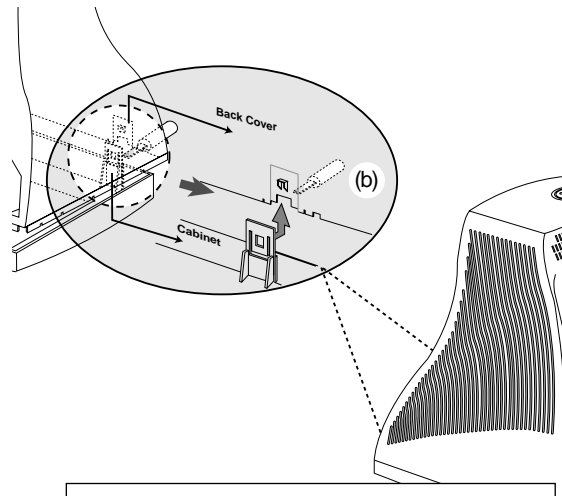

Figure. 2



Tip Spec.

A(Width) : 5.0~15.0mm

B(Depth) : 0.6~0.9mm

C(Height) : 12.0mm

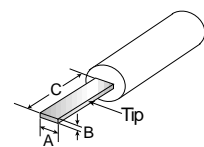

2. TOTAL CHASSIS ASSEMBLY REMOVAL

- 1) Set the monitor face downward.
- 2) Pressing the latch (a), Main Chassis by pushing it upward.

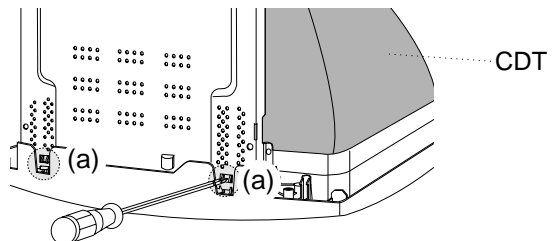

BLOCK DIAGRAM

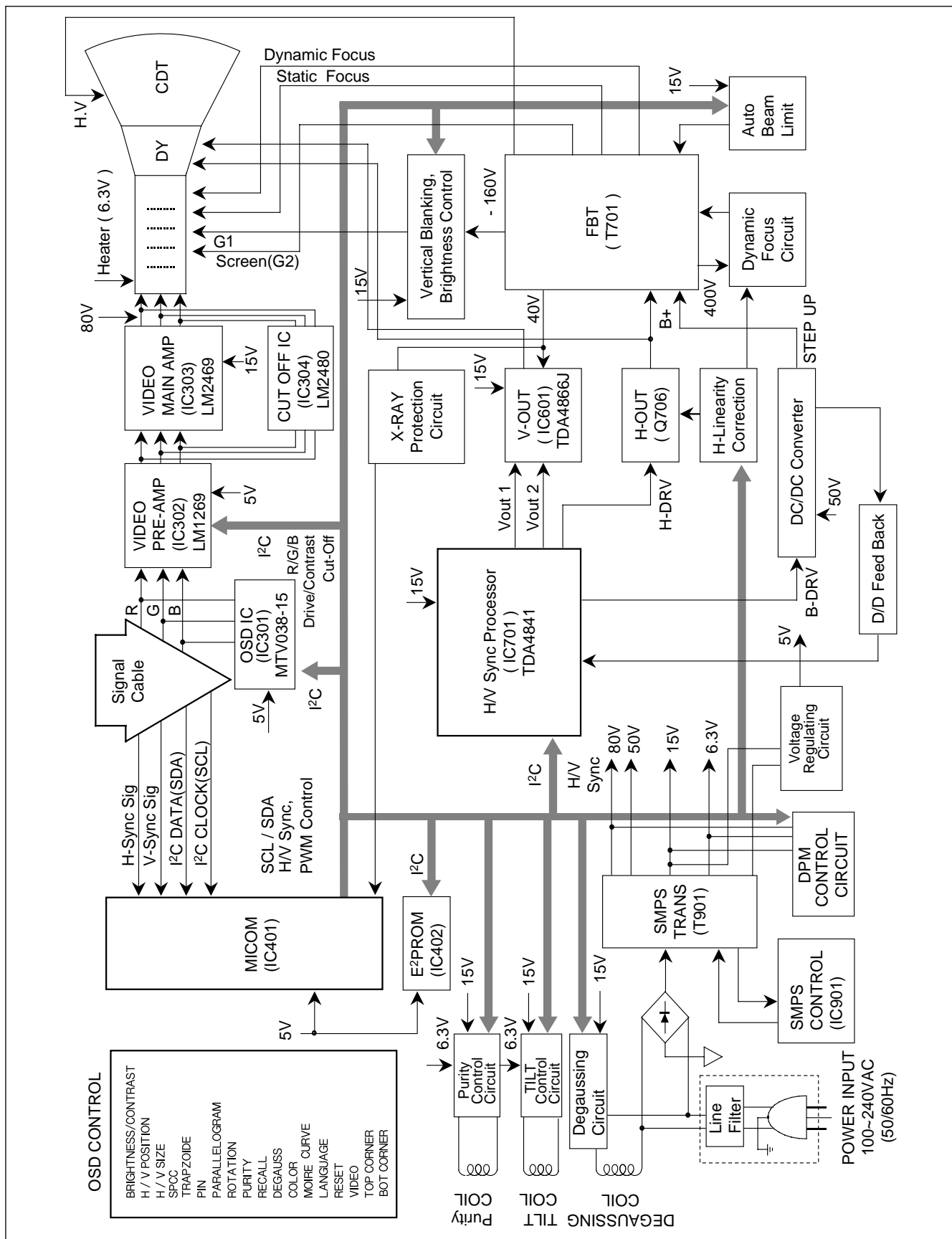

DESCRIPTION OF BLOCK DIAGRAM

1. Line Filter & Associated Circuit.

This is used for suppressing noise of power input line flowing into the monitor and/or some noise generated in this monitor flowing out through the power input line.

That is to say, this circuit prevents interference between the monitor and other electric appliances.

2. Degauss Circuit & Coil.

The degauss circuit consists of the degaussing coil, the PTC(Positive Temperature Coefficient) thermistor(TH901), and the relay(RL901). This circuit eliminates abnormal color of the screen automatically by degaussing the shadow mask in the CRT during turning on the power switch. When you need to degauss in using the monitor, select DEGAUSS on the OSD menu.

3. SMPS(Switching Mode Power Supply).

This circuit is working of 90~264V AC(50/60Hz).

The operation procedure is as follows:

- 1) AC input voltage is rectified and smoothed by the bridge diodes (D900) and the capacitor (C908).
- 2) The rectified voltage(DC) is applied to the primary coil of the transformer(T901).
- 3) The control IC(IC901) generates switching pulse to turn on and off the primary coil of the transformer (T901) repeatedly.
- 4) Depending on turn ratio of the transformer, the secondary voltages appear at the secondary coils of the transformer(T901).
- 5) These secondary voltages are rectified by each diode(D941, D942, D951, D961, D962, D971) and operate other circuit. (horizontal and vertical deflection, video amplifier, ...etc.)

4. X-ray Protection.

If the high voltage of the FBT reaches up to 29kV (abnormal state), IC401(MICOM) pin 35 Sensing from FBT directly.

Then MICOM control IC701 (Deflection controller) to stop Horizontal drive pulse and stop Horizontal Deflection.

5. Micom(Microprocessor) Circuit.

The operating procedure of Micom(Microprocessor) and its associated circuit is as follows:

- 1) H and V sync signal is supplied from the signal cable.
- 2) The Micom(IC401) distinguishes polarity and frequency of H and V sync.
- 3) The Micom sets operating mode and offers the controlled data. (H-size, H-position, V-size, ... etc.)
- 4) The controlled data of each mode is stored in itself.
- 5) User can adjust screen condition by each OSD function. The data of the adjusted condition is stored in EEPROM(IC402).

6. Horizontal and Vertical Oscillation.

This circuit generates the horizontal pulse and the vertical pulse by taking the H and V sync signal.

This circuit consists of the TDA4841(IC701) and the associated circuit.

7. D/D(DC to DC) Converter.

This circuit supplies DC voltage to the horizontal deflection output circuit by increasing DC 50V which is the secondary voltage of the SMPS in accordance with the input horizontal sync signal.

8. Side-Pincushion & Trapezoid Correction Circuit.

This circuit improves the side-pincushion and the trapezoid distortion of the screen by mixing parabola and saw-tooth wave to output of the horizontal deflection D/D converter which is used for the supply voltage(B +) of the deflection circuit.

9. Horizontal Deflection Output Circuit.

This circuit makes the horizontal deflection by supplying the saw-tooth current to the horizontal deflection yoke.

10. High Voltage Output & FBT(Flyback Transformer).

The high voltage output circuit is used for generating pulse to the primary coil of the FBT(Flyback Transformer) secondary of the FBT and it is supplied to the anode, focus, and screen voltage of the CRT.

11. H-Linearity Correction Circuit.

This circuit corrects the horizontal linearity for each horizontal sync frequency.

12. Vertical Output Circuit.

This circuit takes the vertical ramp wave from the TDA4841(IC701) and performs the vertical deflection by supplying the saw-tooth current to the vertical deflection yoke.

13. Dynamic Focus Output Circuit.

This circuit takes the horizontal and the vertical parabola waves from the TDA4841(IC701) and amplifies it to maintain constant focus on center and corners in the screen.

14. H & V Blanking and Brightness Control.

Blanking circuit eliminates retrace line by supplying negative pulse to the G1 of the CRT. And Brightness circuit is used for control of the screen brightness by changing DC level of the G1.

15. Image Rotation (Tilt) Circuit.

This circuit corrects the tilt of the screen by supplying the image rotation signal to the tilt coil which is attached near the deflection yoke of the CRT.

16. Video Pre-Amp Circuit.

This circuit amplifies the analog video signal from 0-0.7V to 0-4V. It is operated by taking the clamp, R, G, B drive and contrast signal from the Micom(IC401).

17. Video Output Amp Circuit.

This circuit amplifies the video signal which comes from the video pre-amp circuit and amplified it to applied the CRT cathode.

ADJUSTMENT

GENERAL INFORMATION

All adjustment are thoroughly checked and corrected when the monitor leaves the factory, but sometimes several adjustments may be required.

Adjustment should be following procedure and after warming up for a minimum of 30 minutes.

- Alignment appliances and tools.
 - IBM compatible PC.
 - Programmable Signal Generator.
(eg. VG-819 made by Astrodesign Co.)
 - EPROM or EEPROM with saved each mode data.
 - Alignment Adaptor and Software.
 - Digital Voltmeter.
 - White Balance Meter.
 - Luminance Meter.
 - High-voltage Meter.

AUTOMATIC AND MANUAL DEGAUSSING

The degaussing coil is mounted around the CDT so that automatic degaussing when turn on the monitor. But a monitor is moved or faced in a different direction, become poor color purity cause of CDT magnetized, then press DEGAUSS on the OSD menu.

ADJUSTMENT PROCEDURE & METHOD

- Install the cable for adjustment such as Figure 1 and run the alignment program on the DOS for IBM compatible PC.
- Set external Brightness and Contrast volume to max position.

1. Adjustment for High-Voltage.

- 1) Display cross hatch pattern at Mode 4.
- 2) DIST.ADJ→CTRL PWM → High Voltage Command.
- 3) Adjust High Voltage to 25.5kV±0.1 kVdc.
- 4) Press Enter Key.

2. Adjustment for Factory Mode (Preset Mode).

- 1) Display cross hatch pattern at Mode 1.
- 2) Run alignment program for FB770G on the IBM compatible PC.
- 3) EEPROM → ALL CLEAR → Y(Yes) command.
<Caution> Do not run this procedure unless the EEPROM is changed. All data in EEPROM (mode data and color data) will be erased.
- 4) Power button of the monitor turn off → turn on.
- 5) COMMAND→PRESET START→Y(Yes) command.
- 6) DIST. ADJ. → CTRL PWM → TILT command.
- 7) Adjust tilt as arrow keys to be the best condition.
- 8) DIST. ADJ. → BALANCE command.
- 9) Adjust parallelogram as arrow keys to be the best condition.

- 10) Adjust balance of pin-balance as arrow keys to be the best condition.
- 11) DIST. ADJ. → FOS. ADJ command.
- 12) Adjust V-SIZE as arrow keys to 230±2mm.
- 13) Adjust V-POSITION as arrow keys to center of the screen.
- 14) Adjust H-SIZE as arrow keys to 310±2mm.
- 15) Adjust H-POSITION as arrow keys to center of the screen.
- 16) Adjust S-PCC (Side-Pincushion) as arrow keys to be the best condition.
- 17) Adjust TRAPEZOID as arrow keys to be the best condition.
- 18) Save of the Mode 1.
- 19) Display from Mode 2 to 4 and repeat above from number 12) to 19)
- 20) PRESET EXIT → Y (Yes) command.

3. Adjustment for White Balance and Luminance.

- 1) Set the White Balance Meter.
- 2) Press the DEGAUSS on the OSD menu for demagnetization of the CDT.
- 3) COLOR ADJ. → LUMINANCE command of the alignment program.
- 4) Set Brightness and Contrast to Max position.
- 5) Display color 0,0 pattern at Mode 4.
- 6) COLOR ADJ.→ BIAS ADJ.→ COLOR No. → 1 command of the alignment program.
- 7) Check whether green color or not at R-BIAS and G-BIAS to min position and B-BIAS to 127(7F) and Sub-Brightness to 177(B1) position. Adjust G2 (screen) command to 0.4± 0.05FL of the raster luminance.
- 8) Adjust R-BIAS and G-BIAS command to x=0.283± 0.005 and y=0.298±0.005 on the White Balance Meter with PC arrow keys.
- 9) Adjust SUB-Brightness command to 0.4±0.1FL of the raster luminance.
- 10) Adjust repeat number 8).
- 11) After push the "ENTER" key.
- 11-1) COMMAND → PRESET START → Y(Yes) command.
- 12) Display color 15,0 full white pattern at Mode 4.
- 13) DRIVE ADJ.→ No 1. command.
- 14) Set Brightness and Contrast to Max position.
- 15) Set SUB-CONTRAST Max 127(7F) (decimal) position.
- 16) Set B-DRIVE to 100(64) at DRIVE of the alignment program.

- 17-1) Adjust R-DRIVE and G-DRIVE command to white balance $x=0.283\pm 0.003$ and $y=0.298\pm 0.003$ on the White Balance Meter with PC arrow keys.
- 17-2) Display color 15,0 window pattern (70x70mm) at mode 4.
 - 18) Adjust SUB-CONTRAST command to $50\pm 2FL$.
 - 19) Display color 15,0 full white pattern at Mode 4.
 - 20) Set Brightness and Contrast to Max position.
 - 21) COLOR ADJ. → LUMINANCE → ABL command.
 - 22) Adjust ABL to $32\pm 1FL$ of the luminance.
 - 23) After push the "ENTER" key, and "COMMAND → PRESET EXIT → Y(Yes)" command.
 - 24) Exit from the program.

4. Input EDID Data.

- 1) Display color 15,0 cross hatch pattern at Mode 4.
- 2) EEPROM → Write EDID command and confirm "EDID Write OK!!" message of monitor.
- 3) Exit from the alignment program.
- 4) Power switch OFF/ON for EDID data save.

5. Adjustment for Focus.

- 1) Set the Brightness and Contrast to max position.
- 2) Display H character in full screen at Mode 4.
- 3) Adjust two Focus control on the FBT that focus should be the best condition.

TROUBLESHOOTING GUIDE

1. NO POWER

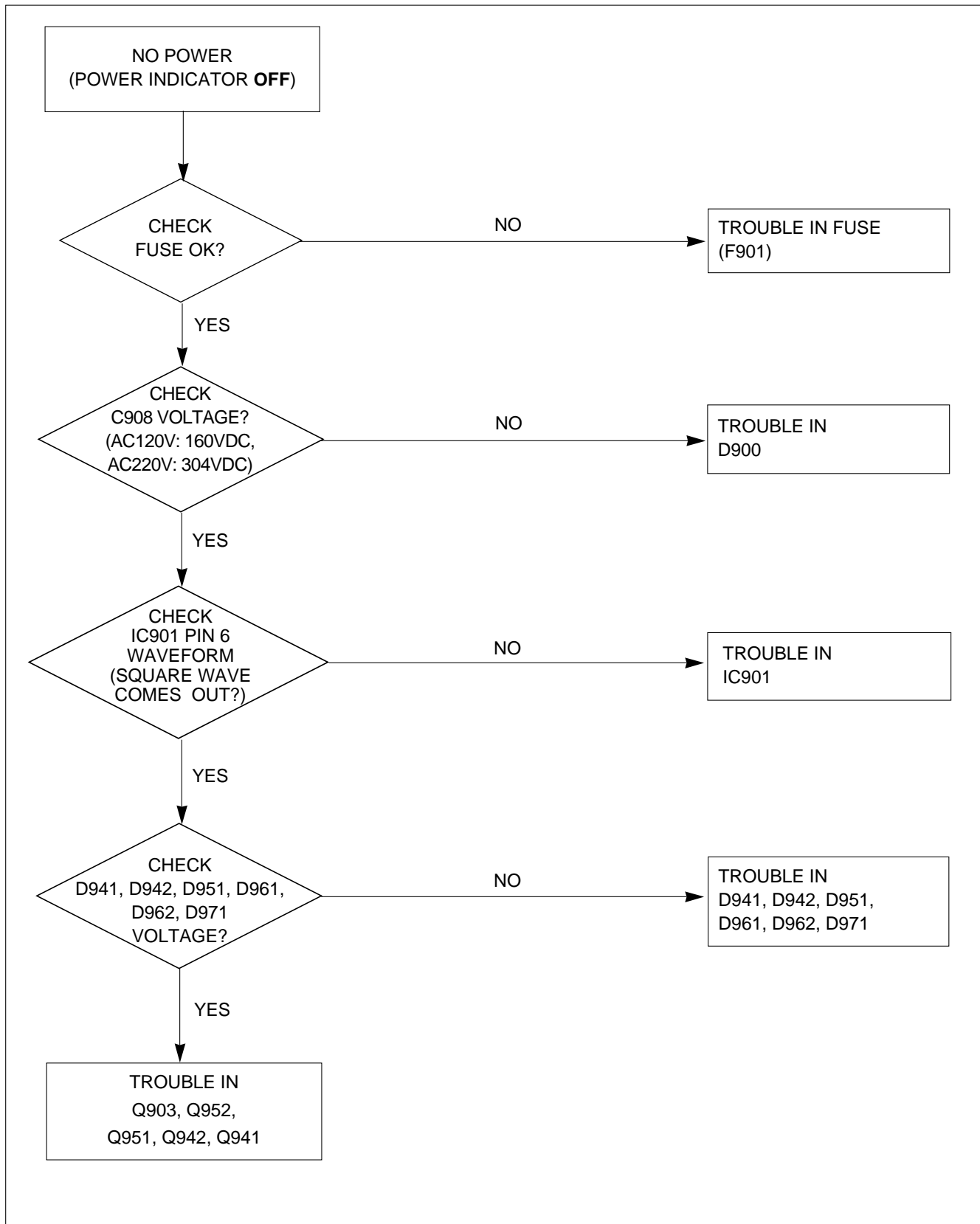

2. NO CHARACTER

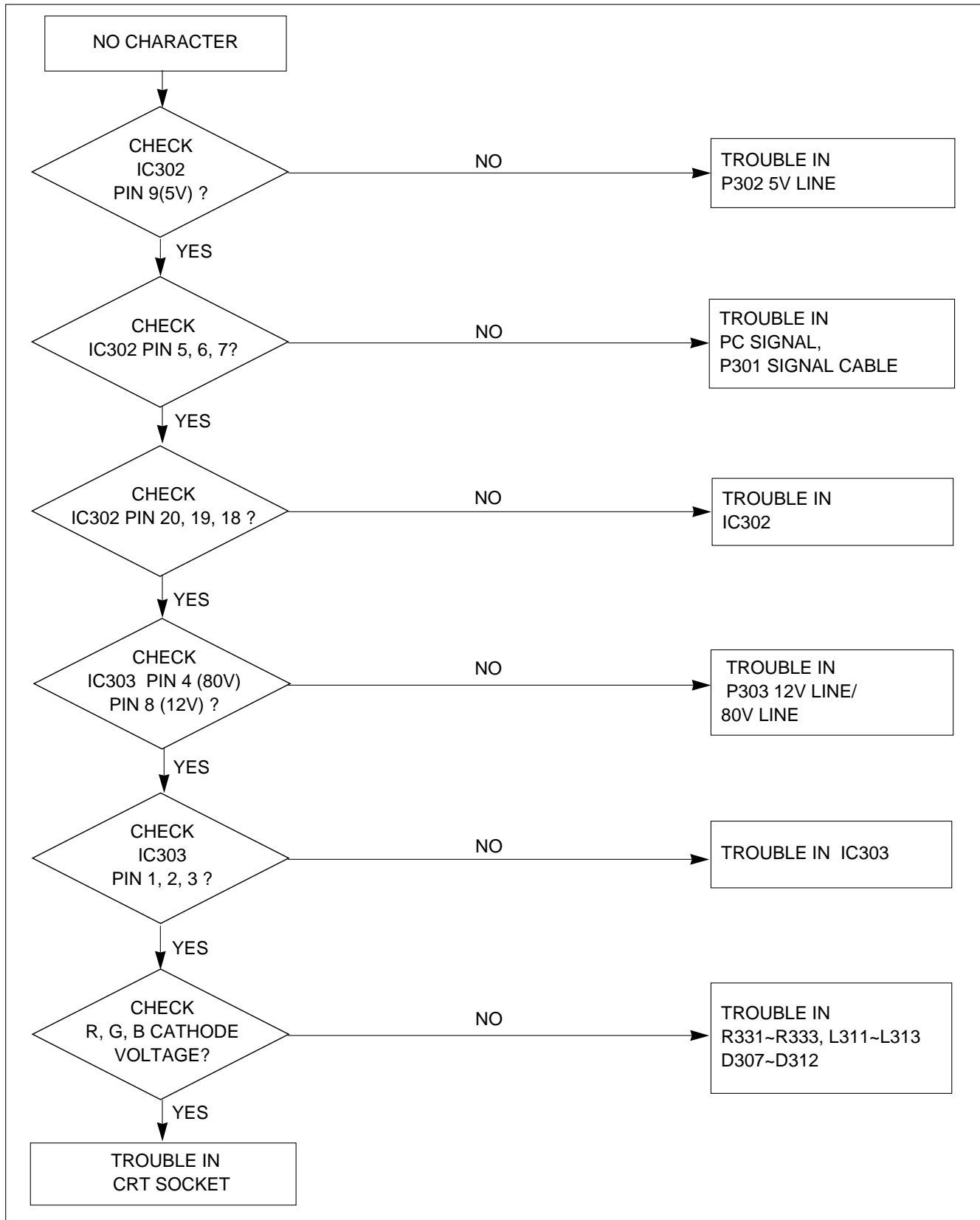

3. NO RASTER

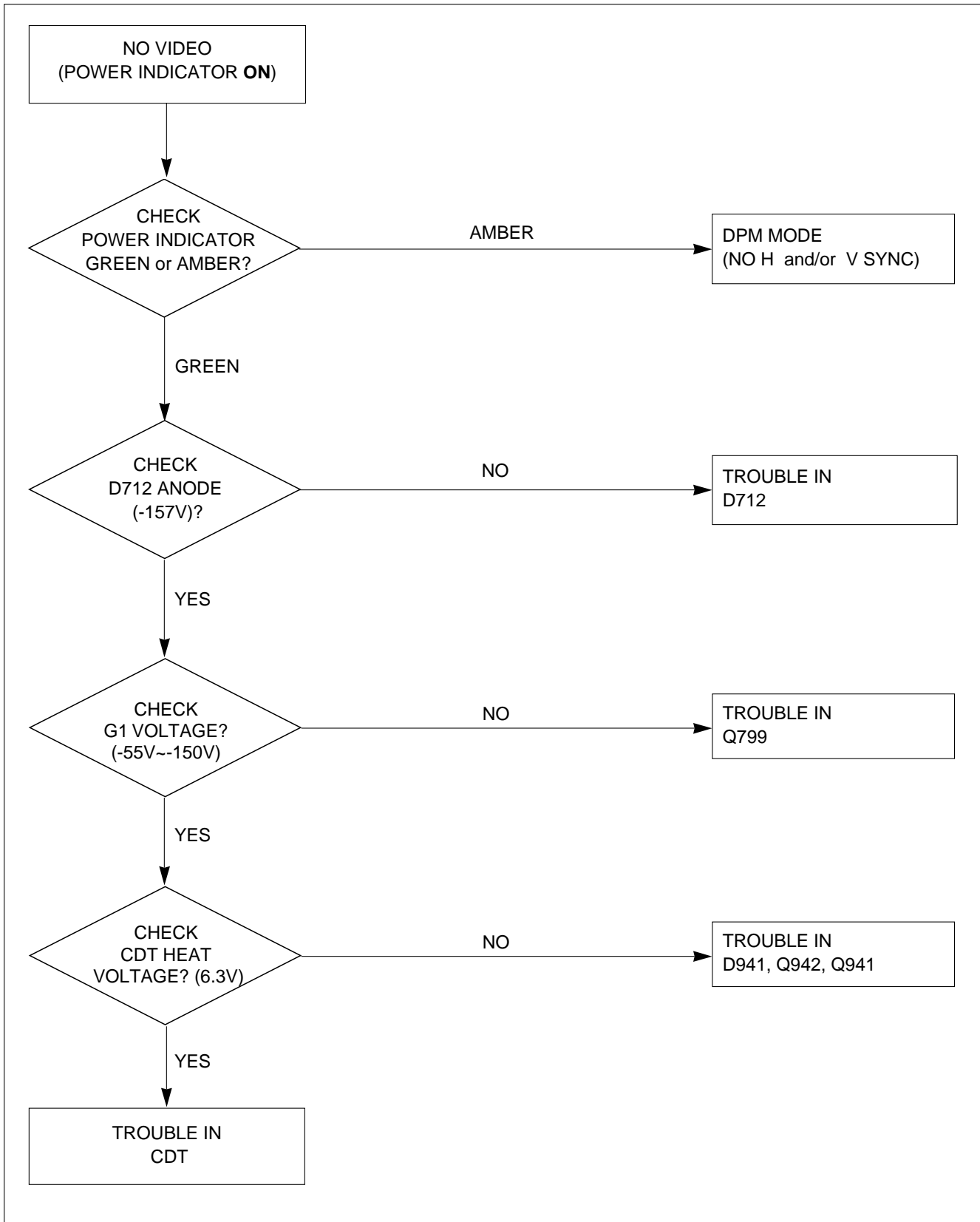

4. NO HORIZONTAL DEFLECTION

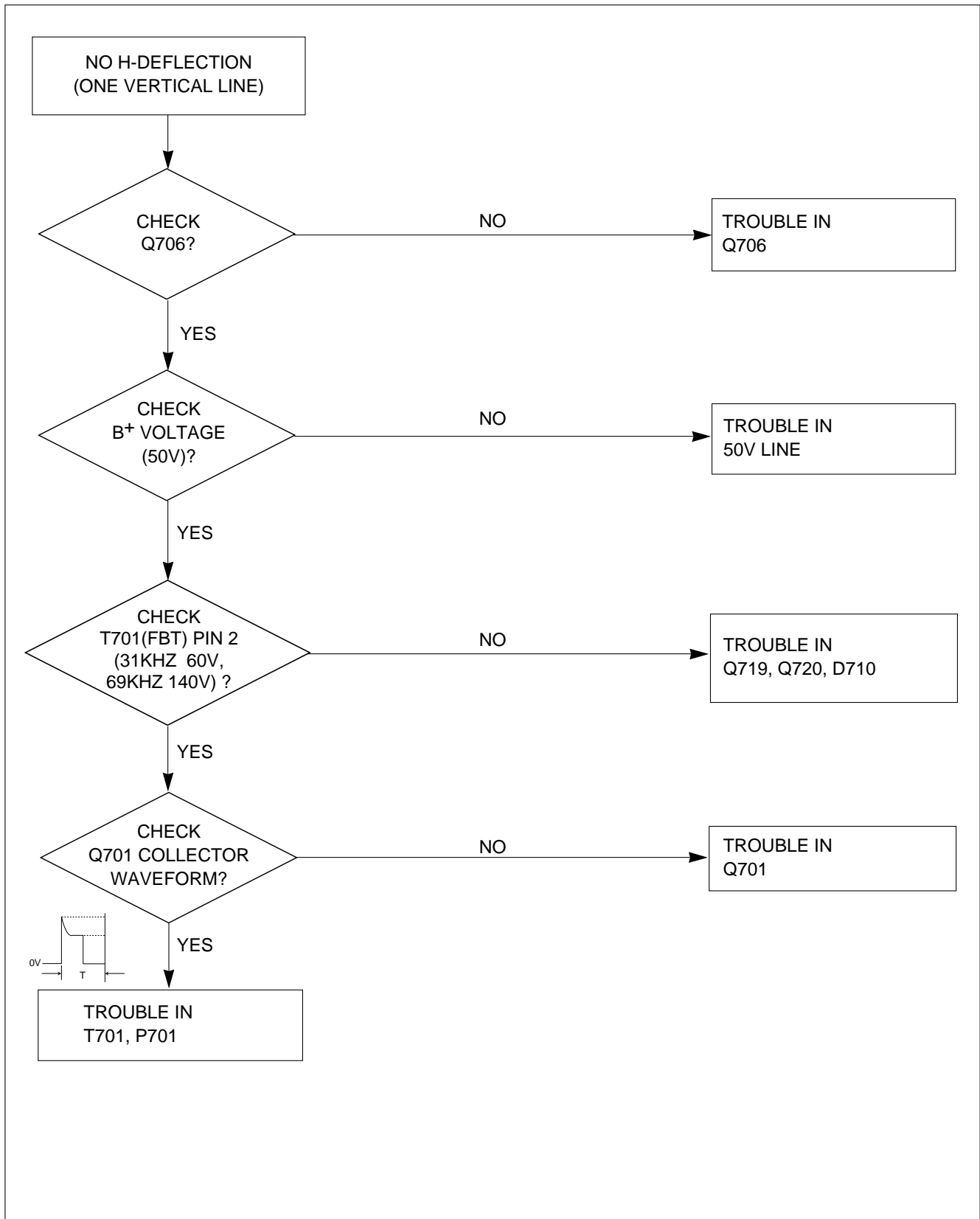

5. TROUBLE IN H-LINEARITY

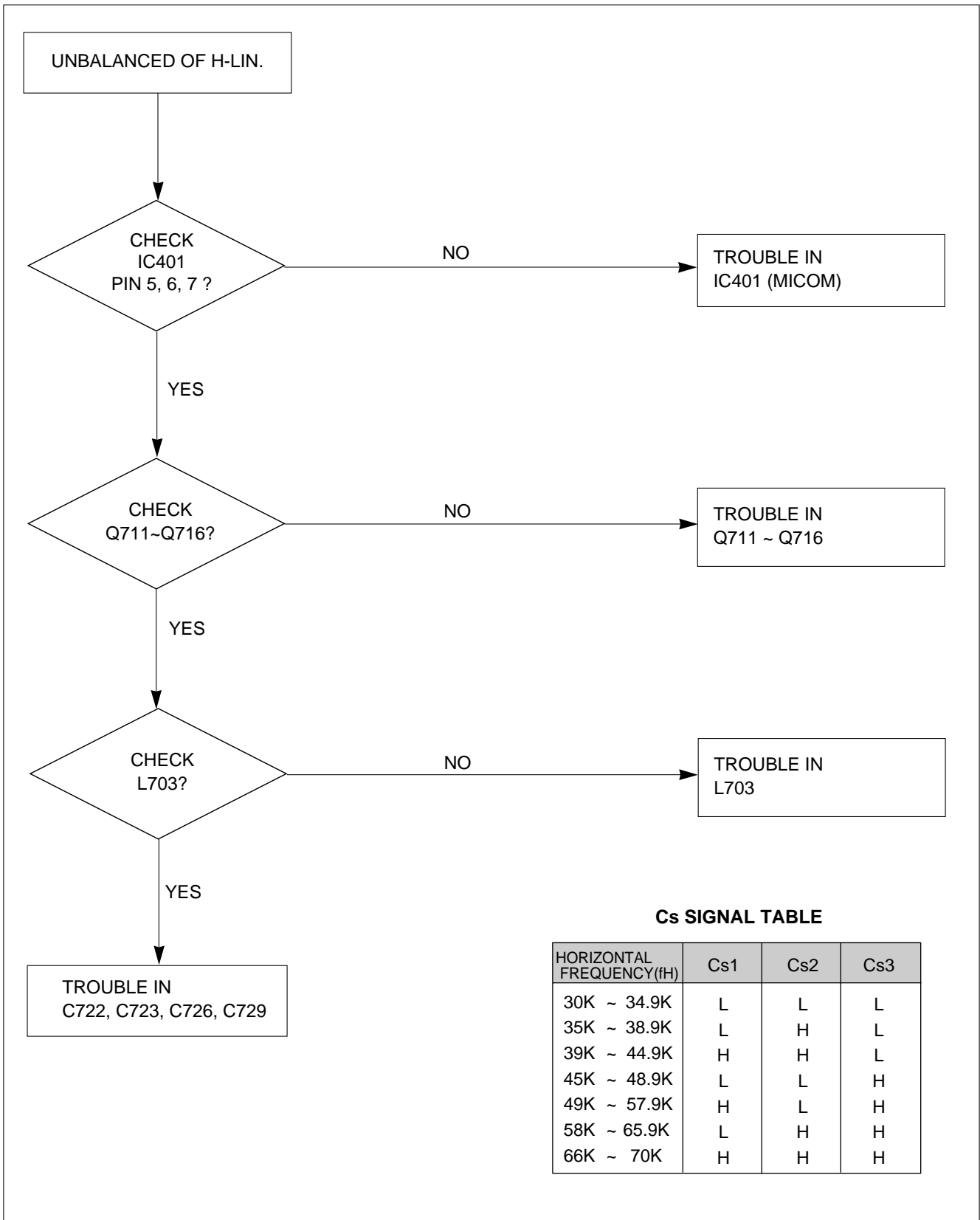

Cs SIGNAL TABLE

HORIZONTAL FREQUENCY(fH)	Cs1	Cs2	Cs3
30K ~ 34.9K	L	L	L
35K ~ 38.9K	L	H	L
39K ~ 44.9K	H	H	L
45K ~ 48.9K	L	L	H
49K ~ 57.9K	H	L	H
58K ~ 65.9K	L	H	H
66K ~ 70K	H	H	H

6. NO VERTICAL DEFLECTION

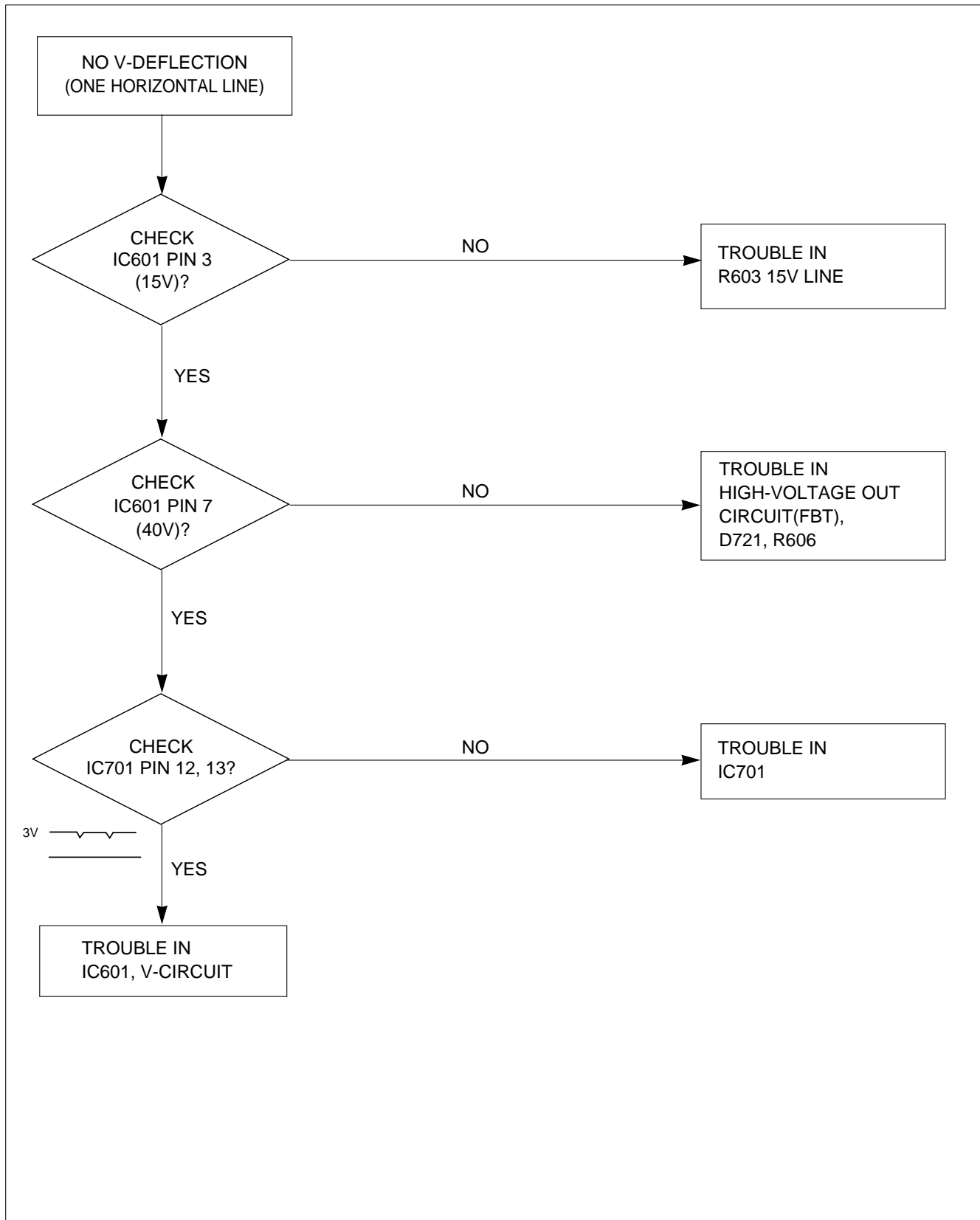

7. TROUBLE IN OSD

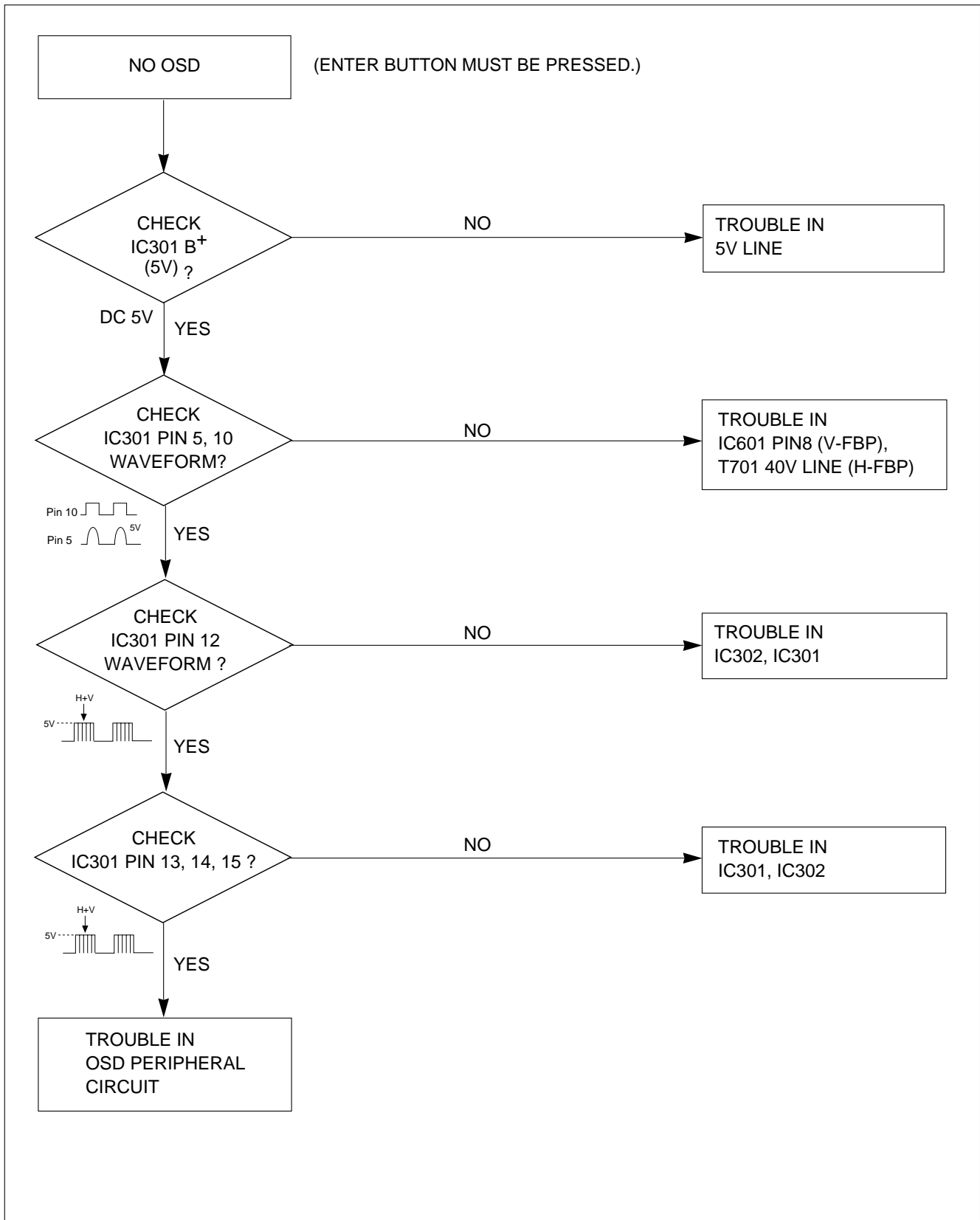

8. TROUBLE IN DPM

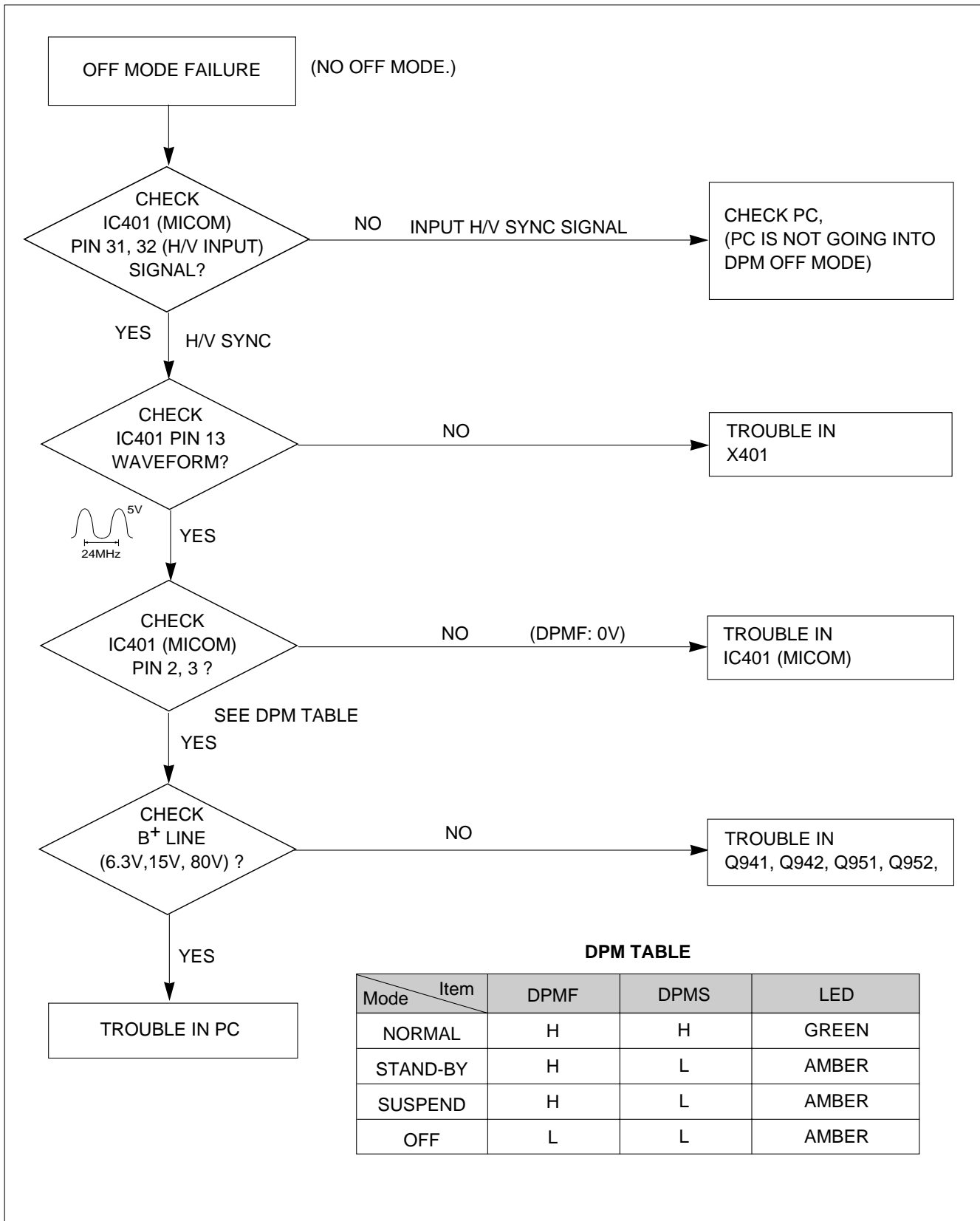

DPM TABLE

Mode \ Item	DPMF	DPMS	LED
NORMAL	H	H	GREEN
STAND-BY	H	L	AMBER
SUSPEND	H	L	AMBER
OFF	L	L	AMBER

9. NO DEGAUSSING

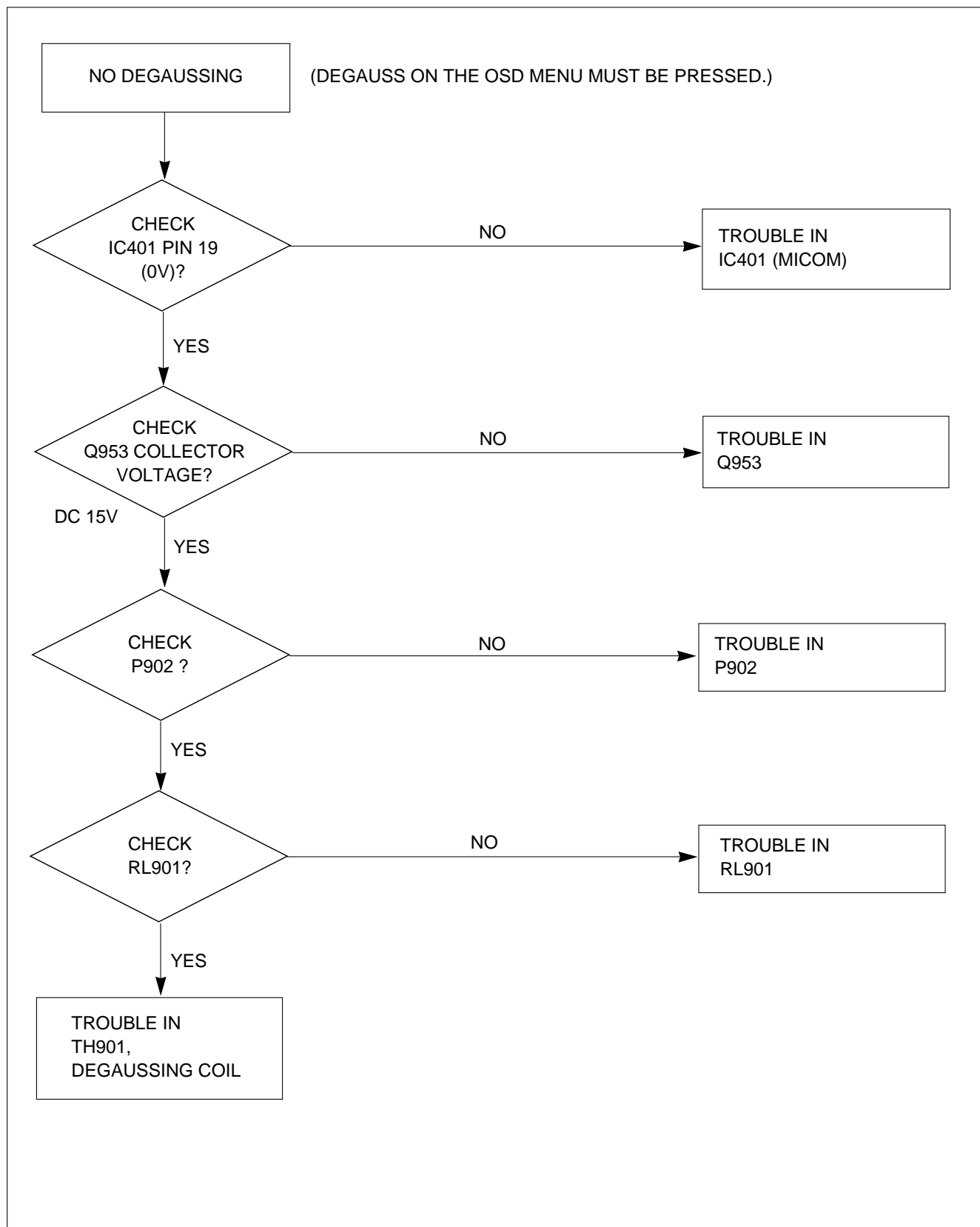

10. NO TILT (NO ROTATION)

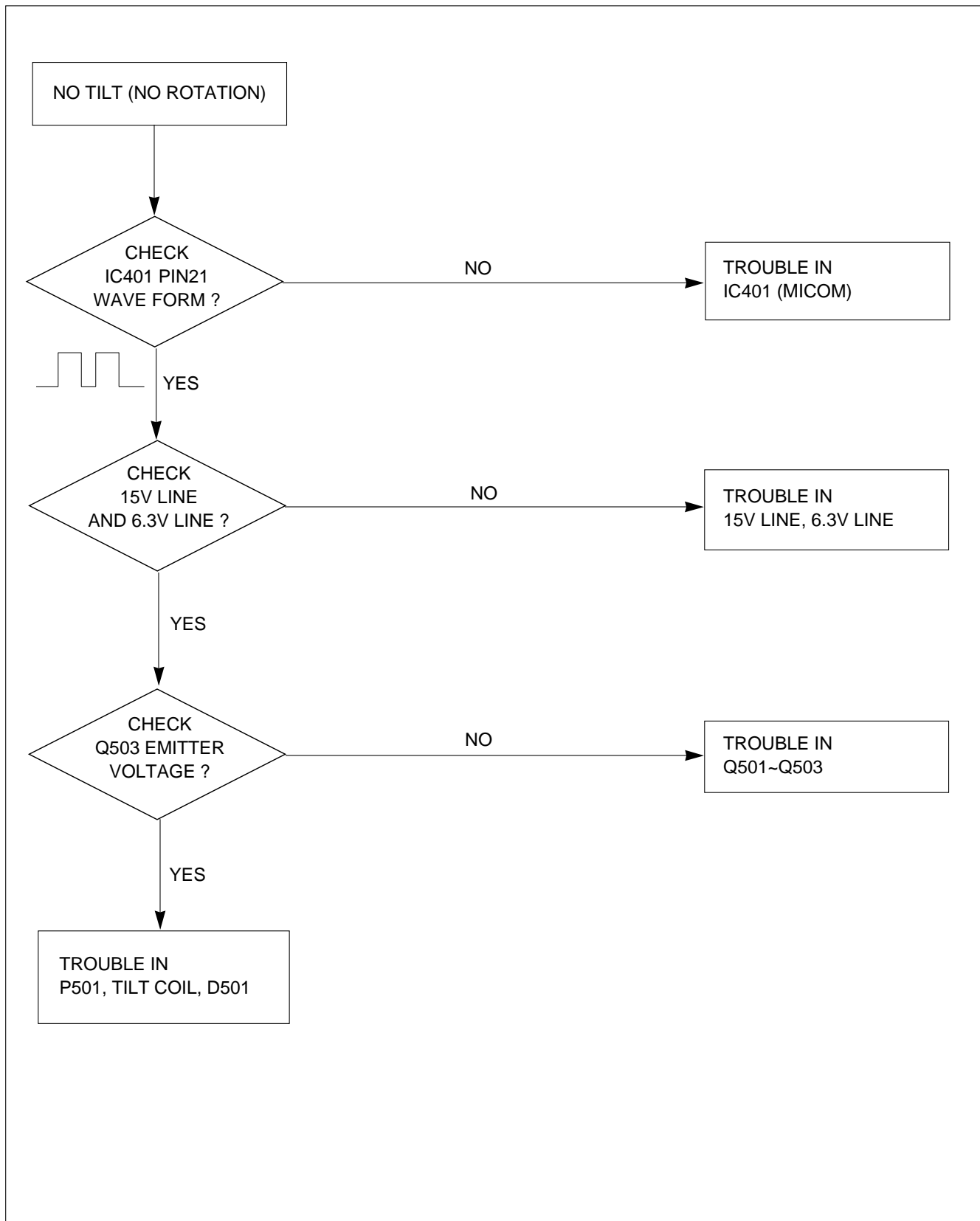

EXPLODED VIEW

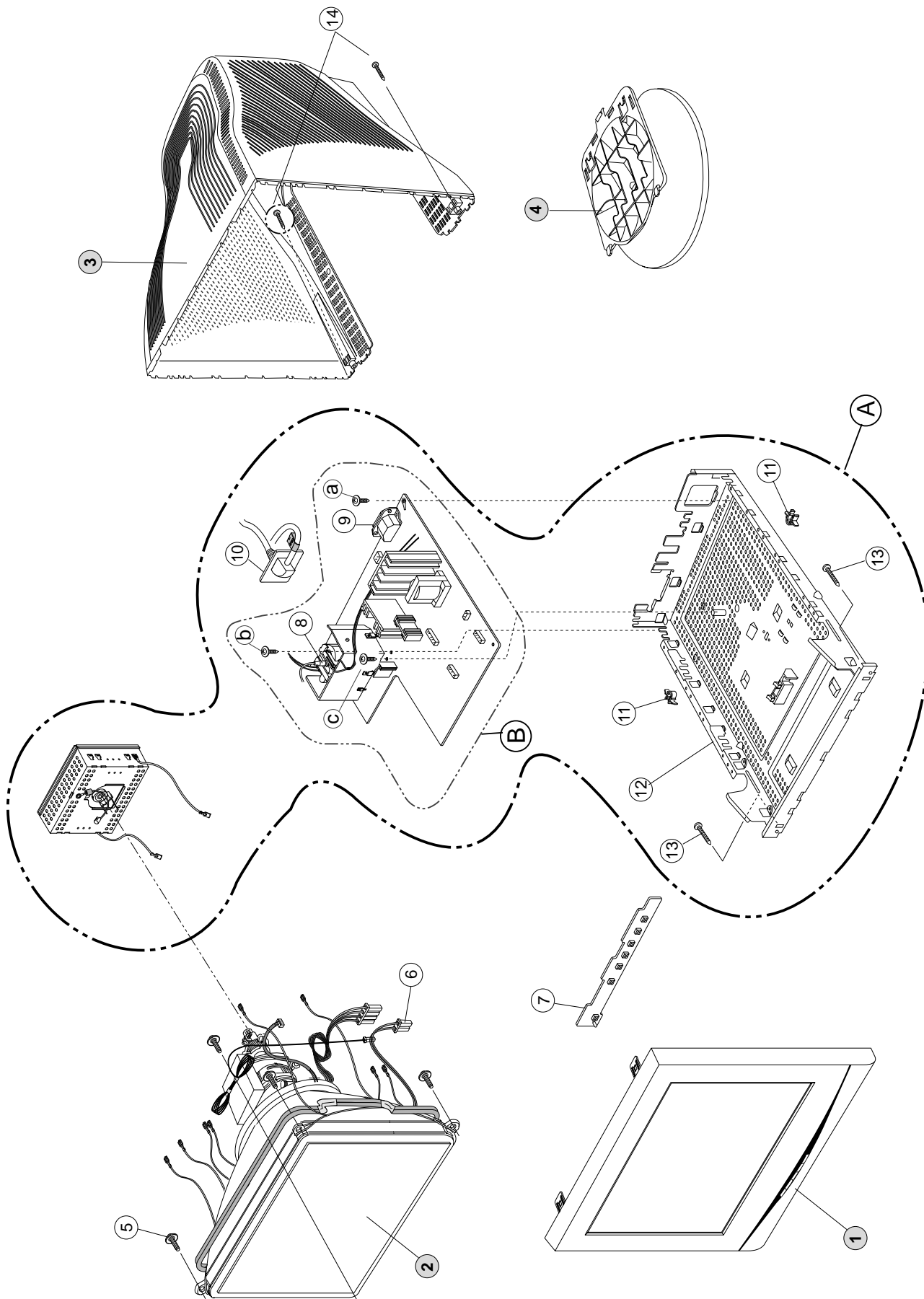

EXPLODED VIEW PARTS LIST

Ref. No.	Part No.	Description
1	3091TKC074F	CABINET ASSEMBLY, FB770G BRAND 068 DI F700B
	3091TKC074A	CABINET ASSEMBLY, FB770G BRAND 068 FOR JAPAN
2	2423GC3E41M	CDT(CIRC), M41QBF423X 31NPLD LG-PHILIPS Displays 70KHZ 29.1 mm For Northern Hemisphere
	or 2423GC3E41B	CDT SET, M41QBF423X 31N6LD For Northern Hemisphere
	2423GC3E41U	CDT(CIRC), M41QBF423X 32SPLD LG-PHILIPS Displays 70KHZ 29.1 mm For Southern Hemisphere
	2423GC3E41N	CDT(CIRC), M41QBF423X 31RPLD LG-PHILIPS Displays 70KHZ 29.1 mm For Equatorial
3	3809TKC042A	BACK COVER ASSEMBLY, 2ND FLATRON 3808TKC041A (17")
4	3043TKK085A	TILT SWIVEL ASSEMBLY, 2ND FLATRON 3042TKT060A
5	339-002H	SCREW ASSY, PHP+5*20(FZMY)+GW18 NEW TYPE
6	6140TC2014B	COIL,DEGAUSSING, - GET D-COIL,0.5*130TS,1410,WITH PURITY,FB770G
7	6871TST289H	PWB(PCB) ASSEMBLY,SUB, FB770G.KLEUED CONTROL TOTAL BRAND LG EDI
	6871TST289B	PWB(PCB) ASSEMBLY,SUB, FB770G.AXKGC CONTROL TOTAL BRAND FOR JAPAN
8	6174T11003E	FBT (FLY BACK TRANSFORMER), 1054A,CB777G LG-PHILIPS 17"
9	6620TKB002A	SOCKET(CIRC),POWERBAE EUN AC UNIVERSAL 3PIN BLACK
10	6850TA9006A	CABLE,D-SUB, UL 2990-9C(7.5) AT 1560MM GRAY(85964) FB775G DM
11	4930TKK031C	HOLDER, PCB FIX , PC+ABS
12	4950TKK368C	METAL BASE A-CKD,FB770G
13	332-102E	SCREW, PTP+4*16(MSWR/FZMY)
14	332-102E	SCREW, PTP+4*16(MSWR/FZMY)
A	3313T17256G	MAIN TOTAL ASSEMBLY, FB775G.KLEUED BRAND CA 193
	3313T17256K	MAIN TOTAL ASSEMBLY, FB770G BRAND CA-113 FOR JAPAN
B	6871TMT295B	PWB(PCB) ASSEMBLY,MAIN, FB775G KXLVED BRAND CA-109 TOTAL
	6871TMT295A	PWB(PCB) ASSEMBLY,MAIN, FB775G AXKGC BRAND CA-109 TOTAL FOR JAPAN
a	332-112F	SCREW,DRAWING, D3.5 L10.0 MSWR/FZMY +SW3.5+RW3.5
b	1SZZTER001D	SCREW, D3.0 L10.0 MSWR/FZMY DOUBLE
c	339-008C	SCREW ASSY MP+3*10(FZMY)+SW3+RW3

REPLACEMENT PARTS LIST

CAUTION: BEFORE REPLACING ANY OF THESE COMPONENTS,
 READ CAREFULLY THE **SAFETY PRECAUTIONS** IN THIS MANUAL.

* NOTE : **S** SAFETY Mark **AL** ALTERNATIVE PARTS

DATE: 2002. 05. 13.				
*S	*AL	LOC. NO.	PART NO.	DESCRIPTION / SPECIFICATION
CAPACITORS				
			C201	0CN1040K949 0.1M 50V Z F TA52
			C301	181-288N MKT 100V 103JTR PHS86103
			C302	0CE107CF638 100UF SHL,SD 16V M FM5 TP 5
			C303	0CK1040K945 0.1UF 50V Z F TR
			C304	0CK1030K945 0.01UF 50V Z F TR
			C305	0CE107CF638 100UF SHL,SD 16V M FM5 TP 5
			C306	181-288N MKT 100V 103JTR PHS86103
			C307	0CK3910K515 390P 50V K B TS
			C308	0CN1040K949 0.1M 50V Z F TA52
			C309	0CK1040K945 0.1UF 50V Z F TR
			C310	181-288B MKT 100V 104JTR PHS26104
			C311	0CK1040K945 0.1UF 50V Z F TR
			C312	0CN1040K949 0.1M 50V Z F TA52
			C313	0CK1040K945 0.1UF 50V Z F TR
			C314	0CC4700W405 47PF 500V J SL TP
			C315	0CE476CF638 47UF SHL,SD 16V M FM5 TP 5
			C316	0CK1010W515 100P 500V K B TS
			C317	0CN1040K949 0.1M 50V Z F TA52
			C318	0CK1040K945 0.1UF 50V Z F TR
			C319	0CN1040K949 0.1M 50V Z F TA52
			C320	0CN1040K949 0.1M 50V Z F TA52
			C321	0CE475CK638 4.7UF SHL,SD 50V M FM5 TP 5
			C322	0CN6810K519 680P 50V K B TA52
			C323	0CE476CF638 47UF SHL,SD 16V M FM5 TP 5
			C324	0CK1040K945 0.1UF 50V Z F TR
			C325	181-288B MKT 100V 104JTR PHS26104
			C326	0CE106CN638 10UF SHL,SD 100V M FM5 TP 5
			C327	181-288B MKT 100V 104JTR PHS26104
			C328	0CE106CN638 10UF SHL,SD 100V M FM5 TP 5
			C329	181-288B MKT 100V 104JTR PHS26104
			C330	181-288B MKT 100V 104JTR PHS26104
			C331	181-288G MKT 100V 334JTR PHS26334
			C332	181-288G MKT 100V 334JTR PHS26334
			C333	181-288G MKT 100V 334JTR PHS26334
			C334	181-288B MKT 100V 104JTR PHS26104
			C335	181-288B MKT 100V 104JTR PHS26104
			C336	181-288E MKT 100V 474JTR PHS 26474
			C339	0CK4710W515 470P 500V K B TS
			C340	0CK1040K945 0.1UF 50V Z F TR
			C341	0CK10302940 0.01M 2KV Z F S
			C342	0CE106CK638 10UF SHL,SD 50V M FM5 TP 5
			C346	0CK10202515 1000PF D 2KV 10% TR B(Y5P)
			C351	0CC0400K115 4P 50V D NPO TS
			C352	0CC0400K115 4P 50V D NPO TS
			C353	0CC0400K115 4P 50V D NPO TS
			C358	0CK8210K515 820P 50V K B TS
			C359	0CN5610K519 560P 50V K B TA52
			C372	0CK1040K945 0.1UF 50V Z F TR
			C401	0CN1040K949 0.1M 50V Z F TA52
			C402	0CE476CF638 47UF SHL,SD 16V M FM5 TP 5
			C403	0CK1040K945 0.1UF 50V Z F TR
			C404	0CC1800K415 18P 50V J NPO TP
			C405	0CC1800K415 18P 50V J NPO TP

DATE: 2002. 05. 13.				
*S	*AL	LOC. NO.	PART NO.	DESCRIPTION / SPECIFICATION
			C406	0CK1010K515 100PF 50V K B TR
			C407	0CK1010K515 100PF 50V K B TR
			C408	0CK1040K945 0.1UF 50V Z F TR
			C409	0CC5600K415 56P 50V J NPO TP
			C410	0CK1010K515 100PF 50V K B TR
			C411	0CK1040K945 0.1UF 50V Z F TR
			C412	0CK1040K945 0.1UF 50V Z F TR
			C413	0CK1040K945 0.1UF 50V Z F TR
			C501	0CE106CF638 10UF SHL,SD 16V M FM5 TP 5
			C510	0CE225CK638 2.2UF SHL,SD 50V M FM5 TP 5
			C511	0CE106CF638 10UF SHL,SD 16V M FM5 TP 5
			C599	0CE225CK638 2.2UF SHL,SD 50V M FM5 TP 5
			C601	0CE477EH618 470UF KMG 25V M FL TP 5
			C602	181-288B MKT 100V 104JTR PHS26104
			C603	0CE476CK638 47UF SHL,SD 50V M FM5 TP 5
			C604-1	181-288T MKT 100V 223KTR PHS85223
			C605	0CK1020W515 1000P 500V K B TS
			C701	0CQ5621N419 5600P 100V J POLY NI TP
			C702	0CZZTFT001M ECQB1H103JM3 103J 50V TP5.0 MA
			C703	0CZZTFT001Z ECQB1H104JM3 104J 50V TP5.0 MA
			C704	0CQ8221N519 0.0082U 100V K POLY NI TP
			C705	0CE476CF638 47UF SHL,SD 16V M FM5 TP 5
			C706	0CZZTFT001Z ECQB1H104JM3 104J 50V TP5.0 MA
			C707	0CZZTFT002B ECQV1H154JZ3 154J 50V TP5.0 MA
			C708	0CE227CH638 220UF SHL,SD 25V M FM5 TP 5
			C709	181-288P MKT 100V 153JTR PHS86153
			C711	0CQ5621N419 5600P 100V J POLY NI TP
			C713	0CQ1031N419 0.01U 100V J POLY NI TP
			C716	0CK2710K515 270P 50V K B TS
			C717	0CE105CN638 1UF SHL,SD 100V M FM5 TP 5
			C718	181-288D MKT 100V 473JTR PHS26473
			C719	0CZZTAB001A SM-BP(P)/BP 10UF 50V 13*25 BK5
			C721-1	181-477W 473J 19.5*15.0*8.5*7.5 250V J
			C722	181-303W 0.2UF D 250V J PP NI FM20
			C723	181-482A 104J 18.0*13.0*7.0*7.5 250V J
			C724	0CN1040K949 0.1M 50V Z F TA52
			C725	0CK6810W515 680P 500V K B TS
			C726	181-305Y MPP 250 204J S=10.0
			C727	0CN1040K949 0.1M 50V Z F TA52
			C728	0CQ5621N419 5600P 100V J POLY NI TP
			C729	181-305V 514J 26.0*18.0*11.0*15.0 250V
			C730	0CN1040K949 0.1M 50V Z F TA52
			C731	0CBZTBU004D 542J 29.0*20.5*9.5*20.0 2.5KV
			C732	0CQ1031N419 0.01U 100V J POLY NI TP
			C733	0CBZTBU003J 392J 20.0*12.5*7.5*10.0 800V J
			C737	0CK10102515 100PF 2KV K B TR
			C739	0CE226CK638 22UF SHL,SD 50V M FM5 TP 5
			C740	0CE227EL630 220UF KMG 63V M FM5 BULK
			C741	0CZZTFT002B ECQV1H154JZ3 154J 50V TP5.0 MA
			C742	0CZZTFT001R ECQB1H223JM3 223J 50V TP5.0 MA
			C743	0CK3310W515 330P 500V K B TS
			C744	0CE107CP630 100UF SHL 160V M FM5 BULK
			C745	0CK5610W515 560P 500V K B TS
			C746	0CK33101515 330P 1KV K B TS

DATE: 2002. 05. 13.				
*S	*AL	LOC. NO.	PART NO.	DESCRIPTION / SPECIFICATION
		C747	OCK3320W515	3300P 500V K B TS
		C748	181-288B	MKT 100V 104JTR PHS26104
		C749	OCE2256R638	2.2000UF SMS 250V M FM5 TP5
		C750	OCK1040K945	0.1UF 50V Z F TR
		C751	181-288N	MKT 100V 103JTR PHS86103
		C752	OQ4721N419	0.0047U 100V J POLY NI TP5
		C754	OCC4700W405	47PF 500V J SL TP
		C755	OCN1040K949	0.1M 50V Z F TA52
		C767	OCK10301510	0.01M 1KV K B S
		C771	OCK10301510	0.01M 1KV K B S
		C773	OCE107CH638	100UF SHL,SD 25V M FM5 TP 5
		C774	181-288B	MKT 100V 104JTR PHS26104
		C775	OCK2210K515	220P 50V K B TS
		C781	OCK1030K945	0.01UF 50V Z F TR
		C801	OCK1040K945	0.1UF 50V Z F TR
		C802	OCE106CK638	10UF SHL,SD 50V M FM5 TP 5
		C805	OCE106CK638	10UF SHL,SD 50V M FM5 TP 5
		C810	OCE106CK638	10UF SHL,SD 50V M FM5 TP 5
		C821	OCK1040K945	0.1UF 50V Z F TR
		C822	OCN1040K949	0.1M 50V Z F TA52
		C830	OCK10101515	100PF 1KV K B TR
		C901	OCBZTBU002B	BULK PCX2 335 474K
		C902	OCBZTBU002A	BULK PCX2 335 224K
		C903	OCKZTTA003A	SC E 222M 10.0FF7 250V TP7.5 S
		C904	OCKZTTA003A	SC E 222M 10.0FF7 250V TP7.5 S
		C905	OCE476EK638	47UF KMG 50V M FM5 TP 5
		C906	OCK1520K515	1500P 50V K B TS
		C908	181-124R	220UF SMG(25.4*40) 400V M VNSN
		C909	181-304T	273J 19.5*14.0*8.5*10.0 400V J
		C910	OCK33101515	330P 1KV K B TS
		C911	OQ4721N419	1000P 100V J POLY NI TP
		C912	OCKZTTA003D	SC SAMWHA 250V 1000F M TAPING
		C913	OCKZTTA003D	SC SAMWHA 250V 1000F M TAPING
		C941	OCE108EF630	1000UF KMG 16V M FM5 BULK
		C941	OCE108EF618	1000UF KMG 16V M FL TP 5 (Only
		C942	OCE107CF638	100UF SHL,SD 16V M FM5 TP 5
		C943	OCK3310W515	330P 500V K B TS
		C944	OCKZTBU003C	SC E 472M 14.0BW7 250V BK7.5 S
		C944	OCKZTBU003C	SC E 472M 14.0BW7 250V BK7.5 S
		C945	OCKZTBU003C	SC E 472M 14.0BW7 250V BK7.5 S
		C945	OCKZTBU003C	SC E 472M 14.0BW7 250V BK7.5 S
		C951	OCE228CH630	2200U SHL 25V M FM5
		C951	OCE228CH618	2200U SHL 25V M FL TP5 (Only
		C952	OCE227CH638	220UF SHL,SD 25V M FM5 TP 5
		C953	OCE107CF638	100UF SHL,SD 16V M FM5 TP 5
		C954	OCE108ED618	1000UF KMG 10V M FL TP 5
		C971	OCE476EN618	47UF KMG 100V M FL TP 5
		C999	OCE227EL630	220UF KMG 63V M FM5 BULK
DIODEs				
		D201	0DLLT0089AA	LITEON LTL-1BEDJ-0C2 TP GREEN/
		D301	0DS141489AB	1N4148 TP GRANDE DO-34 500MW 1
		D302	0DS141489AB	1N4148 TP GRANDE DO-34 500MW 1
		D303	0DS141489AB	1N4148 TP GRANDE DO-34 500MW 1
		D304	0DS141489AB	1N4148 TP GRANDE DO-34 500MW 1
		D305	0DS141489AB	1N4148 TP GRANDE DO-34 500MW 1
		D306	0DS141489AB	1N4148 TP GRANDE DO-34 500MW 1
		D307	0DS124409AA	1SS244 TP ROHM KOREA
		D308	0DS124409AA	1SS244 TP ROHM KOREA
		D309	0DS124409AA	1SS244 TP ROHM KOREA
		D310	0DS124409AA	1SS244 TP ROHM KOREA

DATE: 2002. 05. 13.				
*S	*AL	LOC. NO.	PART NO.	DESCRIPTION / SPECIFICATION
		D311	0DS124409AA	1SS244 TP ROHM KOREA
		D312	0DS124409AA	1SS244 TP ROHM KOREA
		D313	0DS124409AA	1SS244 TP ROHM KOREA
		D314	0DS124409AA	1SS244 TP ROHM KOREA
		D315	0DS124409AA	1SS244 TP ROHM KOREA
		D316	6210TCE003J	BAS2550T BO SUNG 2550MM AXIAL5
		D317	0DS141489AB	1N4148 TP GRANDE DO-34 500MW 1
		D401	0DS141489AB	1N4148 TP GRANDE DO-34 500MW 1
		D402	971-0054	TIN 50MM TAPING
		D501	0DS141489AB	1N4148 TP GRANDE DO-34 500MW 1
		D511	0DS141489AB	1N4148 TP GRANDE DO-34 500MW 1
		D512	0DS141489AB	1N4148 TP GRANDE DO-34 500MW 1
		D701	0DS141489AB	1N4148 TP GRANDE DO-34 500MW 1
		D702	0DS141489AB	1N4148 TP GRANDE DO-34 500MW 1
		D704	0DR150051AA	DMV1500M/F5 ST SGS-THOMSON TO2
		D705	0DR100009CA	RGP10G TP GULF SEMICONDUCTOR L
		D706	0DR359150AA	BY359F-1500 BK PHILIPS SOD10
		D709	971-0054	TIN 50MM TAPING
		D710	0DR320400AA	S3L20U-4004P15 BK SHINDENGEN N
		D711	0DS141489AB	1N4148 TP GRANDE DO-34 500MW 1
		D712	0DR100009CA	RGP10G TP GULF SEMICONDUCTOR L
		D714	0DS141489AB	1N4148 TP GRANDE DO-34 500MW 1
		D715	0DS141489AB	1N4148 TP GRANDE DO-34 500MW 1
		D716	0DR140059DA	1N4005TB52 TP LITEON DO41 600V
		D717	0DR140059DA	1N4005TB52 TP LITEON DO41 600V
		D718	0DR140059DA	1N4005TB52 TP LITEON DO41 600V
		D719	0DR100009DA	RGP10J TP GULF SEMICONDUCTOR L
		D721	0DR100009CA	RGP10G TP GULF SEMICONDUCTOR L
		D723	0DS141489AB	1N4148 TP GRANDE DO-34 500MW 1
		D724	0DR100009DA	RGP10J TP GULF SEMICONDUCTOR L
		D725	0DS141489AB	1N4148 TP GRANDE DO-34 500MW 1
		D730	971-0054	TIN 50MM TAPING
		D735	0DR140059DA	1N4005TB52 TP LITEON DO41 600V
		D741	0DS141489AB	1N4148 TP GRANDE DO-34 500MW 1
		D767	0DR100009DA	RGP10J TP GULF SEMICONDUCTOR L
		D768	971-0054	TIN 50MM TAPING
		D801	0DS141489AB	1N4148 TP GRANDE DO-34 500MW 1
		D802	0DS141489AB	1N4148 TP GRANDE DO-34 500MW 1
		D821	0DS141489AB	1N4148 TP GRANDE DO-34 500MW 1
		D900	0DD406000AB	RBV406M FL-B BK SANKEN 600V 4
		D902	0DR153979AA	1N5397GP TP G.I DO201AD 600V 1
		D903	0DR100009CA	RGP10G TP GULF SEMICONDUCTOR L
		D905	0DD400709CB	UF4007 TP G.I DO204AL 1000V 1
		D906	0DS141489AB	1N4148 TP GRANDE DO-34 500MW 1
		D908	0DS141489AB	1N4148 TP GRANDE DO-34 500MW 1
		D941	0DD150009CB	RGP15D TP G.I DO204AC 200V 1.
		D942	0DRGS00089A	SB1H100 GENERAL SEMICONDUCTOR
		D951	0DRGS00110A	UF5403L-5700 GENERAL SEMICONDU
		D952	0DS141489AB	1N4148 TP GRANDE DO-34 500MW 1
		D961	0DRGS00090A	31GF6L-5701 GENERAL SEMICONDU
		D962	0DRGS00090A	31GF6L-5701 GENERAL SEMICONDU
		D971	0DR100009DA	RGP10J TP GULF SEMICONDUCTOR L
		ZD201	0DZ560009AG	GDZJ5.6B TP GRANDE DO-34 500MW
		ZD202	0DZ560009AG	GDZJ5.6B TP GRANDE DO-34 500MW
		ZD203	0DZ560009AG	GDZJ5.6B TP GRANDE DO-34 500MW
		ZD301	0DZ560009AG	GDZJ5.6B TP GRANDE DO-34 500MW
		ZD302	0DZ560009AG	GDZJ5.6B TP GRANDE DO-34 500MW
		ZD401	0DZ560009AG	GDZJ5.6B TP GRANDE DO-34 500MW
		ZD404	0DZ560009AG	GDZJ5.6B TP GRANDE DO-34 500MW
		ZD405	0DZ560009AG	GDZJ5.6B TP GRANDE DO-34 500MW
		ZD406	0DZ560009AG	GDZJ5.6B TP GRANDE DO-34 500MW
		ZD407	0DZ560009AG	GDZJ5.6B TP GRANDE DO-34 500MW

DATE: 2002. 05. 13.				
*S	*AL	LOC. NO.	PART NO.	DESCRIPTION / SPECIFICATION
		ZD410	0DZ560009AG	GDZJ5.6B TP GRANDE DO-34 500MW
		ZD411	0DZ560009AG	GDZJ5.6B TP GRANDE DO-34 500MW
		ZD412	0DZ560009AG	GDZJ5.6B TP GRANDE DO-34 500MW
		ZD701	0DZ110009CF	GDZJ11B TP GRANDE DO34 0.5W 11
		ZD702	0DZ560009AG	GDZJ5.6B TP GRANDE DO-34 500MW
		ZD705	0DZ510009BE	GDZ5.1B TP GRANDE DO34 500MW 5
		ZD901	0DZ510009BE	GDZ5.1B TP GRANDE DO34 500MW 5
		ZD902	0DZ510009BE	GDZ5.1B TP GRANDE DO34 500MW 5
ICs				
		IC301	0IPRPMJ008A	MTV038N-15EG MYSON 16P DIP ST
		IC302	0IPRPNS003A	LM1269NA NATIONAL SEMICONDUCTO
		IC303	0IPRPNS009A	LM2469TA NATIONAL SEMICONDUCTO
		IC304	0IPRPNS005A	LM2480NA NATIONAL SEMICONDUCTO
		IC401	0IZZTSZ181A	SS 42PIN ST FB775G CA-113
		IC402	0ISG240860A	M24C08-BN6 8DIP BK 8K SERIAL I
		IC402	0ISG240860A	M24C08-BN6 8DIP BK 8K SERIAL I
		IC403	0IKE704200H	KIA7042AP TO-92 TP 4.2 VOLT.
		IC601	0IPH486600C	TDA4866J 9P ST VERTICAL OUTPUT
		IC701	0IPRPPH005A	TDA4841PS PHILIPS 32P,SDIP ST
		IC901	0IPMGSK005A	STR-G8656D(LF1140) SANKEN 5P B
COILs & COREs				
		L301	0LA0270K119	0.27UH K 2.3*3.4 TP
		L302	0LA0270K119	0.27UH K 2.3*3.4 TP
		L303	0LA0270K119	0.27UH K 2.3*3.4 TP
		L304	0LA1000K119	100UH K 2.3*3.4 TP
		L311	0LA0820K119	0.82UH K 2.3*3.4 TP
		L312	0LA0820K119	0.82UH K 2.3*3.4 TP
		L313	0LA0820K119	0.82UH K 2.3*3.4 TP
		L501	6210TCE003K	BAS3550T BO SUNG 3550MM AXIAL5
		L502	6210TCE003K	BAS3550T BO SUNG 3550MM AXIAL5
		L702	6140TBZ025C	DR14*20 150UH 0.12*25MM 51T H-
		L703	6140TYZ011C	- GET DR14*25,5.4UH,FB775G
		L705	6140TBZ026C	DR15*18-C9.8 100UH 0.1*30MM 40
		L901	6200TLS004B	SQE2424 15MH 0.55MM 70T CB775C
TRANSISTOR				
		Q501	0TR320209AA	KTC3202-Y(KTC1959) TP KEC TO92
		Q502	0TR127009AA	KTA1270-Y(KTA562TM) TP KEC TO9
		Q503	0TR319809AA	KTC3198-Y(KTC1815) TP KEC TO92
		Q510	0TR319809AA	KTC3198-Y(KTC1815) TP KEC TO92
		Q511	0TR320509AB	KTC3205-Y(KTC2236A) TP KEC TO9
		Q512	0TR127509AC	KTA1275-Y(KTA1013) TP KEC TO92
		Q701	0TR200009AB	KTC200-Y TP KEC TO92 NPN
		Q706	0TR558900BA	2SC5589(LG,W/M) BK TOSHIBA TO3
		Q707	0TR127009AA	KTA1270-Y(KTA562TM) TP KEC TO9
		Q708	0TR127009AA	KTA1270-Y(KTA562TM) TP KEC TO9
		Q709	0TR141300AB	KTD1413 BK KEC TO220I S NPN
		Q710	0TR440009CA	KSP44 TP SAMSUNG
		Q711	0TF630000CA	IRFS630A BK SAMSUNG 200V 6.5A
		Q712	0TF630000CA	IRFS630A BK SAMSUNG 200V 6.5A
		Q713	0TF630000CA	IRFS630A BK SAMSUNG 200V 6.5A
		Q714	0TR319809AA	KTC3198-Y(KTC1815) TP KEC TO92
		Q715	0TR319809AA	KTC3198-Y(KTC1815) TP KEC TO92
		Q716	0TR319809AA	KTC3198-Y(KTC1815) TP KEC TO92
		Q719	0TF630000CA	IRFS630A BK SAMSUNG 200V 6.5A
		Q720	0TR390409CA	2N3904 TP SAMSUNG TO92 NPN
		Q722	0TR319809AA	KTC3198-Y(KTC1815) TP KEC TO92

DATE: 2002. 05. 13.				
*S	*AL	LOC. NO.	PART NO.	DESCRIPTION / SPECIFICATION
			Q723	0TR127009AA KTA1270-Y(KTA562TM) TP KEC TO9
			Q799	0TR920009AB KSP92 TP SAMSUNG TO92 HIGH VOL
			Q821	0TRFC10003A FAIRCHILD KSD882Y-S ST TO126 4
			Q903	0TRFC10003A FAIRCHILD KSD882Y-S ST TO126 4
			Q941	0TR319809AA KTC3198-Y(KTC1815) TP KEC TO92
			Q942	0TR928009AB KSA928A-Y TP SAMSUNG TO92L PNP
			Q951	0TR319809AA KTC3198-Y(KTC1815) TP KEC TO92
			Q952	0TR928009AB KSA928A-Y TP SAMSUNG TO92L PNP
			Q953	0TR319809AA KTC3198-Y(KTC1815) TP KEC TO92
RESISTORs				
			R201	0RD1001Q609 1K 1/4W(3 5% TA52
			R202	0RD0912Q609 91 OHM 1/4 W (3.4) 5% TA52
			R203	0RD2200Q609 220 1/4W(3 5% TA52
			R204	0RD4300Q609 430 OHM 1/4 W(3.4) 5.00% TA52
			R205	0RD1001Q609 1K 1/4W(3 5% TA52
			R206	0RD0912Q609 91 OHM 1/4 W (3.4) 5% TA52
			R207	0RD4300Q609 430 OHM 1/4 W(3.4) 5.00% TA52
			R208	0RD2200Q609 220 1/4W(3 5% TA52
			R209	0RD9100Q609 910 1/4W(3 5% TA52
			R210	0RD2200Q609 220 1/4W(3 5% TA52
			R211	0RD2200Q609 220 1/4W(3 5% TA52
			R301	0RD0752Q609 75 1/4W(3 5% TA52
			R302	0RD0752Q609 75 1/4W(3 5% TA52
			R303	0RD0752Q609 75 1/4W(3 5% TA52
			R304	0RD3301Q609 330K 1/4W(3 5% TA52
			R305	0RD5601Q609 560K 1/4W(3 5% TA52
			R306	0RD5601Q609 560K 1/4W(3 5% TA52
			R307	0RD1004Q609 1M OHM 1/4 W (3.4) 5% TA52
			R310	0RD1001Q609 1K 1/4W(3 5% TA52
			R312	0RD1001Q609 1K 1/4W(3 5% TA52
			R314	0RD1000Q609 100 1/4W(3 5% TA52
			R315	0RD1000Q609 100 1/4W(3 5% TA52
			R316	0RD1000Q609 100 1/4W(3 5% TA52
			R317	0RD1000Q609 100 1/4W(3 5% TA52
			R318	0RD1000Q609 100 1/4W(3 5% TA52
			R319	0RD4701Q609 4.70K 1/4W(3 5% TA52
			R320	0RD2001Q609 2K 1/4W(3 5% TA52
			R321	0RD2200Q609 220 1/4W(3 5% TA52
			R322	0RD2200Q609 220 1/4W(3 5% TA52
			R323	0RD2200Q609 220 1/4W(3 5% TA52
			R324	0RD2200Q609 220 1/4W(3 5% TA52
			R327	0RD1001Q609 1K 1/4W(3 5% TA52
			R328	0RD1001Q609 1K 1/4W(3 5% TA52
			R329	0RD1001Q609 1K 1/4W(3 5% TA52
			R330	0RD1000Q609 100 1/4W(3 5% TA52
			R331	0RD1000Q609 100 1/4W(3 5% TA52
			R332	0RD1000Q609 100 1/4W(3 5% TA52
			R333	0RD1000Q609 100 1/4W(3 5% TA52
			R334	0RD3303Q609 330K 1/4W(3 5% TA52
			R335	0RD3303Q609 330K 1/4W(3 5% TA52
			R336	0RD3303Q609 330K 1/4W(3 5% TA52
			R337	0RD1000Q609 100 1/4W(3 5% TA52
			R340	0RN1002F409 10K 1/6W 1 TA52
			R341	0RD0332A609 33 OHM 1/2 W (7.0) 5% TA52
			R342	0RD0332A609 33 OHM 1/2 W (7.0) 5% TA52
			R343	0RD0332A609 33 OHM 1/2 W (7.0) 5% TA52
			R344	0RD0332Q609 33 1/4W(3 5% TA52
			R345	0RD0332Q609 33 1/4W(3 5% TA52
			R346	0RD0332Q609 33 1/4W(3 5% TA52
			R347	0RD1200Q609 120 1/4W(3 5% TA52

DATE: 2002. 05. 13.				
*S	*AL	LOC. NO.	PART NO.	DESCRIPTION / SPECIFICATION
		R388	ORD1000Q609	100 1/4W(3 5% TA52
		R389	ORD1000Q609	100 1/4W(3 5% TA52
		R390	ORD1000Q609	100 1/4W(3 5% TA52
		R401	ORD1000Q609	100 1/4W(3 5% TA52
		R402	ORD1002Q609	10K 1/4W(3 5% TA52
		R403	ORD2200Q609	220 1/4W(3 5% TA52
		R404	ORD1000Q609	100 1/4W(3 5% TA52
		R405	ORD1000Q609	100 1/4W(3 5% TA52
		R406	ORD2001Q609	2K 1/4W(3 5% TA52
		R407	ORD2001Q609	2K 1/4W(3 5% TA52
		R408	ORD3302Q609	33K 1/4W(3 5% TA52
		R409	ORD1300Q609	130 1/4W(3 5% TA52
		R410	ORD1300Q609	130 1/4W(3 5% TA52
		R412	ORD2001Q609	2K 1/4W(3 5% TA52
		R413	ORD1001Q609	1K 1/4W(3 5% TA52
		R414	ORD1001Q609	1K 1/4W(3 5% TA52
		R415	ORD1001Q609	1K 1/4W(3 5% TA52
		R416	ORD1801Q609	1.80K 1/4W(3 5% TA52
		R417	ORD1001Q609	1K 1/4W(3 5% TA52
△		R418	ORD3901Q609	3.90K 1/4W(3 5% TA52
		R419	ORD1002Q609	10K 1/4W(3 5% TA52
		R420	ORD5101Q609	5.10K 1/4W(3 5% TA52
		R421	ORD1002Q609	10K 1/4W(3 5% TA52
△		R422	ORD1001Q609	1K 1/4W(3 5% TA52
		R423	ORD5600Q609	560 1/4W(3 5% TA52
		R430	ORD1000Q609	100 1/4W(3 5% TA52
		R431	ORD1000Q609	100 1/4W(3 5% TA52
		R432	ORD1000Q609	100 1/4W(3 5% TA52
		R433	ORD2001Q609	2K 1/4W(3 5% TA52
		R434	ORD2001Q609	2K 1/4W(3 5% TA52
		R446	ORD1002Q609	10K 1/4W(3 5% TA52
		R501	ORD0102A609	10 OHM 1/2 W (7.0) 5% TA52
		R508	ORD4702Q609	47K 1/4W(3 5% TA52
		R509	ORD1502Q609	15K 1/4W(3 5% TA52
		R510	ORD4702Q609	47K 1/4W(3 5% TA52
		R511	ORD3902Q609	39K 1/4W(3 5% TA52
		R512	ORD5601Q609	5.60K 1/4W(3 5% TA52
		R513	ORD0242Q609	24 1/4W(3 5% TA52
		R514	ORD0101A609	1 OHM 1/2 W (7.0) 5% TA52
		R515	ORD1502Q609	15K 1/4W(3 5% TA52
		R597	ORD3902Q609	39K 1/4W(3 5% TA52
		R598	ORD5601Q609	5.60K 1/4W(3 5% TA52
		R599	ORD0202Q609	20 1/4W(3 5% TA52
		R601	ORD1001Q609	1K 1/4W(3 5% TA52
		R602	ORD1001Q609	1K 1/4W(3 5% TA52
		R603	ORN0390H609	0.39 1/2W 5 TA52
		R604	ORD0101A609	1 OHM 1/2 W (7.0) 5% TA52
		R605	ORD0102A609	10 OHM 1/2 W (7.0) 5% TA52
		R606	ORD1000A609	100 OHM 1/2 W (7.0) 5% TA52
		R607	ORN6201F409	6.20K 1/6W 1% TA52
		R608	ORD5100A609	510 OHM 1/2 W(7.0) 5.00% TA52
		R610	ORD1101Q609	1.1K OHM 1/4 W (3.4) 5% TA52
		R612	ORN5601F409	5.60K 1/6W 1% TA52
		R613	ORD1801Q609	1.80K 1/4W(3 5% TA52
		R700	ORX0221K607	2.2 OHM 2 W 5% TA62
		R701	ORD1500A609	150 OHM 1/2 W (7.0) 5% TA52
		R702	ORD5601Q609	5.60K 1/4W(3 5% TA52
△		R704	ORD3601Q609	3.60K 1/4W(3 5% TA52
		R705	ORD1602Q609	16K 1/4W(3 5% TA52
		R706	ORN2701F409	2.70K 1/6W 1% TA52
		R707	ORN3301F409	3.30K 1/6W 1% TA52
		R708	ORN1001F409	1K 1/6W 1% TA52

DATE: 2002. 05. 13.				
*S	*AL	LOC. NO.	PART NO.	DESCRIPTION / SPECIFICATION
		R709	ORD2202Q609	22K 1/4W(3 5% TA52
		R710	ORD1000Q609	100 1/4W(3 5% TA52
		R711	ORD1000Q609	100 1/4W(3 5% TA52
		R712	ORD1001Q609	1K 1/4W(3 5% TA52
		R713	ORD3300Q609	330 1/4W(3 5% TA52
△		R714	ORN1501F409	1.5K 1/6W 1 TA52
△		R714-1	ORN3001F409	3K 1/6W 1% TA52
△		R714-2	ORN6200F409	620 1/6W 1% TA52
△		R715	ORD2702Q509	27K OHM 1/4 W(3.4) 2% TA52
		R716	ORD7502Q609	75K 1/4W(3 5% TA52
		R717	ORD7501Q609	7.50K 1/4W(3 5% TA52
		R718	971-0054	TIN 50MM TAPING
		R719	ORD4701Q609	4.70K 1/4W(3 5% TA52
		R720	ORC1205Q609	12M OHM 1/4 W(3.4) 5% TA52
		R721	ORD1001Q609	1K 1/4W(3 5% TA52
		R723	ORD1001Q609	1K 1/4W(3 5% TA52
		R724	ORD1001Q609	1K 1/4W(3 5% TA52
		R725	ORD1001Q609	1K 1/4W(3 5% TA52
		R726	ORD5102A609	51K OHM 1/4 W (7.0) 5% TA52
		R727	ORD1001Q609	1K 1/4W(3 5% TA52
		R728	ORX0562K665	56 OHM 2 W 5.00% SF
		R728	ORX0562K607	56 OHM 2 W 5% TA62 (Only JAPAN
		R729	ORD3000A609	300 OHM 1/2 W (7.0) 5% TA52
		R731	ORD1002Q609	10K 1/4W(3 5% TA52
		R732	ORD6802Q509	68K OHM 1/4 W (3.4) 2% TA52
		R733	ORD1002Q609	10K 1/4W(3 5% TA52
		R735	ORD1001Q609	1K 1/4W(3 5% TA52
		R736	ORX1501J609	1.5KOHM 1 W 5% TA52
		R737	ORN0560H609	0.56 1/2W 5 TA52
		R738	ORN0560H609	0.56 1/2W 5 TA52
		R740	ORD0271A609	2.7 OHM 1/2 W (7.0) 5% TA52
		R741	ORD1000Q609	100 1/4W(3 5% TA52
		R742	ORD4702Q609	47K 1/4W(3 5% TA52
		R743	ORD2201Q509	2.2K OHM 1/4 W (3.4) 2% TA52
		R744	ORD2200A609	220 OHM 1/2 W (7.0) 5% TA52
		R745	ORD4702Q609	47K 1/4W(3 5% TA52
		R746	ORD2201Q609	2.20K 1/4W(3 5% TA52
		R747	ORD3001Q609	3K 1/4W(3 5% TA52
		R748	ORD4702Q609	47K 1/4W(3 5% TA52
		R749	ORD2201Q609	2.20K 1/4W(3 5% TA52
		R750	ORD3001Q609	3K 1/4W(3 5% TA52
		R752	ORD2201Q609	2.20K 1/4W(3 5% TA52
		R753	ORD3001Q609	3K 1/4W(3 5% TA52
		R754	ORX4300K607	430 OHM 2 W 5% TA62
		R755	ORD0471Q609	4.70 1/4W(3 5% TA52
		R756	ORD2202A609	22K OHM 1/2 W (7.0) 5% TA52
		R757	ORD0222A609	22 OHM 1/2 W (7.0) 5% TA52
		R758	ORN1303F409	130K 1/6W 1% TA52
		R759	ORN1302F409	13K 1/6W 1% TA52
		R760	ORD5103Q609	510K 1/4W(3 5% TA52
		R761	ORD3001Q609	3K 1/4W(3 5% TA52
		R762	ORD3001Q609	3K 1/4W(3 5% TA52
		R763	ORD3001Q609	3K 1/4W(3 5% TA52
		R764	ORD7501Q609	7.50K 1/4W(3 5% TA52
		R766	ORD6200Q609	620 1/4W(3 5% TA52
		R768	ORD1004A609	1.0M OHM 1/2 W (7.0) 5% TA52
		R771	ORD1501Q609	1.50K 1/4W(3 5% TA52
		R772	ORD2702Q509	27K OHM 1/4 W(3.4) 2% TA52
		R773	ORD3302A609	33K OHM 1/2 W (7.0) 5% TA52
		R775	ORD4701Q609	4.70K 1/4W(3 5% TA52
		R779	ORD4701Q609	4.70K 1/4W(3 5% TA52
		R782	ORD3301A609	3.3K OHM 1/2 W(7.0) 5.00% TA52

DATE: 2002. 05. 13.				
*S	*AL	LOC. NO.	PART NO.	DESCRIPTION / SPECIFICATION
		R784	ORD1000Q609	100 1/4W(3 5% TA52
		R789	ORD6800Q609	680 1/4W(3 5% TA52
		R793	ORD4702Q609	47K 1/4W(3 5% TA52
		R797	ORD1501Q609	1.50K 1/4W(3 5% TA52
		R798	ORD2001Q609	2K 1/4W(3 5% TA52
		R799	ORD1502Q609	15K 1/4W(3 5% TA52
		R801	ORD1602Q609	16K 1/4W(3 5% TA52
		R802	ORD3302Q609	33K 1/4W(3 5% TA52
		R803	ORD2001Q609	2K 1/4W(3 5% TA52
		R805	ORD2001Q609	2K 1/4W(3 5% TA52
		R806	ORD4702Q609	47K 1/4W(3 5% TA52
		R808	ORD6802Q609	68K 1/4W(3 5% TA52
		R809	ORMZTWD001G	RWR SMART 1OHM 5 W 5% PD TYPE
		R813	ORD4302A609	43K OHM 1/2 W(7.0) 5.00% TA52
		R814	ORD1002Q609	10K 1/4W(3 5% TA52
△		R816	ORN3601F409	3.6K 1/6W 1 TA52
△		R818	ORN2202F409	22K 1/6W 1% TA52
		R819	ORD4702Q609	47K 1/4W(3 5% TA52
		R821	ORD3001Q609	3K 1/4W(3 5% TA52
		R822	ORX0122K665	12 OHM 2 W 5% SF
		R823	ORX0242K665	24 OHM 2 W 5% SF
		R823	ORX0242K607	24 OHM 2 W 5.00% TA62 (Only JA
		R824	ORX0332K665	33 OHM 2 W 5% SF
		R824	ORX0332K607	33 OHM 2 W 5% TA62 (Only JAPAN
		R831	ORD1002Q609	10K 1/4W(3 5% TA52
		R901	ORD4703A609	470K OHM 1/2 W (7.0) 5% TA52
		R903	ORD5600A609	560 OHM 1/2 W (7.0) 5% TA52
		R904	ORX1503K607	150K OHM 2 W 5% TA62
		R905	ORD2201Q609	2.20K 1/4W(3 5% TA52
		R906	ORD6200Q609	620 1/4W(3 5% TA52
		R908	ORN0220H609	0.22 1/2W 5% TA52
		R910	ORX4702J609	47K OHM 1 W 5% TA52
		R925	ORB0120K607	0.12 OHM 2 W 5% TA62
		R941	ORN0220H609	0.22 1/2W 5% TA52
		R944	ORD4700A609	470 OHM 1/2 W (7.0) 5% TA52
		R945	ORD4701Q609	4.70K 1/4W(3 5% TA52
		R951	ORN0910H609	0.91 1/2W 5 TA52
		R952	ORD4702A609	47K OHM 1/2 W (7.0) 5% TA52
		R953	ORX4700J609	470 OHM 1 W 5% TA52
		R954	ORD4701Q609	4.70K 1/4W(3 5% TA52
		R955	ORD4701Q609	4.70K 1/4W(3 5% TA52
		R956	ORD4702Q609	47K 1/4W(3 5% TA52
		R957	ORD0472A609	47 OHM 1/2 W (7.0) 5% TA52
		R960	ORD2200A609	220 OHM 1/2 W (7.0) 5% TA52
		R967	971-0054	TIN 50MM TAPING
OTHERs				
		J19	ORD1000Q609	100 1/4W(3 5% TA52
		J20	ORD1000Q609	100 1/4W(3 5% TA52
		J27	ORD0471Q609	4.70 1/4W(3 5% TA52
		J5	ORD0242Q609	24 1/4W(3 5% TA52
		J59	ORD1000Q609	100 1/4W(3 5% TA52
		J99	ORD8202Q609	82K 1/4W(3 5% TA52
		RL901	6920TBB005A	ALA2PF12 MATSUSHITA 250V 5A 12
		SC301	6620TBD003A	PCS701E PARK ELEC. 10PIN 14/36
		SC901	6620TKB002A	BAE EUN AC UNIVERSAL 3PIN BLAC
		SG301	6918TRT005A	SSG-102-A0,1KV SMART RADIAL TA
		SG302	6918TRT005A	SSG-102-A0,1KV SMART RADIAL TA
		SG303	6918TRT005A	SSG-102-A0,1KV SMART RADIAL TA
		SG304	6918TRT005A	SSG-102-A0,1KV SMART RADIAL TA
		SG305	6918TRT005A	SSG-102-A0,1KV SMART RADIAL TA

DATE: 2002. 05. 13.				
*S	*AL	LOC. NO.	PART NO.	DESCRIPTION / SPECIFICATION
			SG701	6918TRT005A
			SW201	140-058D
			SW202	140-058D
			SW203	140-058D
			SW204	140-058D
			SW205	140-058D
			SW206	140-058D
			SW207	140-058D
			T1	6631T11005D
△			T701	6174T11003E
			T702	6170TCZ013A
			T703	6170TCZ001D
			T901	6170TMZ132A
			TH901	6322TB4R51A
			TH902	6322TA080BA
			X401	6202TTB003B
				SSG-102-A0,1KV SMART RADIAL TA
				SKHV10911A LGEC NON 12 20 HORI
				SKHV10911A LGEC NON 12 20 HORI
				SKHV10911A LGEC NON 12 20 HORI
				SKHV10911A LGEC NON 12 20 HORI
				SKHV10911A LGEC NON 12 20 HORI
				SKHV10911A LGEC NON 12 20 HORI
				SKHV10911A LGEC NON 12 20 HORI
				SKHV10911A LGEC NON 12 20 HORI
				1P W-T 520MM UL 1015 AWG 22 CB
				"1054A,CB777G LG-PHILIPS 17""
				EI2218 26UH D/FOCUS,FB775G
				EI2218 4.0MH H-DRIVE,EB770G
				EER3541 150UH V-16PIN EB770G S
				J503P61D4R5Q270S JAHWA 4.5 oh
				SCK-084 THINKING 8 ohm 15% 264
				HC-49/U HARMONY RADIAL 12MHZ 3

PIN CONFIGURATION

TDA4866J Current Driven Vertical Deflection Booster

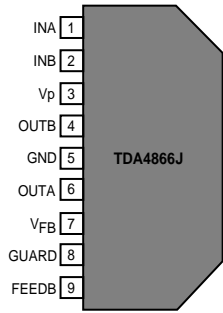
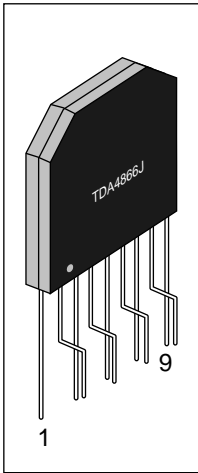

Pin Configuration

PIN	SYMBOL
1	INA
2	INB
3	V _P
4	OUTB
5	GND
6	OUTA
7	V _{FB}
8	GUARD
9	FEEDB

M24C08 Serial I²C BUS EEPROM

PSDIP8 (BN)
0.25mm Frame

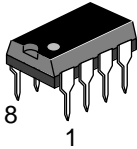

SO8 (MN)
150mil Width

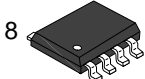

TSSOP8 (DW)
169mil Width

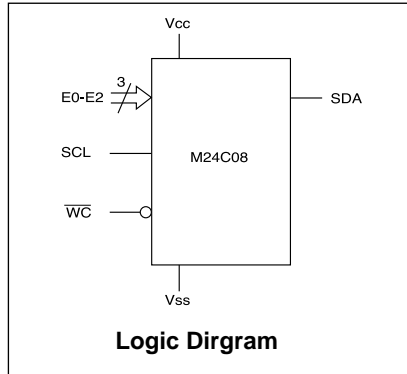
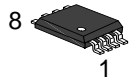

Logic Diagram

SYMBOL	DESCRIPTION
E0-E2	Chip Enable Input
SDA	Serial Data Address Input/Output
SCL	Serial Clock
WC	Write Control
V _{cc}	Supply Voltage
V _{ss}	Ground

LM2469 Monolithic Triple 9nS high Gain CRT Driver

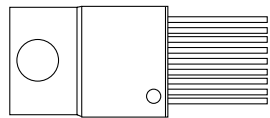

Connection Diagram

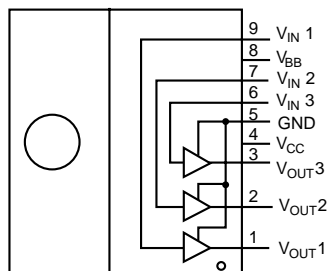

SCHEMATIC DIAGRAM

NOTICE

Since this is a basic schematic diagram, the value of components and some partial connections are subject to be changed for improvement without notice.

- IIC-SDA
- - - IIC-SCL
- · · DDC-SDA
- · · DDC-SCL

