



Website:<http://biz.LGservice.com>  
E-mail:<http://www.LGservice.com/techsup.html>

# COLOR MONITOR SERVICE MANUAL

CHASSIS NO. : CL-43

MODEL: FLATRON L1720B (L1720BL-AL\*\*R)

( ) \*\*Same model for Service

## CAUTION

BEFORE SERVICING THE UNIT,  
READ THE **SAFETY PRECAUTIONS** IN THIS MANUAL.

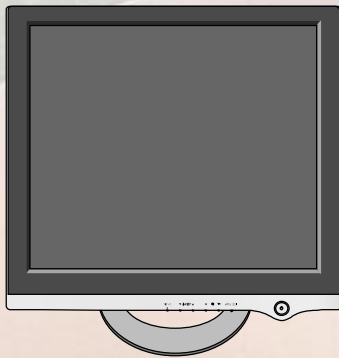

\*To apply the **Mstar Chip**.

# CONTENTS

SPECIFICATIONS .....	2	ADJUSTMENT .....	10
PRECAUTIONS .....	3	TROUBLESHOOTING GUIDE .....	11
TIMING CHART .....	4	PRINTED CIRCUIT BOARD.....	15
OPERATING INSTRUCTIONS .....	5	EXPLODED VIEW.....	17
WIRING DIAGRAM .....	6	REPLACEMENT PARTS LIST .....	19
BLOCK DIAGRAM .....	7	SCHEMATIC DIAGRAM.....	22
DESCRIPTION OF BLOCK DIAGRAM.....	8		

## SPECIFICATIONS

### 1. LCD CHARACTERISTICS

Type : TFT SXGA LCD  
 Size : 17 inch  
 Pixel Pitch : 0.264 (H) x 0.264 (V)  
 Color Depth : 16.2M colors  
 Electrical Interface : LVDS  
 Surface Treatment : Hard-coating(3H)  
 Operating Mode : Normally White  
 Backlight Unit : Top/Bottom edge side 4-CCFL  
 (Cold Cathode Fluorescent Lamp)

### 2. OPTICAL CHARACTERISTICS

2-1. Viewing Angle by Contrast Ratio  $\geq 10$   
 Left : -60° min., -70°(Typ) Right : +60° min., +70°(Typ)  
 Top : +50° min., +60°(Typ) Bottom : -45° min., -60°(Typ)

2-2. Luminance : 200(min), 250(Typ)

2-3. Contrast Ratio : 300(min), 400(Typ)

### 3. SIGNAL (Refer to the Timing Chart)

3-1. Sync Signal  
 • Type : Separate Sync,  
 SOG (Sync On Green)  
 Composite Sync

#### 3-2. Video Input Signal

1) Type : R, G, B Analog  
 2) Voltage Level : 0~0.71 V  
 a) Color 0, 0 : 0 Vp-p  
 b) Color 7, 0 : 0.467 Vp-p  
 c) Color 15, 0 : 0.714 Vp-p  
 3) Input Impedance : 75  $\Omega$

#### 3-3. Operating Frequency

Horizontal : 30 ~ 83kHz  
 Vertical : 56 ~ 75Hz

### 4. Max. Resolution

Analog : 1280 x 1024 / 75Hz

### 5. POWER SUPPLY

5-1. Power : AC 100-240V~, 50/60Hz , 1.0A

#### 5-2. Power Consumption

MODE	H/V SYNC	VIDEO	POWER CONSUMPTION	LED COLOR
POWER ON (NORMAL)	ON/ON	ACTIVE	less than 40 W	BLUE
STAND-BY	OFF/ON	OFF	less than 2 W	AMBER
SUSPEND	ON/OFF	OFF	less than 2 W	AMBER
DPMS OFF	OFF/OFF	OFF	less than 2 W	AMBER

### 6. ENVIRONMENT

6-1. Operating Temperature: 10°C~35°C (50°F~95°F)  
 (Ambient)

6-2. Relative Humidity : 10%~80%  
 (Non-condensing)

6-3. MTBF : 50,000 Hours(Min)

### 7. DIMENSIONS (with TILT/SWIVEL)

#### FullUp Position

Width : 394 mm (15.51")  
 Depth : 232 mm (9.13")  
 Height : 379 mm (14.92")



#### Folded Position

Width : 394mm (15.51")  
 Depth : 127mm (9.13")  
 Height : 412mm (14.92")



### 8. WEIGHT (with TILT/SWIVEL)

Net. Weight : 4.5 kg (9.92 lbs)  
 Gross Weight : 7.6 kg (16.76 lbs)

## PRECAUTION

### WARNING FOR THE SAFETY-RELATED COMPONENT.

- There are some special components used in LCD monitor that are important for safety. **These parts are marked  $\triangle$  on the schematic diagram and the replacement parts list.** It is essential that these critical parts should be replaced with the manufacturer's specified parts to prevent electric shock, fire or other hazard.
- Do not modify original design without obtaining written permission from manufacturer or you will void the original parts and labor guarantee.

### TAKE CARE DURING HANDLING THE LCD MODULE WITH BACKLIGHT UNIT.

- Must mount the module using mounting holes arranged in four corners.
- Do not press on the panel, edge of the frame strongly or electric shock as this will result in damage to the screen.
- Do not scratch or press on the panel with any sharp objects, such as pencil or pen as this may result in damage to the panel.
- Protect the module from the ESD as it may damage the electronic circuit (C-MOS).
- Make certain that treatment person's body are grounded through wrist band.
- Do not leave the module in high temperature and in areas of high humidity for a long time.
- The module not be exposed to the direct sunlight.
- Avoid contact with water as it may a short circuit within the module.
- If the surface of panel become dirty, please wipe it off with a softmaterial. (Cleaning with a dirty or rough cloth may damage the panel.)

### $\triangle$ CAUTION

Please use only a plastic screwdriver to protect yourself from shock hazard during service operation.

### $\triangle$ WARNING

#### BE CAREFUL ELECTRIC SHOCK!

- If you want to replace with the new backlight (CCFL) or inverter circuit, must disconnect the AC adapter because high voltage appears at inverter circuit about 650Vrms.
- Handle with care wires or connectors of the inverter circuit. If the wires are pressed cause short and may burn or take fire.



## TIMING CHART

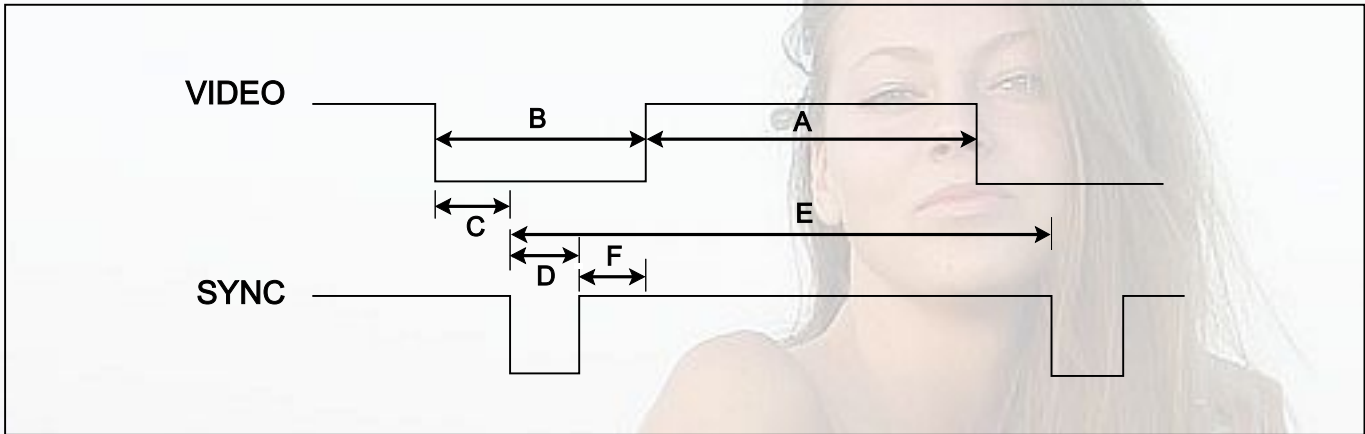

<< Dot Clock (MHz), Horizontal Frequency (kHz), Vertical Frequency (Hz), Horizontal etc... (μs), Vertical etc... (ms) >>

Mode	HV Sort	Sync Polarity	Dot Clock	Frequency	Total Period (E)	Video Active Time (A)	Front Porch (C)	Sync Duration (D)	Back Porch (F)	Resolution
1	H	+	25.175	31.469	800	640	16	96	48	640x350 70Hz
	V	-		70.8Hz	449	350	37	2	60	
2	H	-	28.321	31.468	900	720	18	108	54	720x400 70Hz
	V	+		70.09	449	400	12	2	35	
3	H	-	25.175	31.469	840	640	16	96	48	640x480 60Hz
	V	-		59.94	525	480	10	2	33	
4	H	-	31.5	37.5	840	640	16	64	120	640x480 75Hz
	V	-		75	500	480	1	3	16	
5	H	+	40.0	37.879	1056	800	40	128	88	800x600 60Hz
	V	+		60.317	628	600	1	4	23	
6	H	+	49.5	46.875	1056	800	16	80	160	800x600 75Hz
	V	+		75.0	625	600	1	3	21	
7	H	+/-	57.283	49.725	1152	832	32	64	224	832x624 75Hz
	V	+/-		74.55	667	624	1	3	39	
8	H	-	65.0	48.363	1344	1024	24	136	160	1024x768 60Hz
	V	-		60.0	806	768	3	6	29	
9	H	-	78.75	60.123	1312	1024	16	96	176	1024x768 75Hz
	V	-		75.029	800	768	1	3	28	
10	H	+/-	100.0	68.681	1456	1152	32	128	144	1152x870 75Hz
	V	+/-		75.062	915	870	3	3	39	
11	H	+/-	92.978	61.805	1504	1152	18	134	200	1152x900 65Hz
	V	+/-		65.96	937	900	2	4	31	
12	H	+	108.0	63.981	1688	1280	48	112	248	1280x1024 60Hz
	V	+		60.02	1066	1024	1	3	38	
13	H	+	135.0	79.976	1688	1280	16	144	248	1280x1024 75Hz
	V	+		75.035	1066	1024	1	3	38	

# OPERATING INSTRUCTIONS

## FRONT VIEW



See front control panel

## REAR VIEW



D-sub Connect

Power Connect

## Front Control Panel

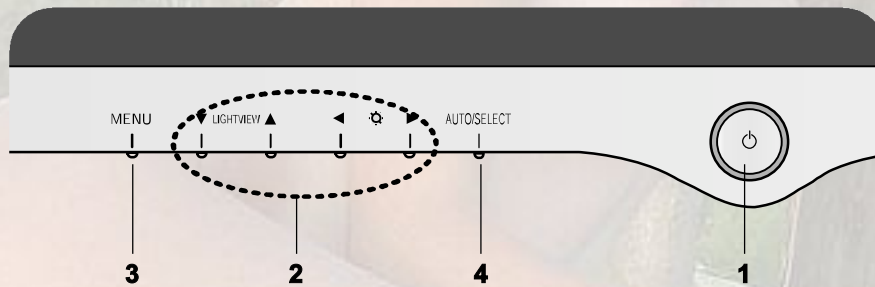

### 1. Power Button

Use this button to turn the display on or off.

#### <Power (DPMS) Indicator>

This Indicator lights up blue when the display operates normally. If the display is in DPM (Energy Saving) mode, this indicator color changes to amber.

### 2. ▲▼/◀▶ Button

Use these buttons to choose or adjust items in the On Screen Display.

#### ▼ Light View ▲

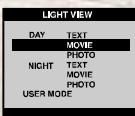

This function optimizes the brightness, contrast or color value to the surrounding conditions and settings and enables you to enjoy the most suitable picture by adjusting the surroundings (DAY/NIGHT/USER MODE).

- TEXT: For viewing letters
- MOVIE: For viewing movies
- PHOTO: For viewing pictures or the photographs
- USER MODE: This function memorizes the manual adjustment -Brightness, Contrast and Color value on the On Screen Display.

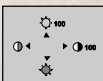

Bring up Contrast and Brightness adjustment.

: ◀☀▶ →▼▲◀▶→ MENU

### 3. Menu Button

Use this button to enter or exit the On Screen Display.

### 4. AUTO/SELECT Button

Use this button to enter a selection in the On Screen Display.



When adjusting your display settings, always press the **AUTO/SELECT** button before entering the On Screen Display(OSD). This will automatically adjust your display image to the ideal settings for the current screen resolution size (display mode).

The best display mode is **1024x768/60Hz**.

# WIRING DIAGRAM

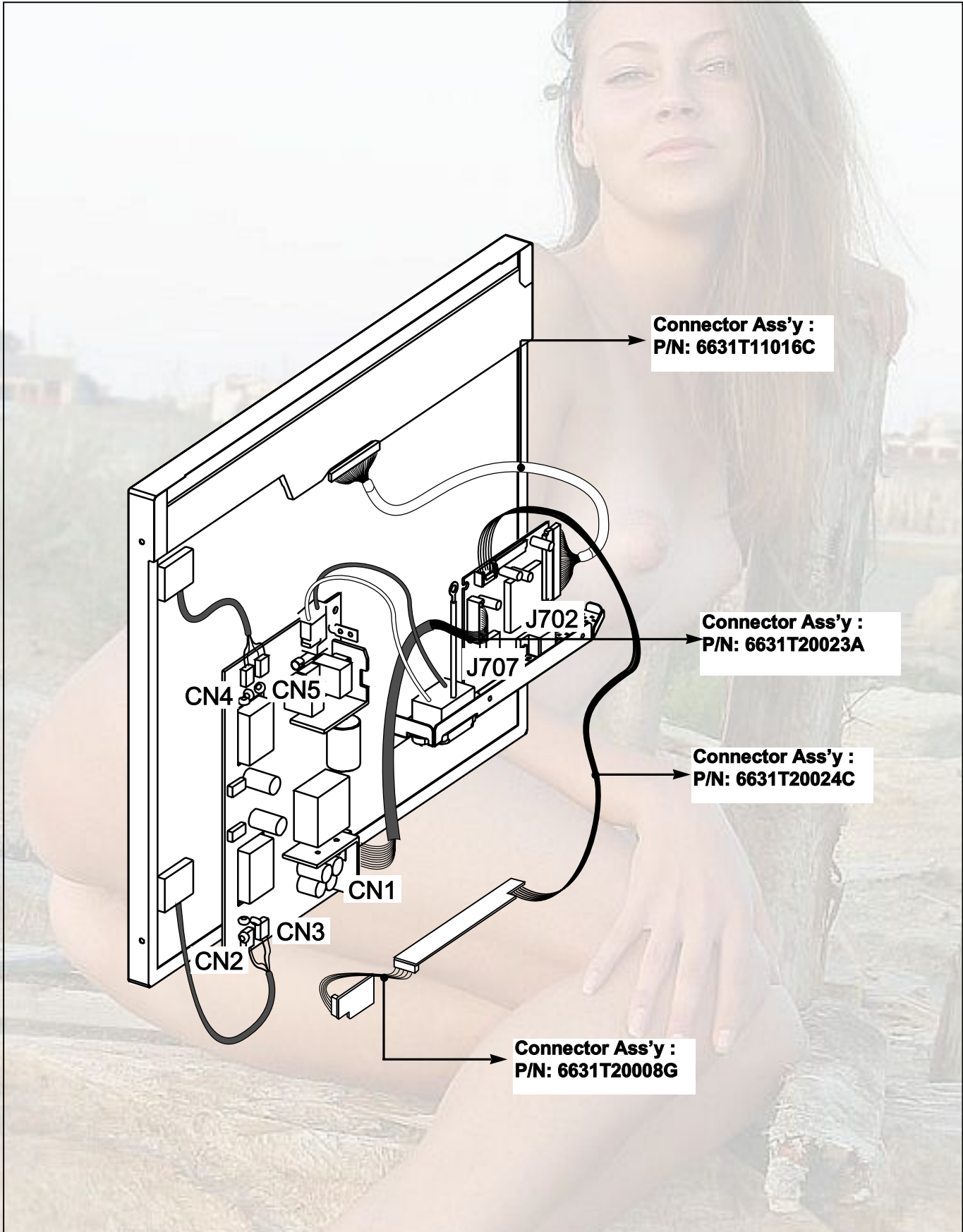



# BLOCK DIAGRAM

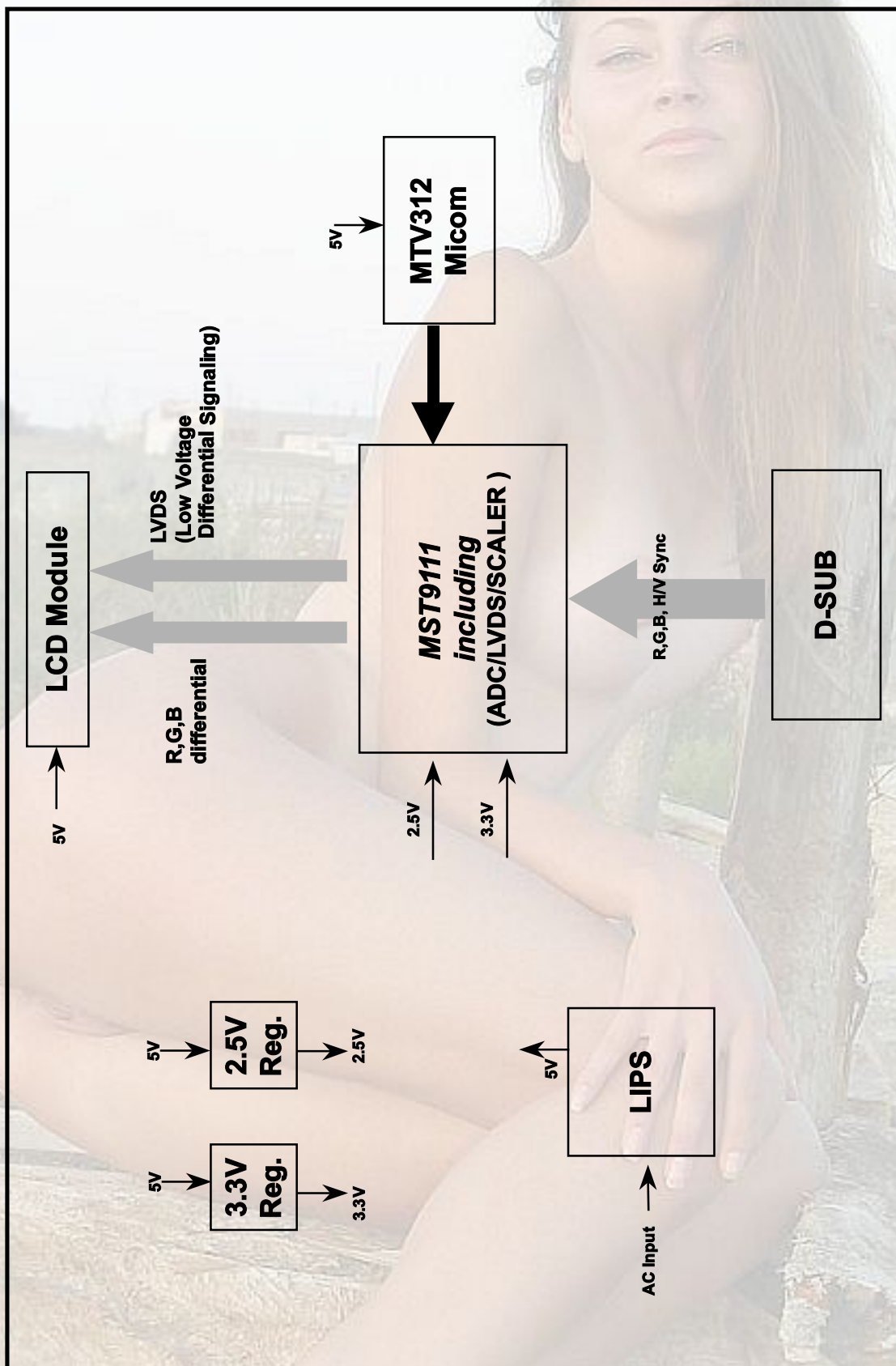

## DESCRIPTION OF BLOCK DIAGRAM

### 1. Video Controller Part & Display Data Transmitter Part.(MST9111)

This part amplifies the level of video signal for the digital conversion and converts from the analog video signal to the digital video signal using a pixel clock.

The pixel clock for each mode is generated by the PLL.

The range of the pixel clock is from 25MHz to 135MHz.

This part consists of the Scaler.

The Scaler gets the video signal converted analog to digital, interpolates input to 1280 x 1024 resolution signal and outputs 8-bit R, G, B signal to transmitter.

Especially pre-amp / ADC / Video controller/ Transmitter are merged to one chip "MST9111" by MSTAR.

This part transmit digital signal from the Scaler to the receiver of module.

### 2. Micom Part

This Part consists of EEPROM IC which stores control data, Reset IC and the Micom.

The Micom distinguishes polarity and frequency of the H/V Sync are supplied from signal cable.

The controlled data of each modes is stored in EEPROM.

### 3. Power Part

This part consists of the one 3.3V and one 2.5 regulators to convert power which is provided 5V in LIPS Board.

5V is provided for LCD Panel.

Also, 5V is converted 3.3V and 2.5V by regulator. Converted power is provided for IC in the main board.



## LIPS Board Block Diagram

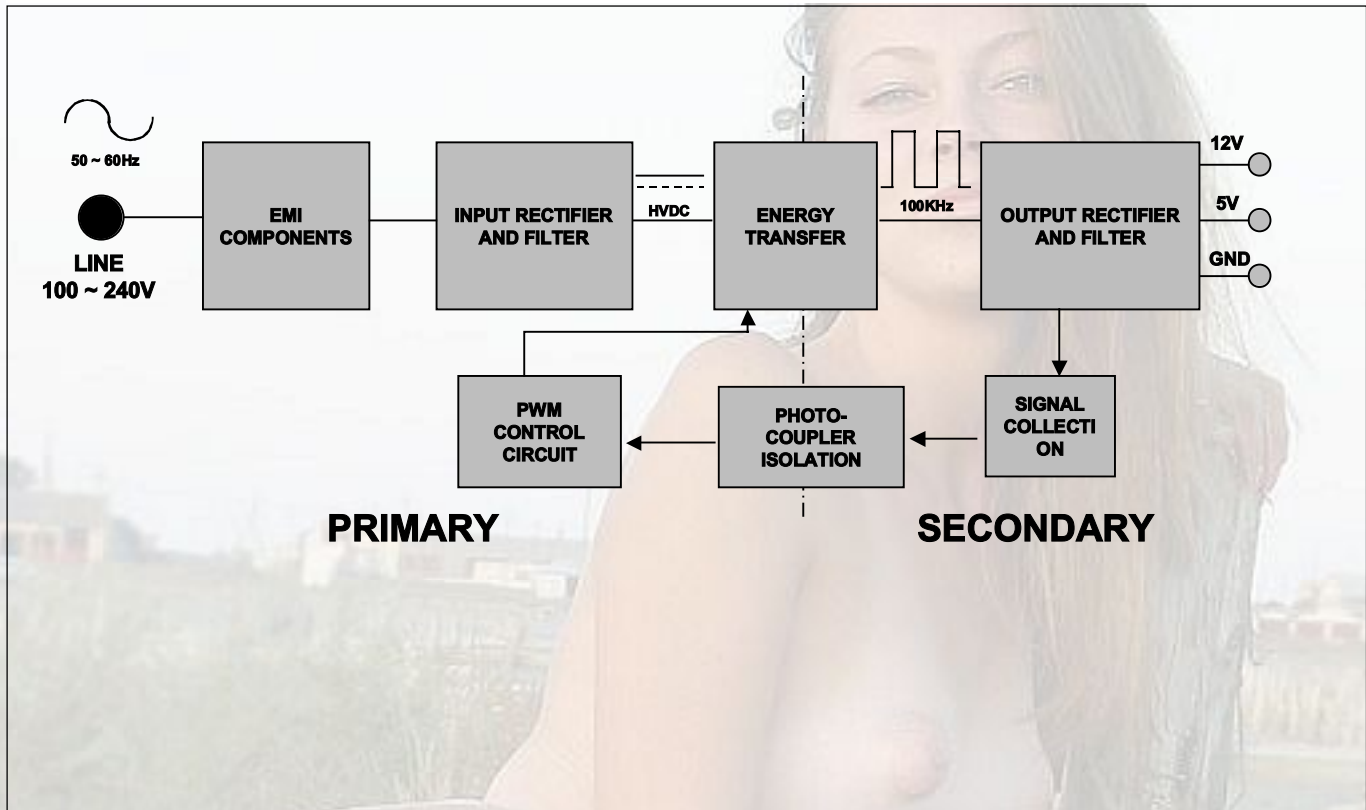

### Operation description\_LIPS

#### 1. EMI components.

This part contains of EMI components to comply with global marketing EMI standards like FCC, VCCI CISPR, the circuit included a line-filter, across line capacitor and of course the primary protection fuse.

#### 2. Input rectifier and filter.

This part function is for transfer the input AC voltage to a DC voltage through a bridge rectifier and a bulk capacitor.

#### 3. Energy Transfer.

This part function is transfer the primary energy to secondary through a power transformer.

#### 4. Output rectifier and filter.

This part function is to make a pulse width modulation control and to provide the driver signal to power switch, to adjust the duty cycle during different AC input and output loading condition to achieve the dc output stabilize, and also the over power protection is also monitor by this part.

#### 5. Photo-Coupler isolation.

This part function is to feed back the dc output changing status through a photo transistor to primary controller to achieve the stabilized dc output voltage.

#### 6. Signal collection.

This part function is to collect the any change from the dc output and feed back to the primary through photo transistor.

# ADJUSTMENT

All adjustment are thoroughly checked and corrected when the monitor leaves the factory, but sometimes several minor adjustment may be required.

Adjustment should be following procedure and after warming up for a minimum of 10 minutes.

- Alignment appliances and tools.
  - IBM compatible PC
  - Programmable Signal Generator. (eg. VG-819 made by Astrodesign Co.)
  - E(E)PROM with each mode data saved.

## 1. Adjustment process for LCD MONITOR

- 1) Display half window pattern(or mixed white and black pattern)at Mode 8 (1024x768@60Hz).
- 2) Press the POWER and MENU key at the same time to light monitor, then go to adjustment mode.
- 3) Press the MENU s/w, next press UP button, you will see adjustment OSD menu.
- 4) Press the AUTO/SELECT to select the adjustment item first(use the same button to exit)next do the operation to the relative item.Ex) 17HYDIS is used at 17AU, press right button to select. Press the AUTO/SELECT then selected proper Module.
- 5) Press down button to move the place of ADC CAL. Press the AUTO/SELECT to select, right button is pressed for adjustment.
- 6) When adjustment is finished, press the POWER key twice to light monitor again. The dajustment ends.

## 2. Adjustment for EDID

- 1) Use this procedure only when there is some problm on EDID data.
- 2) Connect the D-sub cable.
- 3) Select EDID → Write EDID[A0] command and Enter.

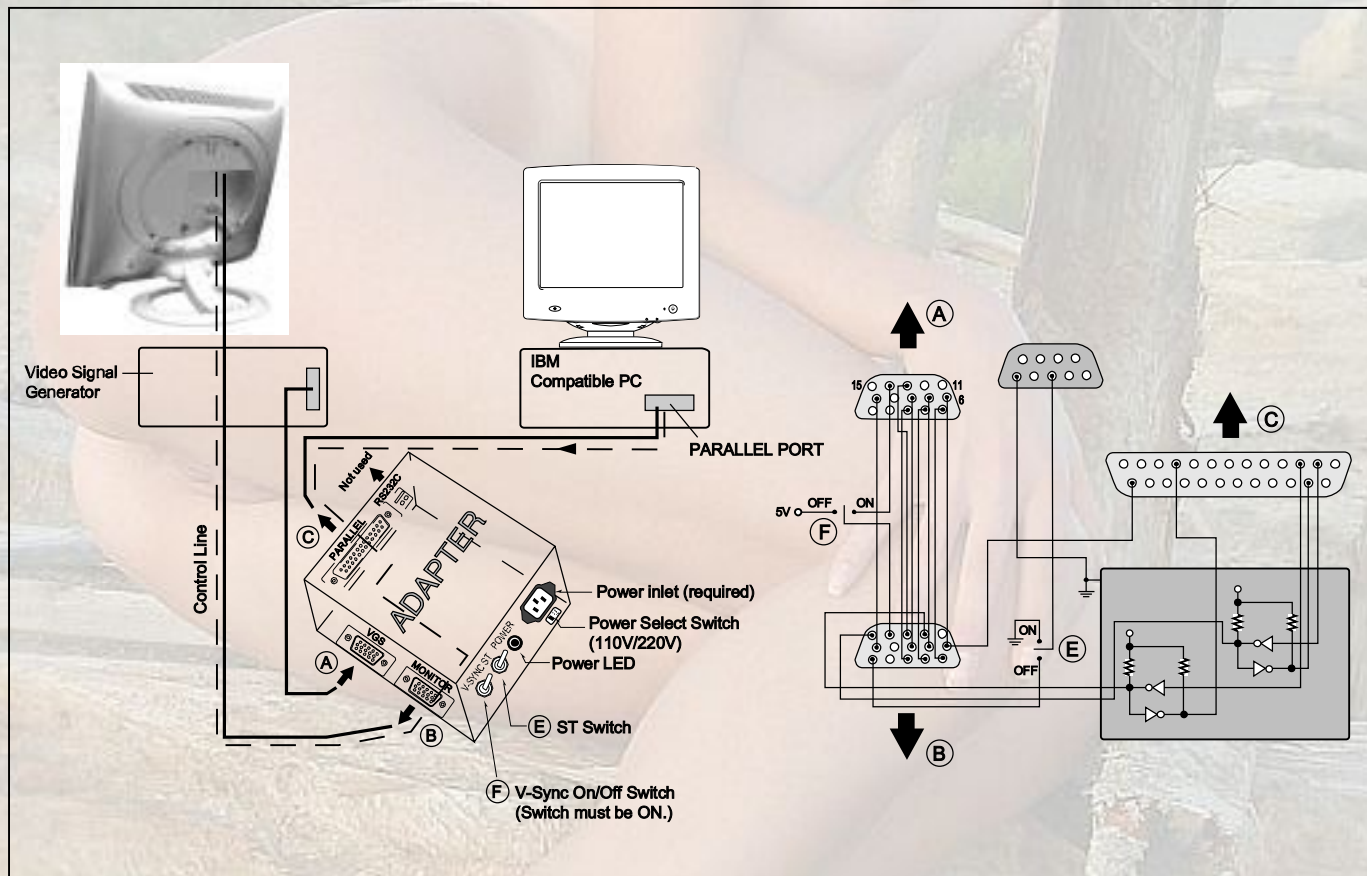
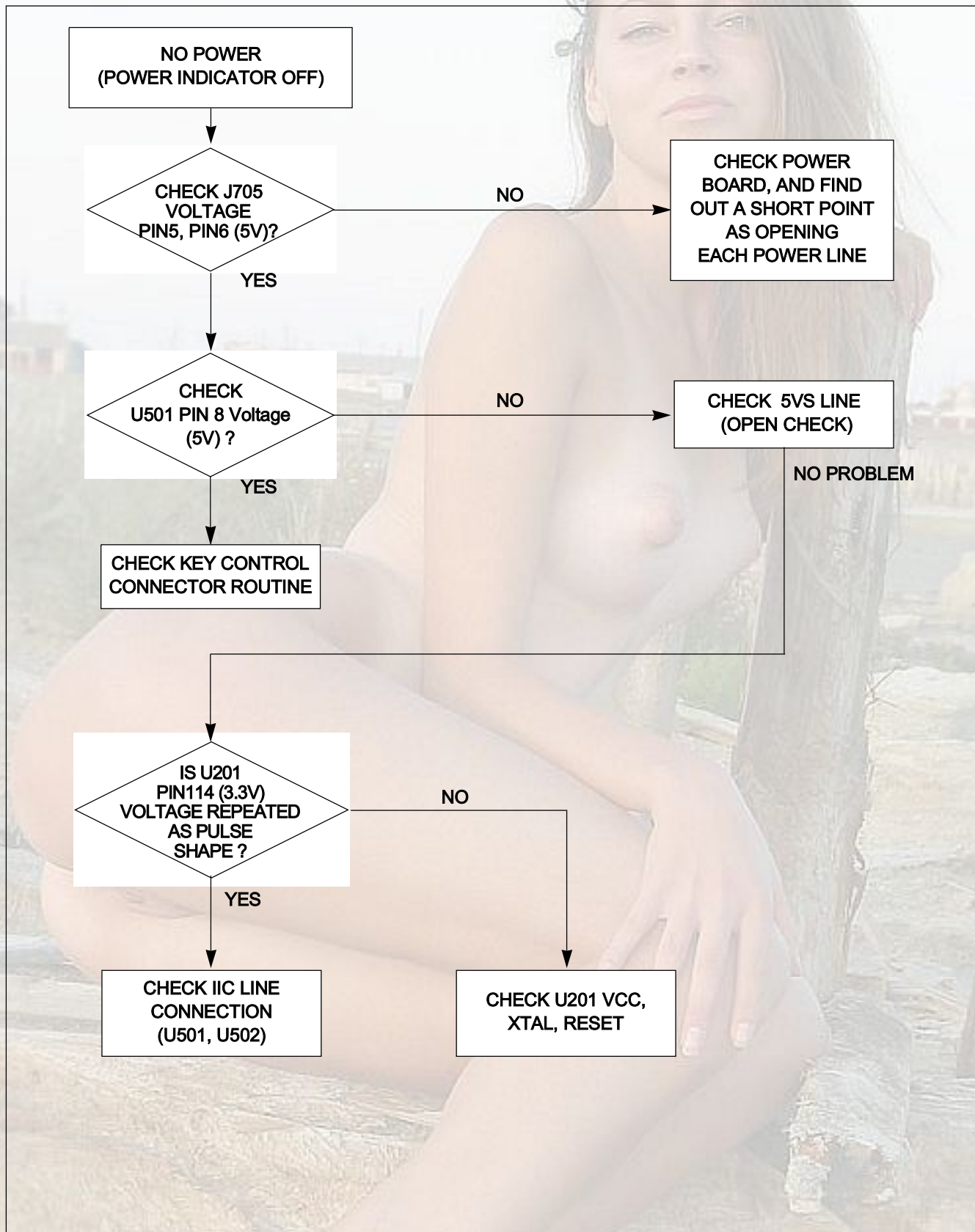

Figure 1. Cable Connection

# TROUBLESHOOTING GUIDE

## 1. NO POWER





## 2. NO RASTER (OSD IS NOT DISPLAYED) – LIPS

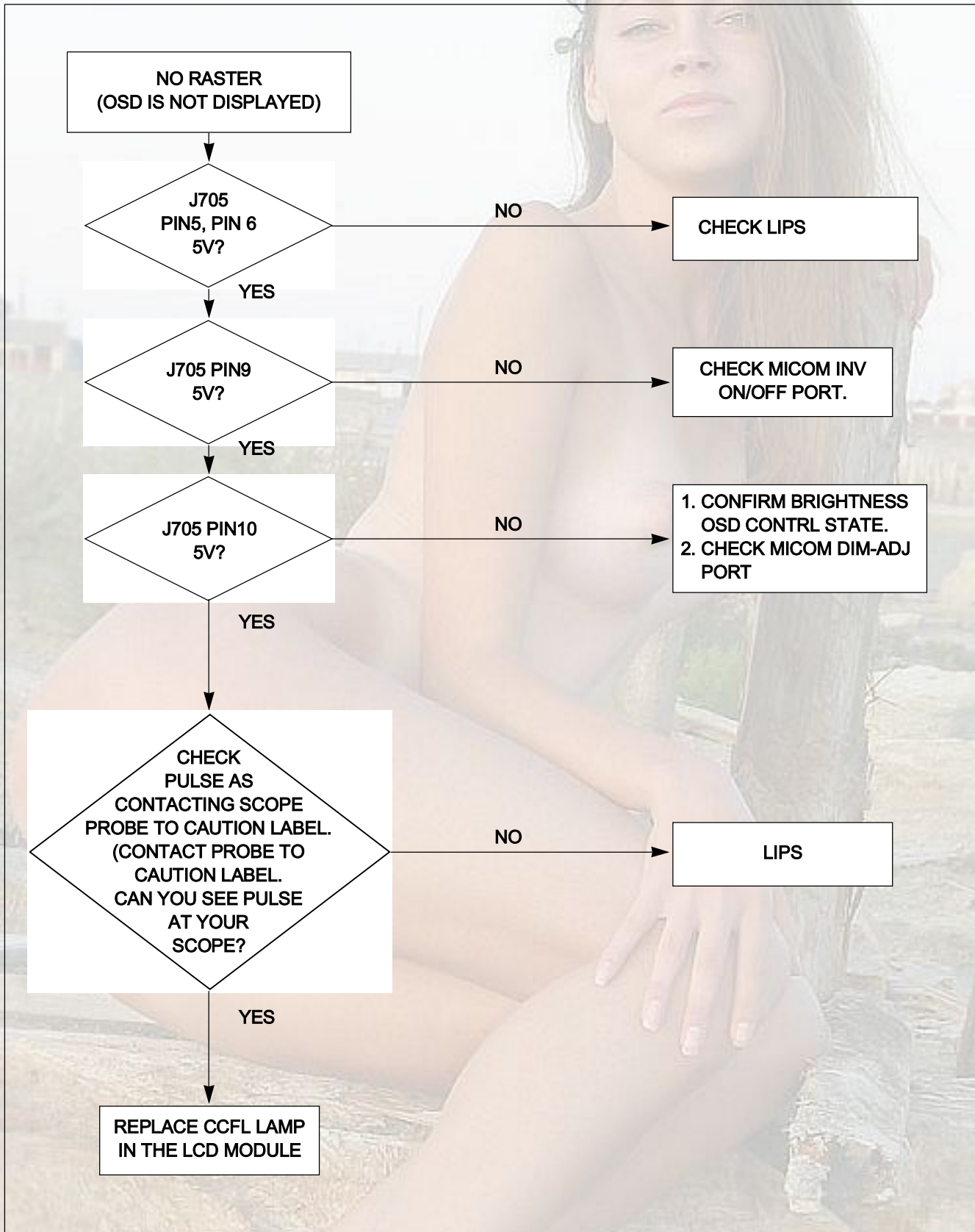

### 3. NO RASTER (OSD IS NOT DISPLAYED) – MST9111

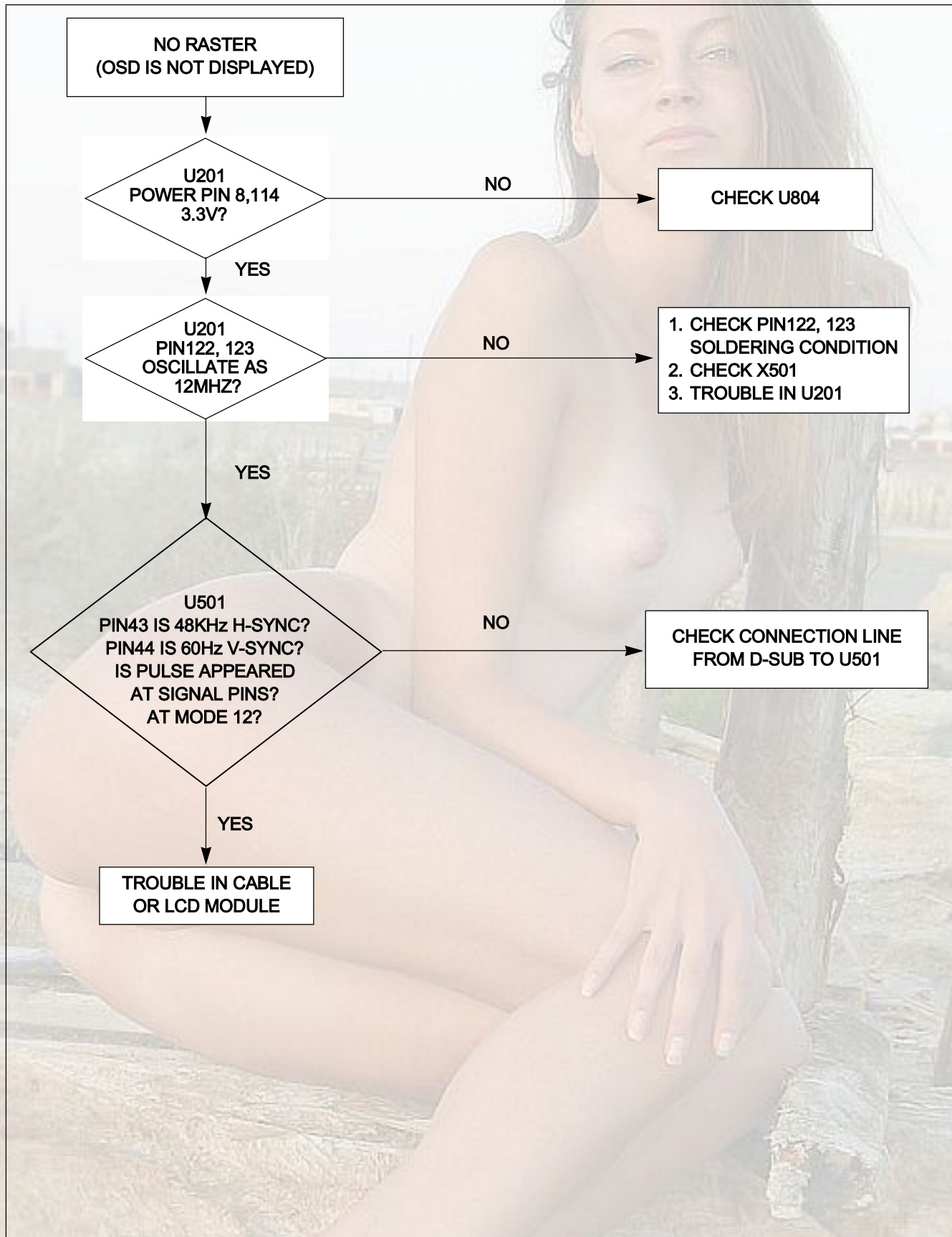

#### 4. TROUBLE IN DPM

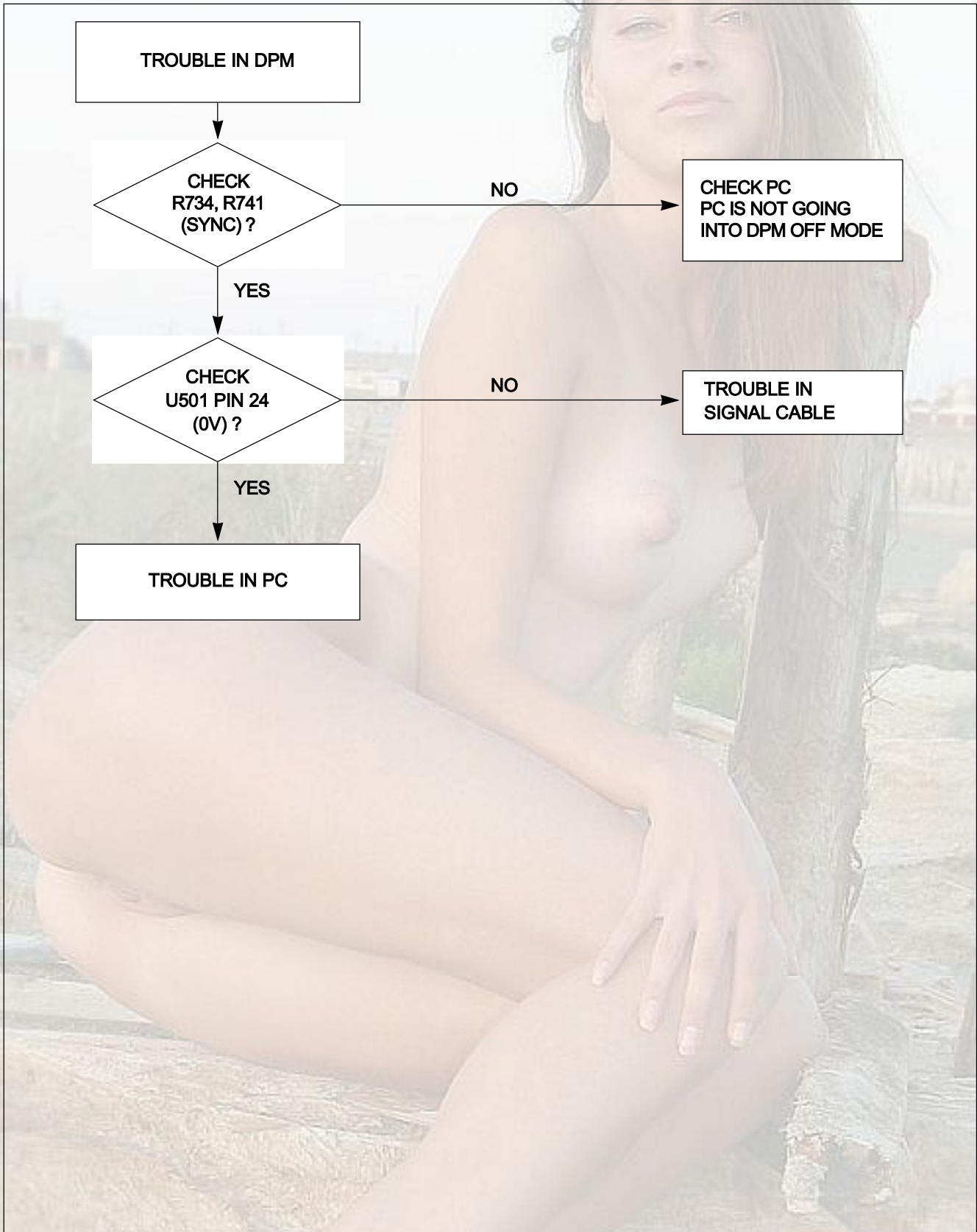



# PRINTED CIRCUIT BOARD

## 1. MAIN BOARD (Component Side)

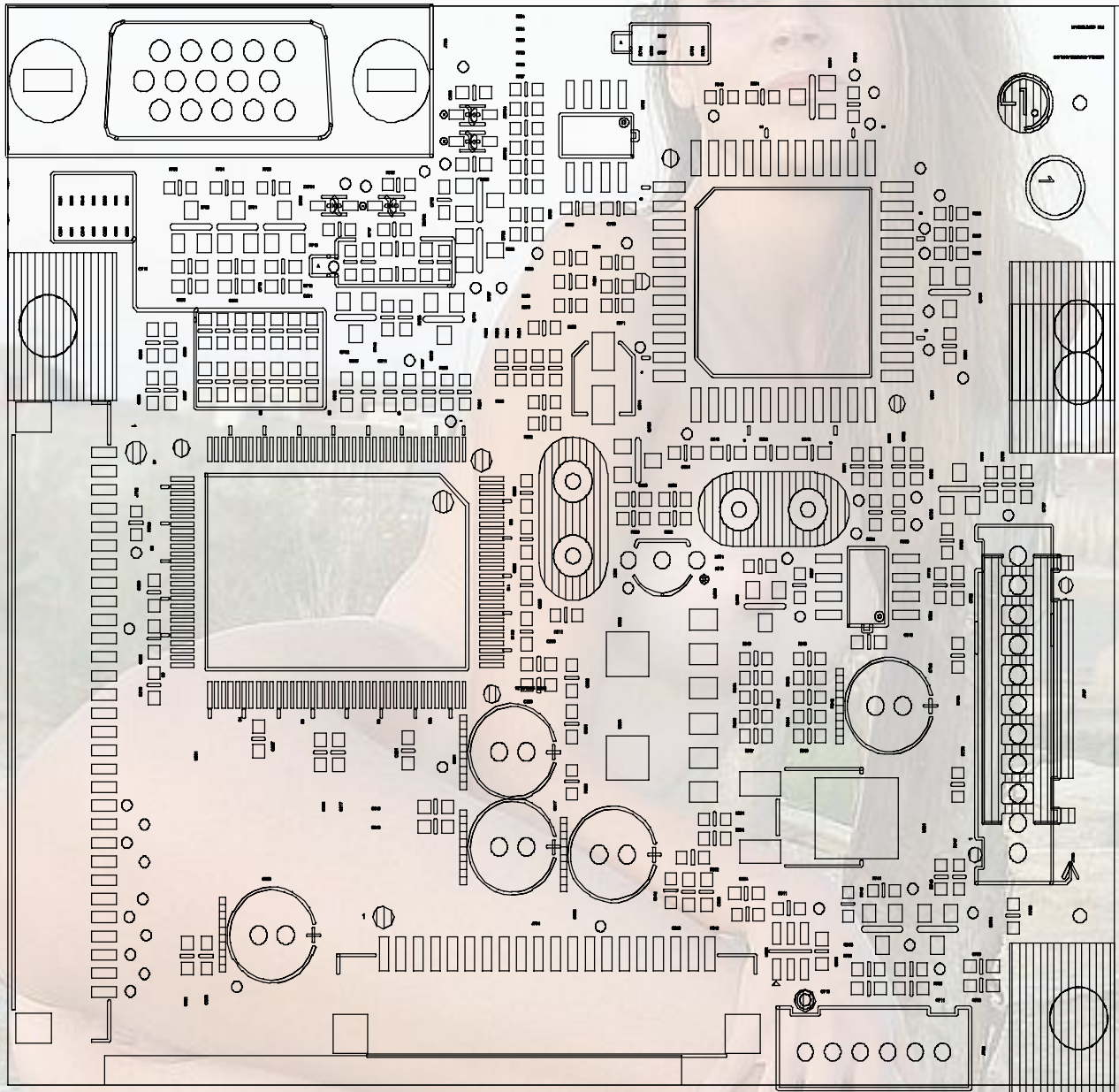

## 2. MAIN BOARD (Solder Side)

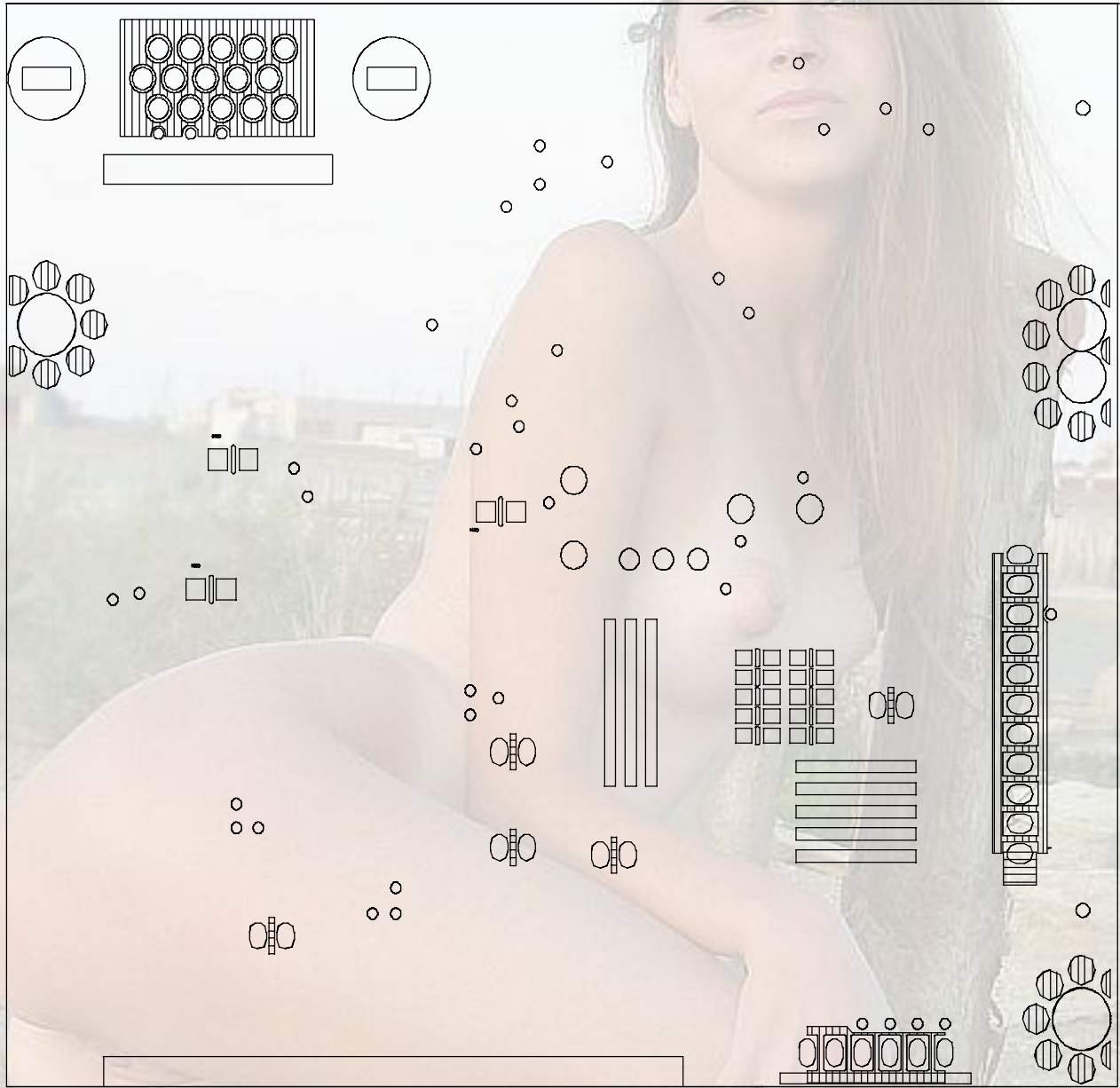

## 3. CONTROL BOARD

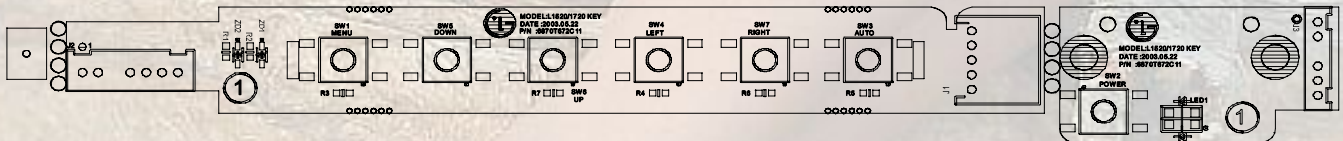

**EXPLODED VIEW**

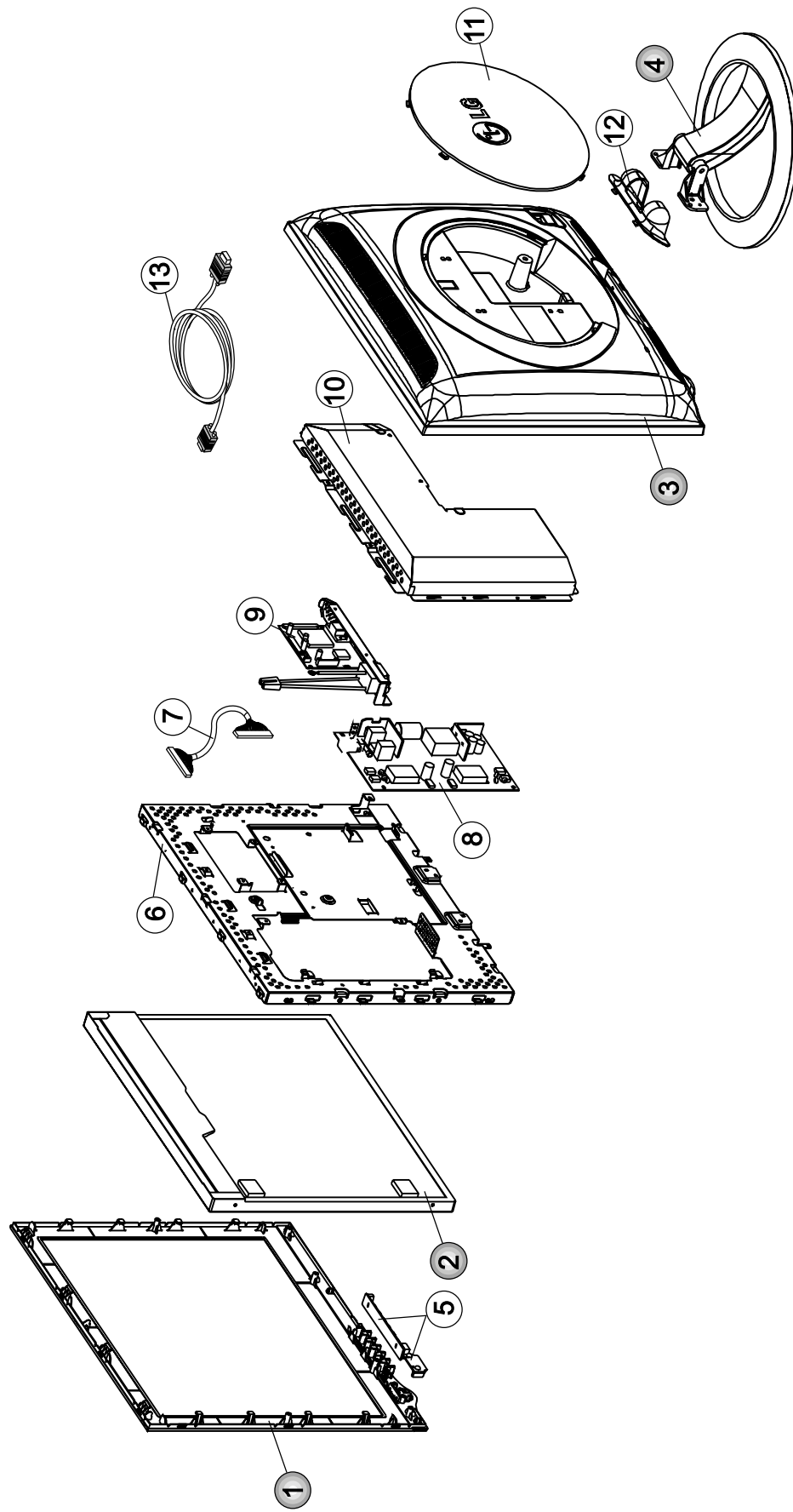



## EXPLODED VIEW PARTS LIST

Ref. No.	Part No.	Description
1	3091TKL086A	CABINET ASSEMBLY, L1720 BRAND . .
2	6304FLP058A or 6304FLP086A or 6304FLP085A or 6304FLP076A	LCD(LIQUID CRYSTAL DISPLAY) LM170E01-A4 LG PHILPS TFT COLOR 17" TFT LCD LCD(LIQUID CRYSTAL DISPLAY), LM170E01-A5K6 LG PHILPS TFT COLOR LVDS SXGA OKY GATE D-IC LCD(LIQUID CRYSTAL DISPLAY), LM170E01-A4K4 LG PHILPS TFT COLOR SXGA LVDS OKI GATE D-IC LCD(LIQUID CRYSTAL DISPLAY) LM170E01-A5 LG PHILPS TFT COLOR LVDS SXGA
3	3809TKL059A	BACK COVER ASSEMBLY, L1720 . SILVER SPRAY
4	3043TKK134A	TILT SWIVEL ASSEMBLY , L1720BL. SILVER+CR
5	6871TST430A	PWB(PCB) ASSEMBLY,SUB, L1720BL CONTROL TOTAL BRAND CL-43
6	4951TKS111A	METAL ASSEMBLY, FRAME L1720BL LPL
7	6631T11012W	CONNECTOR ASSEMBLY, 30P H-H 200MM UL20276 LG708G
8	6871TPT237C	PWB(PCB) ASSEMBLY, POWER, LS71K POWER TOTAL POWERNET PWI1704S(L)12V/1.2A 5V/1A LIPS FOR LPL
9	6871TMT461A	PWB(PCB) ASSEMBLY, MAIN, L1720BL ALRDR BRAND CL-43 TOTAL
10	4951TKK139A	METAL ASSEMBLY, REAR L1720BL
11	3550TKK398A	COVER, L1720 BACK CAP
12	3550TKK400A	COVER, L1720BL HINGE CAP
13	6850TD9004D	CABLE, D-SUB, UL20276-9C(5.8MM) DT 1560MM GRAY(85964) LB500L DM

# REPLACEMENT PARTS LIST

**CAUTION:** BEFORE REPLACING ANY OF THESE COMPONENTS, READ CAREFULLY THE **SAFETY PRECAUTIONS** IN THIS MANUAL.

\* NOTE : **S** SAFETY Mark **AL** ALTERNATIVE PARTS

DATE: 2003. 6. 14.				
*S	*AL	LOC. NO.	PART NO.	DESCRIPTION / SPECIFICATION
<b>MAIN BOARD</b>				
<b>CAPACITORS</b>				
		C204	0CK104CK56A	0.1UF 1608 50V 10% R/TP X7R
		C205	0CK104CK56A	0.1UF 1608 50V 10% R/TP X7R
		C206	0CK104CK56A	0.1UF 1608 50V 10% R/TP X7R
		C207	0CK104CK56A	0.1UF 1608 50V 10% R/TP X7R
		C208	0CK104CK56A	0.1UF 1608 50V 10% R/TP X7R
		C209	0CK104CK56A	0.1UF 1608 50V 10% R/TP X7R
		C210	0CK104CK56A	0.1UF 1608 50V 10% R/TP X7R
		C211	0CK104CK56A	0.1UF 1608 50V 10% R/TP X7R
		C212	0CK104CK56A	0.1UF 1608 50V 10% R/TP X7R
		C215	0CK104CK56A	0.1UF 1608 50V 10% R/TP X7R
		C216	0CK104CK56A	0.1UF 1608 50V 10% R/TP X7R
		C217	0CK104CK56A	0.1UF 1608 50V 10% R/TP X7R
		C218	0CK104CK56A	0.1UF 1608 50V 10% R/TP X7R
		C219	0CK104CK56A	0.1UF 1608 50V 10% R/TP X7R
		C220	0CK104CK56A	0.1UF 1608 50V 10% R/TP X7R
		C221	0CK104CK56A	0.1UF 1608 50V 10% R/TP X7R
		C222	0CK104CK56A	0.1UF 1608 50V 10% R/TP X7R
		C223	0CK104CK56A	0.1UF 1608 50V 10% R/TP X7R
		C225	0CK104CK56A	0.1UF 1608 50V 10% R/TP X7R
		C226	0CK104CK56A	0.1UF 1608 50V 10% R/TP X7R
		C227	0CK104CK56A	0.1UF 1608 50V 10% R/TP X7R
		C230	0CK104CK56A	0.1UF 1608 50V 10% R/TP X7R
		C231	0CK104CK56A	0.1UF 1608 50V 10% R/TP X7R
		C232	0CK104CK56A	0.1UF 1608 50V 10% R/TP X7R
		C233	0CK104CK56A	0.1UF 1608 50V 10% R/TP X7R
		C240	0CK104CK56A	0.1UF 1608 50V 10% R/TP X7R
		C501	0CK104CK56A	0.1UF 1608 50V 10% R/TP X7R
		C502	0CC101CK41A	100PF 1608 50V 5% R/TP NP0
		C503	0CC101CK41A	100PF 1608 50V 5% R/TP NP0
		C505	0CC101CK41A	100PF 1608 50V 5% R/TP NP0
		C506	0CC101CK41A	100PF 1608 50V 5% R/TP NP0
		C512	0CC180CK41A	18PF 1608 50V 5% R/TP NP0
		C513	0CC030CK01A	3PF 1608 50V 0.25 PF R/TP NP0
		C514	0CH8106F611	10UF 16V M 85STD(CYL) R/TP
		C516	0CK104CK56A	0.1UF 1608 50V 10% R/TP X7R
		C550	0CC102CK41A	1000PF 1608 50V 5% R/TP NP0
		C703	0CK104CK56A	0.1UF 1608 50V 10% R/TP X7R
		C707	0CC680CK41A	68PF 1608 50V 5% R/TP NP0
		C708	0CK103CK51A	0.01UF 1608 50V 10% R/TP B(Y5)
		C709	0CK103CK51A	0.01UF 1608 50V 10% R/TP B(Y5)
		C710	0CK103CK51A	0.01UF 1608 50V 10% R/TP B(Y5)
		C711	0CK103CK51A	0.01UF 1608 50V 10% R/TP B(Y5)
		C712	0CK104CK56A	0.1UF 1608 50V 10% R/TP X7R
		C713	0CK104CK56A	0.1UF 1608 50V 10% R/TP X7R
		C714	0CK104CK56A	0.1UF 1608 50V 10% R/TP X7R
		C715	0CK104CK56A	0.1UF 1608 50V 10% R/TP X7R
		C727	0CK105CD56A	1UF 1608 10V 10% R/TP X7R
		C730	0CC101CK41A	100PF 1608 50V 5% R/TP NP0
		C731	0CC680CK41A	68PF 1608 50V 5% R/TP NP0
		C732	0CK103CK51A	0.01UF 1608 50V 10% R/TP B(Y5)
		C760	0CE107EF610	100UF KMG,RD 16V 20% FL BULK
		C801	0CK103CK51A	0.01UF 1608 50V 10% R/TP B(Y5)

DATE: 2003. 6. 14.				
*S	*AL	LOC. NO.	PART NO.	DESCRIPTION / SPECIFICATION
		C802	0CK104CK56A	0.1UF 1608 50V 10% R/TP X7R
		C803	0CK105CD56A	1UF 1608 10V 10% R/TP X7R
		C804	0CC102CK41A	1000PF 1608 50V 5% R/TP NP0
		C817	0CE107EF610	100UF KMG,RD 16V 20% FL BULK
		C818	0CK104CK56A	0.1UF 1608 50V 10% R/TP X7R
		C819	0CK103CK51A	0.01UF 1608 50V 10% R/TP B(Y5)
		C820	0CE107EF610	100UF KMG,RD 16V 20% FL BULK
		C821	0CK103CK51A	0.01UF 1608 50V 10% R/TP B(Y5)
		C822	0CK104CK56A	0.1UF 1608 50V 10% R/TP X7R
		C828	0CK104CK56A	0.1UF 1608 50V 10% R/TP X7R
		C829	0CK103CK51A	0.01UF 1608 50V 10% R/TP B(Y5)
		C831	0CE107EF610	100UF KMG,RD 16V 20% FL BULK
		C832	0CE107EF610	100UF KMG,RD 16V 20% FL BULK
<b>DIODEs</b>				
		D701	0DS226009AA	KDS226 TP KEC SOT-23 80V 300
		D702	0DS226009AA	KDS226 TP KEC SOT-23 80V 300
		D703	0DS226009AA	KDS226 TP KEC SOT-23 80V 300
		D706	0DS226009AA	KDS226 TP KEC SOT-23 80V 300
		D707	0DD184009AA	KDS184 TP KEC - 85V - - - 300
		ZD701	0DZ560009GB	BZT52C5V6S DIODES R/TP SOD323
		ZD702	0DZ560009GB	BZT52C5V6S DIODES R/TP SOD323
		ZD703	0DZ560009GB	BZT52C5V6S DIODES R/TP SOD323
		ZD704	0DZ560009GB	BZT52C5V6S DIODES R/TP SOD323
<b>ICs</b>				
		U201	0IPRPM3004A	MST9111 ANALOG MSTAR 128 LQFP
		U501	0IZZTSZ282A	MYSON 44P PLCC ST OPT L1720BL
		U502	0ISG240860B	M24C08W6 SGS-THOMSON 8SOP R/T
		U702	0ICS240213A	CAT24WC02J-TE13 8P SOP TP 2K
		U802	0TFV180023A	VISHAY SI3865DV R/TP TSOP-6 8
		U803	0IPMGNS001D	LM1117MPX-2.5 NATIONAL SEMICO
		U804	0IPMGNS001E	LM1117MPX-3.3 NATIONAL SEMICO
<b>TRANSISTOR</b>				
		Q502	0TR390409AE	FAIRCHILD KST3904(LGEMTF) TP
		Q503	0IKE704200H	KIA7042AP TO-92 TP 4.2 VOLT.
		Q504	0TR390409AE	FAIRCHILD KST3904(LGEMTF) TP
		Q505	0TR390409AE	FAIRCHILD KST3904(LGEMTF) TP
		Q506	0TR390409AE	FAIRCHILD KST3904(LGEMTF) TP
		Q701	0TR390409AE	FAIRCHILD KST3904(LGEMTF) TP
		Q702	0TR390409AE	FAIRCHILD KST3904(LGEMTF) TP
		Q703	0TR390609FA	KST3906-MTF TP SAMSUNG SOT23
		Q704	0TR390609FA	KST3906-MTF TP SAMSUNG SOT23
		Q705	0TR390409AE	FAIRCHILD KST3904(LGEMTF) TP
<b>RESISTORS</b>				
		R201	0RJ0682D677	68 OHM 1/10 W 5% 1608 R/TP
		R202	0RJ0682D677	68 OHM 1/10 W 5% 1608 R/TP
		R203	0RJ0682D677	68 OHM 1/10 W 5% 1608 R/TP



DATE: 2003. 6. 14.				
*S	*AL	LOC. NO.	PART NO.	DESCRIPTION / SPECIFICATION
		R204	0RJ1002D677	10K OHM 1/10 W 5% 1608 R/TP
		R205	0RJ1002D677	10K OHM 1/10 W 5% 1608 R/TP
		R207	0RJ4700D677	470 OHM 1/10 W 5% 1608 R/TP
		R208	0RJ0682D677	68 OHM 1/10 W 5% 1608 R/TP
		R209	0RJ0682D677	68 OHM 1/10 W 5% 1608 R/TP
		R210	0RJ0682D677	68 OHM 1/10 W 5% 1608 R/TP
		R240	0RJ0682D677	68 OHM 1/10 W 5% 1608 R/TP
		R501	0RJ4701D677	4.7K OHM 1/10 W 5% 1608 R/TP
		R502	0RJ4701D677	4.7K OHM 1/10 W 5% 1608 R/TP
		R504	0RJ4701D677	4.7K OHM 1/10 W 5% 1608 R/TP
		R509	0RJ4701D677	4.7K OHM 1/10 W 5% 1608 R/TP
		R510	0RJ4700D677	470 OHM 1/10 W 5% 1608 R/TP
		R511	0RJ4700D677	470 OHM 1/10 W 5% 1608 R/TP
		R515	0RJ1002D677	10K OHM 1/10 W 5% 1608 R/TP
		R520	0RJ1003D677	100K OHM 1/10 W 5% 1608 R/TP
		R522	0RJ1000D677	100 OHM 1/10 W 5% 1608 R/TP
		R523	0RJ0332D677	33 OHM 1/10 W 5% 1608 R/TP
		R524	0RJ0332D677	33 OHM 1/10 W 5% 1608 R/TP
		R525	0RJ1002D677	10K OHM 1/10 W 5% 1608 R/TP
		R528	0RJ1000D677	100 OHM 1/10 W 5% 1608 R/TP
		R529	0RJ1000D677	100 OHM 1/10 W 5% 1608 R/TP
		R530	0RJ1000D677	100 OHM 1/10 W 5% 1608 R/TP
		R531	0RJ1000D677	100 OHM 1/10 W 5% 1608 R/TP
		R532	0RJ3301D677	3.3K OHM 1/10 W 5% 1608 R/TP
		R533	0RJ0332D677	33 OHM 1/10 W 5% 1608 R/TP
		R534	0RJ0332D677	33 OHM 1/10 W 5% 1608 R/TP
		R535	0RJ3301D677	3.3K OHM 1/10 W 5% 1608 R/TP
		R537	0RJ4701D677	4.7K OHM 1/10 W 5% 1608 R/TP
		R540	0RJ1002D677	10K OHM 1/10 W 5% 1608 R/TP
		R541	0RJ4701D677	4.7K OHM 1/10 W 5% 1608 R/TP
		R551	0RJ4702D677	47000 OHM 1/10 W 5% 1608 R/TP
		R571	0RJ1000D677	100 OHM 1/10 W 5% 1608 R/TP
		R581	0RJ1000D677	100 OHM 1/10 W 5% 1608 R/TP
		R590	0RJ1000D677	100 OHM 1/10 W 5% 1608 R/TP
		R591	0RJ1000D677	100 OHM 1/10 W 5% 1608 R/TP
		R592	0RJ1000D677	100 OHM 1/10 W 5% 1608 R/TP
		R593	0RJ1000D677	100 OHM 1/10 W 5% 1608 R/TP
		R701	0RJ0752D677	75 OHM 1/10 W 5% 1608 R/TP
		R703	0RJ0752D677	75 OHM 1/10 W 5% 1608 R/TP
		R705	0RJ1501D677	1.5K OHM 1/10 W 5% 1608 R/TP
		R706	0RJ0752D677	75 OHM 1/10 W 5% 1608 R/TP
		R707	0RJ0682D677	68 OHM 1/10 W 5% 1608 R/TP
		R708	0RJ4700D677	470 OHM 1/10 W 5% 1608 R/TP
		R709	0RJ1001D677	1K OHM 1/10 W 5% 1608 R/TP
		R716	0RJ4701D677	4.7K OHM 1/10 W 5% 1608 R/TP
		R717	0RJ4701D677	4.7K OHM 1/10 W 5% 1608 R/TP
		R722	0RJ1000D677	100 OHM 1/10 W 5% 1608 R/TP
		R723	0RJ0332D677	33 OHM 1/10 W 5% 1608 R/TP
		R724	0RJ0332D677	33 OHM 1/10 W 5% 1608 R/TP
		R725	0RJ4701D677	4.7K OHM 1/10 W 5% 1608 R/TP
		R726	0RJ1002D677	10K OHM 1/10 W 5% 1608 R/TP
		R727	0RJ1002D677	10K OHM 1/10 W 5% 1608 R/TP
		R733	0RJ1001D677	1K OHM 1/10 W 5% 1608 R/TP
		R734	0RJ4701D677	4.7K OHM 1/10 W 5% 1608 R/TP
		R735	0RJ0000D677	0 OHM 1/10 W 5% 1608 R/TP
		R740	0RJ1001D677	1K OHM 1/10 W 5% 1608 R/TP
		R741	0RJ4701D677	4.7K OHM 1/10 W 5% 1608 R/TP
		R744	0RJ4701D677	4.7K OHM 1/10 W 5% 1608 R/TP
		R745	0RJ4701D677	4.7K OHM 1/10 W 5% 1608 R/TP
		R747	0RJ4701D677	4.7K OHM 1/10 W 5% 1608 R/TP
		R748	0RJ4701D677	4.7K OHM 1/10 W 5% 1608 R/TP
		R750	0RJ1001D677	1K OHM 1/10 W 5% 1608 R/TP

DATE: 2003. 6. 14.				
*S	*AL	LOC. NO.	PART NO.	DESCRIPTION / SPECIFICATION
		R751	0RJ1001D677	1K OHM 1/10 W 5% 1608 R/TP
		R753	0RJ1001D677	1K OHM 1/10 W 5% 1608 R/TP
		R769	0RJ0000D677	0 OHM 1/10 W 5% 1608 R/TP
		R770	0RJ0000D677	0 OHM 1/10 W 5% 1608 R/TP
		R801	0RJ0000D677	0 OHM 1/10 W 5% 1608 R/TP
		R803	0RJ0000D677	0 OHM 1/10 W 5% 1608 R/TP
		R804	0RJ0000D677	0 OHM 1/10 W 5% 1608 R/TP
		R811	0RJ2202D677	22K OHM 1/10 W 5% 1608 R/TP
		R812	0RJ5600D677	560 OHM 1/10 W 5% 1608 R/TP
		R840	0RJ0332D677	33 OHM 1/10 W 5% 1608 R/TP
		R841	0RJ0332D677	33 OHM 1/10 W 5% 1608 R/TP
		R842	0RJ0332D677	33 OHM 1/10 W 5% 1608 R/TP
		R843	0RJ0332D677	33 OHM 1/10 W 5% 1608 R/TP
		R844	0RJ0332D677	33 OHM 1/10 W 5% 1608 R/TP
		R845	0RJ0332D677	33 OHM 1/10 W 5% 1608 R/TP
		R846	0RJ0332D677	33 OHM 1/10 W 5% 1608 R/TP
		R847	0RJ0332D677	33 OHM 1/10 W 5% 1608 R/TP
		R848	0RJ0332D677	33 OHM 1/10 W 5% 1608 R/TP
		R849	0RJ0332D677	33 OHM 1/10 W 5% 1608 R/TP
<b>OTHERs</b>				
		X501	6212AA2004A	HC-49U TXC 12.0MHZ +/- 30 PPM
<b>CONTROL BOARD</b>				
		R1	0RJ4701D677	4.7K OHM 1/10 W 5% 1608 R/TP
		R2	0RJ4701D677	4.7K OHM 1/10 W 5% 1608 R/TP
		R3	0RJ1501D677	1.5K OHM 1/10 W 5% 1608 R/TP
		R4	0RJ1501D677	1.5K OHM 1/10 W 5% 1608 R/TP
		R5	0RJ3301D677	3.3K OHM 1/10 W 5% 1608 R/TP
		R6	0RJ3301D677	3.3K OHM 1/10 W 5% 1608 R/TP
		R7	0RJ9101D677	9.1K OHM 1/10 W 5% 1608 R/TP
		SW1	6600R00004A	JTP1138A6EM JEIL 12VDC 50MA S
		SW2	6600R00004A	JTP1138A6EM JEIL 12VDC 50MA S
		SW3	6600R00004A	JTP1138A6EM JEIL 12VDC 50MA S
		SW4	6600R00004A	JTP1138A6EM JEIL 12VDC 50MA S
		SW5	6600R00004A	JTP1138A6EM JEIL 12VDC 50MA S
		SW6	6600R00004A	JTP1138A6EM JEIL 12VDC 50MA S
		SW7	6600R00004A	JTP1138A6EM JEIL 12VDC 50MA S
		ZD1	0DZ560009GB	BZT52C5V6S DIODES R/TP SOD323
		ZD2	0DZ560009GB	BZT52C5V6S DIODES R/TP SOD323



# PIN CONFIGURATION

## MST9111 DUAL MSTAR 128P

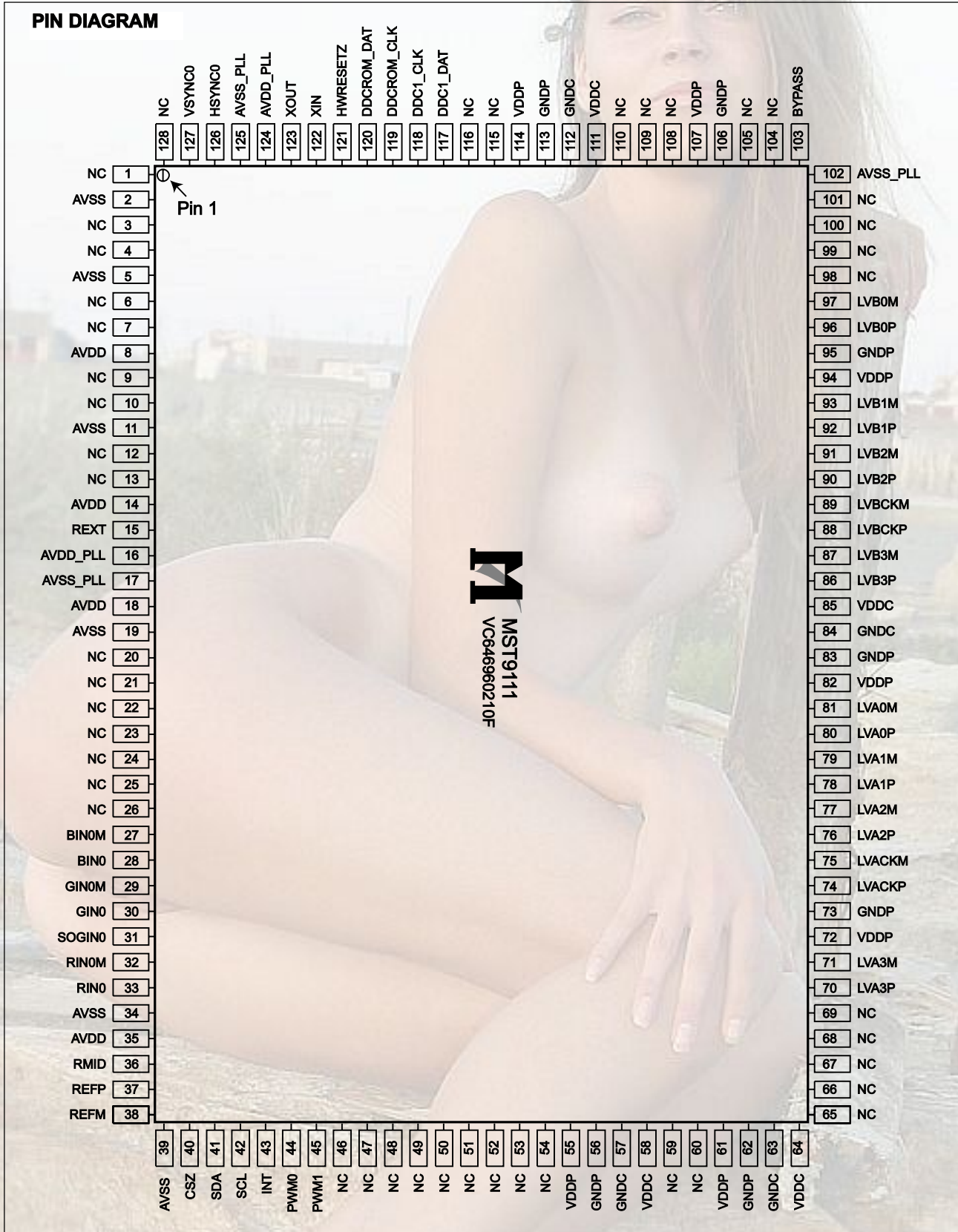

# SCHEMATIC DIAGRAM

## 1. SCALER

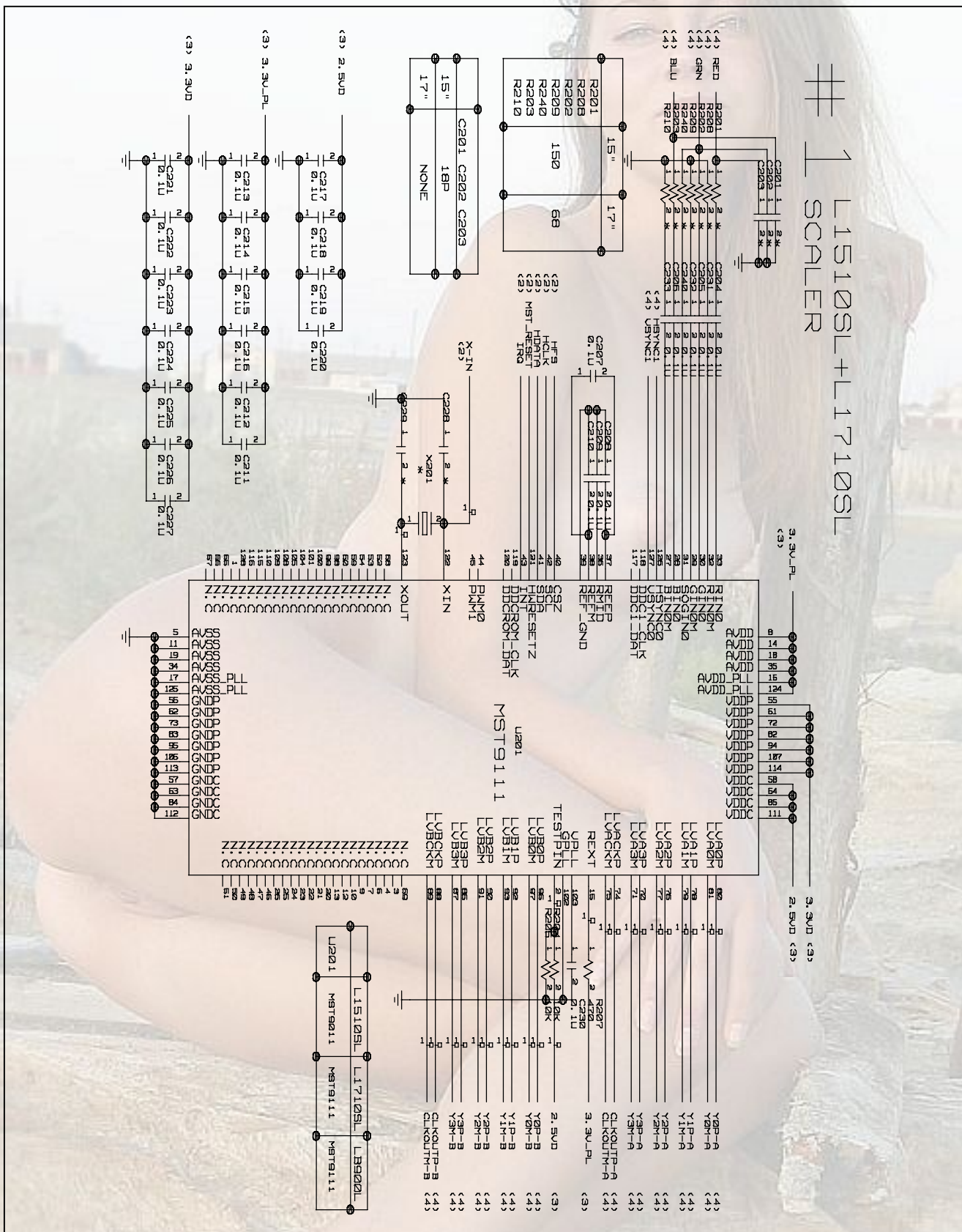

## 2. MICOM

#2 L1510SL+L1710SL  
MICOM

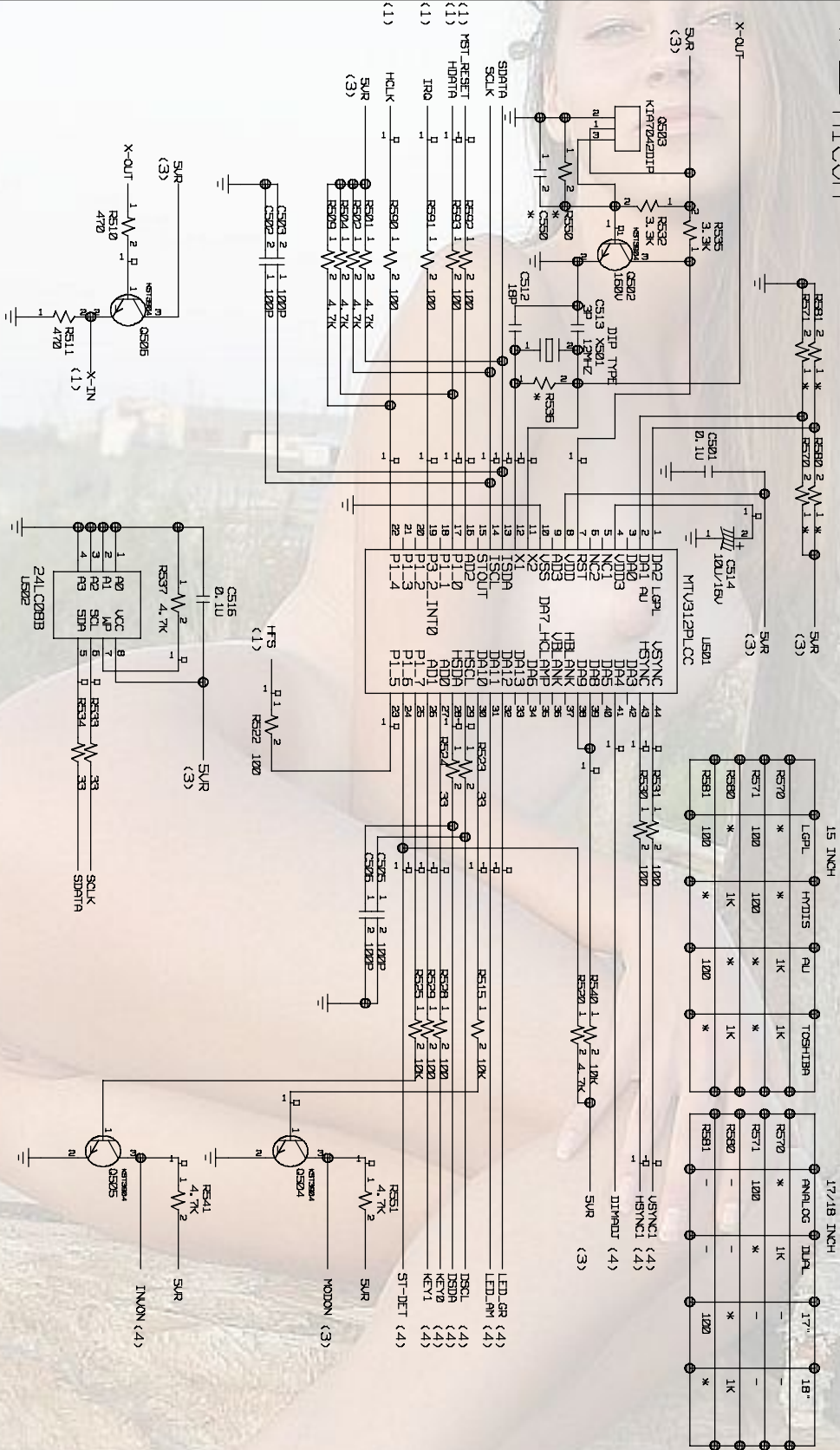







# 5.KEY

L1520/1720 KEY

2003. 05

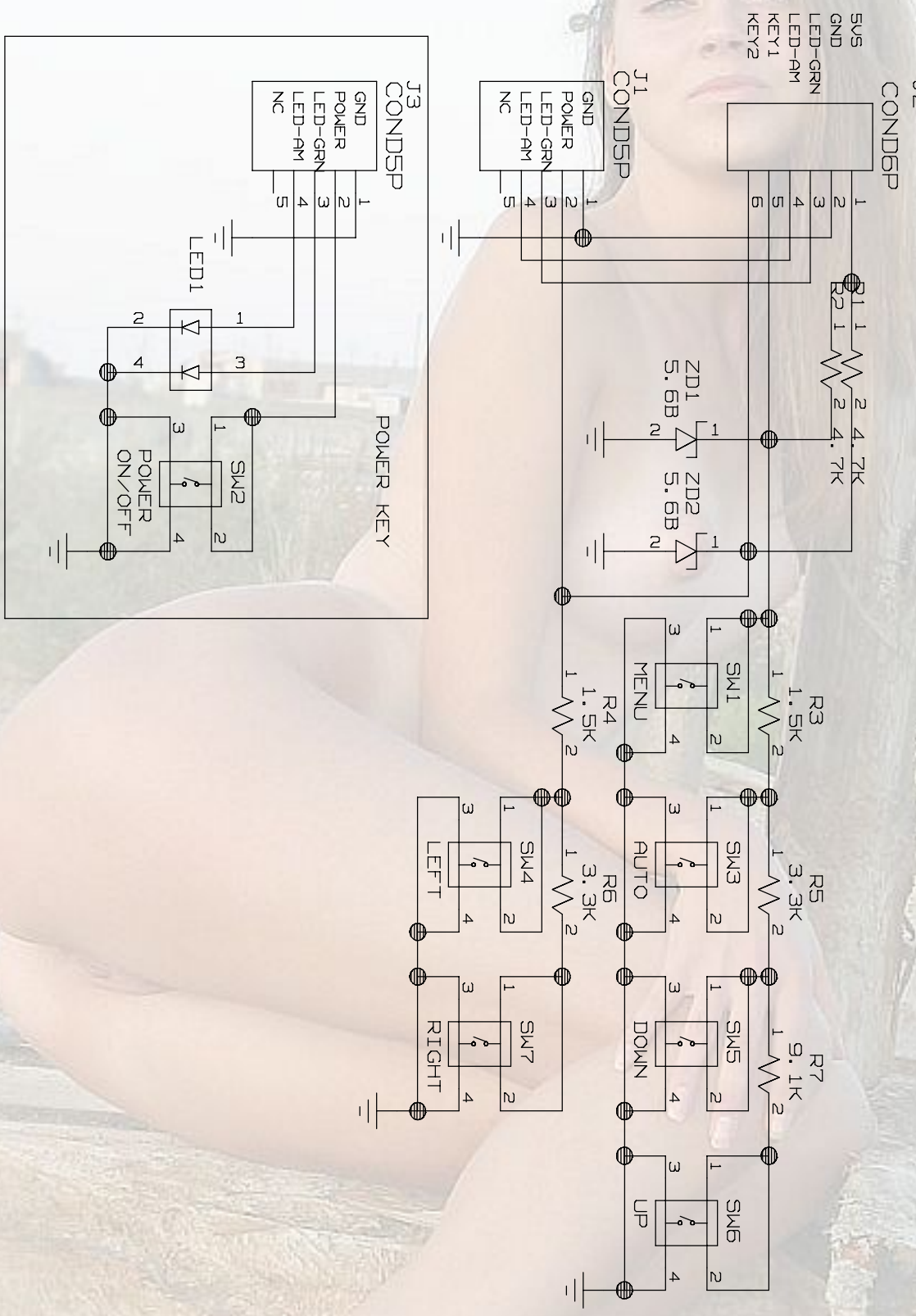





P/NO : 3828TSL074T

Jun. 2003  
Printed in Korea