



Website:<http://biz.LGservice.com>
E-mail:<http://www.LGService.com/techsup.html>

COLOR MONITOR

SERVICE MANUAL

CHASSIS NO. : LM57B

MODEL: FLATRON L1752T (L1752T-SFQ.AX**QP)
FLATRON L1752T (L1752T-BFQ.AX**QP)
FLATRON L1952T (L1952T-SFQ.AX**QP)
FLATRON L1952T (L1952T-BFQ.AX**QP)

() **Same model for Service

CAUTION

BEFORE SERVICING THE UNIT,
READ THE **SAFETY PRECAUTIONS** IN THIS MANUAL.

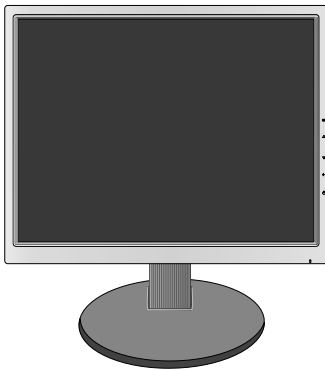

*To apply the **MSTAR Chip**.

CONTENTS

SPECIFICATIONS	2	SERVICE OSD	15
PRECAUTIONS	3	TROUBLESHOOTING GUIDE	16
TIMING CHART	7	WIRING DIAGRAM	22
DISASSEMBLY	8	EXPLODED VIEW	23
BLOCK DIAGRAM.....	10	REPLACEMENT PARTS LIST	25
DISCRIPTION OF BLOCK DIAGRAM	12	SCHEMATIC DIAGRAM.....	30
ADJUSTMENT	14		

SPECIFICATIONS

1. LCD CHARACTERISTICS

Type : TFT Color LCD Module
 Active Display Area : 17 inch - **L1752T**
 : 19 inch - **L1952T**
 Pixel Pitch : 0.264 (H) x 0.264 (V) - **L1752T**
 : 0.294 (H) x 0.294 (V) - **L1952T**
 Color Depth : 8bits, 16.2M colors
 Size : 358.5 (H) x 296.5 (V) x 17.0(D) - **L1752T**
 : 396 (H) x 324 (V) x 17.5(D) - **L1952T**
 Electrical Interface : LVDS
 Surface Treatment : Hard-coating(3H), Anti-Glare
 Operating Mode : Normally White, Transmissive mode
 Backlight Unit : 4-CCFL

2. OPTICAL CHARACTERISTICS

2-1. Viewing Angle by Contrast Ratio ≥ 10

Left : -60° min., -70°(Typ) Right : +60° min., +70°(Typ)
 Top : +60° min., +75°(Typ) Bottom : -50° min., -65°(Typ)

2-2. Luminance : 230(min), 300(Typ) (Full White pattern, 0.70V) -**6500K**
 : 150(min) (Full White pattern, 0.70V) -**9300K**
 75%(min)

2-3. Contrast Ratio : 1400:1 (DFC)

3. SIGNAL (Refer to the Timing Chart)

3-1. Sync Signal
 • Type : Separate Sync, Digital, SOG

3-2. Video Input Signal
 1) Type : R, G, B Analog
 2) Voltage Level : 0~0.71 V
 a) Color 0, 0 : 0 Vp-p
 b) Color 7, 0 : 0.467Vp-p
 c) Color 15, 0 : 0.714Vp-p
 3) Input Impedance : 75Ω

3-3. Operating Frequency
 Horizontal : 30 ~ 83kHz
 Vertical : 56 ~ 75Hz

4. Max. Resolution

D-sub Analog : 1280 x 1024@75Hz
 Digital : 1280 x 1024@60Hz

5. POWER SUPPLY

5-1. Power : AC 100~240V, 50/60Hz , 0.6A

5-2. Power Consumption

MODE	H/V SYNC	VIDEO	POWER CONSUMPTION	LED COLOR
POWER ON (NORMAL)	ON/ON	ACTIVE	less than 33 W - L1752T	BLUE or GREEN
			less than 37 W - L1952T	
STAND-BY	OFF/ON	OFF	less than 1 W	AMBER
SUSPEND	ON/OFF	OFF	less than 1 W	AMBER
DPMS OFF	OFF/OFF	OFF	less than 1 W	AMBER
POWER S/W Off	-	-	less than 1 W	OFF

6. ENVIRONMENT

6-1. Operating Temperature : 10°C~35°C (50°F~95°F)
 (Ambient)

6-2. Relative Humidity : 10%~80% (Non-condensing)

6-3. MTBF : 50,000 HRS with 90% Confidence
 Lamp Life : 50,000 Hours(Min)

7. DIMENSIONS (with TILT/SWIVEL)

L1752T
 Width : 364.5 mm (14.35")
 Depth : 180 mm (7.09")
 Height : 378.2 mm (14.89")

L1952T
 Width : 402 mm (15.83")
 Depth : 180 mm (7.09")
 Height : 407.5 mm (16.04")

8. WEIGHT (with TILT/SWIVEL)

L1752T
 Net. Weight : 3.5 kg (7.72 lbs)
 Gross Weight : 4.6 kg (10.14 lbs)

L1952T
 Net. Weight : 4.4 kg (9.70 lbs)
 Gross Weight : 5.6 kg (12.35 lbs)

PRECAUTION

WARNING FOR THE SAFETY-RELATED COMPONENT.

- There are some special components used in LCD monitor that are important for safety. **These parts are marked \triangle on the schematic diagram and the replacement parts list.** It is essential that these critical parts should be replaced with the manufacturer's specified parts to prevent electric shock, fire or other hazard.
- Do not modify original design without obtaining written permission from manufacturer or you will void the original parts and labor guarantee.

TAKE CARE DURING HANDLING THE LCD MODULE WITH BACKLIGHT UNIT.

- Must mount the module using mounting holes arranged in four corners.
- Do not press on the panel, edge of the frame strongly or electric shock as this will result in damage to the screen.
- Do not scratch or press on the panel with any sharp objects, such as pencil or pen as this may result in damage to the panel.
- Protect the module from the ESD as it may damage the electronic circuit (C-MOS).
- Make certain that treatment person's body are grounded through wrist band.
- Do not leave the module in high temperature and in areas of high humidity for a long time.
- The module not be exposed to the direct sunlight.
- Avoid contact with water as it may a short circuit within the module.
- If the surface of panel become dirty, please wipe it off with a softmaterial. (Cleaning with a dirty or rough cloth may damage the panel.)

\triangle CAUTION

Please use only a plastic screwdriver to protect yourself from shock hazard during service operation.

\triangle WARNING

BE CAREFUL ELECTRIC SHOCK !

- If you want to replace with the new backlight (CCFL) or inverter circuit, must disconnect the AC adapter because high voltage appears at inverter circuit about 650Vrms.
- Handle with care wires or connectors of the inverter circuit. If the wires are pressed cause short and may burn or take fire.

Leakage Current Hot Check Circuit

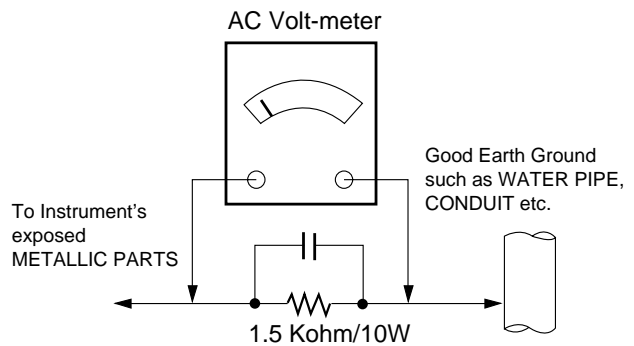

SERVICING PRECAUTIONS

CAUTION: Before servicing receivers covered by this service manual and its supplements and addenda, read and follow the **SAFETY PRECAUTIONS** on page 3 of this publication.

NOTE: If unforeseen circumstances create conflict between the following servicing precautions and any of the safety precautions on page 3 of this publication, always follow the safety precautions. Remember: Safety First.

General Servicing Precautions

1. Always unplug the receiver AC power cord from the AC power source before;
 - a. Removing or reinstalling any component, circuit board module or any other receiver assembly.
 - b. Disconnecting or reconnecting any receiver electrical plug or other electrical connection.
 - c. Connecting a test substitute in parallel with an electrolytic capacitor in the receiver.
CAUTION: A wrong part substitution or incorrect polarity installation of electrolytic capacitors may result in an explosion hazard.
 - d. Discharging the picture tube anode.
2. Test high voltage only by measuring it with an appropriate high voltage meter or other voltage measuring device (DVM, FETVOM, etc) equipped with a suitable high voltage probe.
Do not test high voltage by "drawing an arc".
3. Discharge the picture tube anode only by (a) first connecting one end of an insulated clip lead to the degaussing or kine aquadag grounding system shield at the point where the picture tube socket ground lead is connected, and then (b) touch the other end of the insulated clip lead to the picture tube anode button, using an insulating handle to avoid personal contact with high voltage.
4. Do not spray chemicals on or near this receiver or any of its assemblies.
5. Unless specified otherwise in this service manual, clean electrical contacts only by applying the following mixture to the contacts with a pipe cleaner, cotton-tipped stick or comparable non-abrasive applicator; 10% (by volume) Acetone and 90% (by volume) isopropyl alcohol (90%-99% strength)
CAUTION: This is a flammable mixture.
Unless specified otherwise in this service manual, lubrication of contacts is not required.
6. Do not defeat any plug/socket B+ voltage interlocks with which receivers covered by this service manual might be equipped.
7. Do not apply AC power to this instrument and/or any of its electrical assemblies unless all solid-state device heat sinks are correctly installed.
8. Always connect the test receiver ground lead to the receiver chassis ground before connecting the test receiver positive lead.
Always remove the test receiver ground lead last.

9. Use with this receiver only the test fixtures specified in this service manual.

CAUTION: Do not connect the test fixture ground strap to any heat sink in this receiver.

Electrostatically Sensitive (ES) Devices

Some semiconductor (solid-state) devices can be damaged easily by static electricity. Such components commonly are called *Electrostatically Sensitive (ES) Devices*. Examples of typical ES devices are integrated circuits and some field-effect transistors and semiconductor "chip" components. The following techniques should be used to help reduce the incidence of component damage caused by static by static electricity.

1. Immediately before handling any semiconductor component or semiconductor-equipped assembly, drain off any electrostatic charge on your body by touching a known earth ground. Alternatively, obtain and wear a commercially available discharging wrist strap device, which should be removed to prevent potential shock reasons prior to applying power to the unit under test.
2. After removing an electrical assembly equipped with ES devices, place the assembly on a conductive surface such as aluminum foil, to prevent electrostatic charge buildup or exposure of the assembly.
3. Use only a grounded-tip soldering iron to solder or unsolder ES devices.
4. Use only an anti-static type solder removal device. Some solder removal devices not classified as "anti-static" can generate electrical charges sufficient to damage ES devices.
5. Do not use freon-propelled chemicals. These can generate electrical charges sufficient to damage ES devices.
6. Do not remove a replacement ES device from its protective package until immediately before you are ready to install it. (Most replacement ES devices are packaged with leads electrically shorted together by conductive foam, aluminum foil or comparable conductive material).
7. Immediately before removing the protective material from the leads of a replacement ES device, touch the protective material to the chassis or circuit assembly into which the device will be installed.
CAUTION: Be sure no power is applied to the chassis or circuit, and observe all other safety precautions.
8. Minimize bodily motions when handling unpackaged replacement ES devices. (Otherwise harmless motion such as the brushing together of your clothes fabric or the lifting of your foot from a carpeted floor can generate static electricity sufficient to damage an ES device.)

General Soldering Guidelines

1. Use a grounded-tip, low-wattage soldering iron and appropriate tip size and shape that will maintain tip temperature within the range of 500° F to 600° F.
2. Use an appropriate gauge of RMA resin-core solder composed of 60 parts tin/40 parts lead.
3. Keep the soldering iron tip clean and well tinned.
4. Thoroughly clean the surfaces to be soldered. Use a small wire-bristle (0.5 inch, or 1.25cm) brush with a metal handle.

Do not use freon-propelled spray-on cleaners.

5. Use the following unsoldering technique
 - a. Allow the soldering iron tip to reach normal temperature.
(500° F to 600° F)
 - b. Heat the component lead until the solder melts.
 - c. Quickly draw the melted solder with an anti-static, suction-type solder removal device or with solder braid.

CAUTION: Work quickly to avoid overheating the circuitboard printed foil.

6. Use the following soldering technique.
 - a. Allow the soldering iron tip to reach a normal temperature (500° F to 600° F)
 - b. First, hold the soldering iron tip and solder the strand against the component lead until the solder melts.
 - c. Quickly move the soldering iron tip to the junction of the component lead and the printed circuit foil, and hold it there only until the solder flows onto and around both the component lead and the foil.

CAUTION: Work quickly to avoid overheating the circuit board printed foil.

- d. Closely inspect the solder area and remove any excess or splashed solder with a small wire-bristle brush.

IC Remove/Replacement

Some chassis circuit boards have slotted holes (oblong) through which the IC leads are inserted and then bent flat against the circuit foil. When holes are the slotted type, the following technique should be used to remove and replace the IC. When working with boards using the familiar round hole, use the standard technique as outlined in paragraphs 5 and 6 above.

Removal

1. Desolder and straighten each IC lead in one operation by gently prying up on the lead with the soldering iron tip as the solder melts.
2. Draw away the melted solder with an anti-static suction-type solder removal device (or with solder braid) before removing the IC.

Replacement

1. Carefully insert the replacement IC in the circuit board.
2. Carefully bend each IC lead against the circuit foil pad and solder it.
3. Clean the soldered areas with a small wire-bristle brush. (It is not necessary to reapply acrylic coating to the areas).

"Small-Signal" Discrete Transistor Removal/Replacement

1. Remove the defective transistor by clipping its leads as close as possible to the component body.
2. Bend into a "U" shape the end of each of three leads remaining on the circuit board.
3. Bend into a "U" shape the replacement transistor leads.
4. Connect the replacement transistor leads to the corresponding leads extending from the circuit board and crimp the "U" with long nose pliers to insure metal to metal contact then solder each connection.

Power Output, Transistor Device Removal/Replacement

1. Heat and remove all solder from around the transistor leads.
2. Remove the heat sink mounting screw (if so equipped).
3. Carefully remove the transistor from the heat sink of the circuit board.
4. Insert new transistor in the circuit board.
5. Solder each transistor lead, and clip off excess lead.
6. Replace heat sink.

Diode Removal/Replacement

1. Remove defective diode by clipping its leads as close as possible to diode body.
2. Bend the two remaining leads perpendicular y to the circuit board.
3. Observing diode polarity, wrap each lead of the new diode around the corresponding lead on the circuit board.
4. Securely crimp each connection and solder it.
5. Inspect (on the circuit board copper side) the solder joints of the two "original" leads. If they are not shiny, reheat them and if necessary, apply additional solder.

Fuse and Conventional Resistor Removal/Replacement

1. Clip each fuse or resistor lead at top of the circuit board hollow stake.
2. Securely crimp the leads of replacement component around notch at stake top.
3. Solder the connections.

CAUTION: Maintain original spacing between the replaced component and adjacent components and the circuit board to prevent excessive component temperatures.

Circuit Board Foil Repair

Excessive heat applied to the copper foil of any printed circuit board will weaken the adhesive that bonds the foil to the circuit board causing the foil to separate from or "lift-off" the board. The following guidelines and procedures should be followed whenever this condition is encountered.

At IC Connections

To repair a defective copper pattern at IC connections use the following procedure to install a jumper wire on the copper pattern side of the circuit board. (Use this technique only on IC connections).

1. Carefully remove the damaged copper pattern with a sharp knife. (Remove only as much copper as absolutely necessary).
2. Carefully scratch away the solder resist and acrylic coating (if used) from the end of the remaining copper pattern.
3. Bend a small "U" in one end of a small gauge jumper wire and carefully crimp it around the IC pin. Solder the IC connection.
4. Route the jumper wire along the path of the out-away copper pattern and let it overlap the previously scraped end of the good copper pattern. Solder the overlapped area and clip off any excess jumper wire.

At Other Connections

Use the following technique to repair the defective copper pattern at connections other than IC Pins. This technique involves the installation of a jumper wire on the component side of the circuit board.

1. Remove the defective copper pattern with a sharp knife.

Remove at least 1/4 inch of copper, to ensure that a hazardous condition will not exist if the jumper wire opens.

2. Trace along the copper pattern from both sides of the pattern break and locate the nearest component that is directly connected to the affected copper pattern.
3. Connect insulated 20-gauge jumper wire from the lead of the nearest component on one side of the pattern break to the lead of the nearest component on the other side.

Carefully crimp and solder the connections.

CAUTION: Be sure the insulated jumper wire is dressed so the it does not touch components or sharp edges.

TIMING CHART

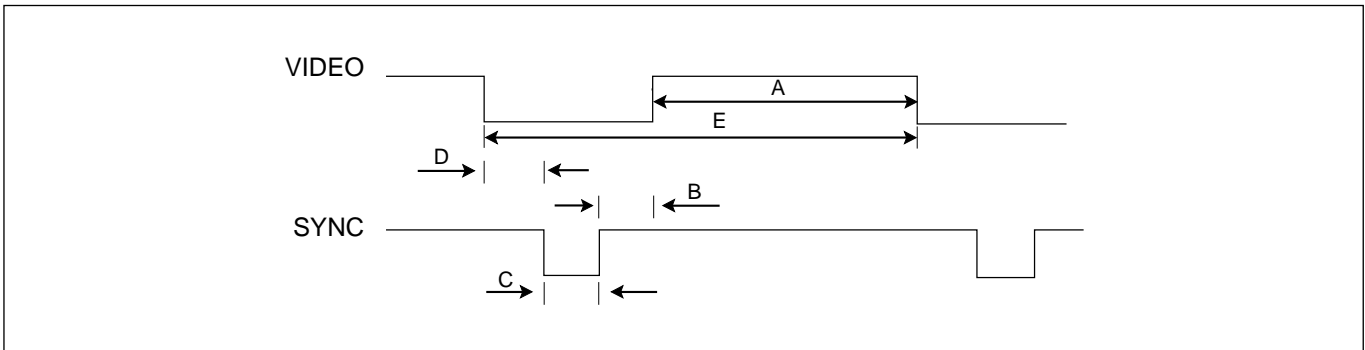

MODE	H / V	Sync Polarity	Dot Clock	Frequency	Total Period (E)	Video Active Time (A)	Sync Duration (D)	Front Porch (C)	Blanking Time (B)	Resolution
1	H(Pixels)	+	25.175	31.469	800	640	16	96	48	640 x 350
	V(Lines)	-		70.09	449	350	37	2	60	
2	H(Pixels)	-	28.321	31.468	900	720	18	108	54	720 X 400
	V(Lines)	+		70.08	449	400	12	2	35	
3	H(Pixels)	-	25.175	31.469	800	640	16	96	48	640 x 480
	V(Lines)	-		59.94	525	480	10	2	33	
4	H(Pixels)	-	31.5	37.5	840	640	16	64	120	640 x 480
	V(Lines)	-		75	500	480	1	3	16	
5	H(Pixels)	+	40.0	37.879	1056	800	40	128	88	800 x 600
	V(Lines)	+		60.317	628	600	1	4	23	
6	H(Pixels)	+	49.5	46.875	1056	800	16	80	160	800 x 600
	V(Lines)	+		75.0	625	600	1	3	21	
7	H(Pixels)	+/-	57.283	49.725	1152	832	32	64	224	832 x 624
	V(Lines)	+/-		74.55	667	624	1	3	39	
8	H(Pixels)	-	65.0	48.363	1344	1024	24	136	160	1024 x 768
	V(Lines)	-		60.0	806	768	3	6	29	
9	H(Pixels)	-	78.75	60.123	1312	1024	16	96	176	1024 x 768
	V(Lines)	-		75.029	800	768	1	3	28	
10	H(Pixels)	+/-	100.0	68.681	1456	1152	32	128	144	1152 x 870
	V(Lines)	+/-		75.062	915	870	3	3	39	
11	H(Pixels)	+/-	92.978	61.805	1504	1152	18	134	200	1152 x 900
	V(Lines)	+/-		65.96	937	900	2	4	31	
12	H(Pixels)	+	108.0	63.981	1688	1280	48	112	248	1280 x 1024
	V(Lines)	+		60.02	1066	1024	1	3	38	
13	H(Pixels)	+	135.0	79.976	1688	1280	16	144	248	1280 x 1024
	V(Lines)	+		75.035	1066	1024	1	3	38	

DISASSEMBLY-Set

1

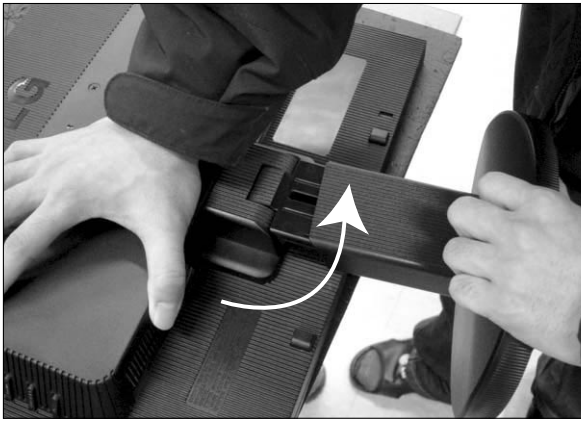

Disassembly Like a picture.

2

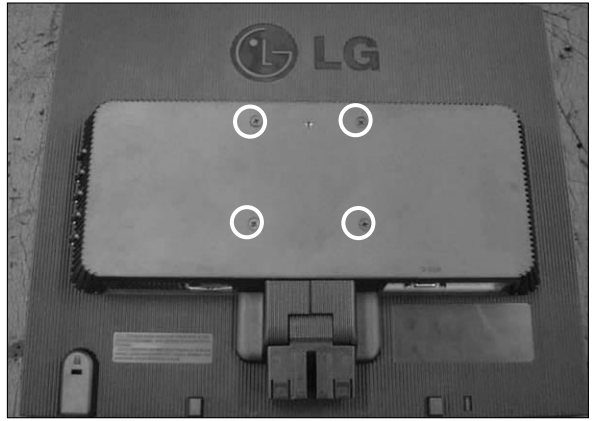

Remove the screws.

3-1



1. Pull the front cover upward.
2. Then, let the all latches are separated.(#3-1~3-2)
3. Put the front face down.

3-2



4

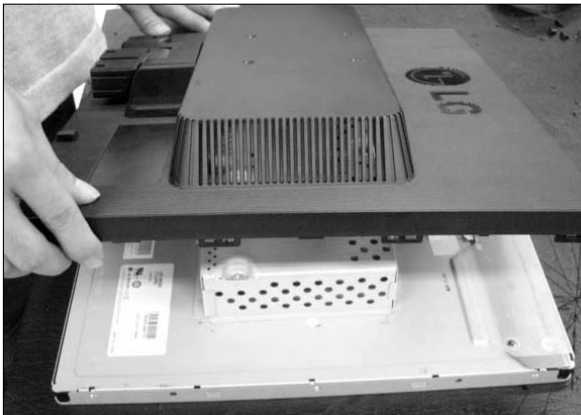

Disassemble back cover.

DISASSEMBLY-Stand

1

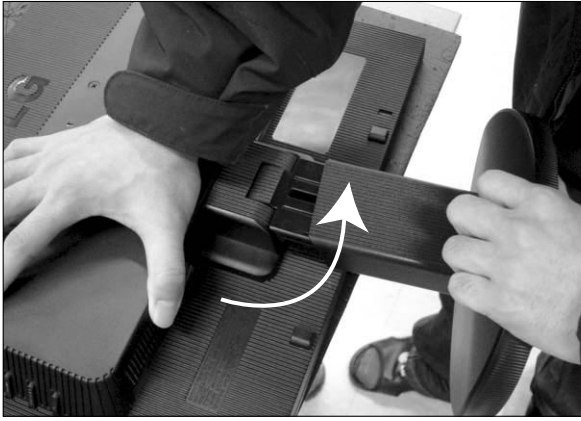

1. In assembly state, Twist Stand Body to Right side.

2

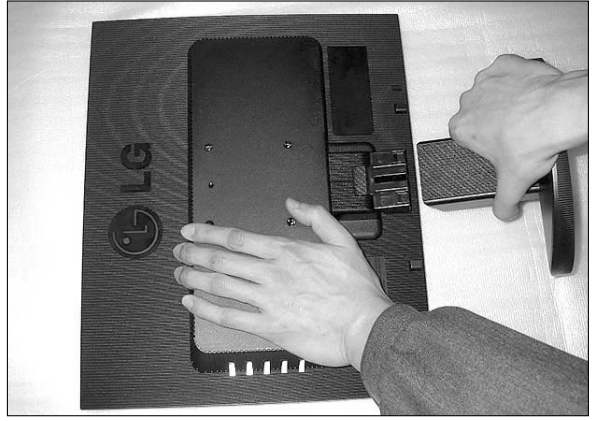

2. Pull Stand and Separate Stand from Monitor set.

3-1

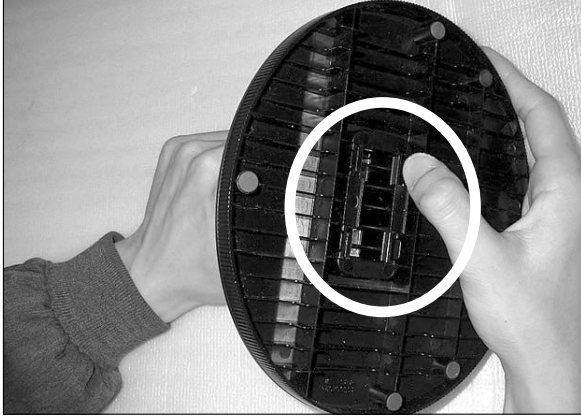

3. Push the four latches on the bottom to the outside and Separate Stand Body & Base. (Reference the #3-2)

3-2

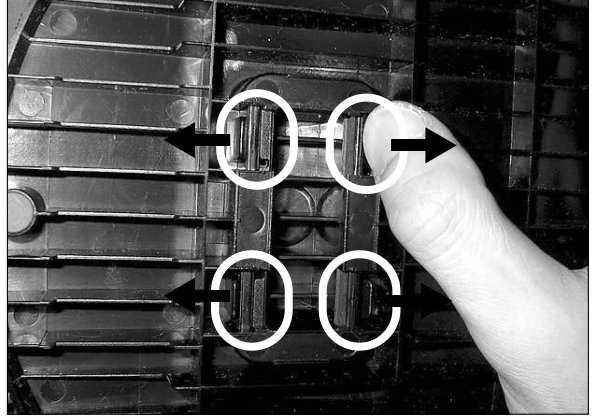

3-3

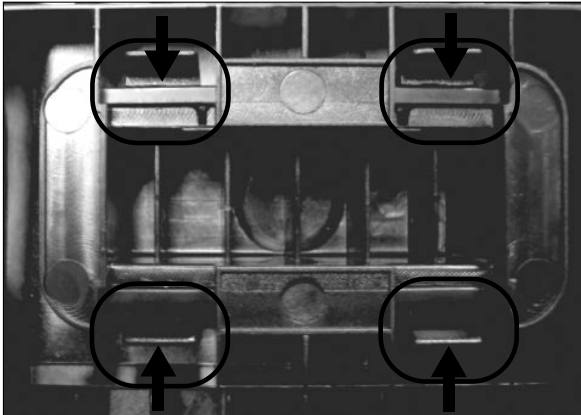

After finished repair, necessarily push 4ea Latches to inside for restoration.

4

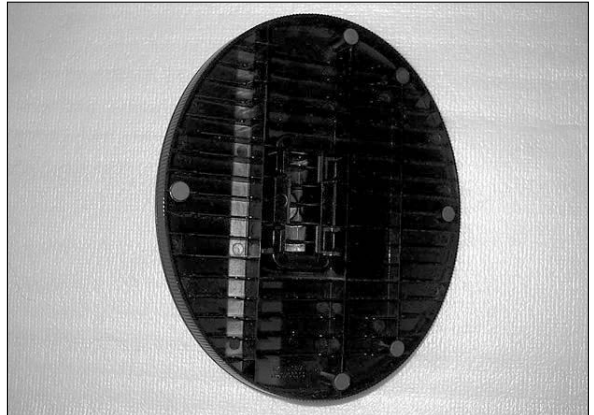

BLOCK DIAGRAM

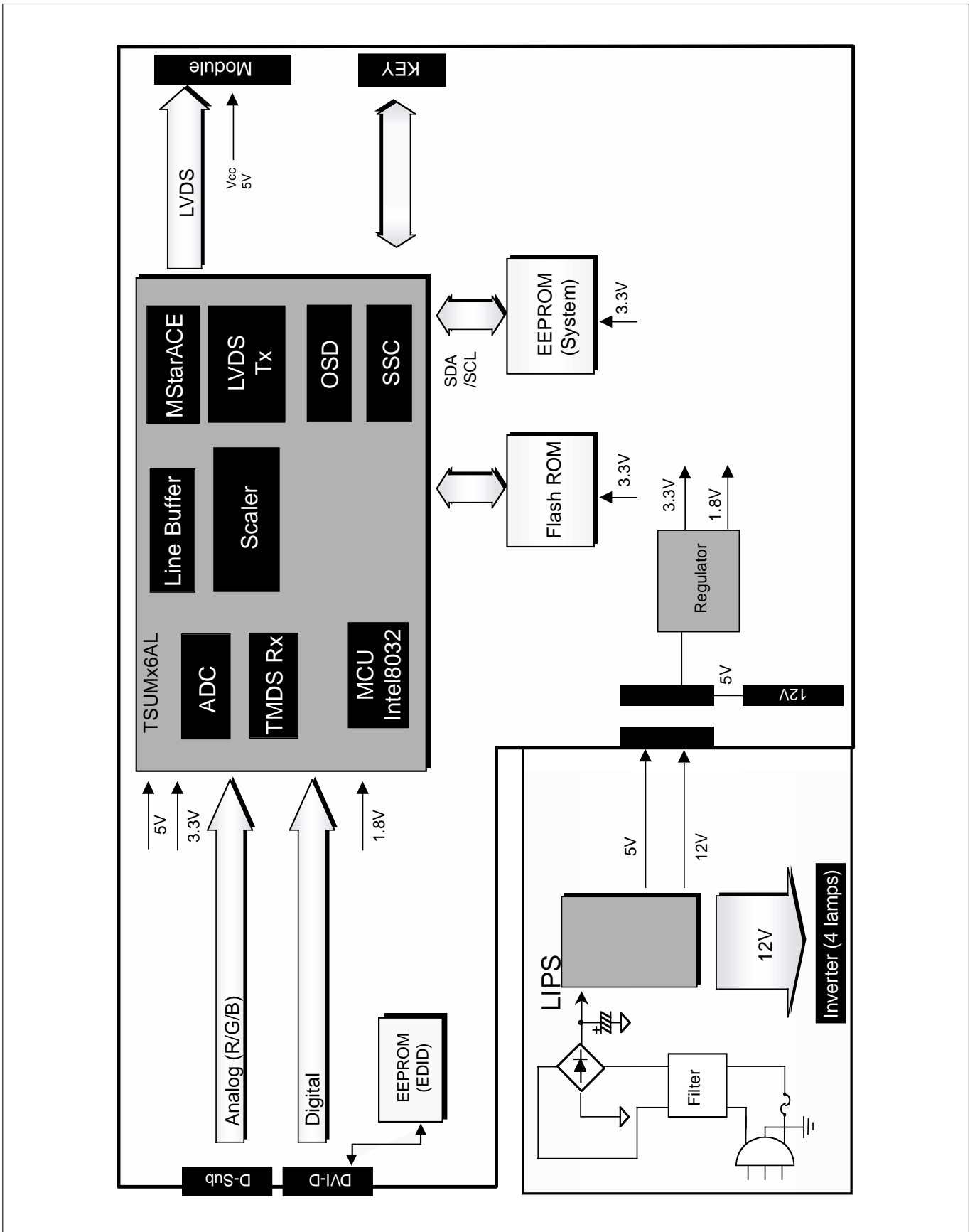

BLOCK DIAGRAM-POWER

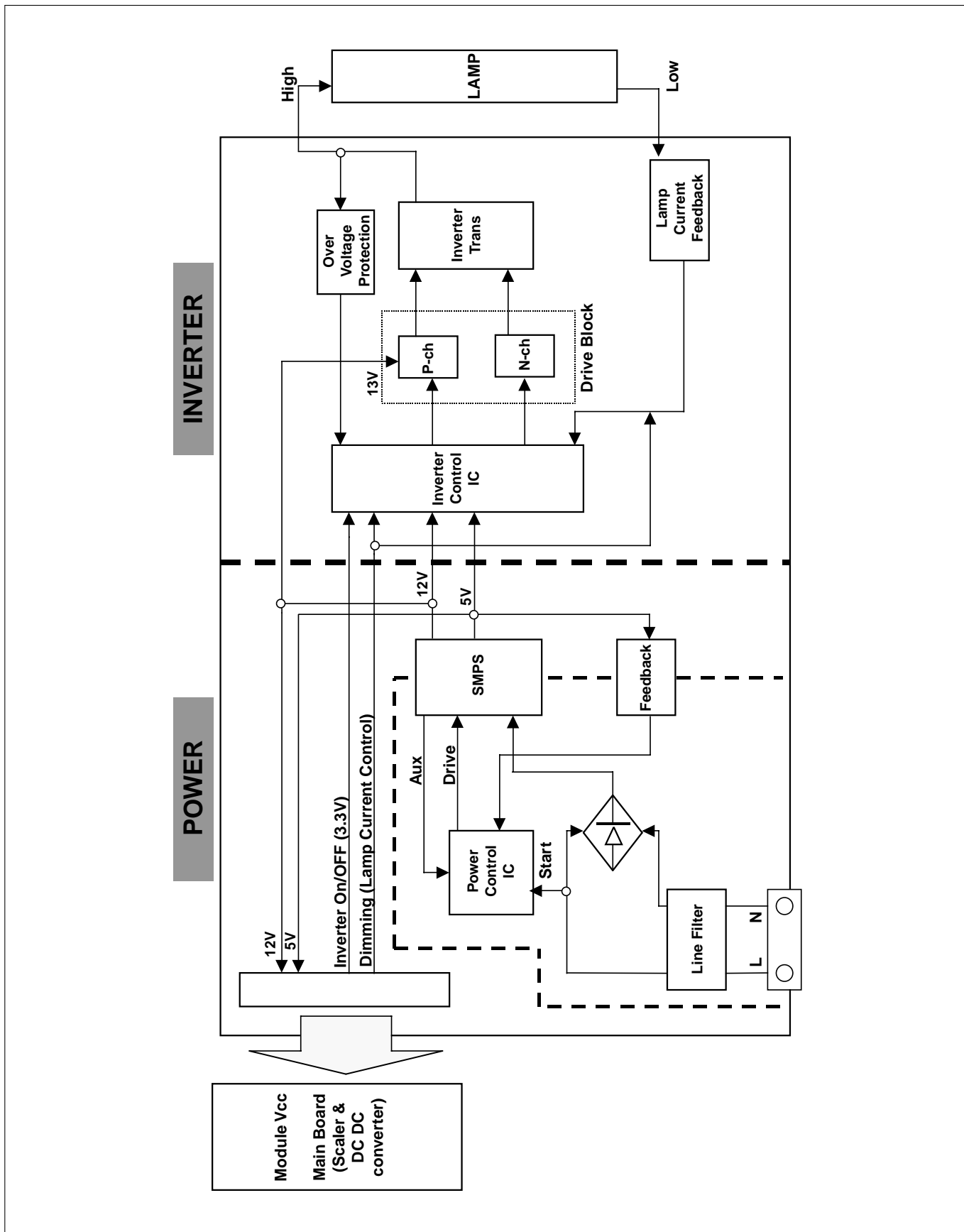

DESCRIPTION OF BLOCK DIAGRAM

1. Video Controller Part.

This part amplifies the level of video signal for the digital conversion and converts from the analog video signal to the digital video signal using a pixel clock.

The pixel clock for each mode is generated by the PLL.

The range of the pixel clock is from 25MHz to 135MHz.

This part consists of the Scaler, ADC convertor, TMDS receiver and LVDS transmitter.

The Scaler gets the video signal converted analog to digital, interpolates input to 1280 X 1024 resolution signal and outputs 8-bit R, G, B signal to transmitter.

2. Power Part.

This part consists of the one 3.3V, and one 1.8V regulators to convert power which is provided 5V in Power board.

12V is provided for inverter, 5V is provided for LCD panel.

Also, 5V is converted 3.3V and 1.8V by regulator. Converted power is provided for IC in the main board.

The inverter converts from DC12V to AC 700Vrms and operates back-light lamps of module.

3. MICOM Part.

This part is include video controller part. And this part consists of EEPROM IC which stores control data, Reset IC and the Micom.

The Micom distinguishes polarity and frequency of the H/V sync are supplied from signal cable.

The controlled data of each modes is stored in EEPROM.

LIPS Board Block Diagram

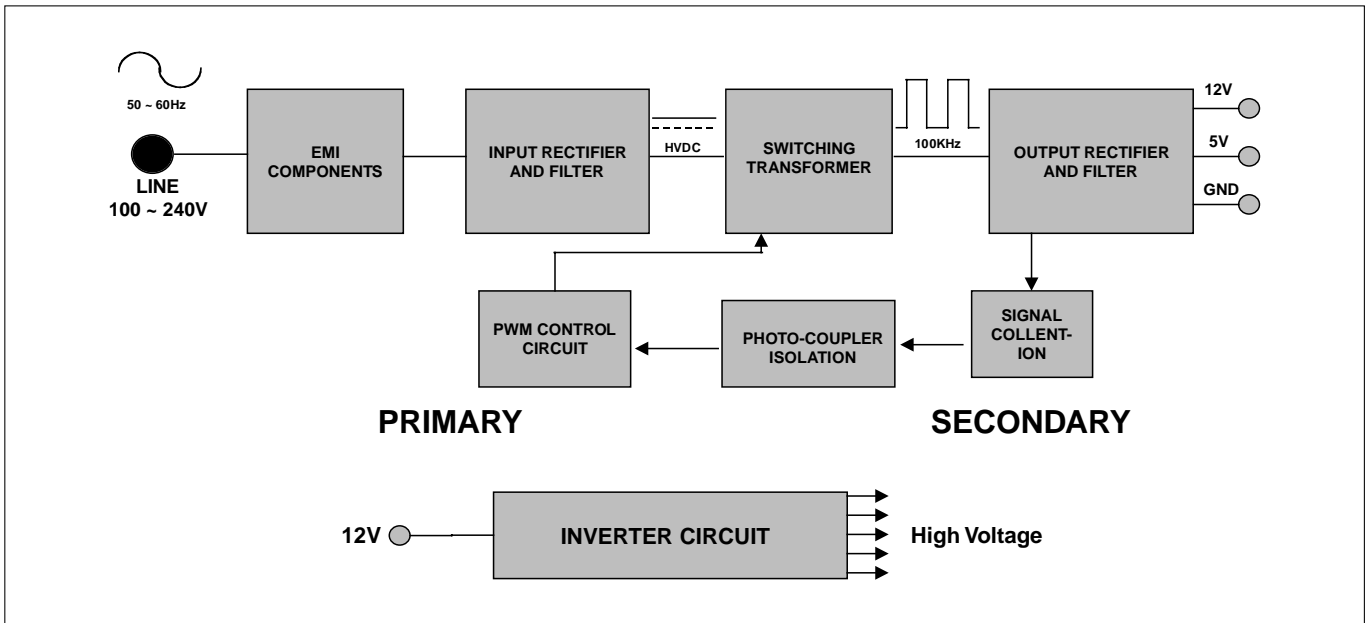

Operation description_LIPS

1. EMI components.

This part contains of EMI components to comply with global marketing EMI standards like FCC,VCCI CISPR, the circuit included a line-filter, across line capacitor and of course the primary protection fuse.

2. Input rectifier and filter.

This part function is for transfer the input AC voltage to a DC voltage through a bridge rectifier and a bulk capacitor.

3. Energy Transfer.

This part function is for transfer the primary energy to secondary through a power transformer.

4. Output rectifier and filter.

This part function is to make a pulse width modulation control and to provide the driver signal to power switch, to adjust the duty cycle during different AC input and output loading condition to achieve the dc output stabilized, and also the over power protection is also monitor by this part.

5. Photo-Coupler isolation.

This part function is to feed back the DC output changing status through a photo transistor to primary controller to achieve the stabilized DC output voltage.

6. Signal collection.

This part function is to collect the any change from the DC output and feed back to the primary through photo transistor.

ADJUSTMENT

Windows EDID V1.0 User Manual

Operating System: MS Windows 98, 2000, XP
 Port Setup: Windows 98 => Don't need setup
 Windows 2000, XP => Need to Port Setup.

This program is available to LCD Monitor only.

2. EDID Read & Write
 - 1) Run WinEDID.exe

1. Port Setup

- a) Copy "UserPort.sys" file to
 "c:\WINNT\system32\drivers" folder
- b) Run Userport.exe

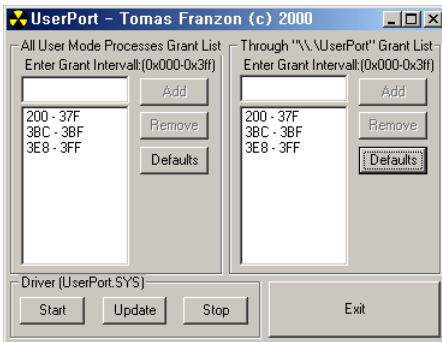

- c) Remove all default number
- d) Add 300-3FF

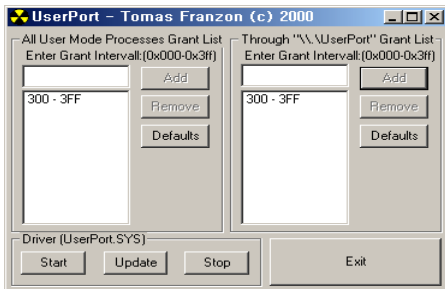

- e) Click Start button.
- f) Click Exit button.

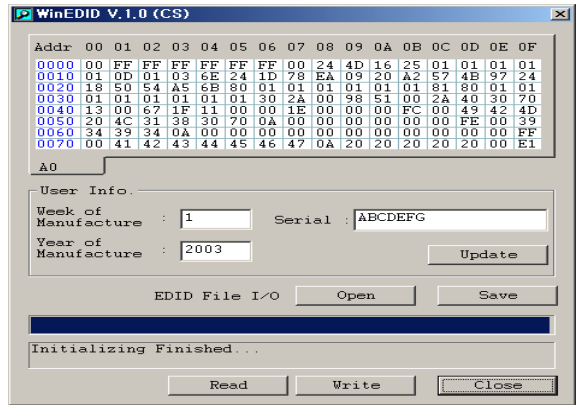

- 2) Edit Week of Manufacture, Year of Manufacture, Serial Number
 - a) Input User Info Data
 - b) Click "Update" button
 - c) Click "Write" button

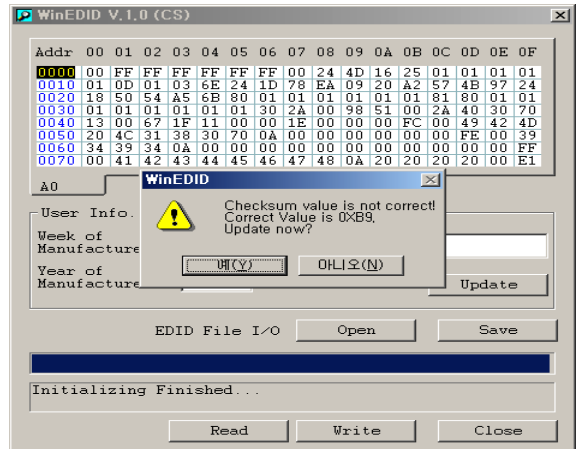

TROUBLESHOOTING GUIDE

1. NO POWER

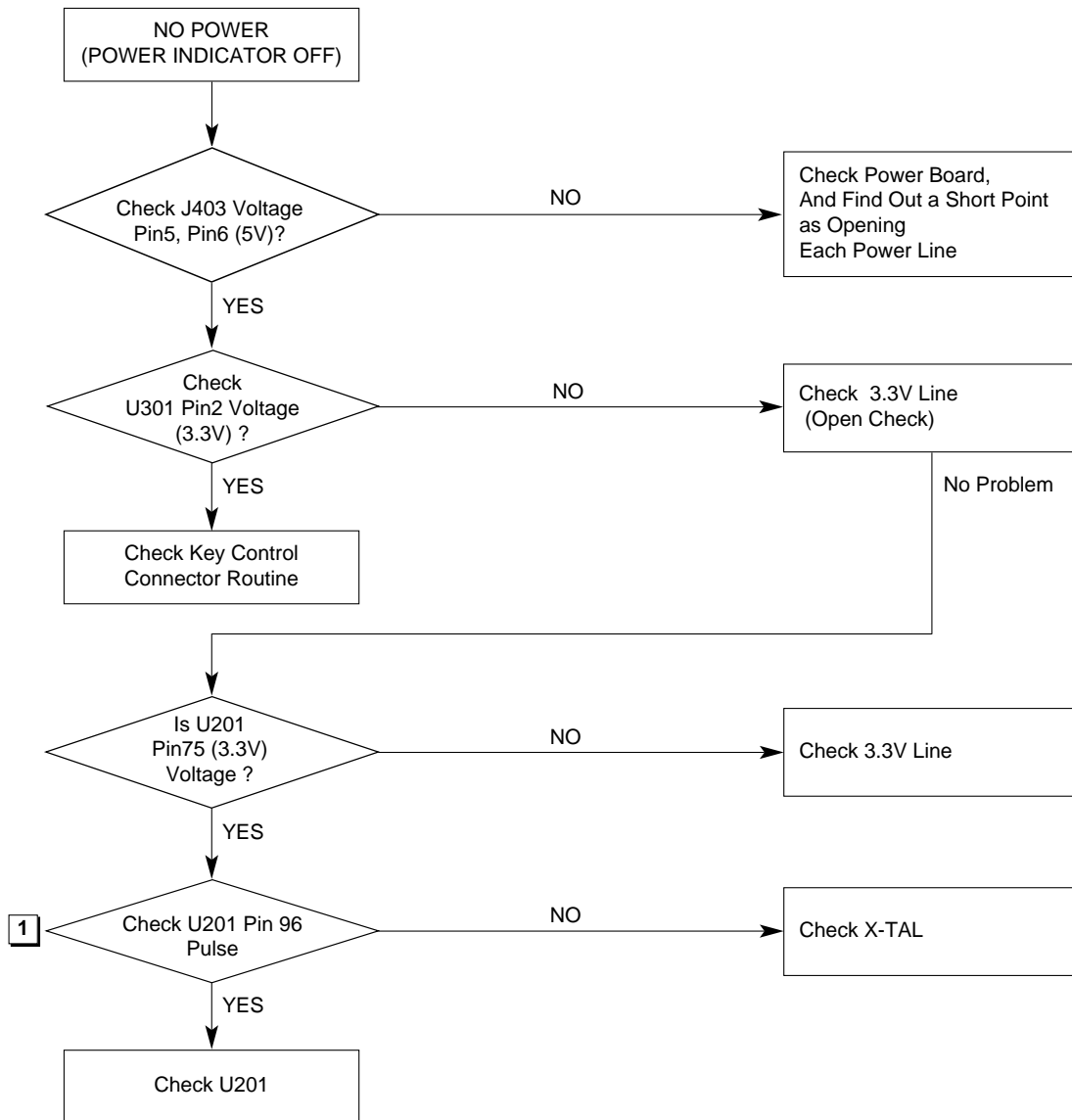

Waveforms

1 U201-#96

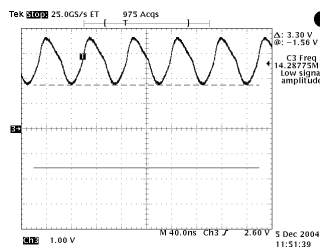

2. NO RASTER (OSD IS NOT DISPLAYED) – LIPS

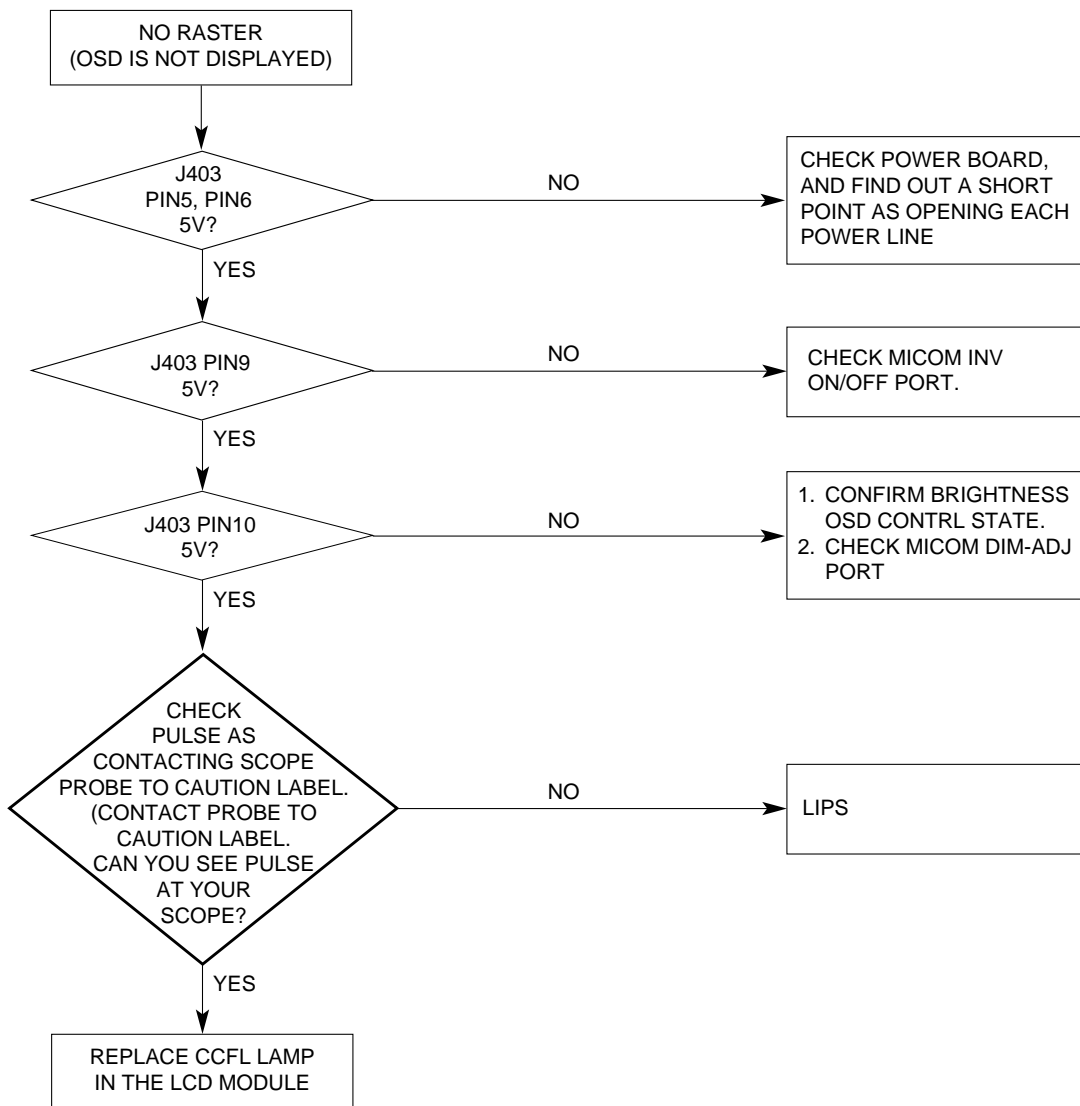

3. NO RASTER (OSD IS NOT DISPLAYED) – MSTAR

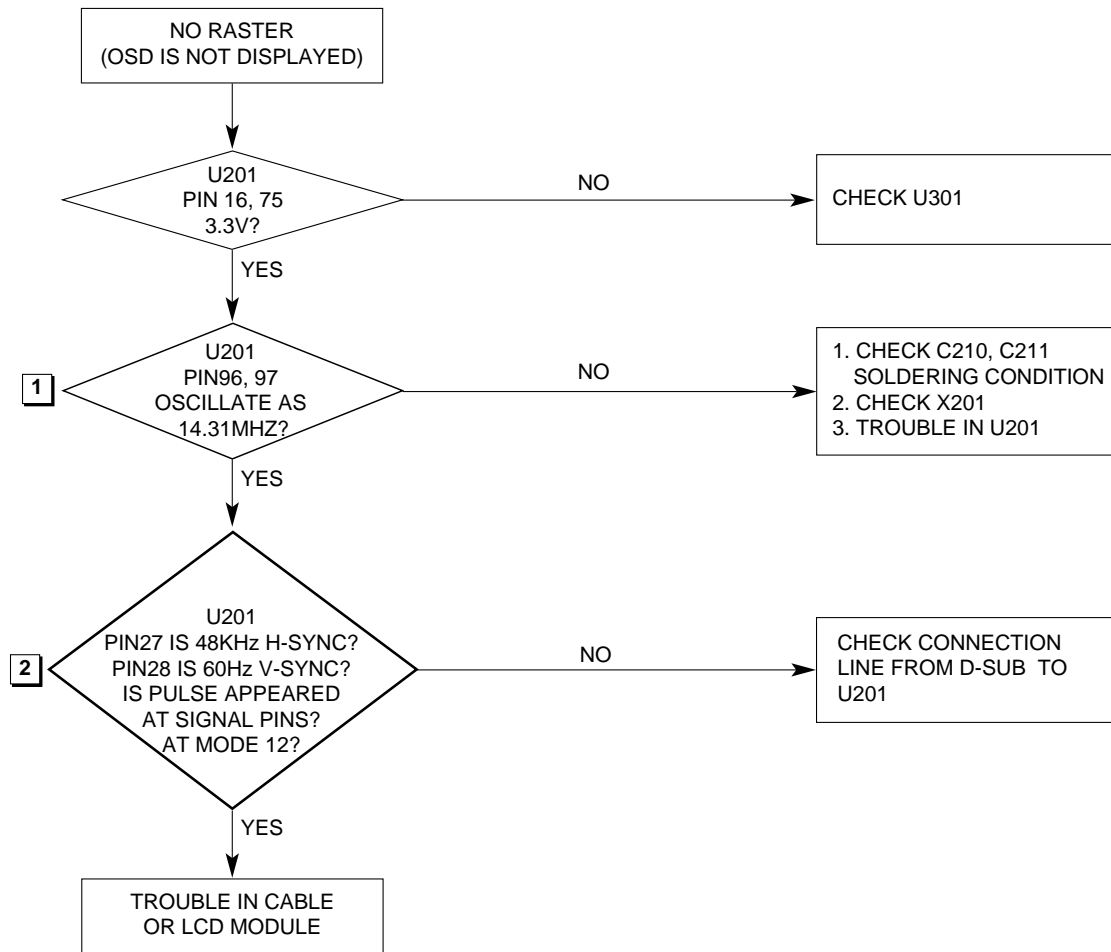

Waveforms

1 U201-#96, 97

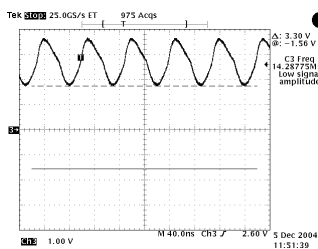

2 U201-#27 H-SYNC

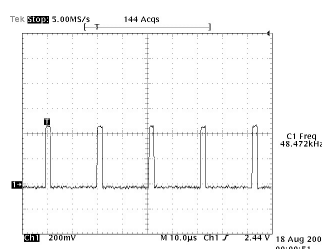

2 U201-#28 V-SYNC

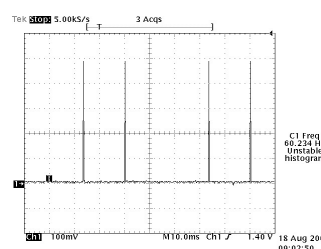

4. TROUBLE IN DPM

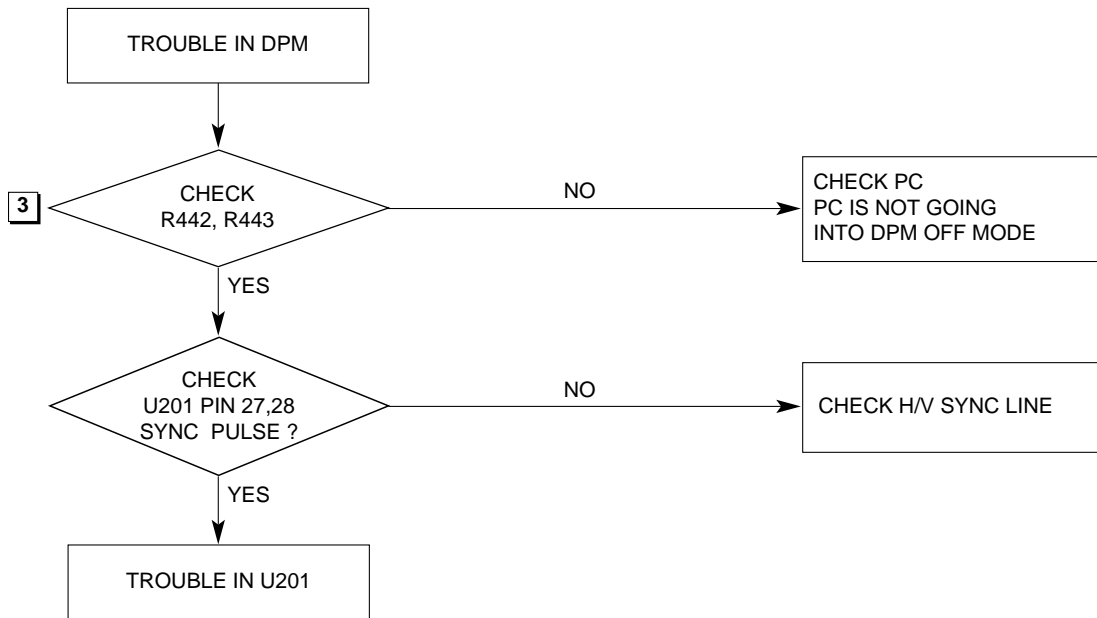

Waveforms

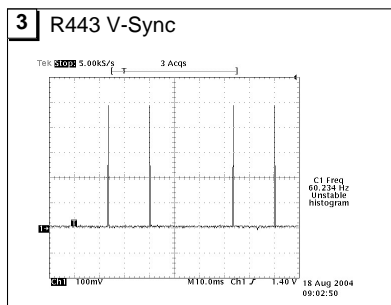
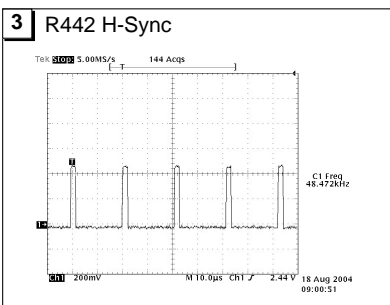

5. POWER

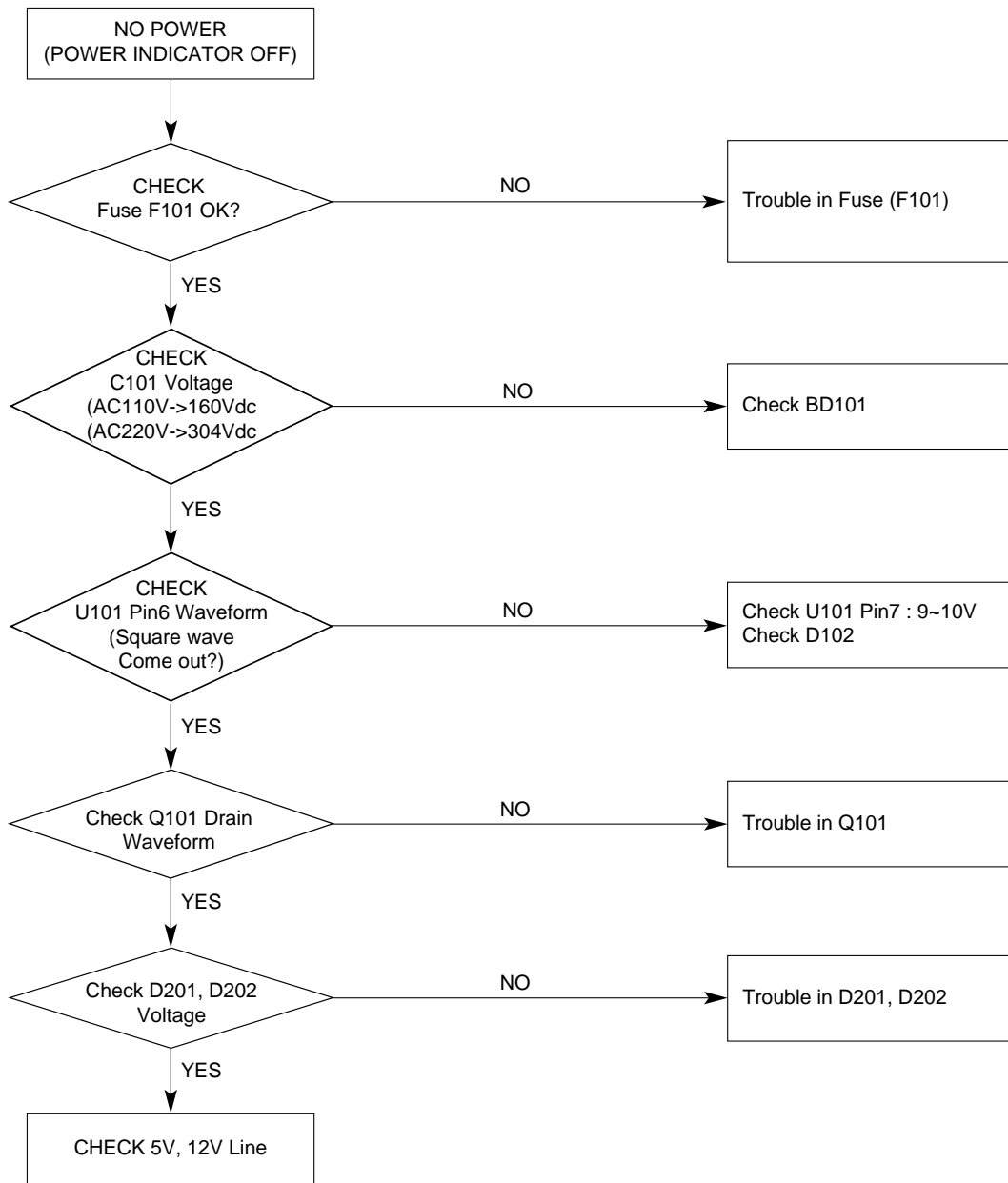

6. Raster

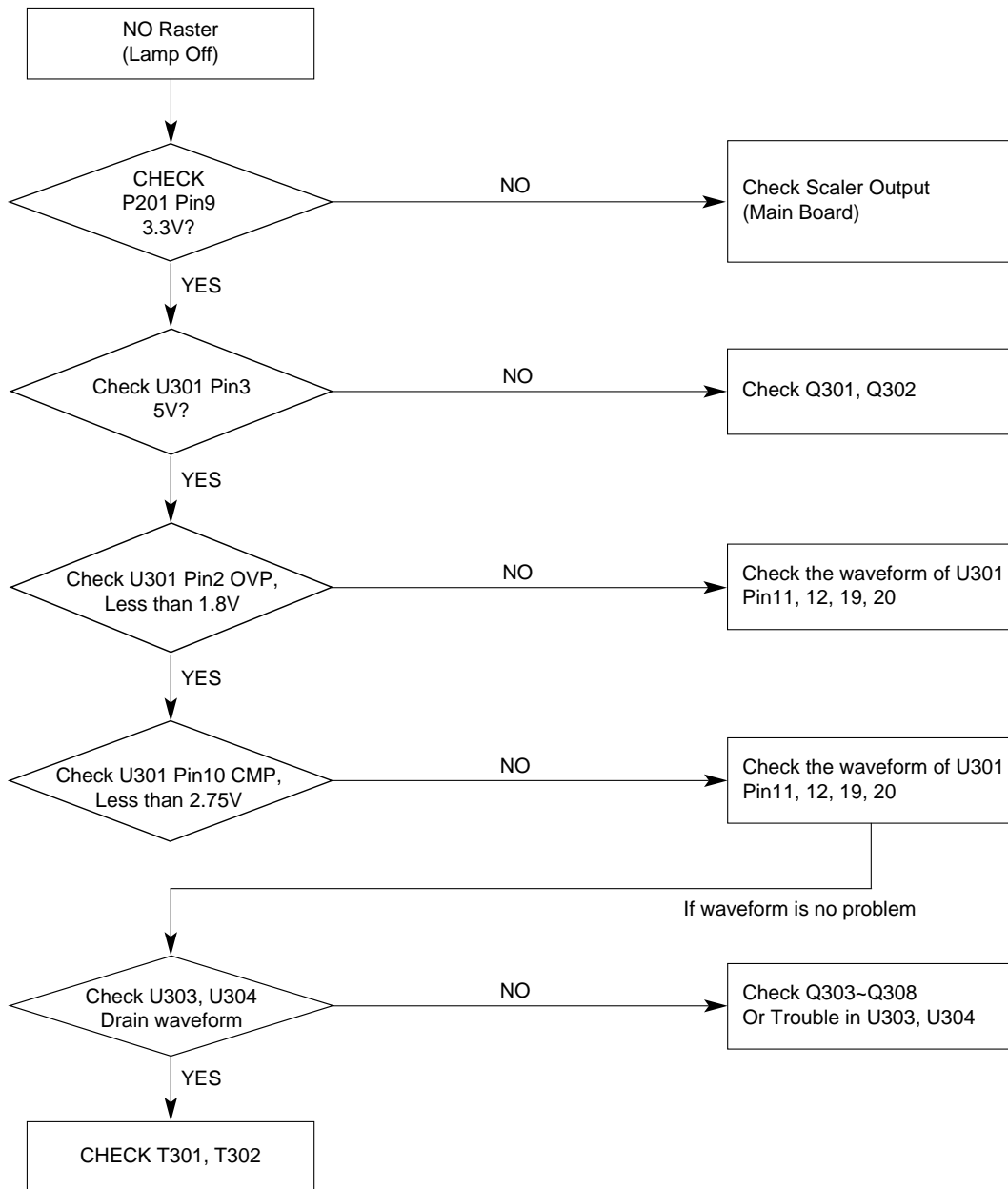

WIRING DIAGRAM

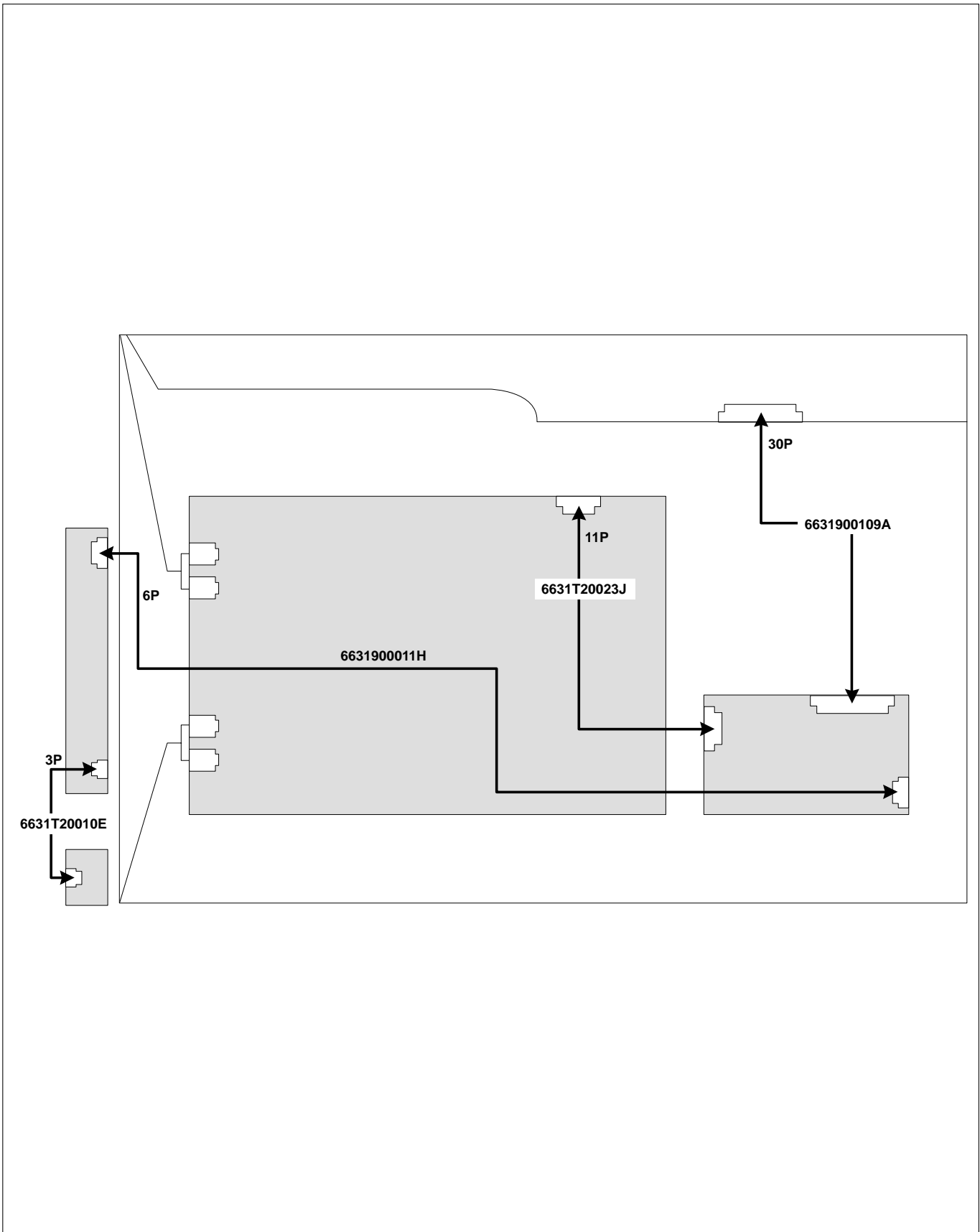

EXPLODED VIEW

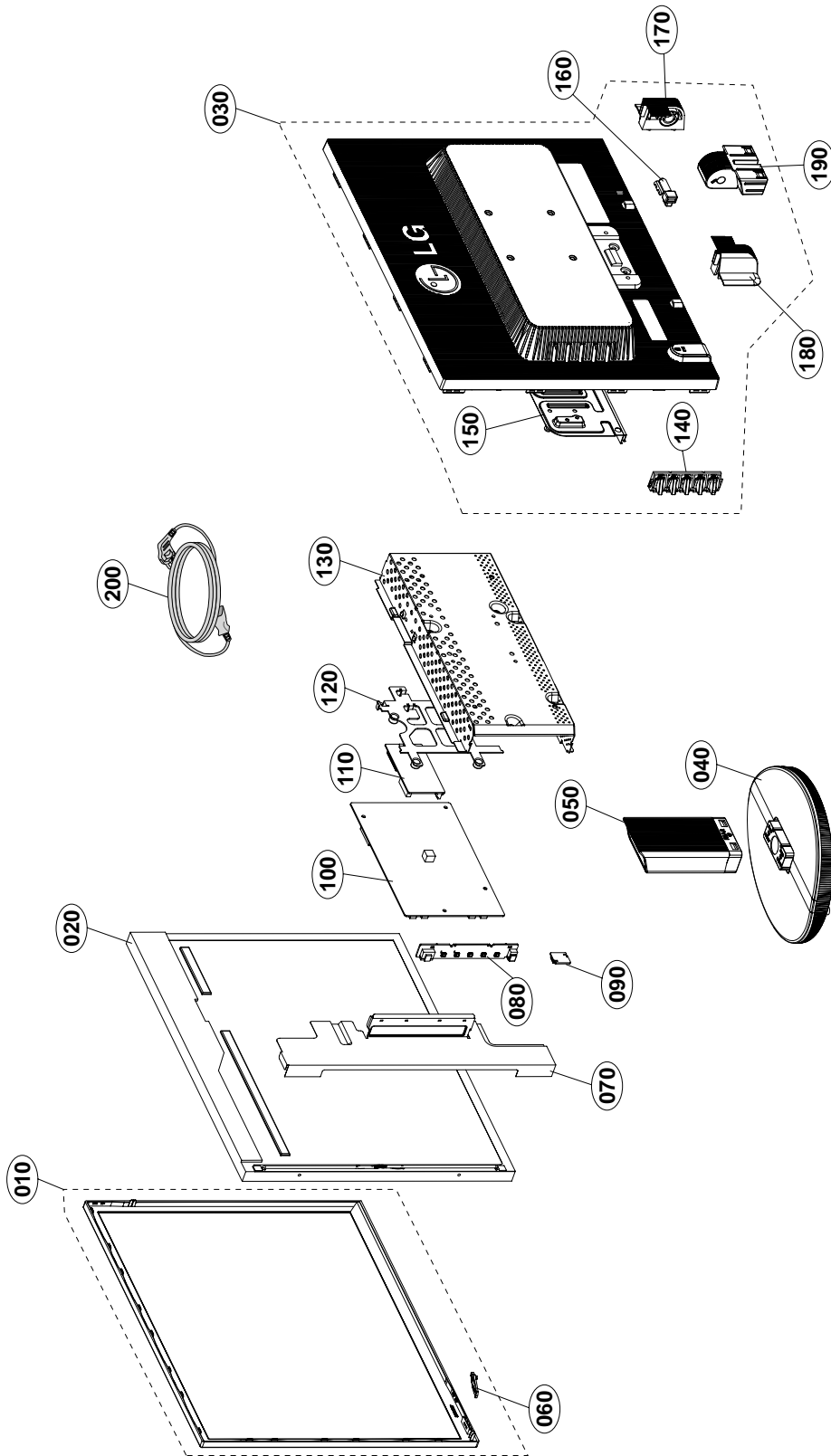

EXPLODED VIEW PARTS LIST

* Note: Safety mark 

Ref. No.	Part No.	Description
010	 30919C0018L	CABINET ASSEMBLY, L1752T BRAND 30909C0006 CABINET ASSY+ SILVER +PCABS+DUAL
	30919C0018M	CABINET ASSEMBLY, L1752T BRAND 30909C0006 CABINET ASSY+ BLACK +PCABS+DUAL
	30919C0019J	CABINET ASSEMBLY, L1952T BRAND 30909C0007 CABINET ASSY- SILVER -DUAL+PC ABS
	30919C0019K	CABINET ASSEMBLY, L1952T BRAND 30909C0007 CABINET ASSY- BLACK -DUAL+PC ABS
020	 6304FLP278A	LCD(LIQUID CRYSTAL DISPLAY), LM170E01-TLB1 LG PHILIPS TFT COLOR P5,645CH,300NITS,8MS,700/1,LPL NJ/KUMI,PB FREE,EGI,OKI S D-IC,EGI,
	6304FLP312A	LCD(LIQUID CRYSTAL DISPLAY), LM190E03-TLB7 LG PHILIPS TFT COLOR P4,645CH,300NITS,TN,8MS,LPL KUMI,PB FREE,EGI,NEC S D-IC,SXGA,LVDS
	or 6304FLP337A	LCD(LIQUID CRYSTAL DISPLAY), LM190E03-TLBB LG PHILIPS TFT COLOR DOT FREE OF LM190E03-TLB7,P4,645CH,300NITS,TN,8MS,LPL KUMI,PB FREE
	6304FLP310A	LCD(LIQUID CRYSTAL DISPLAY), LM190E03-TLB5 LG PHILIPS TFT COLOR P4,645CH,300NITS,TN,8MS,LPL KUMI,PB FREE,EGI,OKI S D-IC,SXGA,LVDS
030	 3809900177N	BACK COVER ASSEMBLY, L1752T NON BACK COVER ASSY PC+ABS MODULE-LPL-DUAL
	3809900178K	BACK COVER ASSEMBLY, L1952T NON BACK COVER MODULE-LPL-DUAL
040	 3043900041A	TILT SWIVEL ASSEMBLY, LX52 35509K0241 STAND BASE ASSY
050	35509K0245A	COVER, L1752S STAND BODY .
	35509K0246A	COVER, L1952S STAND BODY .
060	3520900038A	INDICATOR, LED&PRE AMP LX52 PMMA NON LED LENS
070	49509K0266A	METAL, SHIELD LX52 LAMP- L1752T
	49509K0267A	METAL, SHIELD L1952 LAMP
080	68719STA24C	PWB(PCB) ASSEMBLY,SUB, SUB T.T LM57A LX52 KXRQPT NT CKD CONTROLL- SILVER
	68719ST086A	PWB(PCB) ASSEMBLY,SUB, SUB T.T LM56A L1752/L1952BFQ .KXRQPT CONTROL TOTAL NT CKD- BLACK
090	0DLLT0089AA	LED, LITEON LTL-1BEDJ-0C2 TP GREEN/YELLOW 19MCD
100	 68719PT298A	PWB(PCB) ASSEMBLY,POWER, POWER T.T LM57A L1752S KNRDQPT TOTAL
	or 6709900027A	SMPS,AC/DC, AIVP 100.0TO240.0 40W 50TO60HZ
110	33139L7033C	MAIN TOTAL ASSEMBLY, L1752T-BFQ .KXRQPT NT CKD TSUM56AWL BRAND LM57B- SILVER
	33139L7030A	MAIN TOTAL ASSEMBLY, L1752T-BFQ .KXRQPT NT CKD TSUM56AWL BRAND LM56A- BLACK
	33139L9041C	MAIN TOTAL ASSEMBLY, L1952T-BFQ .KXRQPT NT CKD BRAND LM57B TSUM56AWL- SILVER
	33139L9008A	MAIN TOTAL ASSEMBLY, L1952T-BFQ .KXRQPT NT CKD TSUM56AWL BRAND 14-LANGUAGE LM57B- BLACK
120	35509K0247A	COVER, LX52 PIECE COVER VESA
130	49509S0034B	METAL, SHIELD LX52 REAR SHIELD-DUAL
140	4940900022B	KNOB, MAIN 5KEY LX52 TACK KNOB ADD SOURCE PRINTING
150	49509K0262A	METAL, SUPPORT L1752 BRACKET
	49509K0263A	METAL, SUPPORT L1952S BRACKET
160	49519K0137A	METAL ASSEMBLY, STAND HINGE ASSY 17 INCH
170	35509K0242A	COVER, LX52 HINGE R
180	35509K0243A	COVER, LX52 HINGE L
190	35509K0244A	COVER, LX52 HINGE COVER BODY
200	64109UP002A	POWER CORD, DTII-3P-11+DTII-3P-04 HONGCHANG UL/CSA 1870MM PLUG SILVER
	6410TUW008A	POWER CORD, LP31+LS13 LONGWELL UL/CSA 1870MM WALL CD/PB FREE BLACK-L1752T
	6410TUW008B	POWER CORD, LP31+LS13 LONGWELL UL/CSA 1870MM WALL CD/PB FREE 85964 BLACK-L1952T

REPLACEMENT PARTS LIST

CAUTION: BEFORE REPLACING ANY OF THESE COMPONENTS,
READ CAREFULLY THE **SAFETY PRECAUTIONS** IN THIS MANUAL.
MAIN BOARD AND POWER BOARD PARTS ARE DIFFERENT.

* NOTE : **S** SAFETY Mark
AL ALTERNATIVE PARTS

DATE: 2006. 01. 26.			
*S	*AL	LOC. NO.	PART NO. DESCRIPTION / SPECIFICATION
MAIN BOARD			
CAPACITORS			
		C101	0CZZ9ST017A AL EL CAPACITOR 100UF 450V 2
		C102	0CK22201510 2200PF D 1KV 10% B(Y5P) R
		C103	0CZZ9ST014A AL EL CAPACITOR 33UF 50V 20%
		C104	0CH5271K416 270PF 2012 50V 5% NP0 R/TP
		C105	0CZZ9ST013A AL EL CAPACITOR 0.47UF 50V 2
		C106	0CK222DK4DA 2200PF 2012 50V 5% COG R/TP
		C107	0CK1040K945 "0.1UF D 50V 80%,-20% F(Y5V)"
		C201	0CK104CK56A 0.1UF 1608 50V 10% R/TP X7R
		C201	0CKZTTA002E EKR3A102K09FK5 SAMWHA 1KV 10
		C202	0CZZ9ST021A AL EL CAPACITOR 1000UF 25V 2
		C203	0CK473CH56A 0.047UF 1608 25V 10% R/TP X7
		C203	0CZZ9ST020A AL EL CAPACITOR 680UF 25V 20
		C204	0CK473CH56A 0.047UF 1608 25V 10% R/TP X7
		C204	0CZZ9ST018A AL EL CAPACITOR 1000UF 16V 2
		C205	0CK473CH56A 0.047UF 1608 25V 10% R/TP X7
		C205	0CZZ9ST018A AL EL CAPACITOR 1000UF 16V 2
		C206	0CK473CH56A 0.047UF 1608 25V 10% R/TP X7
		C206	0CZZ9ST021A AL EL CAPACITOR 1000UF 25V 2
		C207	0CC102CK41A 1000PF 1608 50V 5% R/TP NP0
		C207	0CZZ9ST019A AL EL CAPACITOR 470UF 25V 20
		C208	0CK473CH56A 0.047UF 1608 25V 10% R/TP X7
		C208	0CKZTTA002B 330PF 1KV K R TP5.0 TAPING .
		C209	0CK473CH56A 0.047UF 1608 25V 10% R/TP X7
		C210	0CC220CK41A 22PF 1608 50V 5% R/TP NP0
		C210	0CH3104K566 0.1UF 50V 10% X7R 2012 R/TP
		C211	0CC220CK41A 22PF 1608 50V 5% R/TP NP0
		C213	0CK104CK56A 0.1UF 1608 50V 10% R/TP X7R
		C215	0CE106CF638 "10UF SHL,SD 16V M FM5 TP 5"
		C216	0CK104CK56A 0.1UF 1608 50V 10% R/TP X7R
		C217	0CK104CK56A 0.1UF 1608 50V 10% R/TP X7R
		C218	0CK104CK56A 0.1UF 1608 50V 10% R/TP X7R
		C219	0CK104CK56A 0.1UF 1608 50V 10% R/TP X7R
		C220	0CK104CK56A 0.1UF 1608 50V 10% R/TP X7R
		C221	0CK104CK56A 0.1UF 1608 50V 10% R/TP X7R
		C222	0CK104CK56A 0.1UF 1608 50V 10% R/TP X7R
		C223	0CK104CK56A 0.1UF 1608 50V 10% R/TP X7R
		C224	0CK104CK56A 0.1UF 1608 50V 10% R/TP X7R
		C225	0CK104CK56A 0.1UF 1608 50V 10% R/TP X7R
		C226	0CK104CK56A 0.1UF 1608 50V 10% R/TP X7R
		C227	0CK104CK56A 0.1UF 1608 50V 10% R/TP X7R
		C228	0CK104CK56A 0.1UF 1608 50V 10% R/TP X7R
		C229	0CK104CK56A 0.1UF 1608 50V 10% R/TP X7R
		C230	0CK104CK56A 0.1UF 1608 50V 10% R/TP X7R
		C301	0CE107EF610 "100UF KMG,RD 16V 20% FL BULK"
		C301	0CZZTCT006D C3216X7R1E225M TDK 25V 2.2UF
		C302	0CK103CK51A 0.01UF 1608 50V 10% R/TP B(Y
		C303	0CK103CK51A 0.01UF 1608 50V 10% R/TP B(Y
		C303	0CZZTCT006D C3216X7R1E225M TDK 25V 2.2UF
		C304	0CK105CD56A 1UF 1608 10V 10% R/TP X7R
		C304	0CZZTCT006D C3216X7R1E225M TDK 25V 2.2UF
		C305	0CE107EF610 "100UF KMG,RD 16V 20% FL BULK"
		C305	0CZZTCT006D C3216X7R1E225M TDK 25V 2.2UF

DATE: 2006. 01. 26.			
*S	*AL	LOC. NO.	PART NO. DESCRIPTION / SPECIFICATION
		C306	0CE107EF610 "100UF KMG,RD 16V 20% FL BULK"
		C306	0CK224DH56A 0.22UF 2012 25V 10% R/TP X7R
		C307	0CH3104K566 0.1UF 50V 10% X7R 2012 R/TP
		C308	0CK105DH56A 1UF 2012 25V 10% X7R R/TP
		C309	0CK224DH56A 0.22UF 2012 25V 10% R/TP X7R
		C310	0CK105DH56A 1UF 2012 25V 10% X7R R/TP
		C313	0CH2393K516 39000PF 50V 10% B(Y5P) 2012
		C314	0CK152DK51A 1500PF 2012 50V 10% B(Y5P) R
		C315	0CH3103K516 10000PF 50V 10% B(Y5P) 2012
		C317	0CH5221K416 220PF 50V 5% NP0 2012 R/TP
		C320	0CZZTCT006D C3216X7R1E225M TDK 25V 2.2UF
		C402	0CK22201510 2200PF D 1KV 10% B(Y5P) R
		C403	0CZZ9ST028A CERAMIC DISK 10PF 6KV 5% TR
		C404	0CH2153K516 15000PF 50V 10% B(Y5P) 2012
		C405	0CK22201510 2200PF D 1KV 10% B(Y5P) R
		C406	0CZZ9ST028A CERAMIC DISK 10PF 6KV 5% TR
		C407	0CH2153K516 15000PF 50V 10% B(Y5P) 2012
		C408	0CK103CK51A 0.01UF 1608 50V 10% R/TP B(Y
		C409	0CK103CK51A 0.01UF 1608 50V 10% R/TP B(Y
		C409	0CK22201510 2200PF D 1KV 10% B(Y5P) R
		C410	0CK104CK56A 0.1UF 1608 50V 10% R/TP X7R
		C410	0CZZ9ST028A CERAMIC DISK 10PF 6KV 5% TR
		C411	0CK105CD56A 1UF 1608 10V 10% R/TP X7R
		C411	0CH2153K516 15000PF 50V 10% B(Y5P) 2012
		C412	0CC101CK41A 100PF 1608 50V 5% R/TP NP0
		C412	0CK22201510 2200PF D 1KV 10% B(Y5P) R
		C413	0CC101CK41A 100PF 1608 50V 5% R/TP NP0
		C413	0CZZ9ST028A CERAMIC DISK 10PF 6KV 5% TR
		C414	0CC101CK41A 100PF 1608 50V 5% R/TP NP0
		C414	0CH2153K516 15000PF 50V 10% B(Y5P) 2012
		C415	0CK104CK56A 0.1UF 1608 50V 10% R/TP X7R
		C415	0CH2222K516 2200PF 50V 10% B(Y5P) 2012 R
		C416	0CK104CK56A 0.1UF 1608 50V 10% R/TP X7R
		C417	0CK104CK56A 0.1UF 1608 50V 10% R/TP X7R
		C417	0CH2222K516 2200PF 50V 10% B(Y5P) 2012 R
		C418	0CK104CK56A 0.1UF 1608 50V 10% R/TP X7R
		C418	0CH2222K516 2200PF 50V 10% B(Y5P) 2012 R
		C419	0CK104CK56A 0.1UF 1608 50V 10% R/TP X7R
		C419	0CH2222K516 2200PF 50V 10% B(Y5P) 2012 R
		C420	0CK104CK56A 0.1UF 1608 50V 10% R/TP X7R
		C421	0CK104CK56A 0.1UF 1608 50V 10% R/TP X7R
		C422	0CK104CK56A 0.1UF 1608 50V 10% R/TP X7R
		C423	0CK104CK56A 0.1UF 1608 50V 10% R/TP X7R
		C424	0CK103CK51A 0.01UF 1608 50V 10% R/TP B(Y
		C425	0CC680CK41A 68PF 1608 50V 5% R/TP NP0
		C426	0CC680CK41A 68PF 1608 50V 5% R/TP NP0
		C427	0CC680CK41A 68PF 1608 50V 5% R/TP NP0
		C428	0CC680CK41A 68PF 1608 50V 5% R/TP NP0
		CX101	0CZZ9ST025A FILM CAPACITOR 0.47UF 275V 1
		CY101	0CZZ9ST024A "Y CAPACITOR 100PF 250V 10%,-"
		CY102	0CZZ9ST024A "Y CAPACITOR 100PF 250V 10%,-"
		CY104	0CZZ9ST023A "Y CAPACITOR 4700PF 250V 20%,-"

DATE: 2006. 01. 26.				
*S	*AL	LOC. NO.	PART NO.	DESCRIPTION / SPECIFICATION
DIODEs				
		BD101	0DRTW00121A	D2SB60-1121 TIWAN SEMI ST GB
		D101	0DRGF00354A	UF4007(GPP) GULF TAPING52 DO
		D102	0DRGF00354A	UF4007(GPP) GULF TAPING52 DO
		D103	0DSGF00019A	1N4148 GULF TP DO35 100V 0.1
		D201	0DRNH00140A	FCH10U15 NIHON INTER BULK TO
		D202	0DRNH00130A	FCH10U10 NIHON INTER BULK TO
		D306	0DSGD00048A	MM4148 GRANDE REEL TAPING LL
		D401	0SDSI00038A	"BAV99-(F),LF DIODES R/TP SOT"
		D402	0SDSI00038A	"BAV99-(F),LF DIODES R/TP SOT"
		D403	0SDSI00038A	"BAV99-(F),LF DIODES R/TP SOT"
		D404	0SDSI00038A	"BAV99-(F),LF DIODES R/TP SOT"
		D405	0DS226009AA	KDS226 TP KEC - 80V -- 4NSE
		D405	0SDSI00038A	"BAV99-(F),LF DIODES R/TP SOT"
		D406	0DS226009AA	KDS226 TP KEC - 80V -- 4NSE
		D406	0SDSI00038A	"BAV99-(F),LF DIODES R/TP SOT"
		D407	0DS226009AA	KDS226 TP KEC - 80V -- 4NSE
		D407	0SDSI00038A	"BAV99-(F),LF DIODES R/TP SOT"
		D408	0DS226009AA	KDS226 TP KEC - 80V -- 4NSE
		D408	0SDSI00038A	"BAV99-(F),LF DIODES R/TP SOT"
		D409	0DS226009AA	KDS226 TP KEC - 80V -- 4NSE
		D410	0DS226009AA	KDS226 TP KEC - 80V -- 4NSE
		D411	0DS226009AA	KDS226 TP KEC - 80V -- 4NSE
		D412	0DS226009AA	KDS226 TP KEC - 80V -- 4NSE
		D413	0DD184009AA	KDS184 TP KEC - 85V --- 30
		D416	0DS226009AA	KDS226 TP KEC - 80V -- 4NSE
		D417	0DS226009AA	KDS226 TP KEC - 80V -- 4NSE
		D418	0DS226009AA	KDS226 TP KEC - 80V -- 4NSE
		ZD101	0DZ330009CC	MTZJ3.3B TP ROHM-K DO34 - 3.
		ZD301	0DZGD00128A	ZMM5231B GRANDE REEL TAPING
		ZD406	0DZ560009GB	"BZT52C5V6S-(F),LF DIODES R/T"
		ZD407	0DZ560009GB	"BZT52C5V6S-(F),LF DIODES R/T"
		ZD408	0DZ560009GB	"BZT52C5V6S-(F),LF DIODES R/T"
		ZD409	0DZ560009GB	"BZT52C5V6S-(F),LF DIODES R/T"
		ZD410	0DZ560009GB	"BZT52C5V6S-(F),LF DIODES R/T"
		ZD411	0DZ560009GB	"BZT52C5V6S-(F),LF DIODES R/T"
		ZD412	0DZ560009GB	"BZT52C5V6S-(F),LF DIODES R/T"
		ZD414	0DZ560009GB	"BZT52C5V6S-(F),LF DIODES R/T"
		ZD415	0DZ560009GB	"BZT52C5V6S-(F),LF DIODES R/T"
ICs				
		U101	0IPMG78425A	FAN7601 FAIRCHILD DIP-8P BUL
		U201	0IPRP00705A	FE2031-LF(TSUM56AWL) MSTAR 1
		U201	0IPMG78424A	"AZ431-A BCD 3P, TO-92 TAPING"
		U202	0IZZ9H0187A	0IMMR00004B SST SOIC 8 PIN F
		U203	0ISG240860B	"M24C08WMN6T(P),LF SGS-THOMSO"
		U301	0IPMGK2001B	AIC1117A-33PYTR(BS33) AIC 3P
		U301	0IPMG78426A	OZL68GN O2MICRO 20P SOP BULK
		U303	0IPMG00049A	"AZ1117H-1.8TRE1(EH13A),LF BC"
		U304	0IMMRSG036A	"M24C02-WMN6T(P),LF SGS-THOMS"
COILs & COREs & FILTERs				
		L202	61409B0009A	HL-1520S JEONGSAN 7.0UH 25%
		FB101	6210TCE003G	BRS3550B BO SUNG 3550MM RAD
		LF101	6200J000154	13.0*710*23680 SAMWAH BULK L
TRANSISTOR				
		Q101	0TF760000AD	SSS7N60B FAIRCHILD ST TO220F
		Q201	0TR390409AE	FAIRCHILD KST3904(LGEMTF) TP

DATE: 2006. 01. 26.				
*S	*AL	LOC. NO.	PART NO.	DESCRIPTION / SPECIFICATION
		Q301	0TR144009AI	DTA144EK CHIP TP ROHM --
		Q302	0TR144009AH	DTC144EK CHIP TP ROHM --
		Q303	0TRKE80046A	2N3904S KEC R/TP SOT23 60V 2
		Q304	0TR390609DC	2N3906S-RTK KEC REEL TAPING
		Q305	0TFDI80001A	2N7002 DIODES R/TP SOT23 60V
		Q306	0TFDI80001A	2N7002 DIODES R/TP SOT23 60V
		Q307	0TR390609DC	2N3906S-RTK KEC REEL TAPING
		Q308	0TRKE80046A	2N3904S KEC R/TP SOT23 60V 2
		Q401	0TR390609FA	FAIRCHILD KST3906-MTF TP SOT
		Q402	0TR390609FA	FAIRCHILD KST3906-MTF TP SOT
		U302	0TFVI80067A	SI3865BDV(E3) VISHAY R/TP TS
		U303	0TFAN00001A	AP4511GD ADVANCED POWER ELEC
		U304	0TFAN00001A	AP4511GD ADVANCED POWER ELEC
RESISTORs				
		R101	0RJ4703G676	470K OHM 1/4 W 5% 3216 R/TP
		R102	0RJ6801E472	6800 OHM 1/8 W 1% 2012 R/TP
		R103	0RH1004D622	1M OHM 1 / 10 W 2012 5.00% D
		R104	0RH1001D622	1K OHM 1 / 10 W 2012 5.00% D
		R105	0RD0912Q609	91 OHM 1/4 W (3.4) 5% TA52
		R106	0RH2201D622	2.2K OHM 1 / 10 W 2012 5.00%
		R107	0RD8203A609	820K OHM 1/2 W(7.0) 5.00% TA
		R108	0RD4702A609	47K OHM 1/2 W(7.0) 5.00% TA5
		R109	0RX0560J609	0.56OHM 1 W 5% TA52
		R110	0RX1003K607	100KOHM 2 W 5% TA62
		R111	0RD0471Q609	4.70 1/4W(3 5% TA52
		R112	0RJ1302E472	13K OHM 1/8 W 1% 2012 R/TP
		R115	0RJ4703G676	470K OHM 1/4 W 5% 3216 R/TP
		R116	0RJ4703G676	470K OHM 1/4 W 5% 3216 R/TP
		R117	0RH2403D622	240K OHM 1 / 10 W 2012 5.00%
		R118	0RH2403D622	240K OHM 1 / 10 W 2012 5.00%
		R201	0RJ0562D677	56 OHM 1/10 W 5% 1608 R/TP
		R202	0RJ0562D677	56 OHM 1/10 W 5% 1608 R/TP
		R202	0RX0242K665	24 OHM 2 W 5% SF
		R203	0RJ0562D677	56 OHM 1/10 W 5% 1608 R/TP
		R204	0RJ0562D677	56 OHM 1/10 W 5% 1608 R/TP
		R204	0RN3002F409	30K OHM 1/6 W 1.00% TA52
		R205	0RJ1001D677	1K OHM 1/10 W 5% 1608 R/TP
		R205	0RN2201F409	2.2K OHM 1/6 W 1.00% TA52
		R206	0RJ0562D677	56 OHM 1/10 W 5% 1608 R/TP
		R206	0RJ1601E472	1.6K OHM 1/8 W 1% 2012 R/TP
		R207	0RJ0562D677	56 OHM 1/10 W 5% 1608 R/TP
		R207	0RH1001D622	1K OHM 1 / 10 W 2012 5.00% D
		R208	0RJ4701D677	4.7K OHM 1/10 W 5% 1608 R/TP
		R208	0RH6800D622	680 OHM 1 / 10 W 2012 5.00%
		R209	0RJ4701D677	4.7K OHM 1/10 W 5% 1608 R/TP
		R209	0RH1001D622	1K OHM 1 / 10 W 2012 5.00% D
		R211	0RJ1002D677	10K OHM 1/10 W 5% 1608 R/TP
		R211	0RJ1001G476	1K OHM 1/4 W 1% 3216 R/TP
		R212	0RJ3900D677	390 OHM 1/10 W 5% 1608 R/TP
		R213	0RJ4700D677	470 OHM 1/10 W 5% 1608 R/TP
		R215	0RJ2002D677	20000 OHM 1/10 W 5% 1608 R/T
		R216	0RJ1002D677	10K OHM 1/10 W 5% 1608 R/TP
		R217	0RJ1002D677	10K OHM 1/10 W 5% 1608 R/TP
		R218	0RJ1002D677	10K OHM 1/10 W 5% 1608 R/TP
		R219	0RJ1002D677	10K OHM 1/10 W 5% 1608 R/TP
		R222	0RJ4701D677	4.7K OHM 1/10 W 5% 1608 R/TP
		R223	0RJ4701D677	4.7K OHM 1/10 W 5% 1608 R/TP
		R224	0RJ1503D677	150K OHM 1/10 W 5% 1608 R/TP
		R225	0RJ4701D677	4.7K OHM 1/10 W 5% 1608 R/TP
		R226	0RJ0332D677	33 OHM 1/10 W 5% 1608 R/TP

DATE: 2006. 01. 26.				
*S	*AL	LOC. NO.	PART NO.	DESCRIPTION / SPECIFICATION
		R227	0RJ0332D677	33 OHM 1/10 W 5% 1608 R/TP
		R228	0RJ4701D677	4.7K OHM 1/10 W 5% 1608 R/TP
		R230	0RJ0000D677	0 OHM 1/10 W 5% 1608 R/TP
		R231	0RJ0000D677	0 OHM 1/10 W 5% 1608 R/TP
		R234	0RJ4700D677	470 OHM 1/10 W 5% 1608 R/TP
		R235	0RJ4701D677	4.7K OHM 1/10 W 5% 1608 R/TP
		R301	0RD1001Q609	1K OHM 1/4 W(3.4) 5.00% TA52
		R302	0RJ5600D677	560 OHM 1/10 W 5% 1608 R/TP
		R303	0RJ2202D677	22K OHM 1/10 W 5% 1608 R/TP
		R303	0RH0222D622	22 OHM 1 / 10 W 2012 5.00% D
		R304	0RD1002Q609	10K OHM 1/4 W(3.4) 5.00% TA5
		R305	0RJ4702D677	47000 OHM 1/10 W 5% 1608 R/T
		R306	0RX0220J668	0.22 OHM 1 W 5% SF15
		R307	0RX0681K668	6.8 OHM 2 W 5% SF15
		R308	0RJ0000D677	0 OHM 1/10 W 5% 1608 R/TP
		R309	0RN1502F409	15K OHM 1/6 W 1.00% TA52
		R310	0RH1004D622	1M OHM 1 / 10 W 2012 5.00% D
		R311	0RH1502D422	"15K , 1/10W 1% TP"
		R313	0RJ6202E472	62K OHM 1/8 W 1% 2012 R/TP
		R315	0RH2001D622	2K OHM 1 / 10 W 2012 5.00% D
		R316	0RH2001D622	2K OHM 1 / 10 W 2012 5.00% D
		R317	0RJ3303E472	330000 OHM 1/8 W 1% 2012 R/T
		R318	0RJ1503E472	150K OHM 1/8 W 1% 2012 R/TP
		R319	0RH1303D622	130K OHM 1 / 10 W 2012 5.00%
		R320	0RH1502D422	"15K , 1/10W 1% TP"
		R321	0RH1002D422	10K OHM 1/10 W 1% 2012 R/TP
		R401	0RJ1001G476	1K OHM 1/4 W 1% 3216 R/TP
		R402	0RJ1001G476	1K OHM 1/4 W 1% 3216 R/TP
		R403	0RJ1001G476	1K OHM 1/4 W 1% 3216 R/TP
		R404	0RJ1001G476	1K OHM 1/4 W 1% 3216 R/TP
		R406	0RJ3600E472	360 OHM 1/8 W 1% 2012 R/TP
		R407	0RJ3600E472	360 OHM 1/8 W 1% 2012 R/TP
		R408	0RJ3600E472	360 OHM 1/8 W 1% 2012 R/TP
		R409	0RJ3600E472	360 OHM 1/8 W 1% 2012 R/TP
		R415	0RJ1200D677	120 OHM 1/10 W 5% 1608 R/TP
		R416	0RJ1200D677	120 OHM 1/10 W 5% 1608 R/TP
		R417	0RJ1000D677	100 OHM 1/10 W 5% 1608 R/TP
		R418	0RJ1000D677	100 OHM 1/10 W 5% 1608 R/TP
		R419	0RJ1000D677	100 OHM 1/10 W 5% 1608 R/TP
		R420	0RJ2001D677	2K OHM 1/10 W 5% 1608 R/TP
		R422	0RJ4701D677	4.7K OHM 1/10 W 5% 1608 R/TP
		R423	0RJ4701D677	4.7K OHM 1/10 W 5% 1608 R/TP
		R424	0RJ0000D677	0 OHM 1/10 W 5% 1608 R/TP
		R425	0RJ0122D677	12 OHM 1/10 W 5% 1608 R/TP
		R426	0RJ0122D677	12 OHM 1/10 W 5% 1608 R/TP
		R427	0RJ0122D677	12 OHM 1/10 W 5% 1608 R/TP
		R428	0RJ0122D677	12 OHM 1/10 W 5% 1608 R/TP
		R429	0RJ0122D677	12 OHM 1/10 W 5% 1608 R/TP
		R430	0RJ0122D677	12 OHM 1/10 W 5% 1608 R/TP
		R431	0RJ0222D677	22 OHM 1/10 W 5% 1608 R/TP
		R432	0RJ0222D677	22 OHM 1/10 W 5% 1608 R/TP
		R433	0RJ4700D677	470 OHM 1/10 W 5% 1608 R/TP
		R434	0RJ4701D677	4.7K OHM 1/10 W 5% 1608 R/TP
		R435	0RJ4701D677	4.7K OHM 1/10 W 5% 1608 R/TP
		R436	0RJ0332D677	33 OHM 1/10 W 5% 1608 R/TP
		R437	0RJ0332D677	33 OHM 1/10 W 5% 1608 R/TP
		R438	0RJ4701D677	4.7K OHM 1/10 W 5% 1608 R/TP
		R439	0RJ4701D677	4.7K OHM 1/10 W 5% 1608 R/TP
		R440	0RJ0332D677	33 OHM 1/10 W 5% 1608 R/TP
		R441	0RJ0000D677	0 OHM 1/10 W 5% 1608 R/TP
		R442	0RJ0682D677	68 OHM 1/10 W 5% 1608 R/TP
		R443	0RJ0682D677	68 OHM 1/10 W 5% 1608 R/TP

DATE: 2006. 01. 26.				
*S	*AL	LOC. NO.	PART NO.	DESCRIPTION / SPECIFICATION
		R444	0RJ0332D677	33 OHM 1/10 W 5% 1608 R/TP
		R445	0RJ0752D677	75 OHM 1/10 W 5% 1608 R/TP
		R446	0RJ0752D677	75 OHM 1/10 W 5% 1608 R/TP
		R448	0RJ0752D677	75 OHM 1/10 W 5% 1608 R/TP
OTHERS				
		F101	0FZZTTH001E	TIME LAG HBC 2153.15MXE(LEAD
		R201	971-0016	TIN HDC 0.60H NON NON
		R306	971-0016	TIN HDC 0.60H NON NON
		SC101	6620K00020A	HUAJIE AC UL/CSA 3PPIN BLACK
		T101	61709MC011A	EER3016 430UH LX52 LIPS SMPS
		T301	61709MC010A	EFD-2124 95UH INVERTER TRANS
		T302	61709MC010A	EFD-2124 95UH INVERTER TRANS
		TH101	6322A00035A	10D2-07 SEMITEC 100HM 15% L1
		X201	6212AA2004F	HC-49U TXC 14.318 MHZ +/- 30
CONTROL BOARD				
		R1	0RD7501Q609	7.50K 1/4W(3 5% TA52
		R2	0RD7501Q609	7.50K 1/4W(3 5% TA52
		R3	0RD1801Q609	1.8K OHM 1/4 W(3.4) 5.00% TA
		R4	0RD1201Q609	1.20K 1/4W(3 5% TA52
		R5	0RD1201Q609	1.20K 1/4W(3 5% TA52
		SW1	140-058E	SKHV10910B LGEC NON 12V 20A
		SW2	140-058E	SKHV10910B LGEC NON 12V 20A
		SW3	140-058E	SKHV10910B LGEC NON 12V 20A
		SW4	140-058E	SKHV10910B LGEC NON 12V 20A
		SW5	140-058E	SKHV10910B LGEC NON 12V 20A
		ZD401	0DZ560009AG	GDZJ5.6B TP GRANDE DO-34 500
		ZD402	0DZ560009AG	GDZJ5.6B TP GRANDE DO-34 500
		LED1	0DLLT0089AA	LITEON LTL-1BEDJ-0C2 TP GREE
POWER BOARD				
CAPACITORS				
	△	C101	0CZZ9ST017A	AL EL CAPACITOR 100UF 450V 2
		C103	0CZZ9ST014A	AL EL CAPACITOR 33UF 50V 20%
		C104	0CH5271K416	270PF 2012 50V 5% NPO R/TP
		C105	0CZZ9ST013A	AL EL CAPACITOR 0.47UF 50V 2
		C106	0CK222DK4DA	2200PF 2012 50V 5% COG R/TP
		C107	0CK1040K945	"0.1UF D 50V 80%,-20% F(Y5V)"
		C201	0CKZTTA002E	EKR3A102K09FK5 SAMWHA 1KV 10
		C202	0CZZ9ST021A	AL EL CAPACITOR 1000UF 25V 2
		C203	0CZZ9ST020A	AL EL CAPACITOR 680UF 25V 20
		C204	0CZZ9ST018A	AL EL CAPACITOR 1000UF 16V 2
		C205	0CZZ9ST018A	AL EL CAPACITOR 1000UF 16V 2
		C206	0CZZ9ST021A	AL EL CAPACITOR 1000UF 25V 2
		C207	0CZZ9ST019A	AL EL CAPACITOR 470UF 25V 20
		C208	0CKZTTA002B	330PF 1KV K R TP5.0 TAPING .
		C210	0CH3104K566	0.1UF 50V 10% X7R 2012 R/TP
		C301	0CZZTCT006D	C3216X7R1E225M TDK 25V 2.2UF
		C303	0CZZTCT006D	C3216X7R1E225M TDK 25V 2.2UF
		C304	0CZZTCT006D	C3216X7R1E225M TDK 25V 2.2UF
		C305	0CZZTCT006D	C3216X7R1E225M TDK 25V 2.2UF
		C306	0CK224DH56A	0.22UF 2012 25V 10% R/TP X7R
		C307	0CH3104K566	0.1UF 50V 10% X7R 2012 R/TP
		C308	0CK105DH56A	1UF 2012 25V 10% X7R R/TP
		C309	0CK224DH56A	0.22UF 2012 25V 10% R/TP X7R
		C310	0CK105DH56A	1UF 2012 25V 10% X7R R/TP
		C313	0CH2393K516	39000PF 50V 10% B(Y5P) 2012
		C314	0CK152DK51A	1500PF 2012 50V 10% B(Y5P) R

DATE: 2006. 01. 26.				
*S	*AL	LOC. NO.	PART NO.	DESCRIPTION / SPECIFICATION
		C315	0CH3103K516	10000PF 50V 10% B(Y5P) 2012
		C317	0CH5221K416	220PF 50V 5% NPO 2012 R/TP
		C320	0CZZTCT006D	C3216X7R1E225M TDK 25V 2.2UF
		C402	0CK22201510	2200PF D 1KV 10% B(Y5P) R
		C403	0CZZ9ST028A	CERAMIC DISK 10PF 6KV 5% TR
		C404	0CH2153K516	15000PF 50V 10% B(Y5P) 2012
		C405	0CK22201510	2200PF D 1KV 10% B(Y5P) R
		C406	0CZZ9ST028A	CERAMIC DISK 10PF 6KV 5% TR
		C407	0CH2153K516	15000PF 50V 10% B(Y5P) 2012
		C409	0CK22201510	2200PF D 1KV 10% B(Y5P) R
		C410	0CZZ9ST028A	CERAMIC DISK 10PF 6KV 5% TR
		C411	0CH2153K516	15000PF 50V 10% B(Y5P) 2012
		C412	0CK22201510	2200PF D 1KV 10% B(Y5P) R
		C413	0CZZ9ST028A	CERAMIC DISK 10PF 6KV 5% TR
		C414	0CH2153K516	15000PF 50V 10% B(Y5P) 2012
		C415	0CH2222K516	2200PF 50V 10% B(Y5P) 2012 R
		C417	0CH2222K516	2200PF 50V 10% B(Y5P) 2012 R
		C418	0CH2222K516	2200PF 50V 10% B(Y5P) 2012 R
		C419	0CH2222K516	2200PF 50V 10% B(Y5P) 2012 R
		CX101	0CZZ9ST025A	FILM CAPACITOR 0.47UF 275V 1
		CY101	0CZZ9ST024A	"Y CAPACITOR 100PF 250V 10%,-"
		CY102	0CZZ9ST024A	"Y CAPACITOR 100PF 250V 10%,-"
		CY104	0CZZ9ST023A	"Y CAPACITOR 4700PF 250V 20%,-"
		DIODES		
		BD101	0DRTW00121A	D2SB60-1121 TIWAN SEMI ST GB
		D101	0DRDI00234A	PR1007 DIODES TAPING52 DO41
		D102	0DRDI00244A	1N4007/L DIODES TAPING52 DO4
		D103	0DSGF00019A	1N4148 GULF TP DO35 100V 0.1
		D201	0DRNH00140A	FCH10U15 NIHON INTER BULK TO
		D202	0DRNH00130A	FCH10U10 NIHON INTER BULK TO
		D306	0DSGD00048A	MM4148 GRANDE REEL TAPING LL
		D401	0DSDI00038A	"BAV99-(F),LF DIODES R/TP SOT"
		D402	0DSDI00038A	"BAV99-(F),LF DIODES R/TP SOT"
		D403	0DSDI00038A	"BAV99-(F),LF DIODES R/TP SOT"
		D404	0DSDI00038A	"BAV99-(F),LF DIODES R/TP SOT"
		D405	0DSDI00038A	"BAV99-(F),LF DIODES R/TP SOT"
		D406	0DSDI00038A	"BAV99-(F),LF DIODES R/TP SOT"
		D407	0DSDI00038A	"BAV99-(F),LF DIODES R/TP SOT"
		D408	0DSDI00038A	"BAV99-(F),LF DIODES R/TP SOT"
		ZD101	0DZ330009CC	MTZJ3.3B TP ROHM-K DO34 - 3.
		ZD301	0DZGD00128A	ZMM5231B GRANDE REEL TAPING
		TRANSISTORS & ICs		
		Q101	0TF760000AD	SSS7N60B FAIRCHILD ST TO220F
		Q301	0TR144009AI	DTA144EK CHIP TP ROHM - -
		Q302	0TR144009AH	DTC144EK CHIP TP ROHM - -
		Q303	0TRKE80046A	2N3904S KEC R/TP SOT23 60V 2
		Q304	0TR390609DC	2N3906S-RTK KEC REEL TAPING
		Q305	0TFDI80001A	2N7002 DIODES R/TP SOT23 60V
		Q306	0TFDI80001A	2N7002 DIODES R/TP SOT23 60V
		Q307	0TR390609DC	2N3906S-RTK KEC REEL TAPING
		Q308	0TRKE80046A	2N3904S KEC R/TP SOT23 60V 2
		U101	0IPMG78425A	FAN7601 FAIRCHILD DIP-8P BUL
		U201	0IPMG78424A	"AZ431-A BCD 3P, TO-92 TAPING"
		U301	0IPMG78426A	OZL68GN O2MICRO 20P SOP BULK
		U303	0TFAN00001A	AP4511GD ADVANCED POWER ELEC
		U304	0TFAN00001A	AP4511GD ADVANCED POWER ELEC
		PC201	0IPMG78432A	"LTV-817M-V(C) LITEON 4P, WID"

DATE: 2006. 01. 26.				
*S	*AL	LOC. NO.	PART NO.	DESCRIPTION / SPECIFICATION
		RESISTORS		
		R101	0RJ4703G676	470K OHM 1/4 W 5% 3216 R/TP
		R102	0RJ6801E472	6800 OHM 1/8 W 1% 2012 R/TP
		R103	0RH1004D622	1M OHM 1 / 10 W 2012 5.00% D
		R104	0RH1001D622	1K OHM 1 / 10 W 2012 5.00% D
		R105	0RD0912Q609	91 OHM 1/4 W (3.4) 5% TA52
		R106	0RH2201D622	2.2K OHM 1 / 10 W 2012 5.00%
		R107	0RD8203A609	820K OHM 1/2 W(7.0) 5.00% TA
		R108	0RD4702A609	47K OHM 1/2 W(7.0) 5.00% TA5
		R109	0RX0560J609	0.56OHM 1 W 5% TA52
		R110	0RX1003K607	100KOHM 2 W 5% TA62
		R111	0RD0471Q609	4.70 1/4W(3 5% TA52
		R112	0RJ1302E472	13K OHM 1/8 W 1% 2012 R/TP
		R115	0RJ4703G676	470K OHM 1/4 W 5% 3216 R/TP
		R116	0RJ4703G676	470K OHM 1/4 W 5% 3216 R/TP
		R117	0RH2403D622	240K OHM 1 / 10 W 2012 5.00%
		R118	0RH2403D622	240K OHM 1 / 10 W 2012 5.00%
		R202	0RX0242K665	24 OHM 2 W 5% SF
		R204	0RN3002F409	30K OHM 1/6 W 1.00% TA52
		R205	0RN2201F409	2.2K OHM 1/6 W 1.00% TA52
		R206	0RJ1601E472	1.6K OHM 1/8 W 1% 2012 R/TP
		R207	0RH1001D622	1K OHM 1 / 10 W 2012 5.00% D
		R208	0RH6800D622	680 OHM 1 / 10 W 2012 5.00%
		R209	0RH1001D622	1K OHM 1 / 10 W 2012 5.00% D
		R211	0RJ1001G476	1K OHM 1/4 W 1% 3216 R/TP
		R301	0RD1001Q609	1K OHM 1/4 W(3.4) 5.00% TA52
		R303	0RH0222D622	22 OHM 1 / 10 W 2012 5.00% D
		R304	0RD1002Q609	10K OHM 1/4 W(3.4) 5.00% TA5
		R309	0RN1502F409	15K OHM 1/6 W 1.00% TA52
		R310	0RH1004D622	1M OHM 1 / 10 W 2012 5.00% D
		R311	0RH1502D422	"15K , 1/10W 1% TP"
		R313	0RJ6202E472	62K OHM 1/8 W 1% 2012 R/TP
		R315	0RH2001D622	2K OHM 1 / 10 W 2012 5.00% D
		R316	0RH2001D622	2K OHM 1 / 10 W 2012 5.00% D
		R317	0RJ3303E472	330000 OHM 1/8 W 1% 2012 R/T
		R318	0RJ1503E472	150K OHM 1/8 W 1% 2012 R/TP
		R319	0RH1303D622	130K OHM 1 / 10 W 2012 5.00%
		R320	0RH1502D422	"15K , 1/10W 1% TP"
		R321	0RH1002D422	10K OHM 1/10 W 1% 2012 R/TP
		R401	0RJ1001G476	1K OHM 1/4 W 1% 3216 R/TP
		R402	0RJ1001G476	1K OHM 1/4 W 1% 3216 R/TP
		R403	0RJ1001G476	1K OHM 1/4 W 1% 3216 R/TP
		R404	0RJ1001G476	1K OHM 1/4 W 1% 3216 R/TP
		R406	0RJ3600E472	360 OHM 1/8 W 1% 2012 R/TP
		R407	0RJ3600E472	360 OHM 1/8 W 1% 2012 R/TP
		R408	0RJ3600E472	360 OHM 1/8 W 1% 2012 R/TP
		R409	0RJ3600E472	360 OHM 1/8 W 1% 2012 R/TP
		TH101	6322A00035A	10D2-07 SEMITEC 100HM 15% L1
		TRANSFORMER		
		T101	61709MC011A	EER3016 430UH LX52 LIPS SMPS
		T301	61709MC010A	EFD-2124 95UH INVERTER TRANS
		T302	61709MC010A	EFD-2124 95UH INVERTER TRANS
		OTHERS		
		SC101	6620K00020A	HUAJIE AC UL/CSA 3PPIN BLACK
		F101	0FZZTTH001E	TIME LAG HBC 2153.15MXE(LEAD
		FB101	6210TCE003G	BRS3550B BO SUNG 3550MM RADI
		HS1	4920900021A	EXTRUSION 10*20 16 LX52
		HS2	4920900021A	EXTRUSION 10*20 16 LX52

SCHEMATIC DIAGRAM

1. SCALER

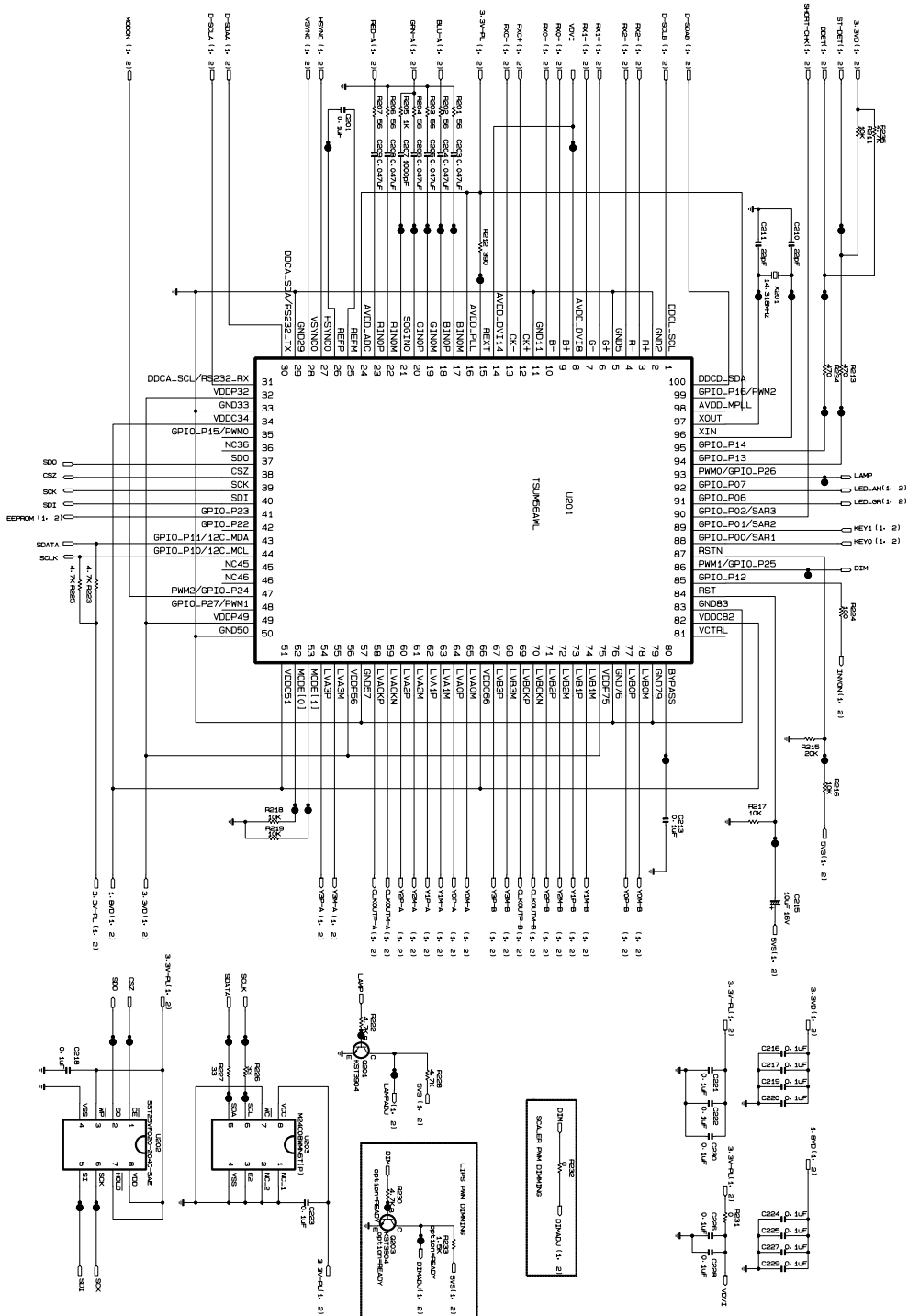

3. INVERTER

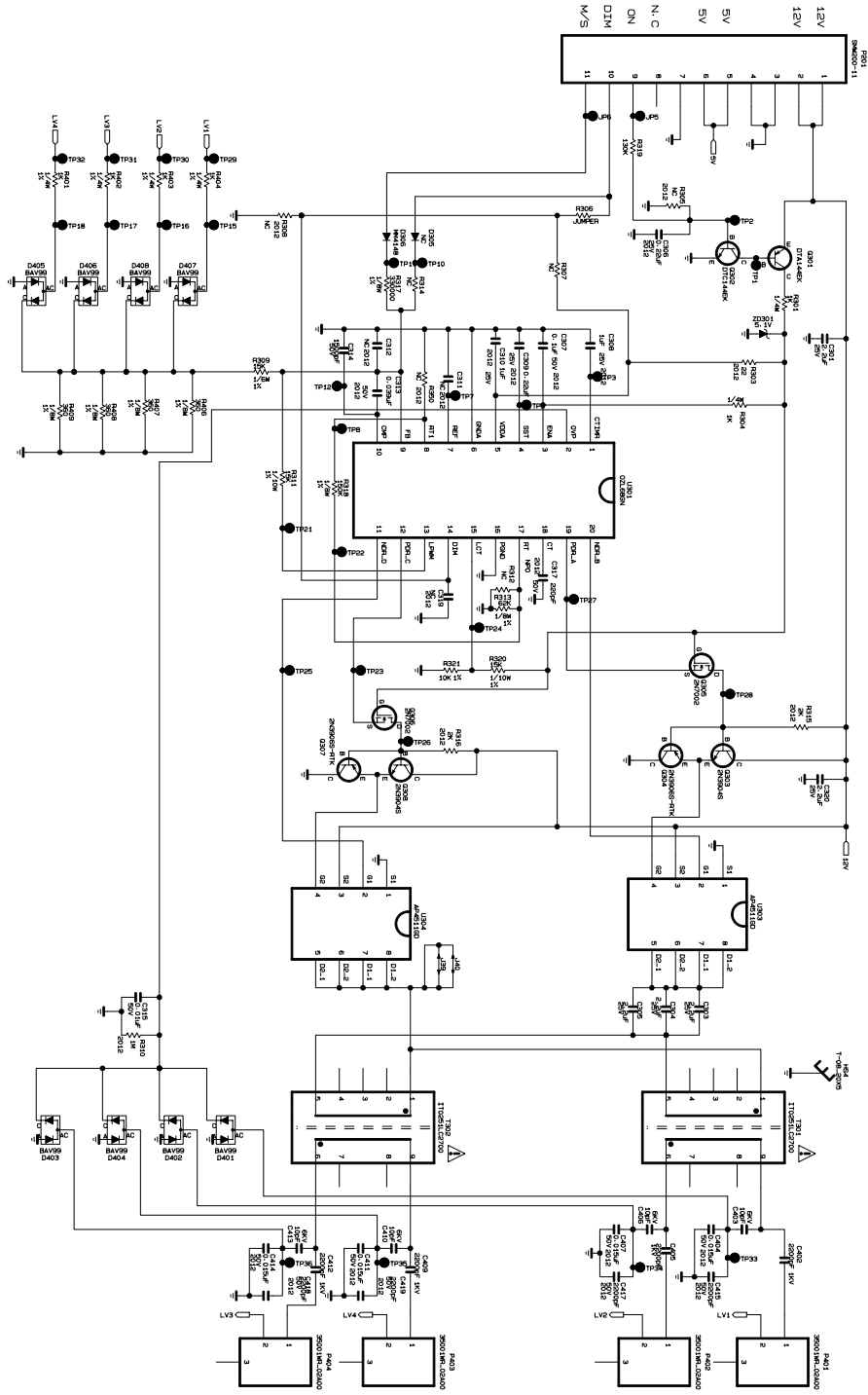

4. POWER

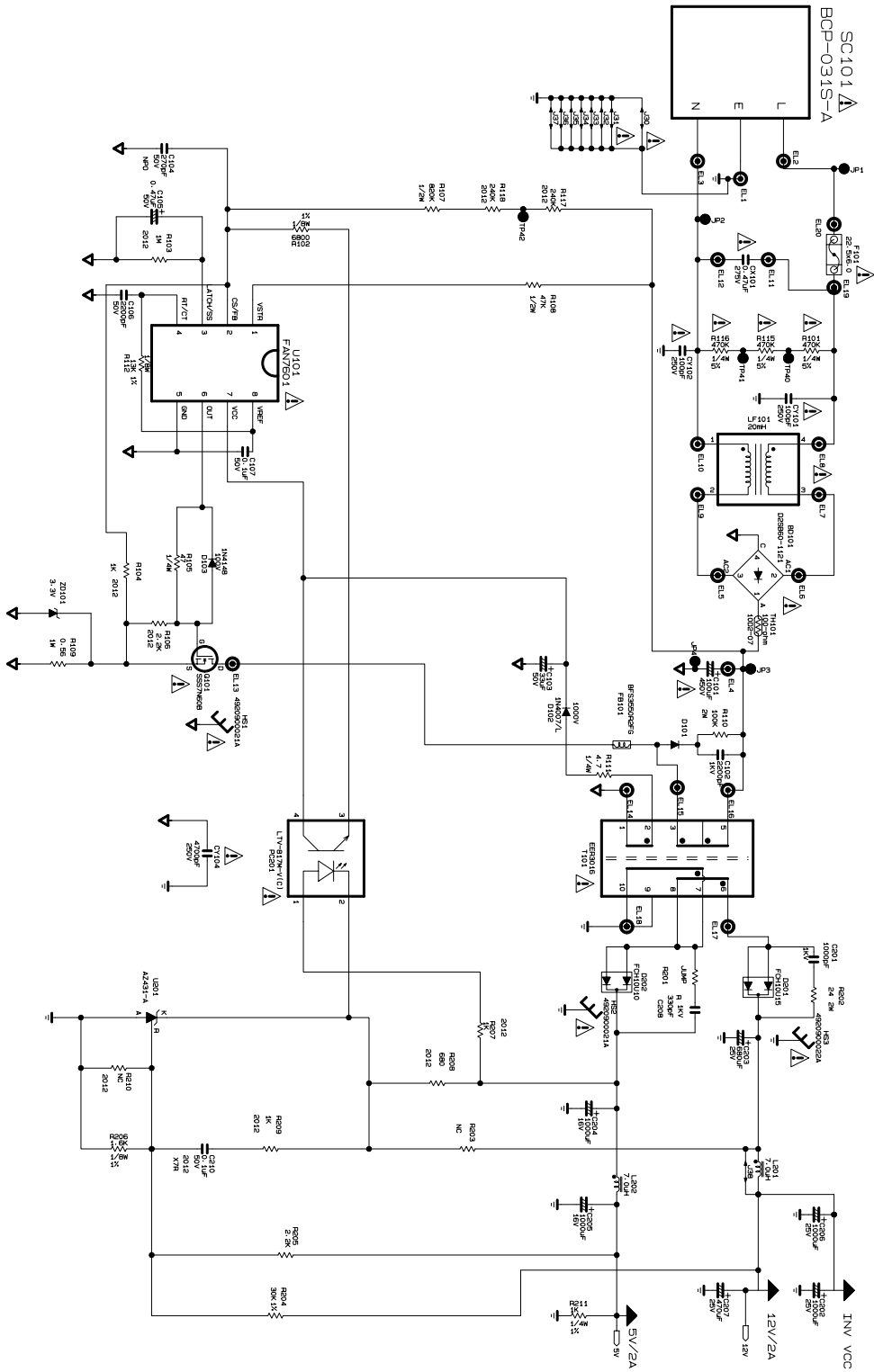



P/NO : 38289S0041W

Jan. 2006
Printed in Korea