

# NAV50 Series Service Guide

Service guide files and updates are available on the ACER/CSD web; for more information, please refer to <http://csd.acer.com.tw>

PRINTED IN TAIWAN

---

# Revision History

Please refer to the table below for the updates made to this service guide.

| Date | Chapter | Updates |
|------|---------|---------|
|      |         |         |
|      |         |         |
|      |         |         |

---

## Copyright

Copyright © 2009 by Acer Incorporated. All rights reserved. No part of this publication may be reproduced, transmitted, transcribed, stored in a retrieval system, or translated into any language or computer language, in any form or by any means, electronic, mechanical, magnetic, optical, chemical, manual or otherwise, without the prior written permission of Acer Incorporated.

## Disclaimer

The information in this guide is subject to change without notice.

Acer Incorporated makes no representations or warranties, either expressed or implied, with respect to the contents hereof and specifically disclaims any warranties of merchantability or fitness for any particular purpose. Any Acer Incorporated software described in this manual is sold or licensed "as is". Should the programs prove defective following their purchase, the buyer (and not Acer Incorporated, its distributor, or its dealer) assumes the entire cost of all necessary servicing, repair, and any incidental or consequential damages resulting from any defect in the software.

Acer is a registered trademark of Acer Corporation.

Intel is a registered trademark of Intel Corporation.

Pentium and Pentium II/III are trademarks of Intel Corporation.

Other brand and product names are trademarks and/or registered trademarks of their respective holders.

---

## Conventions

The following conventions are used in this manual:

|                        |  |
|------------------------|--|
| <b>SCREEN MESSAGES</b> | Denotes actual messages that appear on screen.                                       |
| <b>NOTE</b>            | Gives bits and pieces of additional information related to the current topic.        |
| <b>WARNING</b>         | Alerts you to any damage that might result from doing or not doing specific actions. |
| <b>CAUTION</b>         | Gives precautionary measures to avoid possible hardware or software problems.        |
| <b>IMPORTANT</b>       | Reminds you to do specific actions relevant to the accomplishment of procedures.     |

---

## Preface

Before using this information and the product it supports, please read the following general information.

1. This Service Guide provides you with all technical information relating to the BASIC CONFIGURATION decided for Acer's "global" product offering. To better fit local market requirements and enhance product competitiveness, your regional office MAY have decided to extend the functionality of a machine (e.g. add-on card, modem, or extra memory capability). These LOCALIZED FEATURES will NOT be covered in this generic service guide. In such cases, please contact your regional offices or the responsible personnel/channel to provide you with further technical details.
2. Please note WHEN ORDERING FRU PARTS, that you should check the most up-to-date information available on your regional web or channel. If, for whatever reason, a part number change is made, it will not be noted in the printed Service Guide. For ACER-AUTHORIZED SERVICE PROVIDERS, your Acer office may have a DIFFERENT part number code to those given in the FRU list of this printed Service Guide. You MUST use the list provided by your regional Acer office to order FRU parts for repair and service of customer machines.



|  |           |
|--|-----------|
| <b>System Specifications</b>               | <b>1</b>  |
| Features                                   | 1         |
| System Block Diagram                       | 4         |
| Your Acer Notebook tour                    | 5         |
| Front View                                 | 5         |
| Closed Front View                          | 6         |
| Left View                                  | 6         |
| Right View                                 | 7         |
| Rear and Base View                         | 8         |
| Indicators                                 | 9         |
| TouchPad Basics                            | 10        |
| Using the Keyboard                         | 11        |
| Lock Keys and embedded numeric keypad      | 11        |
| Windows Keys                               | 12        |
| Hot Keys                                   | 13        |
| Special Keys                               | 14        |
| Hardware Specifications and Configurations | 15        |
| <b>System Utilities</b>                    | <b>21</b> |
| BIOS Setup Utility                         | 21        |
| Navigating the BIOS Utility                | 21        |
| Information                                | 22        |
| Main                                       | 23        |
| Security                                   | 24        |
| Boot                                       | 27        |
| Exit                                       | 28        |
| BIOS Flash Utility                         | 29        |
| DOS Flash Utility                          | 30        |
| WinFlash Utility                           | 32        |
| Remove HDD/BIOS Password Utilities         | 33        |
| Miscellaneous Utilities                    | 35        |
| <b>Machine Disassembly and Replacement</b> | <b>39</b> |
| Disassembly Requirements                   | 39        |
| Related Information                        | 39        |
| General Information                        | 40        |
| Pre-disassembly Instructions               | 40        |
| Disassembly Process                        | 40        |
| External Module Disassembly Process        | 41        |
| External Modules Disassembly Flowchart     | 41        |
| Removing the Battery Pack                  | 42        |
| Removing the HDD Module                    | 43        |
| Removing the DIMM Module                   | 45        |
| Removing the WLAN Module                   | 47        |
| Removing the Back Cover                    | 49        |
| Main Unit Disassembly Process              | 50        |
| Main Unit Disassembly Flowchart            | 50        |
| Removing the Keyboard                      | 52        |
| Removing the Upper Cover                   | 54        |
| Removing the Touchpad Board                | 57        |
| Removing the LED Board                     | 58        |
| Removing the Bridge Board                  | 59        |
| Removing the Bluetooth Module              | 60        |
| Removing the Speaker Module                | 61        |

# Table of Contents

|  |     |
|--|-----|
| Removing the I/O Board . . . . .               | 63  |
| Removing the Mainboard . . . . .               | 65  |
| Removing the Thermal Module . . . . .          | 67  |
| Removing the LCD Module . . . . .              | 69  |
| LCD Module Disassembly Process . . . . .       | 71  |
| LCD Module Disassembly Flowchart . . . . .     | 71  |
| Removing the LCD Bezel . . . . .               | 72  |
| Removing the Camera Board . . . . .            | 73  |
| Removing the LCD Panel . . . . .               | 74  |
| Removing the Microphone Set . . . . .          | 75  |
| Removing the WLAN Antennas . . . . .           | 76  |
| Removing the LCD Brackets . . . . .            | 78  |
| LCD Module Reassembly Procedure . . . . .      | 80  |
| Replacing the LCD Brackets . . . . .           | 80  |
| Replacing the WLAN Antennas . . . . .          | 82  |
| Replacing the Microphone Set . . . . .         | 83  |
| Replacing the LCD Panel . . . . .              | 84  |
| Replacing the Camera Board . . . . .           | 85  |
| Replacing the LCD Bezel . . . . .              | 86  |
| Main Module Reassembly Procedure . . . . .     | 87  |
| Replacing the LCD Module . . . . .             | 87  |
| Replacing the Thermal Module . . . . .         | 89  |
| Replacing the Mainboard . . . . .              | 90  |
| Replacing the I/O Board . . . . .              | 91  |
| Replacing the Speaker Module . . . . .         | 92  |
| Replacing the Bluetooth Module . . . . .       | 92  |
| Replacing the Bridge Board . . . . .           | 93  |
| Replacing the LED Board . . . . .              | 94  |
| Replacing the Touchpad Board . . . . .         | 94  |
| Replacing the Upper Cover . . . . .            | 96  |
| Replacing the Keyboard . . . . .               | 98  |
| Replacing the WLAN Module . . . . .            | 99  |
| Replacing the DIMM Module . . . . .            | 99  |
| Replacing the Hard Disk Drive Module . . . . . | 101 |
| Replacing the Battery Pack . . . . .           | 102 |

## Troubleshooting

**103**

|  |     |
|--|-----|
| Common Problems . . . . .                | 103 |
| Power On Issue . . . . .                 | 104 |
| No Display Issue . . . . .               | 105 |
| Random Loss of BIOS Settings . . . . .   | 106 |
| LCD Failure . . . . .                    | 107 |
| Built-In Keyboard Failure . . . . .      | 107 |
| TouchPad Failure . . . . .               | 108 |
| Internal Speaker Failure . . . . .       | 109 |
| Internal Microphone Failure . . . . .    | 111 |
| HDD Not Operating Correctly . . . . .    | 112 |
| USB Failure (Rightside) . . . . .        | 113 |
| Wireless Function Test Failure . . . . . | 114 |
| 3G Function Test Failure . . . . .       | 115 |
| Switch Failure . . . . .                 | 116 |
| Thermal Units Failure . . . . .          | 117 |
| Power Button Failure . . . . .           | 117 |
| External Mouse Failure . . . . .         | 118 |
| Other Failures . . . . .                 | 118 |



# Table of Contents

|  |            |
|--|------------|
| Intermittent Problems .....                      | 119        |
| Undetermined Problems .....                      | 119        |
| Motherboard CMOS Discharge .....                 | 120        |
| POST Code Reference Tables .....                 | 121        |
| Sec: .....                                       | 121        |
| Memory: .....                                    | 121        |
| BDS & Specific action: .....                     | 122        |
| Each PEIM entry point used in 80_PORT .....      | 123        |
| Each Driver entry point used in 80_PORT .....    | 123        |
| Each SmmDriver entry point used in 80_PORT ..... | 126        |
| <b>Jumper and Connector Locations</b> .....      | <b>127</b> |
| Mainboard Top View .....                         | 127        |
| Mainboard Bottom View .....                      | 128        |
| Button Board .....                               | 129        |
| LED Board .....                                  | 130        |
| I/O Board Top View .....                         | 131        |
| I/O Board Bottom View .....                      | 132        |
| Clearing Password Check and BIOS Recovery .....  | 133        |
| Clearing Password Check .....                    | 133        |
| BIOS Recovery by Crisis Disk .....               | 134        |
| <b>FRU (Field Replaceable Unit) List</b> .....   | <b>135</b> |
| NAV50 Exploded Diagrams .....                    | 136        |
| Main Assembly .....                              | 136        |
| Rear Assembly .....                              | 137        |
| Upper Cover Assembly .....                       | 138        |
| NAV50 FRU List .....                             | 139        |
| Screw List .....                                 | 145        |
| <b>Model Definition and Configuration</b> .....  | <b>146</b> |
| NAV50 .....                                      | 146        |
| <b>Test Compatible Components</b> .....          | <b>209</b> |
| Windows Environment Test .....                   | 210        |
| <b>Online Support Information</b> .....          | <b>213</b> |
| <b>Index</b> .....                               | <b>215</b> |

# ***Table of Contents***

# System Specifications

---

## Features

Below is a brief summary of the computer's many features:

**NOTE:** Items denoted with (\*) are only available for specific models.

## Operating System

- Genuine Windows® XP Home (Service Pack 3)\*
- Genuine Windows® 7 Starter\*
- Genuine Windows® 7 Home Basic (China only)\*

## Platform

- Mobile Intel® NM10 Express Chipset
- Acer InviLink™ 802.11b/g

## System Memory

- Single channel with one soDIMM slot:
  - DDR2 667 MHz SDRAM memory interface design
  - soDIMM slot: Supports 1 GB/2 GB soDIMMs for total system memory of up to 2 GB

## Display and graphics

- 10.1" HD 1280 x 720 (WXGA) pixel resolution, high brightness (200-nit) Acer CrystalBrite™ LED-backlit TFT LCD
- 10.1" SD 1024 x 600 (WSVGA) pixel resolution, high brightness (200-nit) Acer CrystalBrite™ LED-backlit TFT LCD

## Storage subsystem

- 2.5" 9.5 mm 160/250 GB or larger hard disk drive
- Multi-in-1 card reader

## Audio

- High-definition audio support
- Two built-in stereo speakers
- MS-Sound compatible
- Built-in digital microphone

## Dimensions and Weight

- 258.5 (W) x 185 (D) x 25.2 (H) mm (10.17 x 7.28 x 0.99 inches)

- 
- 1.1 kg (2.43 lbs.) with 3-cell battery pack
  - 1.25 kg (2.76 lbs.) with 6-cell battery pack

## Communication

- Acer Crystal Eye webcam, with 640 x 480 resolution, supporting enhanced Acer PrismaLite™ technology
- WLAN: Acer InViLink™ Nplify™ 802.11b/g/n Wi-Fi CERTIFIED™, supporting Acer SignalUp™ wireless technology
- WLAN: Acer InViLink™ 802.11b/g Wi-Fi CERTIFIED™, supporting Acer SignalUp™ wireless technology
- WPAN: Bluetooth® 2.1+EDR
- WWAN: UMTS/HSPA at 850/900/1900/2100 MHz and quad-band GSM/GPRS/EDGE(850/900/1800/1900 MHz), upgradeable to 7.2 Mb/s HSDPA and 5.7 Mb/s HSUPA, supporting receiver diversity and equalizing at 2100 MHz (for 3G models)
- LAN: 10/100 Mbps Fast Ethernet

## Privacy control

- BIOS user, supervisor, HDD passwords
- Kensington lock slot

## Special keys and controls

- 84-/85-/88-key keyboard, 93% standard size
- Multi-gesture touchpad pointing device

## Power

- 63 W 5600 mAh 6-cell Li-ion battery pack
  - 10-hour battery life
- 48 W 4400 mAh 6-cell Li-ion battery pack
  - 8-hour battery life
- 24 W 2200 mAh 3-cell Li-ion battery pack
  - 4-hour battery life
- ENERGY STAR®

## I/O interface

- Multi-in-1 card reader
- Three USB 2.0 ports
- External display (VGA) port
- Headphone/speaker/line-out jack
- Microphone-in jack
- Ethernet (RJ-45) port
- DC-in jack for AC adapter

---

## Environment

- Temperature:
  - Operating: 5 °C to 35 °C
  - Non-operating: -20 °C to 65 °C
- Humidity (non-condensing):
  - Operating: 20% to 80%
  - Non-operating: 20% to 80%

# System Block Diagram

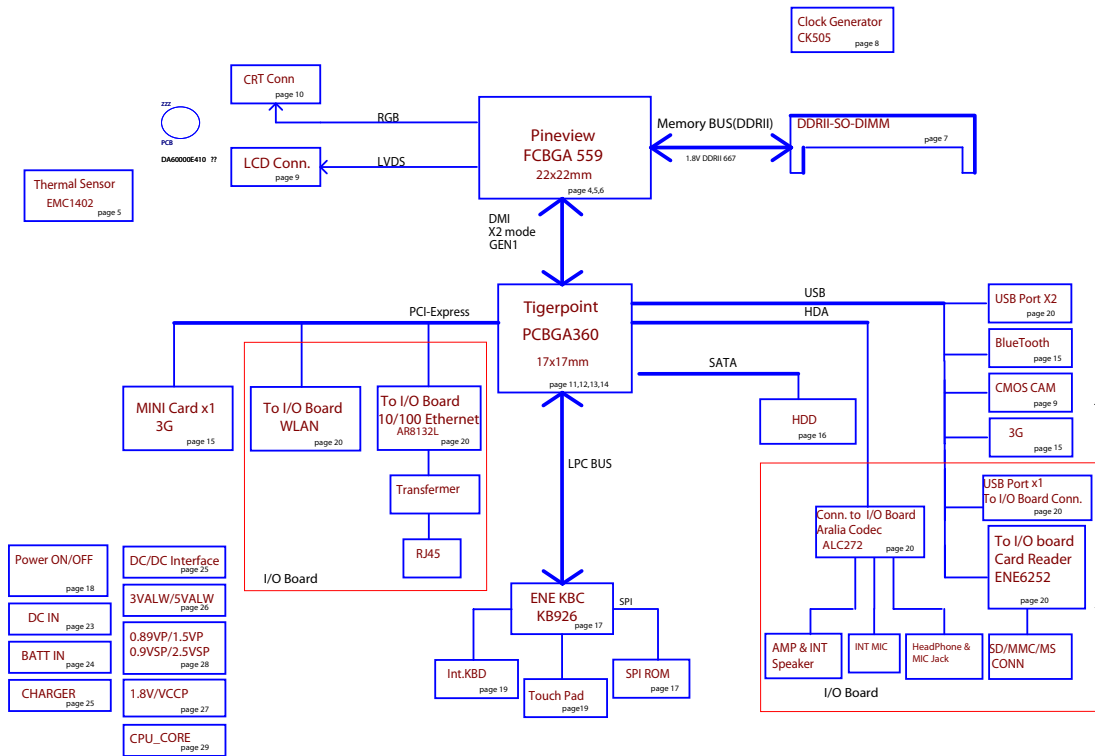



---





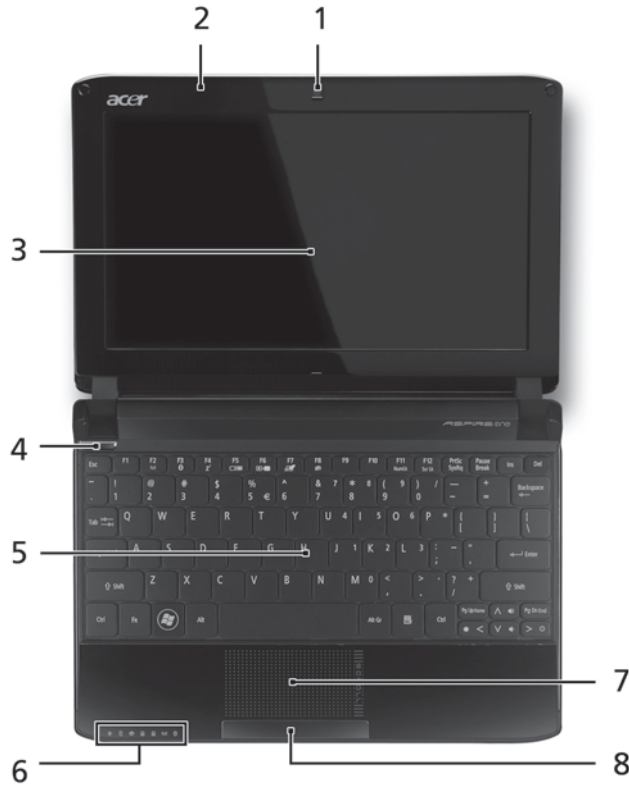

# Your Acer Notebook tour

After learning about your computer features, let us show you around your new computer.

## Front View



| No. | Icon  | Item                       | Description   |
|-----|---|----------------------------|---|
| 1   |   | Acer Crystal Eye Webcam    | Web camera for video communication.                                 |
| 2   |  | Microphone                 | Internal microphone for sound recording.                            |
| 3   |   | Display screen             | Also called Liquid-Crystal Display (LCD), displays computer output. |
| 4   |  | Power button/<br>indicator | Turns the computer on and off.                                      |
| 5   |   | Keyboard                   | For entering data into your computer.                               |

| No. | Icon  | Item                                    | Description  |
|-----|---|---|--|
| 6   |  | Power indicator                         | Indicates the computer's power status.                                     |
|     |  | Battery indicator                       | Indicates the computer's battery status.                                   |
|     |  | HDD indicator                           | Indicates when the hard disk drive is active.                              |
|     |  | Num Lock indicator                      | Lights up when Num Lock is activated.                                      |
|     |  | Caps Lock indicator                     | Lights up when Caps Lock is activated.                                     |
|     |  | 3G/Wireless LAN communication indicator | Indicates the status of 3G/Wireless LAN communication.                     |
|     |  | Bluetooth communication indicator       | Indicates the status of the Bluetooth communication.                       |
| 7   |   | TouchPad                                | Touch-sensitive pointing device which functions like a computer mouse.     |
| 8   |   | Click buttons (left and right)          | The left and right buttons function like the left and right mouse buttons. |



## Closed Front View

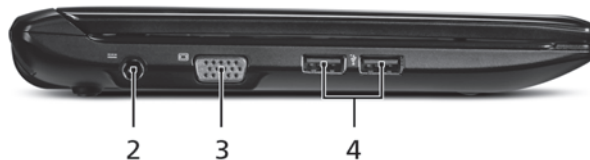

| No. | Icon | Item              | Description  |
|-----|------|-------------------|--|
| 1   |      | Status indicators | Light-Emitting Diodes (LED) that light up to show the status of the computer's functions and components. |

## Left View









| No. | Icon  | Item                        | Description   |
|-----|---|-----------------------------|---|
| 2   |  | DC-in jack                  | Connects to an AC adapter.  |
| 3   |  | External display (VGA) port | Connects to a display device (e.g., external monitor, LCD projector). |

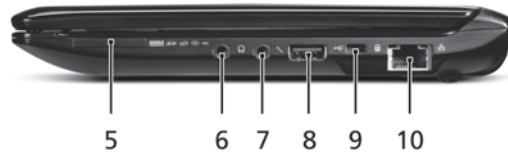

| No. | Icon  | Item         | Description                                    |
|-----|---|--------------|--|
| 4   |  | USB 2.0 port | Connects to USB 2.0 devices (e.g., USB mouse). |







## Right View



| No. | Icon  | Item                            | Description  |
|-----|---|---------------------------------|--|
| 5   |    | Multi-in-one card reader        | Accepts Secure Digital (SD), MultiMediaCard (MMC), Memory Stick (MS), Memory Stick PRO (MS PRO), xD-Picture Card (xD).<br><b>Note:</b> Push to remove/install the card. Only one card can operate at any given time. |
| 6   |    | Headphone speaker/line-out jack | Connects to line-out audio devices (e.g., speakers, headphones).   |
| 7   |    | Microphone-in jack              | Accepts input from external microphones.   |
| 8   |   | USB 2.0 port                    | Connects to USB 2.0 devices (e.g., USB mouse).   |
| 9   |  | Kensington lock slot            | Connects to a Kensington-compatible computer security lock.  |
| 10  |  | Ethernet (RJ-45) port           | Connects to an Ethernet 10/100-based network.  |

## Rear and Base View









| No. | Icon  | Item  | Description  |
|-----|---|---|--|
| 11  |    | Battery bay                                       | Houses the computer's battery pack.<br><b>Note:</b> The battery shown is for reference only. Your PC may have a different battery, depending on the model purchased. |
| 12  |   | Battery release latch                             | Releases the battery for removal.  |
| 13  |  | Hard disk/3G<br>Wireless LAN<br>communication bay | Houses the computer's hard disk/3G/ Wireless LAN communication (secured with screws).  |
| 14  |   | Ventilation slots and/<br>or cooling fan          | Enables the computer to stay cool, even after prolonged use.<br><b>Note:</b> Do not cover or obstruct the opening of the fan.  |
| 15  |  | 3G SIM card slot                                  | Accepts a 3G SIM card for 3G connectivity (only for certain models).   |
| 16  |  | Battery lock                                      | Locks the battery in position.   |
| 17  |  | Memory<br>compartment                             | Houses the computer's main memory.   |

---

## Indicators

The computer has several easy-to-read status indicators. The battery indicator is visible even when the computer cover is closed.

| Icon  | Function                                | Description  |
|---|---|--|
|  | Power indicator                         | Indicates the computer's power status.                 |
|  | Battery indicator                       | Indicates the computer's battery status.               |
|  | HDD indicator                           | Indicates when the hard disk drive is active.          |
|  | Num Lock indicator                      | Lights up when Num Lock is activated.                  |
|  | Caps Lock indicator                     | Lights up when Caps Lock is activated.                 |
|  | 3G/Wireless LAN communication indicator | Indicates the status of 3G/Wireless LAN communication. |
|  | Bluetooth communication indicator       | Indicates the status of the Bluetooth communication.   |

**NOTE:** 1. **Charging:** The battery light shows amber when the battery is charging. 2. **Fully charged:** The light shows green when in AC mode.

# TouchPad Basics

The following items show you how to use the TouchPad:

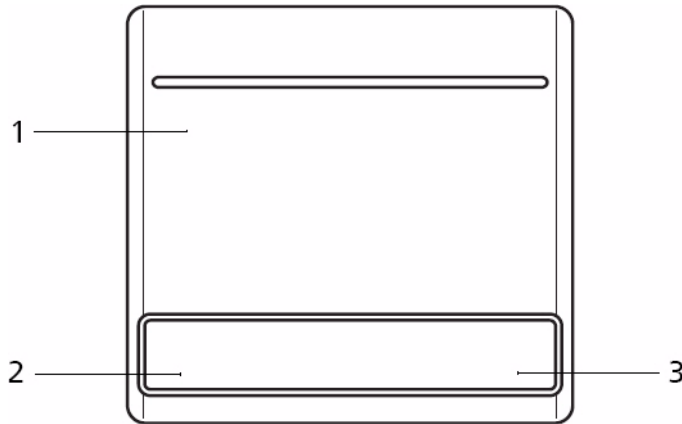

- Move your finger across the TouchPad (1) to move the cursor.
- Press the left (2) and right (3) buttons located beneath the TouchPad to perform selection and execution functions. These two buttons are similar to the left and right buttons on a mouse. Tapping on the TouchPad is the same as clicking the left button.

| Function            | Left Button (2)   | Right Button (3) | Main TouchPad (1)  |
|---------------------|---|------------------|--|
| Execute             | Quickly click twice.  |                  | Tap twice (at the same speed as double-clicking a mouse button).   |
| Select              | Click once.   |                  | Tap once.  |
| Drag                | Click and hold, then use finger on the TouchPad to drag the cursor. |                  | Tap twice (at the same speed as double-clicking a mouse button); rest your finger on the TouchPad on the second tap and drag the cursor. |
| Access context menu |   | Click once.      |  |

**NOTE:** When using the TouchPad, keep it - and your fingers - dry and clean. The TouchPad is sensitive to finger movement; hence, the lighter the touch, the better the response. Tapping too hard will not increase the TouchPad's responsiveness.

---

# Using the Keyboard

Your NAV50 has a close-to-full-sized keyboard and an embedded numeric keypad, separate cursor, lock, function and special keys.

## Lock Keys and embedded numeric keypad

The keyboard has three lock keys which you can toggle on and off.

















| Lock key                 | Description  |
|--------------------------|--|
| Caps Lock                | When Caps Lock is on, all alphabetic characters typed are in uppercase.  |
| Num Lock<br><Fn> + <F11> | When Num Lock is on, the embedded keypad is in numeric mode. The keys function as a calculator (complete with the arithmetic operators +, -, *, and /). Use this mode when you need to do a lot of numeric data entry. A better solution would be to connect an external keypad. |
| Scroll Lock <Fn> + <F12> | When Scroll Lock is on, the screen moves one line up or down when you press the up or down arrow keys respectively. Scroll Lock does not work with some applications.  |

The embedded numeric keypad functions like a desktop numeric keypad. It is indicated by small characters located on the upper right corner of the keycaps. To simplify the keyboard legend, cursor-control key symbols are not printed on the keys.

| Desired access                         | Num Lock on  | Num Lock off                               |
|--|--|--|
| Number keys on embedded keypad         | Type numbers in a normal manner.                   |  |
| Cursor-control keys on embedded keypad | Hold <Shift> while using cursor-control keys.      | Hold <Fn> while using cursor-control keys. |
| Main keyboard keys                     | Hold <Fn> while typing letters on embedded keypad. | Type the letters in a normal manner.       |

# Windows Keys











The keyboard has two keys that perform Windows-specific functions.

| Key   | Description  |
|---|--|
|  Windows key       | <p>Pressed alone, this key has the same effect as clicking on the Windows Start button; it launches the Start menu. It can also be used with other keys to provide a variety of functions:</p> <ul style="list-style-type: none"><li>&lt;  &gt;: Open or close the Start menu</li><li>&lt;  &gt; + &lt;D&gt;: Display the desktop</li><li>&lt;  &gt; + &lt;E&gt;: Open Windows Explore</li><li>&lt;  &gt; + &lt;F&gt;: Search for a file or folder</li><li>&lt;  &gt; + &lt;L&gt;: Lock your computer (if you are connected to a network domain), or switch users (if you're not connected to a network domain)</li><li>&lt;  &gt; + &lt;M&gt;: Minimizes all windows</li><li>&lt;  &gt; + &lt;R&gt;: Open the Run dialog box</li><li>&lt;  &gt; + &lt;U&gt;: Open Ease of Access Center</li><li>&lt;  &gt; + &lt;BREAK&gt;: Display the System Properties dialog box</li><li>&lt;  &gt; + &lt;SHIFT+M&gt;: Restore minimized windows to the desktop</li><li>&lt;  &gt; + &lt;TAB&gt;: Cycle through programs on the taskbar by using Windows Flip 3-D</li><li>&lt;  &gt; + &lt;SPACEBAR&gt;: Bring all gadgets to the front and select Windows Sidebar</li><li>&lt;CTRL&gt; + &lt;  &gt; + &lt;F&gt;: Search for computers (if you are on a network)</li><li>&lt;CTRL&gt; + &lt;  &gt; + &lt;TAB&gt;: Use the arrow keys to cycle through programs on the taskbar by using Windows Flip 3-D</li></ul> <p><b>Note:</b> Depending on your edition of Windows, some shortcuts may not function as described.</p> |
|  Application key | This key has the same effect as clicking the right mouse button; it opens the application's context menu.  |

# Hot Keys

The computer employs hotkeys or key combinations to access most of the computer's controls like screen brightness and volume output.

To activate hotkeys, press and hold the **<Fn>** key before pressing the other key in the hotkey combination.

| Hotkey      | Icon  | Function                  | Description   |
|-------------|---|---------------------------|---|
| <Fn> + <F1> | ?   | Hotkey help               | Displays help on hotkeys.   |
| <Fn> + <F2> |    | Acer eSettings Management | Launches Acer eSettings Management in Acer Empowering Technology.                             |
| <Fn> + <F3> |    | Acer ePower Management    | Launches Acer ePower Management in Acer Empowering Technology.                                |
| <Fn> + <F4> | Z <sup>z</sup>  | Sleep                     | Puts the computer in Sleep mode.  |
| <Fn> + <F5> |    | Display toggle            | Switches display output between the display screen, external monitor (if connected) and both. |
| <Fn> + <F6> |    | Screen blank              | Turns the display screen backlight off to save power. Press any key to return.                |
| <Fn> + <F7> |    | TouchPad toggle           | Turns the internal TouchPad on and off.   |
| <Fn> + <F8> |    | Speaker toggle            | Turns the speakers on and off.  |
| <Fn> + <▷>  |    | Brightness up             | Increases the screen brightness.  |
| <Fn> + <◁>  |   | Brightness down           | Decreases the screen brightness.  |
| <Fn> + <△>  |  | Volume up                 | Increases the sound volume.   |
| <Fn> + <▽>  |  | Volume down               | Decreases the sound volume.   |

---

## Special Keys

You can locate the Euro symbol and the US dollar sign at the upper-center and/or bottom-right of your keyboard.

### The Euro symbol

1. Open a text editor or word processor.
2. Hold <Alt Gr> and then press the <5> key at the upper-center of the keyboard.

**NOTE:** Some fonts and software do not support the Euro symbol. See [www.microsoft.com/typography/faq/faq12.htm](http://www.microsoft.com/typography/faq/faq12.htm) for more information.

### The US dollar sign

1. Open a text editor or word processor.
2. Hold <Shift> and then press the <4> key at the upper-center of the keyboard.

**NOTE:** This function varies according to the language settings.



# Hardware Specifications and Configurations

## Processor

| Item        | Specification   |
|-------------|---|
| CPU type    | Intel® Pineview-M (N450, N470) Processor  |
| CPU package | Micro-FCBGA8 packaging  |
| Core Logic  | <ul style="list-style-type: none"> <li>Intel 945GSE Express chipset</li> <li>ICH7M Intel 82801GBM</li> <li>On die 512-kB, 8-way L2 cache</li> </ul>   |
| Chipset     | <ul style="list-style-type: none"> <li>Tiger Point Chipset (NM10)</li> <li>ENE KB926 for Keyboard Controller, Battery management Unit, and RTC.</li> <li>Realtek ALC272X-GR for High Definition Audio Codec.</li> <li>Atheros AR8132 for 10/100 LAN.</li> <li>ENE UB6252 card reader support MS, MS Pro, SD, MMC, xD</li> </ul> |

## Processor Specifications

| Item | CPU Speed | Cores | Bus Speed | Mfg Tech | Cache Size | Package      | Core Voltage | Acer P/N     |
|------|-----------|-------|-----------|----------|------------|--------------|--------------|--------------|
| N450 | 1.66 GHz  | 1     | 533 MHz   | 45 nm    | 512 KB     | Micro-FCBGA8 | 0.9V-1.100V  | KC.ANB01.450 |

## CPU Fan True Value Table

| CPU Temperature of Diode | Fan Speed (RPM) | SPL Spec (dBA) |
|--------------------------|-----------------|----------------|
| 43                       | 5200            | 26             |
| 50                       | 5700            | 29             |
| 55                       | 6000            | 31             |

- Throttling 50%: On= 95°C; OFF=80°C
- OS shut down at 100°C; H/W shut down at 90°C

### System Memory

| Item                            | Specification   |
|---------------------------------|---|
| Memory controller               | Built in  |
| Memory size                     | 512MB or 1GB DDR2 RAM (if 2Gb die support is available) |
| DIMM socket number              | 1   |
| Supports memory size per socket | 2 GB  |
| Supports maximum memory size    | 2 GB  |
| Supports DIMM type              | DDR II 533Mhz SDRAM memory interface design             |
| Supports DIMM Speed             | 533Mhz SDRAM  |

### System Storage

| Item | Specification   |
|------|---|
| HDD  | <ul style="list-style-type: none"> <li>• 9.5mm height, 2.5" HDD</li> <li>• Easily removable no more than two screws</li> <li>• SATA bus</li> <li>• 160/250GB and above</li> <li>• 5400 rpm</li> <li>• SATA connector BTO</li> </ul> |

### Hard Disk Drive Interface

| Item                                      | Specification       |                     |                     |                                 |                          |
|---|---------------------|---------------------|---------------------|---------------------------------|--------------------------|
| Vendor & Model Name                       | Seagate ST9160310AS | Seagate ST9250827AS | Seagate ST9250315AS | HGST L9A300 HTS543225 HTS543216 | WD WD2500BEVT WD1600BEVT |
| Capacity (GB)                             | 160                 | 250                 | 250                 | 250, 160                        | 250, 160                 |
| Bytes per sector                          | 512                 | 512                 | 512                 | 512                             | 512                      |
| Data heads                                | 2                   | 4                   | 2                   | 3, 2                            | 3, 2                     |
| Drive Format                              |                     |                     |                     |                                 |                          |
| Disks                                     | 1                   | 2                   | 1                   | 2, 1                            | 2, 1                     |
| Spindle speed (RPM)                       | 5400                | 5400                | 5400                | 5400                            | 5400                     |
| Performance Specifications                |                     |                     |                     |                                 |                          |
| Buffer size                               | 8 MB                | 8 MB                | TBD                 | 8 MB                            | 8 MB                     |
| Interface                                 | SATA                | SATA                | SATA                | SATA                            | SATA                     |
| Fast data transfer rate (Mbits/sec, max)  | 352                 | 778                 | TBD                 | 3000                            | 3000                     |
| Media data transfer rate (Mbytes/sec max) | 150                 | 300                 | TBD                 | 775                             | 850                      |
| DC Power Requirements                     |                     |                     |                     |                                 |                          |
| Voltage tolerance                         | 5V ±5%              | 5V ±5%              | TBD                 | 5V ±5%                          | 5V ±5%                   |

### Hard Disk Drive Interface (cont.)

| Item                                      | Specification     |                   |
|---|-------------------|-------------------|
| Vendor & Model Name                       | Toshiba MK1652GSX | Toshiba MK1655GSX |
| Capacity (GB)                             | 160               | 160               |
| Bytes per sector                          | 512               |                   |
| Data heads                                | 2                 | 2                 |
| Drive Format                              |                   |                   |
| Disks                                     | 1                 | 1                 |
| Spindle speed (RPM)                       | 5400              | 5400              |
| Performance Specifications                |                   |                   |
| Buffer size (MB)                          | 8                 | 8                 |
| Interface                                 | SATA              | SATA              |
| Fast data transfer rate (Mbits/sec, max)  | 400 - 794 typical | 395 - 952 typical |
| Media data transfer rate (Gbytes/sec max) | 3                 | 3                 |
| DC Power Requirements                     |                   |                   |
| Voltage tolerance                         | 5V $\pm$ 5%       | 5V $\pm$ 5%       |

### BIOS

| Item          | Specification  |
|---------------|--|
| BIOS vendor   | InsydeH20  |
| BIOS Version  | V0.12_Mac  |
| BIOS ROM type | Flash  |
| BIOS ROM size | 1 MB   |
| Features      | <ul style="list-style-type: none"> <li>• Support ISIPP</li> <li>• Support Acer UI</li> <li>• Support multi-boot</li> <li>• Suspend to RAM (S3)/Disk (S4)</li> <li>• Various hot-keys for system control</li> <li>• Support SMBUS 2.0, PCI2.3</li> <li>• ACPI 2.0 compliance with Intel Speed Step Support C1, C2, C3, C4 and S3, S4 for mobile CPU</li> <li>• DMI utility for BIOS serial number configurable/asset tag</li> <li>• Support PXE</li> <li>• Support Y2K solution</li> <li>• Support Win Flash Wake on LAN from S3</li> <li>• Wake on LAN from S4 in AC mode</li> <li>• System information</li> </ul> |

### LED 10.1"

| Item                        | Specification   |
|-----------------------------|---|
| Vendor/model name           | Chimei N101L6-L02, AUO B101AW03 V0, Samsung LTN101NT02-A01, LPL LP101WSA-TLA1 |
| Screen Diagonal (mm)        | 257 (10.1")   |
| Active Area (mm)            | 222.72x125.28   |
| Display resolution (pixels) | 1024x576  |

| Item  | Specification       |
|---|---------------------|
| Pixel Pitch (mm)  | 0.2175              |
| Typical White Luminance (cd/m <sup>2</sup> )<br>also called Brightness                          | 200                 |
| Contrast Ratio  | 500:1               |
| Response Time (Optical Rise<br>Time/Fall Time) msec   | 10                  |
| Typical Power Consumption<br>(watt)   | 2.5                 |
| Weight (without inverter)   | 180                 |
| Physical Size (mm)  | 235.5 x 143.5 x 5.2 |
| Electrical Interface  | LVDS                |
| Viewing Angle (degree)<br>Horizontal (Right) CR = 10 (Left)<br>Vertical (Upper) CR = 10 (Lower) | 45/45<br>20/45      |

#### Audio Codec and Amplifier

| Item                | Specification  |
|---------------------|--|
| Audio<br>Controller | REALTEK ALC272X-GR   |
| Features            | <ul style="list-style-type: none"> <li>Two stereo DAC support 16/20/24-bit PCM for two independent playback (multiple streaming)</li> <li>Two stereo ADC supports 16/20/24-bit PCM format for two independent recording</li> <li>All DACs support independent 44.1k/48k/96k/192kHz sample rate</li> <li>All ADCs support independent 44.1k/48k/96k/192kHz sample rate</li> <li>Two independent SPDIF outputs support 16/20/24-bit format and 44.1k/48k/88.2k/96k/192kHz rate</li> <li>Supports line level mono output</li> <li>Supports analog PCBEEP input, and features an integrated digital BEEP generator</li> <li>Support two stereo digital microphone input for microphone array AEC/BF application</li> <li>Supports legacy analog mixer architecture</li> <li>Supports two GPIO (General Purpose Input/Output) pins (pin sharing with digital microphone interface)</li> <li>Supports EAPD (External Amplifier Power Down) control for external amplifier</li> <li>Supports anti-pop mode when analog power AVDD is on and digital power is off</li> <li>Supports 1.5V~3.3V scalable I/O for HD Audio link</li> <li>48-pin LQFP 'Green' package</li> </ul> |

#### LAN Interface

| Item        | Specification   |
|-------------|---|
| LAN Chipset | Atheros AR8114/AR8132   |
| Features    | <ul style="list-style-type: none"> <li>Supports 10/100</li> </ul> |

#### Keyboard

| Item                    | Specification          |
|-------------------------|------------------------|
| Type                    | New Acer flat keyboard |
| Total number of keypads | 84-/85-/88-key         |
| Windows logo key        | Yes                    |

| Item   | Specification   |
|--|---|
| Internal & external keyboard work simultaneously | Plug USB keyboard to the USB port directly: Yes   |
| Features   | <ul style="list-style-type: none"> <li>• 2.0+/- 3mm full stroke keys</li> <li>• Phantom key auto detect</li> <li>• Overlay numeric keypad</li> <li>• Support independent pgdn/pgup/pgup/home/end keys</li> <li>• Support reverse T cursor keys</li> <li>• Factory configurable different languages by OEM customer</li> </ul> |

#### Camera

| Item             | Specification                           |
|------------------|---|
| Vendor and model | Suyin Camera Rosa<br>Liteon Camera Lily |
| Type             | 0.3M LDV                                |

#### 3G Card

| Item     | Specification   |
|----------|---|
| Features | <ul style="list-style-type: none"> <li>• 3G card in mini-PCI card size</li> <li>• Control by USB interface</li> <li>• User accessible SIM card by battery remove</li> <li>• Antenna: Has to be placed on the sides of LCD in A/B cover</li> </ul> |

#### Wireless LAN

| Item     | Specification   |
|----------|---|
| Type     | WiMax Intel Echo Peak 5150  |
| Features | <ul style="list-style-type: none"> <li>• 802.16e+802.11a/g/h</li> <li>• 1x2 MIMO</li> <li>• Mini card/Half Mini card</li> </ul> |

#### Battery

| Item                   | Specification  |  |
|------------------------|--|--|
| Vendor & model name    | SANYO UM-2008A,<br>PANASONIC UM-2008AW,<br>SIMPLO UM-2008A | SANYO UM-2008BW,<br>PANASONIC UM-2008B,<br>SIMPLO UM-2008A |
| Battery Type           | Li-ion   | Li-ion   |
| Pack capacity          | 2200/2900 mAh  | 4400/5800 mAh  |
| Number of battery cell | 3  | 6  |
| Package configuration  | 3S1P   | 3S2P   |



# System Utilities

---

## BIOS Setup Utility

The BIOS Setup Utility is a hardware configuration program built into your computer's BIOS (Basic Input/Output System).

Your computer is already properly configured and optimized, and you do not need to run this utility. However, if you encounter configuration problems, you may need to run Setup. Please also refer to Chapter 4 Troubleshooting when problem arises.

To activate the BIOS Utility, press **F2** during POST (when **Press <F2> to enter Setup** message is prompted on the bottom of screen).

Press **F2** to enter setup. The default parameter of F12 Boot Menu is set to "disabled". If you want to change boot device without entering BIOS Setup Utility, please set the parameter to "enabled".

Press **<F12>** during POST to enter multi-boot menu. In this menu, user can change boot device without entering BIOS SETUP Utility.

## Navigating the BIOS Utility

There are six menu options: Information, Main, Advanced, Security, Power, Boot, and Exit.

Follow these instructions:

- To choose a menu, use the left and right arrow keys.
- To choose an item, use the up and down arrow keys.
- To change the value of a parameter, press **F5** or **F6**.
- A plus sign (+) indicates the item has sub-items. Press **Enter** to expand this item.
- Press **Esc** while you are in any of the menu options to go to the Exit menu.
- In any menu, you can load default settings by pressing **F9**. You can also press **F10** to save any changes made and exit the BIOS Setup Utility.

**NOTE:** You can change the value of a parameter if it is enclosed in square brackets. Navigation keys for a particular menu are shown on the bottom of the screen. Help for parameters are found in the Item Specific Help part of the screen. Read this carefully when making changes to parameter values. **Please note that system information is subject to different models.**

# Information

The Information screen displays a summary of your computer hardware information.

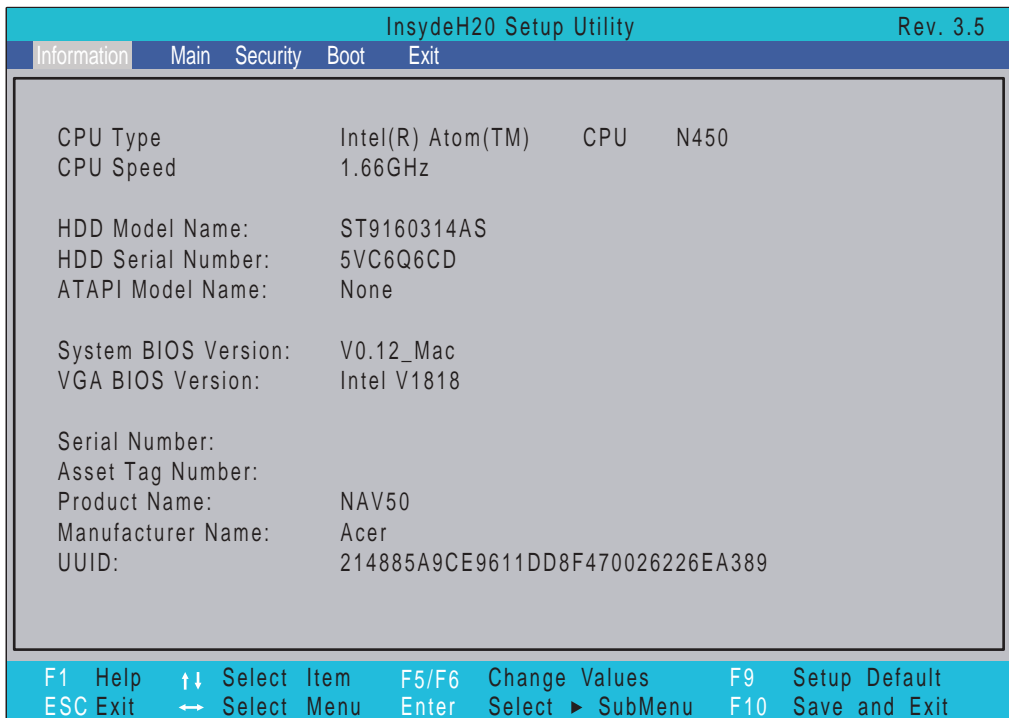

**NOTE:** The system information is subject to different models.

| Parameter           | Description  |
|---------------------|--|
| CPU Type            | This field shows the CPU type and speed of the system.   |
| CPU Speed           | This field shows the speed of the CPU.   |
| HDD Model Name      | This field shows the model name of HDD installed on primary IDE master.  |
| HDD Serial Number   | This field displays the serial number of HDD installed on primary IDE master.  |
| ATAPI Model Name    | This field displays the ATAPI Model Name.  |
| System BIOS Version | This field displays the system BIOS version.   |
| VGA BIOS Version    | This field displays the VGA firmware version of the system.  |
| Serial Number       | This field displays the serial number of this unit.  |
| Asset Tag Number    | This field displays the asset tag number of the system.  |
| Product Name        | This field shows product name of the system.   |
| Manufacturer Name   | This field displays the manufacturer of this system.   |
| UUID                | Universally Unique Identifier (UUID) is an identifier standard used in software construction, standardized by the Open Software Foundation (OSF) as part of the Distributed Computing Environment (DCE). |



# Main

The Main screen allows the user to set the system time and date as well as enable and disable boot option and recovery.

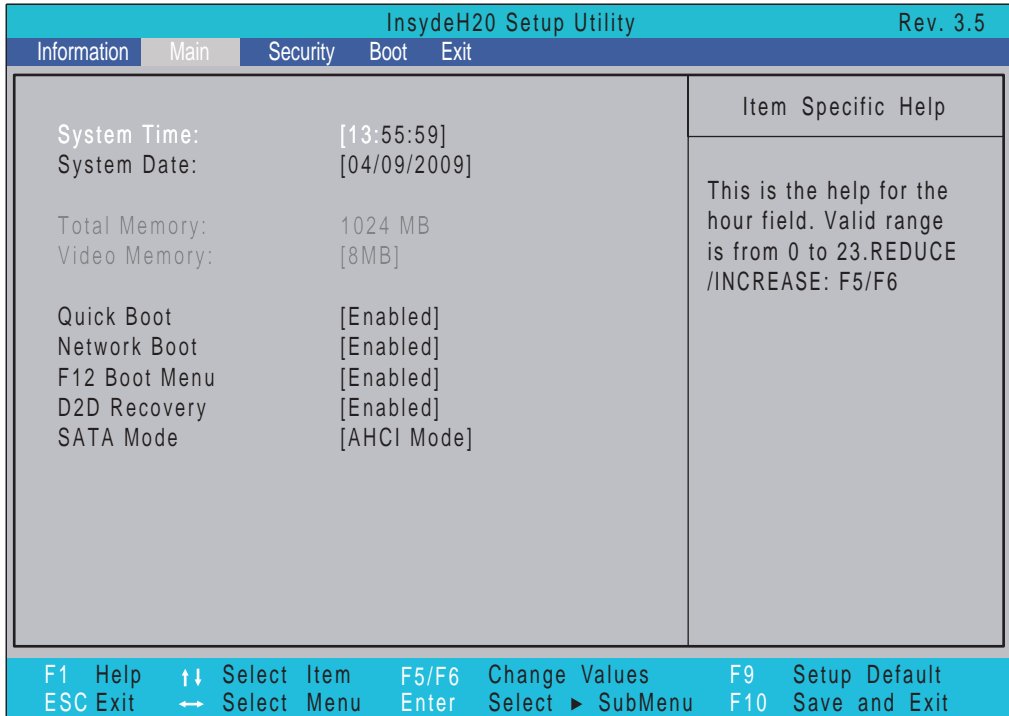

**NOTE:** The screen above is for your reference only. Actual values may differ.

The table below describes the parameters in this screen. Settings in **boldface** are the default and suggested parameter settings.

| Parameter     | Description   | Format/Option                         |
|---------------|---|---------------------------------------|
| System Time   | Sets the system time. The hours are displayed with 24-hour format.  | Format: HH:MM:SS (hour:minute:second) |
| System Date   | Sets the system date.   | Format MM/DD/YYYY (month/day/year)    |
| Total Memory  | This field reports the memory size of the system. Memory size is fixed to 3017 MB.  | N/A                                   |
| Video Memory  | Shows the video memory size. VGA Memory size=32 MB  | N/A                                   |
| Quick Boot    | Allows startup to skip certain tests while booting, decreasing the time needed to boot the system.  | Option: <b>Enabled</b> or Disabled    |
| Network Boot  | Enables, disables the system boot from LAN (remote server).   | Option: <b>Enabled</b> or Disabled    |
| F12 Boot Menu | Enables, disables Boot Menu during POST.  | Option: <b>Enabled</b> or Disabled    |
| D2D Recovery  | Enables, disables D2D Recovery function. The function allows the user to create a hidden partition on hard disc drive to store operation system and restore the system to factory defaults. | Option: <b>Enabled</b> or Disabled    |
| SATA Mode     | Control the mode in which the SATA controller should operate.   | Option: <b>AHCI</b> or IDE            |

# Security

The Security screen contains parameters that help safeguard and protect your computer from unauthorized use.

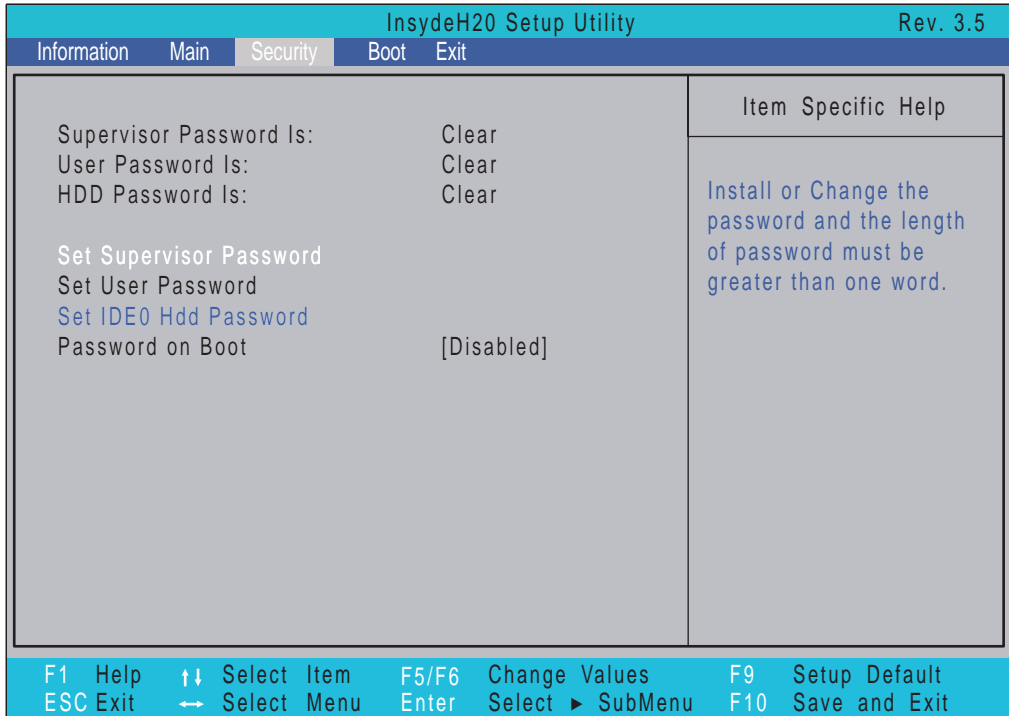

The table below describes the parameters in this screen. Settings in **boldface** are the default and suggested parameter settings.

| Parameter               | Description  | Option                     |
|-------------------------|--|----------------------------|
| Supervisor Password Is  | Shows the setting of the Supervisor password   | <b>Clear</b> or Set        |
| User Password Is        | Shows the setting of the user password.  | <b>Clear</b> or Set        |
| HDD Password IS         | Shows the setting of the HDD password  | <b>Clear</b> or Set        |
| Set Supervisor Password | Press Enter to set the supervisor password. When set, this password protects the BIOS Setup Utility from unauthorized access. The user can not either enter the Setup menu nor change the value of parameters.                                       |                            |
| Set User Password       | Press Enter to set the user password. When user password is set, this password protects the BIOS Setup Utility from unauthorized access. The user can enter Setup menu only and does not have right to change the value of parameters.               |                            |
| Set Hdd Password        | Enter HDD password.  |                            |
| Password on Boot        | Defines whether a password is required or not while the events defined in this group happened. The following sub-options are all requires the Supervisor password for changes and should be grayed out if the user password was used to enter setup. | Enabled or <b>Disabled</b> |

**NOTE:** When you are prompted to enter a password, you have three tries before the system halts. Don't forget your password. If you forget your password, you may have to return your notebook computer to your dealer to reset it.

---

## Setting a Password

Follow these steps as you set the user or the supervisor password:

1. Use the ↑ and ↓ keys to highlight the Set Supervisor Password parameter and press the **Enter** key. The Set Supervisor Password box appears:

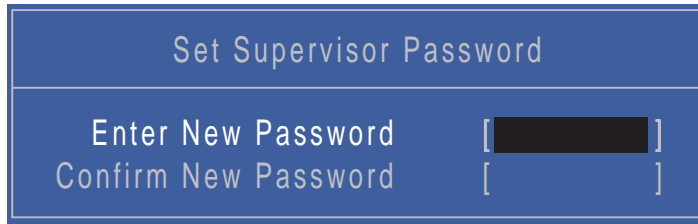

The screenshot shows a blue BIOS screen titled "Set Supervisor Password". Below the title, there are two input fields: "Enter New Password" and "Confirm New Password". The "Enter New Password" field contains a blacked-out password, and the "Confirm New Password" field is empty.

2. Type a password in the "Enter New Password" field. The password length can not exceed 8 alphanumeric characters (A-Z, a-z, 0-9, not case sensitive). Retype the password in the "Confirm New Password" field.

**IMPORTANT:** Be very careful when typing your password because the characters do not appear on the screen.

3. Press **Enter**. After setting the password, the computer sets the User Password parameter to "Set".
4. If desired, you can opt to enable the Password on boot parameter.
5. When you are done, press F10 to save the changes and exit the BIOS Setup Utility.

## Removing a Password

Follow these steps:

1. Use the ↑ and ↓ keys to highlight the Set Supervisor Password parameter and press the **Enter** key. The Set Password box appears:



The screenshot shows a blue BIOS screen titled "Set Supervisor Password". Below the title, there are three input fields: "Enter Current Password", "Enter New Password", and "Confirm New Password". The "Enter Current Password" field contains a blacked-out password, while the other two fields are empty.

2. Type the current password in the Enter Current Password field and press **Enter**.
3. Press **Enter** twice **without** typing anything in the Enter New Password and Confirm New Password fields. The computer then sets the Supervisor Password parameter to "Clear".
4. When you have changed the settings, press u to save the changes and exit the BIOS Setup Utility.

---

## Changing a Password

1. Use the ↑ and ↓ keys to highlight the Set Supervisor Password parameter and press the **Enter** key. The Set Password box appears.

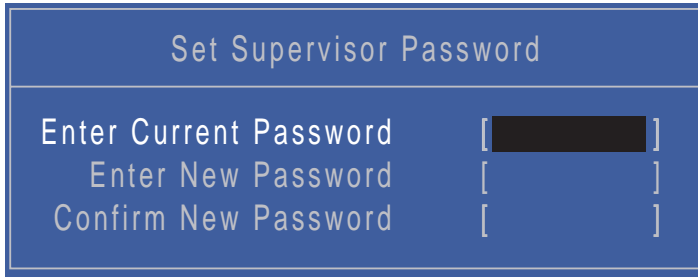

The screenshot shows a blue BIOS screen titled "Set Supervisor Password". It contains three input fields: "Enter Current Password", "Enter New Password", and "Confirm New Password". The "Enter Current Password" field is filled with blacked-out characters, while the other two fields are empty.

2. Type the current password in the Enter Current Password field and press **Enter**.
3. Type a password in the Enter New Password field. Retype the password in the Confirm New Password field.
4. Press **Enter**. After setting the password, the computer sets the User Password parameter to "Set".
5. If desired, you can enable the Password on boot parameter.
6. When you are done, press **F10** to save the changes and exit the BIOS Setup Utility.

If the verification is OK, the screen will display as following.



The screenshot shows a white BIOS screen titled "Setup Notice". The text "Changes have been saved." is displayed in the center. At the bottom, there is a black button labeled "Continue".

The password setting is complete after the user presses **Enter**.

If the current password entered does not match the actual current password, the screen will show you the Setup Warning.



The screenshot shows a white BIOS screen titled "Setup Warning" in red text. Below the title, the text "Invalid Password." is displayed in red. At the bottom, there is a black button labeled "Continue".

If the new password and confirm new password strings do not match, the screen displays the following message.



The screenshot shows a white BIOS screen titled "Setup Warning" in red text. Below the title, the text "Passwords do not match. Re-enter password." is displayed in red. At the bottom, there is a black button labeled "Continue".

# Boot

This menu allows the user to decide the order of boot devices to load the operating system. Bootable devices includes the USB diskette drives, the onboard hard disk drive and the DVD drive in the module bay.

| InsydeH20 Setup Utility |                |                        |   | Rev. 3.5 |
|-------------------------|----------------|------------------------|---|----------|
| Information             | Main           | Security               | Boot  | Exit     |
| Boot priority order:    |                |                        | Item Specific Help  |          |
| 1. IDE0 : ST9160314AS   |                |                        | Use <↑> or <↓> to select a device, then press <F5> to move it down the list, or <F6> to move it up the list. Press <Esc> to escape the menu |          |
| 2. IDE1 :               |                |                        |   |          |
| 3. USB FDD :            |                |                        |   |          |
| 4. Network Boot : LAN   |                |                        |   |          |
| 5. USB HDD :            |                |                        |   |          |
| 6. USB CDROM :          |                |                        |   |          |
| F1 Help                 | ↑↓ Select Item | F5/F6 Change Values    | F9 Setup Default  |          |
| ESC Exit                | ←→ Select Menu | Enter Select ► SubMenu | F10 Save and Exit   |          |

# Exit

The Exit screen allows you to save or discard any changes you made and quit the BIOS Utility.

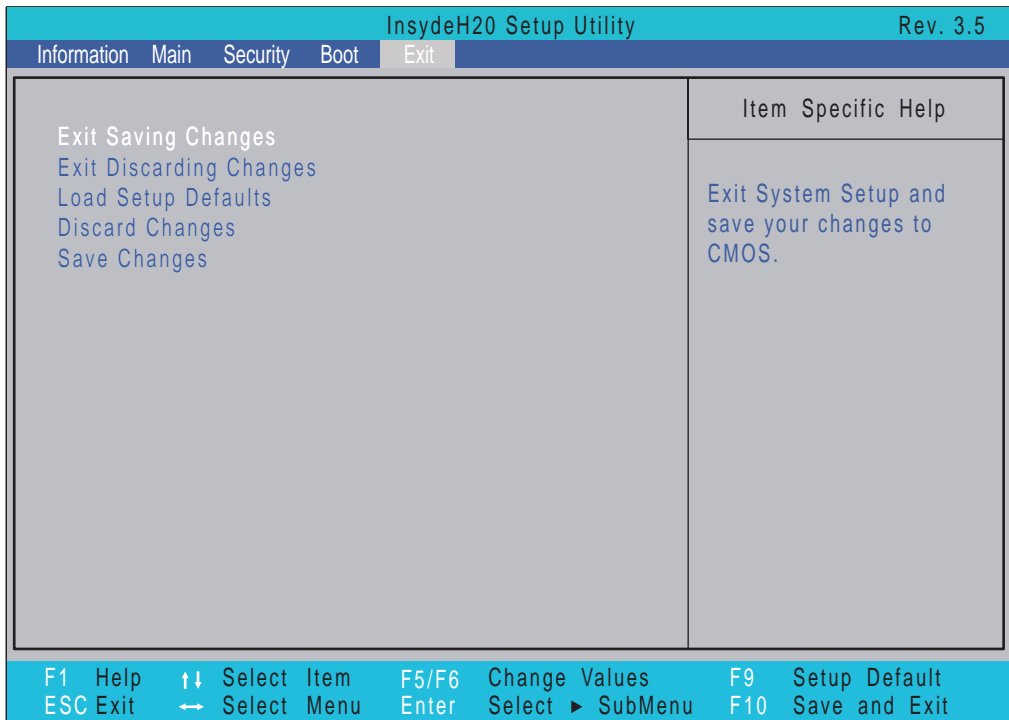

The table below describes the parameters in this screen.

| Parameter               | Description   |
|-------------------------|---|
| Exit Saving Changes     | Exit System Setup and save your changes to CMOS.    |
| Exit Discarding Changes | Exit utility without saving setup data to CMOS.     |
| Load Setup Default      | Load default values for all SETUP item.             |
| Discard Changes         | Load previous values from CMOS for all SETUP items. |
| Save Changes            | Save Setup Data to CMOS.                            |

---

# BIOS Flash Utility

The BIOS flash memory update is required for the following conditions:

- New versions of system programs
- New features or options
- Restore a BIOS when it becomes corrupted.

Use the Flash utility to update the system BIOS flash ROM.

**NOTE:** If you do not have a crisis recovery diskette at hand, then you should create a **Crisis Recovery Diskette** before you use the Flash utility.

**NOTE:** Do not install memory-related drivers (XMS, EMS, DPMI) when you use the Flash utility.

**NOTE:** Please use the AC adaptor power supply when you run the Flash utility. If the battery pack does not contain enough power to finish BIOS flash, you may not boot the system because the BIOS is not completely loaded.

Follow the steps below to run the Flash utility.

1. Prepare a bootable diskette.
2. Copy the flash utilities to the bootable diskette.
3. Then boot the system from the bootable diskette. The flash utility has auto-execution function.

# DOS Flash Utility

Perform the following steps to use the DOS Flash Utility:

1. Press F2 during boot to enter the Setup Menu.
2. Select **Boot Menu** to modify the boot priority order, for example, if using USB HDD to Update BIOS, move USB HDD to position 1.

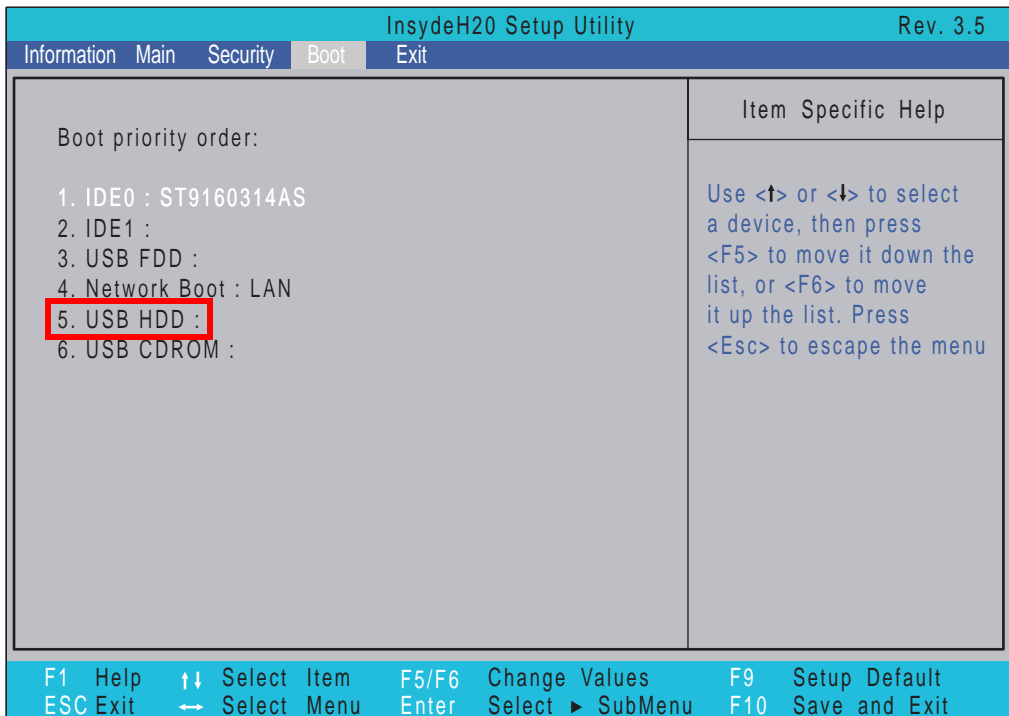

3. Execute the **IFLASH.BAT** batch file to update BIOS.

The flash process begins as shown.



4. In flash BIOS, the message **Please do not remove AC Power Source** displays.



---

**NOTE:** If the AC power is not connected, the following message displays.

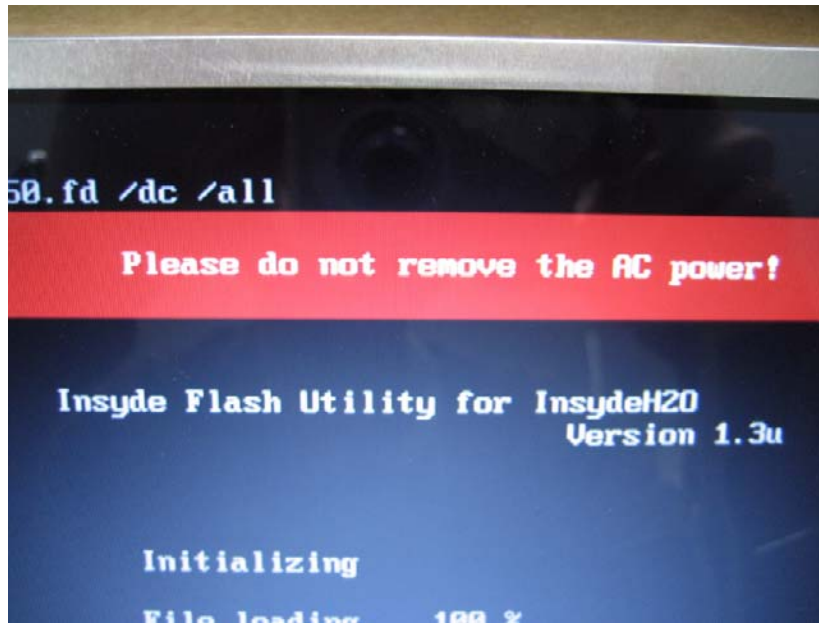

Plug in the AC power to continue.

5. Flash is complete when the message Flash programming complete displays.

---

## WinFlash Utility

Perform the following steps to use the WinFlash Utility:

1. Double click the WinFlash executable.
2. Click **OK** to begin the update. A progress screen displays.

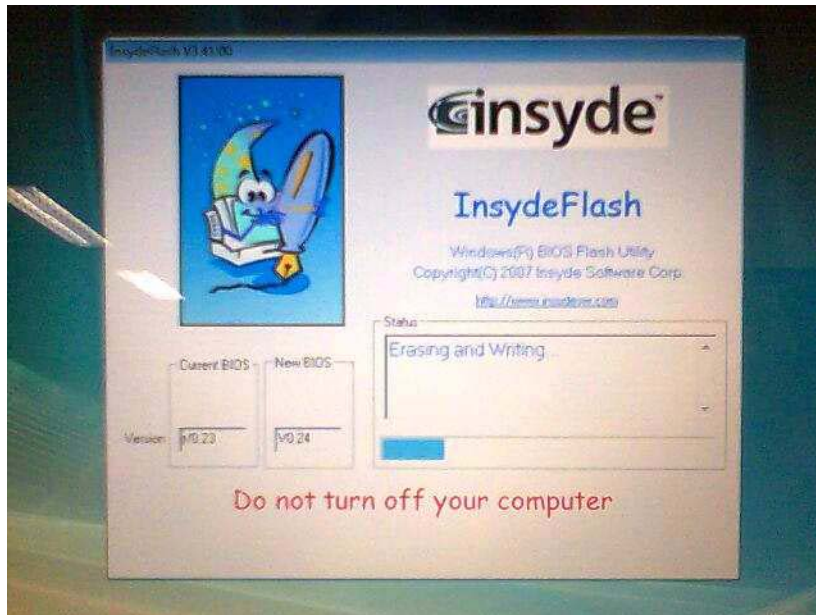

3. When the process is complete, close all programs and applications and reboot the system.

---

# Remove HDD/BIOS Password Utilities

This section provides you with details about removing HDD/BIOS password methods:

## Removing HDD Password:

If you key in the wrong HDD password three times, an error is generated.

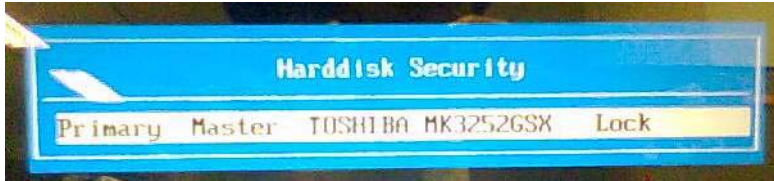

To reset the HDD password, perform the following steps:

1. After the error is displayed, select the **Enter Unlock Password** option on the screen.

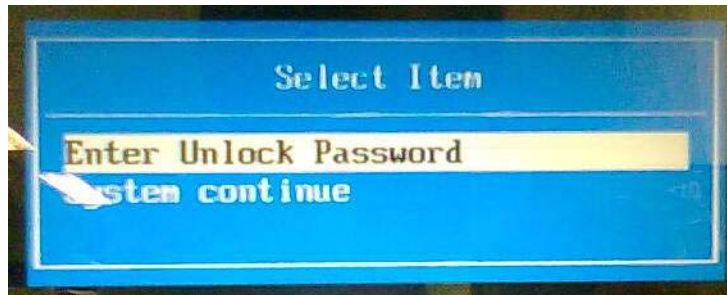

2. An Encode key is generated for unlocking utilities. Note down this key.

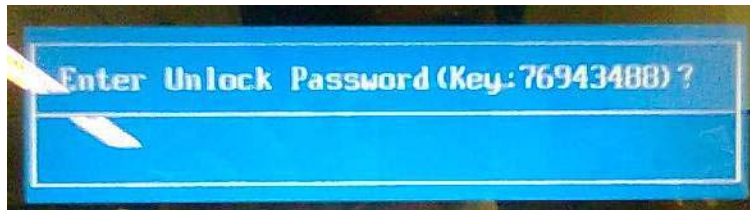

3. Execute the **UnlockHD.EXE** file to create the unlock code in DOS Mode using the format **UnlockHD [Encode key]** with the code noted in the previous step, as follows:

```
UnlockHD 76943488
```

4. The command generates a password which can be used for unlocking the HDD.

```
Password : 46548274
```

5. Key in the password from the previous step to unlock the HDD as shown.

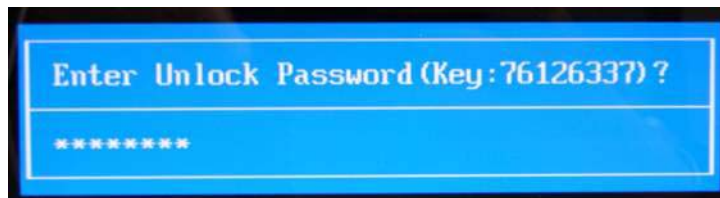

---

### Removing BIOS Passwords:

To clear the User or Supervisor passwords, open the RAM door and use a metal instrument to short the **U72** jumper as shown below.

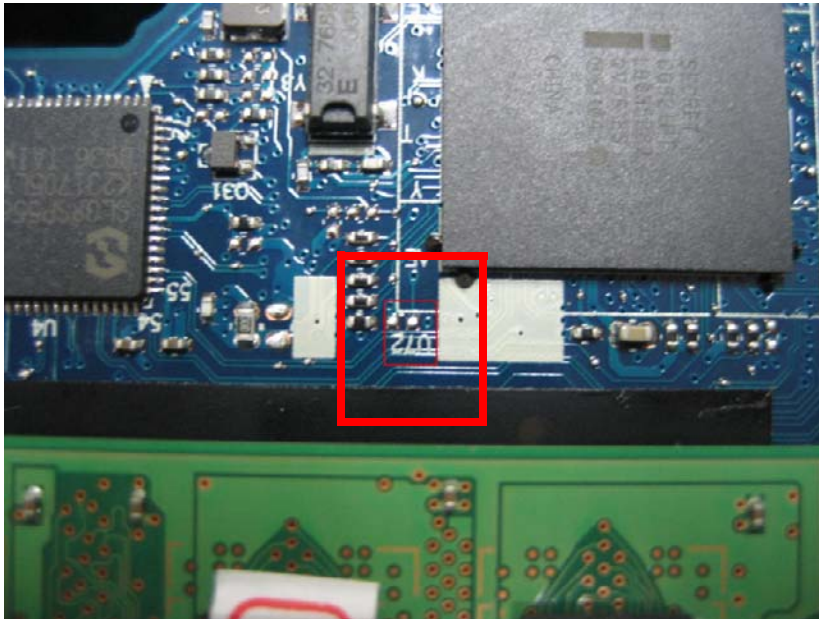

### Cleaning BIOS Passwords

To clean the User or Supervisor passwords, perform the following steps:

1. From a DOS prompt, execute **clnpwd.exe**
2. Press **1** or **2** to clean the desired password shown on the screen.

```
d:\Clnpwd>clnpwd
ACER Clean Password Utility V1.00
Press 1 or 2 to clean any password shown as below
    1.User Password
    2.Supervisor Password

Clean User Password Successfully!
```

The onscreen message determines whether the function is successful or not.

---

## Miscellaneous Utilities

### Using Boot Sequence Selector

Boot Sequence Selector allows the boot order to be changes without accessing the BIOS. To use Boot Sequence Selector, perform the following steps:

1. Enter into DOS.
2. Execute BS.exe to display the usage screen.

```
d:\BOOTSEQ>bs

*** Boot Sequence Selector Version 0.03 ***
Create by Rockwell Chuang 10/01/2005.

Usage:
      BS [ 1 | 2 | 3 | 4 ]

BS 1 : [ Floppy ] => [ HardDisk ] => [ CD-ROM ] => [ LAN   ]
BS 2 : [ HardDisk ] => [ CD-ROM ] => [ LAN   ] => [ Floppy ]
BS 3 : [ CD-ROM ] => [ HardDisk ] => [ LAN   ] => [ Floppy ]
BS 4 : [ LAN   ] => [ Floppy ] => [ HardDisk ] => [ CD-ROM ]

d:\BOOTSEQ>
```

3. Select the desired boot sequence by entering the corresponding sequence, for example, enter BS2 to change the boot sequence to HDD|CD ROM|LAN|Floppy.

### Using DMITools

The DMI (Desktop Management Interface) Tool copies BIOS information to eeprom to be used in the DMI pool for hardware management.

When the BIOS displays **Verifying DMI pool data** it is checking the table correlates with the hardware before sending to the operating system (Windows, etc.).

To update the DMI Pool, perform the following steps:

1. Enter into DOS.
2. Execute **dmitools.exe**. The following messages show dmitools usage:  
DMITools [ /R | /WP | /WS | /WU ] [ STRING ]
  - dmitools /r ==> Read dmi string from bios
  - dmitools /wm xxxx ==> Write manufacturer name to eeprom
  - dmitools /wp xxxx ==> Write product name to eeprom
  - dmitools /ws xxxx ==> Write serial number to eeprom
  - dmitools /wu xxxx ==> Write uuid to eeprom
  - dmitools /wa xxxx ==> Write asset tag to eeprom

**IMPORTANT:**The following write examples (2 to 5) require a system reboot to take effect

---

### Example 1: Read DMI Information from Memory

Input:

```
dmitools /r
```

Output:

```
Manufacturer (Type1, Offset04h): Acer  
Product Name (Type1, Offset05h): Aspire one xxxxx  
Serial Number (Type1, Offset07h): 01234567890123456789  
UUID String (Type1, Offset08h): xxxxxxxx-xxxx-xxxx-xxxx-xxxxxxxxxxxx  
Asset Tag (Type3, Offset04h): Acer Asstag
```

### Example 2: Write Product Name to EEPROM

Input:

```
dmitools /wp Acer
```

### Example 3: Write Serial Number to EEPROM

Input:

```
dmitools /ws 01234567890123456789
```

### Example 4: Write UUID to EEPROM (Create UUID from Intel WFM20.pdf)

Input:

```
dmitools /wu
```

### Example 5: Write Asset Tag to EEPROM

Input:

```
dmitools /wa Acer Asstag
```

## Using the LAN MAC Utility

Perform the following steps to write MAC information to eeprom:

1. Use a text editor, for example Notepad, to edit the MAC.CFG file as shown:



```
MAC.CFG - 記事本  
檔案(F) 編輯(E) 格式(O) 檢視(V) 說明(H)  
Title= MAC Address byte  
WriteData='001122334455'  
StartAddr=7A  
WriteLeng=6  
KeepByte=0
```

- WriteData= '001122334455' <----- MAC value
- StartAddr=7A <----- MAC address
- WriteLeng=6 <----- MAC value length
- KeepByte=0 <----- can be any value

2. Boot into DOS.

- 
3. Execute **MAC.BAT** to write MAC information to eeprom.

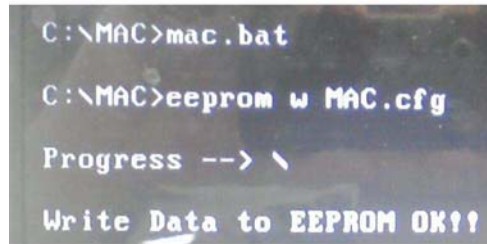

```
C:\MAC>mac.bat  
C:\MAC>eeprom w MAC.cfg  
Progress --> \  
Write Data to EEPROM OK!!
```





# Machine Disassembly and Replacement

---

This chapter contains step-by-step procedures on how to disassemble the notebook computer for maintenance and troubleshooting.

## Disassembly Requirements

To disassemble the computer, you need the following tools:

- Wrist grounding strap and conductive mat for preventing electrostatic discharge
- Flat screwdriver
- Philips screwdriver
- Plastic flat screwdriver
- Plastic tweezers

**NOTE:** The screws for the different components vary in size. During the disassembly process, group the screws with the corresponding components to avoid mismatch when putting back the components.

## Related Information

The product previews seen in the disassembly procedures may not represent the final product color or configuration.

**IMPORTANT:** Cable paths and positioning may not represent the actual model. During the removal and replacement of components, ensure all available cable channels and clips are used and that the cables are replaced in the same position.

---

# General Information

## Pre-disassembly Instructions

Before proceeding with the disassembly procedure, make sure that you do the following:

1. Turn off the power to the system and all peripherals.
2. Unplug the AC adapter and all power and signal cables from the system.



3. Place the system on a flat, stable surface.
4. Remove the battery pack.

## Disassembly Process

The disassembly process is divided into the following sections:

- External components disassembly
- Main unit disassembly
- LCD module disassembly

The flowcharts provided in the succeeding disassembly sections illustrate the entire disassembly sequence. Observe the order of the sequence to avoid damage to any of the hardware components. For example, if you want to remove the Mainboard, you must first remove the Keyboard, and LCD Module then disassemble the inside assembly frame in that order.

### Main Screw List

| Screw          | Quantity | Part Number  |
|----------------|----------|--------------|
| M2*3 ZK NL     | 18       | 86.SAS02.001 |
| M2*4 ZK NL CR3 | 17       | 86.SAS02.002 |
| M2*6 ZK NL CR3 | 12       | 86.SAS02.004 |
| M3*3 NI        | 4        | 86.SAS02.006 |

# External Module Disassembly Process

**NOTE:** The product previews seen in the disassembly procedures may not represent the final product color or configuration.

## External Modules Disassembly Flowchart

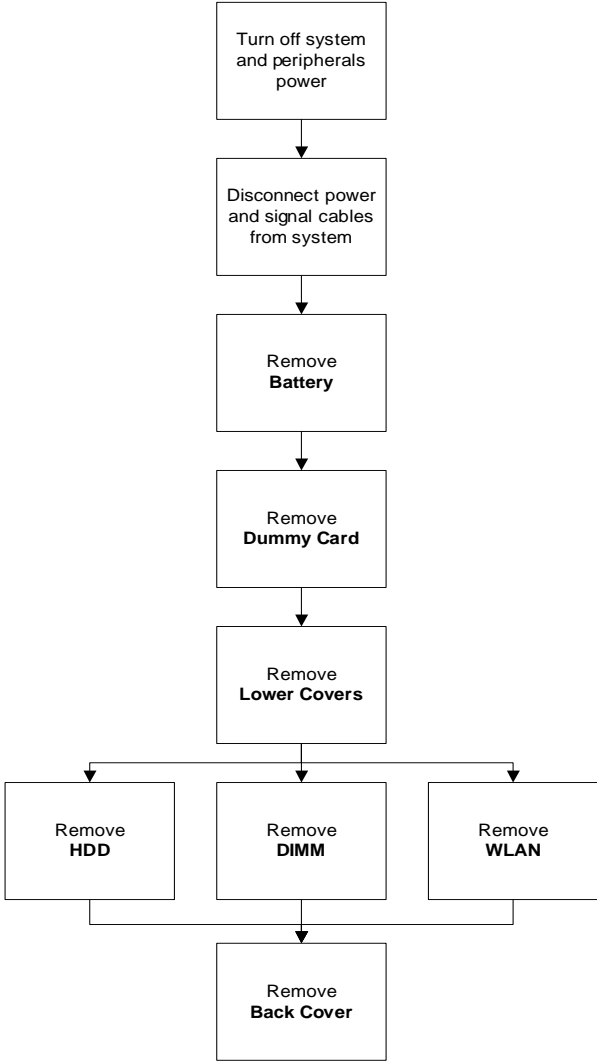

**Screw List**

| Step        | Screw | Quantity | Part No.     |
|-------------|-------|----------|--------------|
| HDD Door    | M2*4  | 3        | 86.SAS02.002 |
| HDD Carrier | M3*3  | 4        | 86.SAS02.006 |
| WLAN Module | M2*3  | 1        | 86.SAS02.001 |
| DIMM Door   | M2*6  | 1        | 86.SAS02.004 |
| Back Cover  | M2*3  | 2        | 86.SAS02.001 |
|             | M2*4  | 5        | 86.SAS02.002 |
|             | M2*6  | 4        | 86.SAS02.004 |

---

## Removing the Battery Pack

1. Turn the computer over.
2. Slide the battery lock/unlock latch to the unlock position.





3. Slide and hold the battery release latch to the release position (1), then slide out the battery pack from the main unit (2).

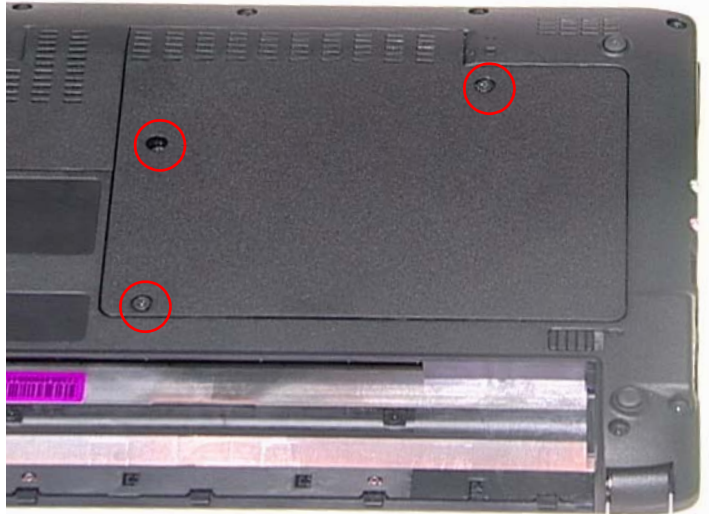

# Removing the HDD Module

1. Remove the three (3) screws from the HDD Cover.



| Step      | Size | Quantity | Screw Type  |
|-----------|------|----------|---|
| HDD Cover | M2*4 | 3        |  |

2. Lift the HDD cover up to remove.



3. Slide the HDD in the direction of the arrow to disconnect the HDD from the interface connector.

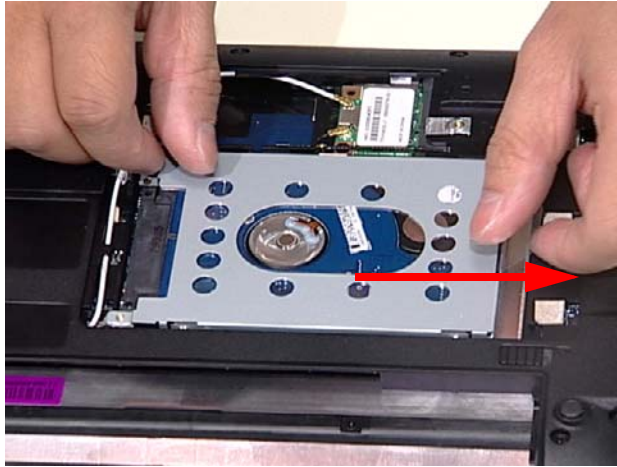

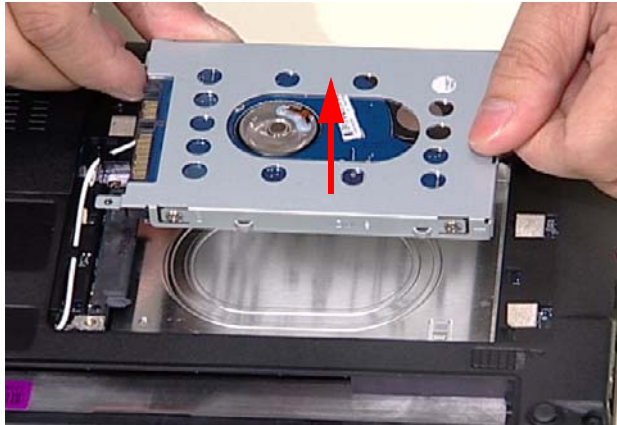

4. Lift the hard disk drive module out of the bay.

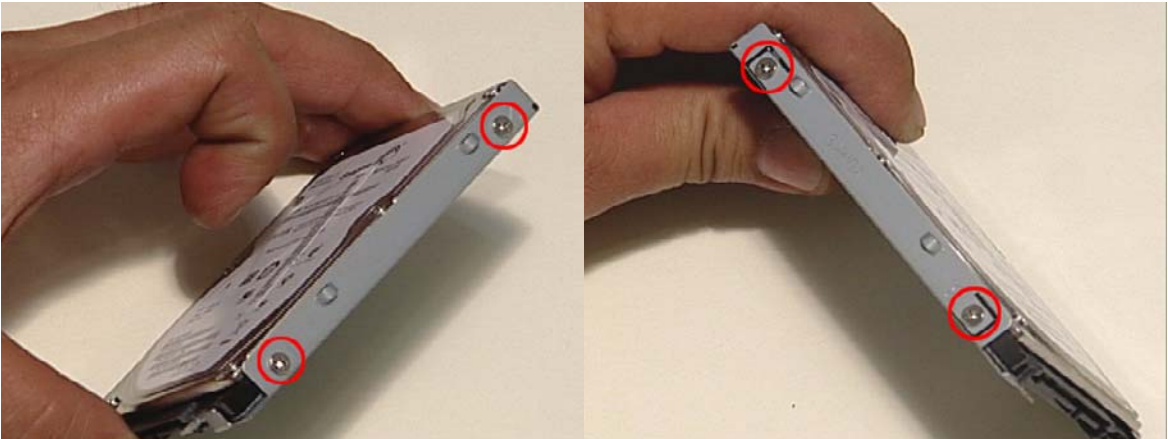

**NOTE:** To prevent damage to the device, avoid pressing down on it or placing heavy objects on top of it.

5. Remove the four (4) screws (two each side) securing the hard disk to the carrier.



| Step        | Size | Quantity | Screw Type  |
|-------------|------|----------|---|
| HDD Carrier | M3*3 | 4        |  |

6. Remove the HDD from the carrier.

---

## Removing the DIMM Module

1. Remove one (1) screw from the DIMM door.

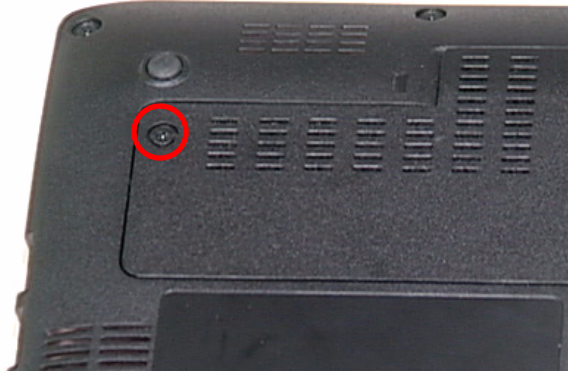

2. Insert a plastic tool to lift the corner of the DIMM cover.



3. Lift the DIMM cover clear of the device.

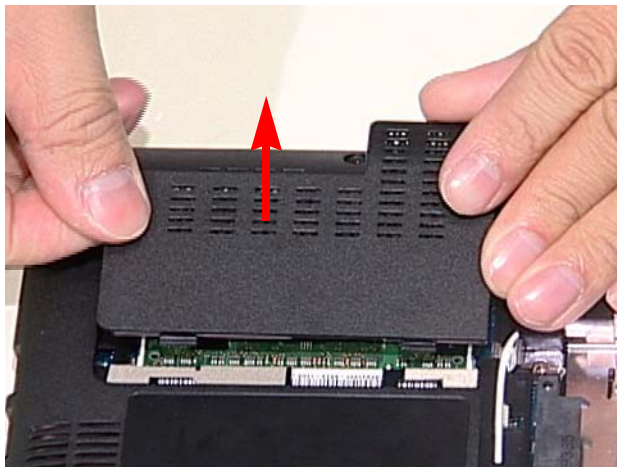

---

4. Push out the release latches on both sides of the DIMM socket to release the DIMM module.

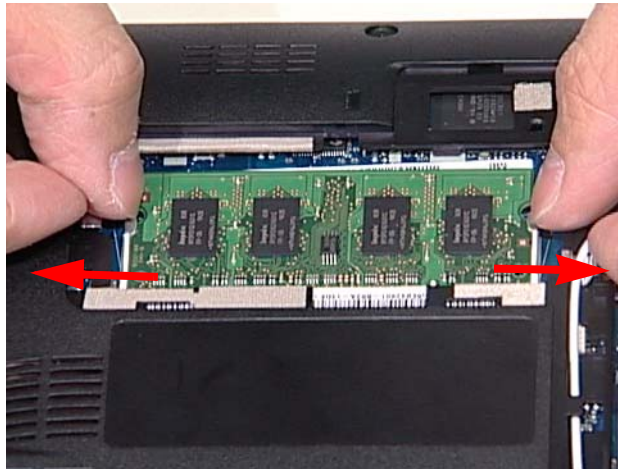

5. Remove the DIMM module.

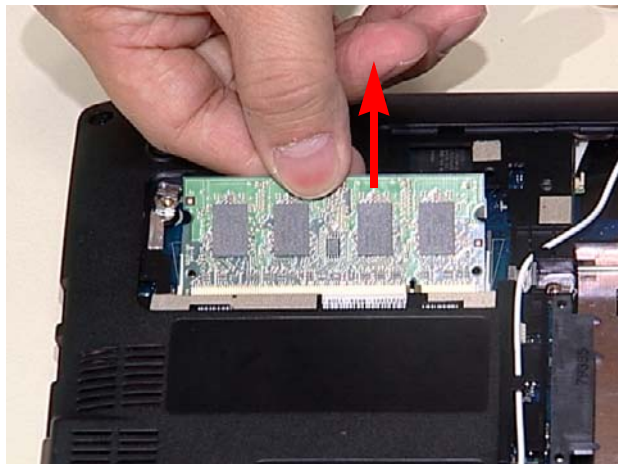



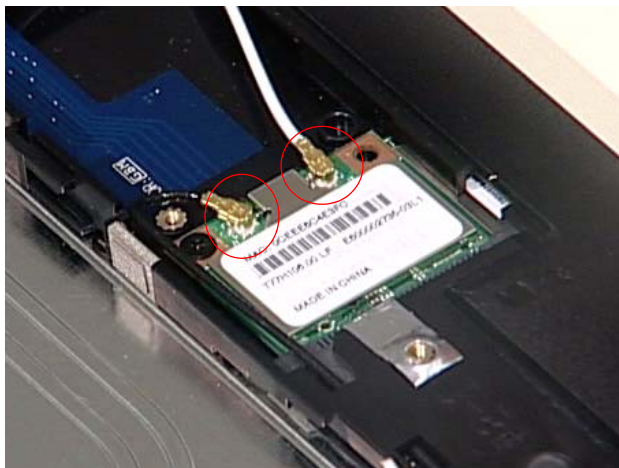

## Removing the WLAN Module

1. See "Removing the HDD Module" on page 43.
2. Disconnect the Antenna cables from the WLAN Module.

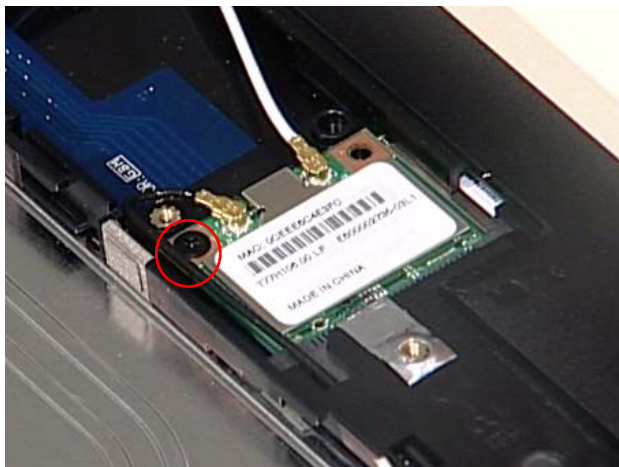

3. Move the antenna away and remove the one (1) screw from the WLAN Module.



| Step        | Size | Quantity | Screw Type  |
|-------------|------|----------|---|
| WLAN Module | M2*3 | 1        |  |

---

4. Pull the WLAN Module from the slot.

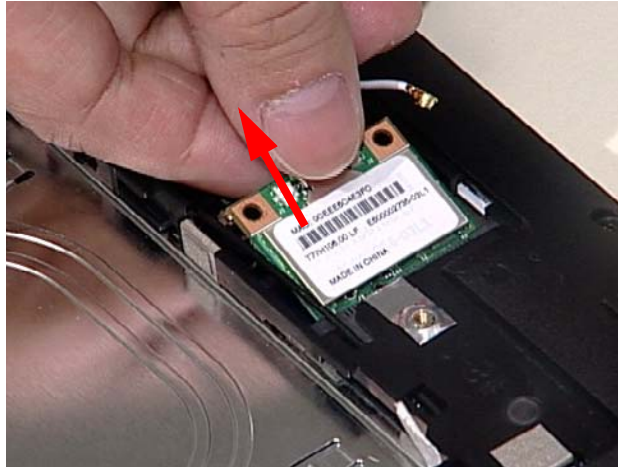



**NOTE:** When reattaching the antennas, ensure the cables are tucked into the chassis to prevent damage.

## Removing the Back Cover

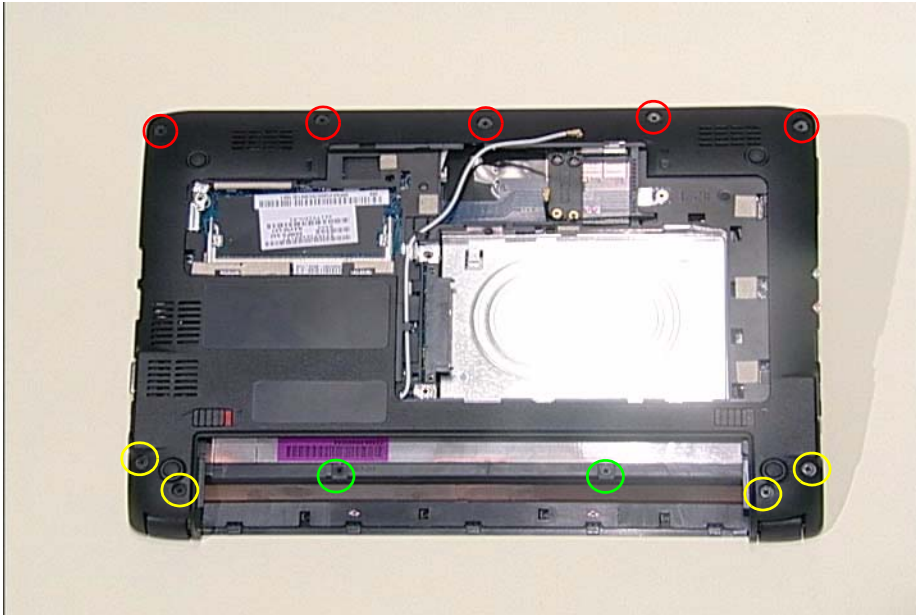
1. See "Removing the HDD Module" on page 43.
2. See "Removing the DIMM Module" on page 45.
3. See "Removing the WLAN Module" on page 47.
4. Remove eleven (11) screws from the Back Cover.



| Step                           | Size | Quantity | Screw Type  |
|--------------------------------|------|----------|---|
| Back Cover<br>(Green Callout)  | M2*3 | 2        |  |
| Back Cover<br>(Red Callout)    | M2*4 | 5        |  |
| Back Cover<br>(Yellow Callout) | M2*6 | 4        |  |

# Main Unit Disassembly Process

**IMPORTANT:** Cable paths and positioning may not represent the actual model. During the removal and replacement of components, ensure all available cable channels and clips are used and that the cables are replaced in the same position.

**NOTE:** The product previews seen in the disassembly procedures may not represent the final product color or configuration.

## Main Unit Disassembly Flowchart

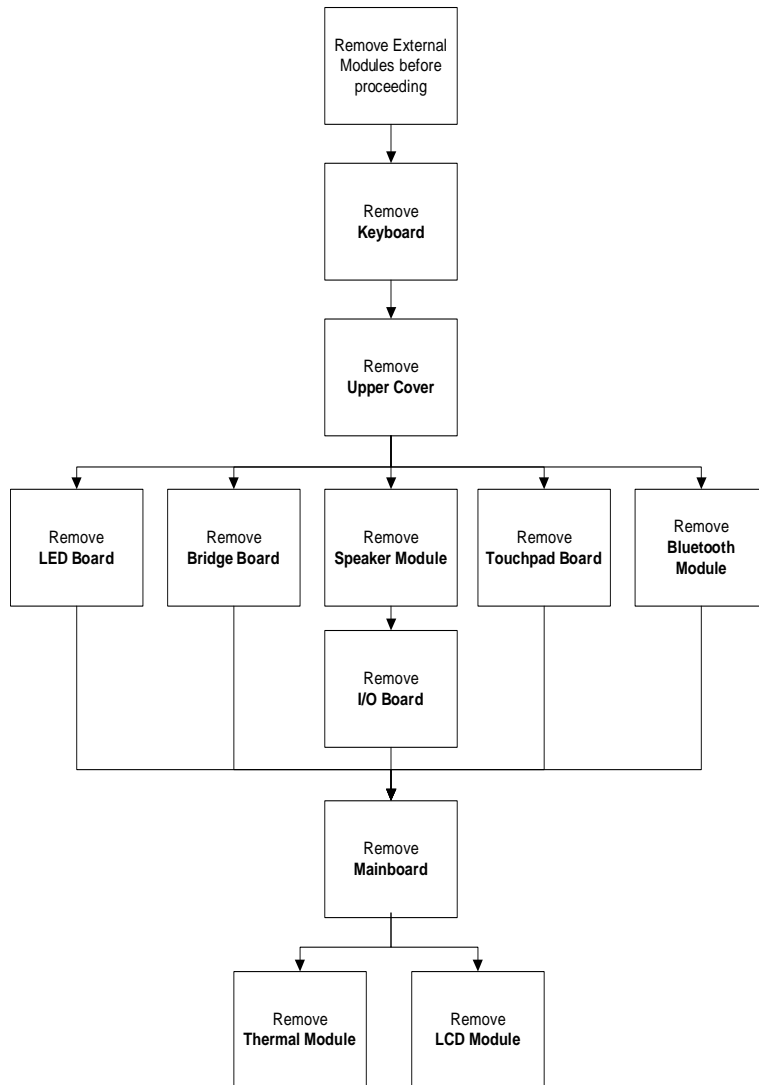

### Screw List

| Step           | Screw | Quantity | Part No.     |
|----------------|-------|----------|--------------|
| Upper Cover    | M2*6  | 7        | 86.SAS02.004 |
| LED Board      | M2*3  | 1        | 86.SAS02.001 |
| Bridge Board   | M2*3  | 2        | 86.SAS02.001 |
| Speaker Module | M2*3  | 4        | 86.SAS02.001 |
| Touchpad Board | M2*3  | 2        | 86.SAS02.001 |

---

| Step           | Screw | Quantity | Part No.     |
|----------------|-------|----------|--------------|
| I/O Board      | M2*3  | 1        | 86.SAS02.001 |
| Mainboard      | M2*3  | 1        | 86.SAS02.001 |
| Thermal Module | M2*4  | 3        | 86.SAS02.002 |

---

## Removing the Keyboard

1. See "Removing the Battery Pack" on page 42.
2. Turn the computer rightside up and open the lid to the full extent.
3. Unlock the center securing latch by pressing down with a plastic tool.

**IMPORTANT:** The use of metal tools may damage the outer casing. Use only plastic tools.



4. Grasp the Keyboard and lift upward in the center as shown.



5. Turn the Keyboard over and open Keyboard FPC securing latch.

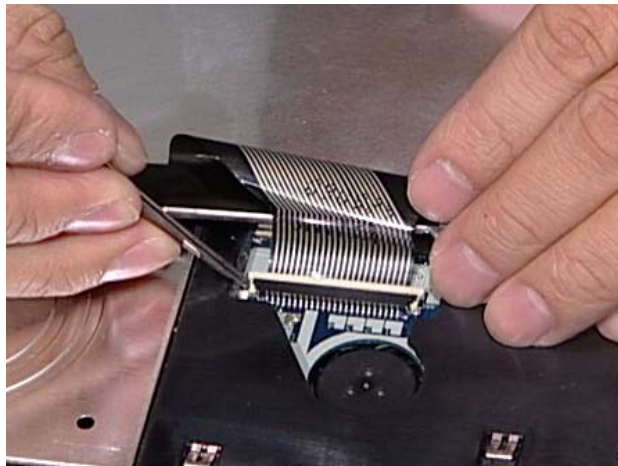

6. Disconnect the FFC and lift the Keyboard clear of the device.

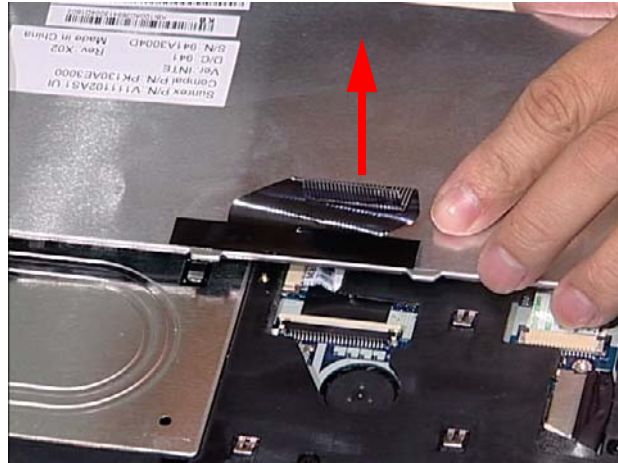

## Removing the Upper Cover

1. See "Removing the Keyboard" on page 52.
2. Disconnect the following cables from the Mainboard.

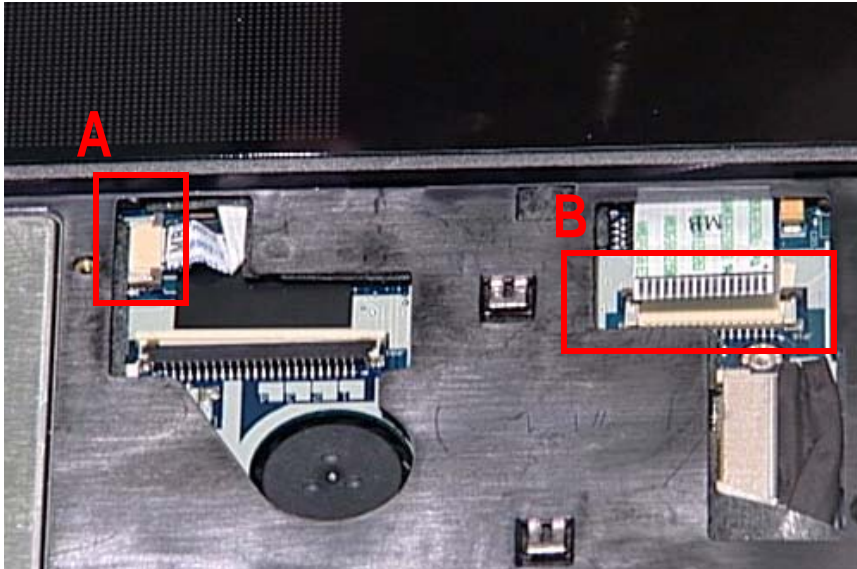

Release the locking latch on A as shown.

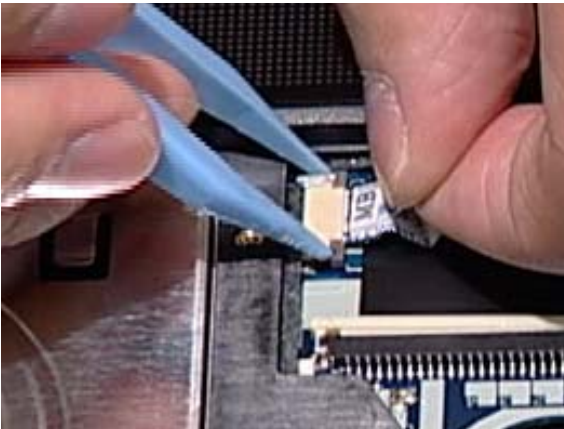

Disconnect A from the Mainboard.

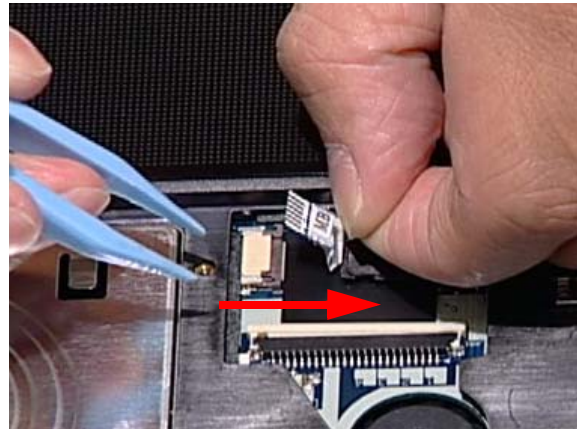

Release the locking latch on B as shown.

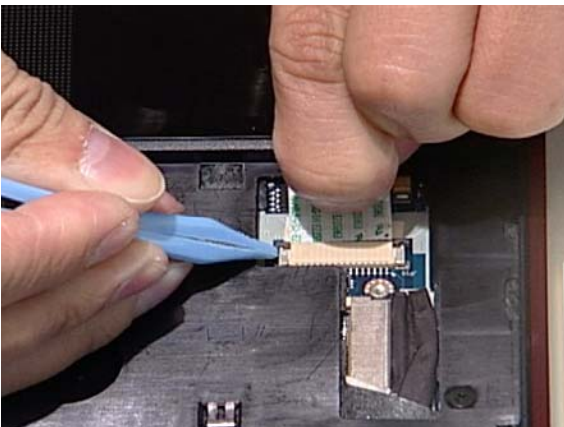

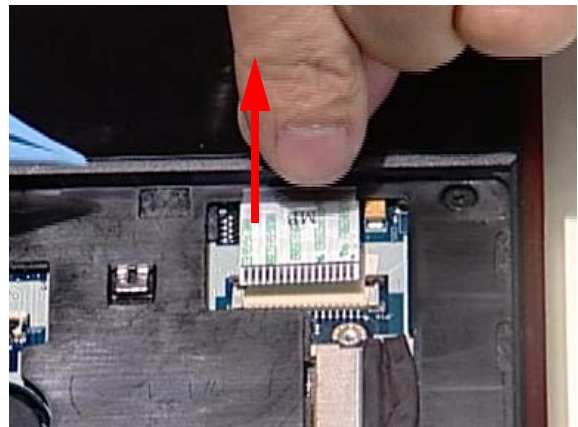

Disconnect B from the Mainboard.



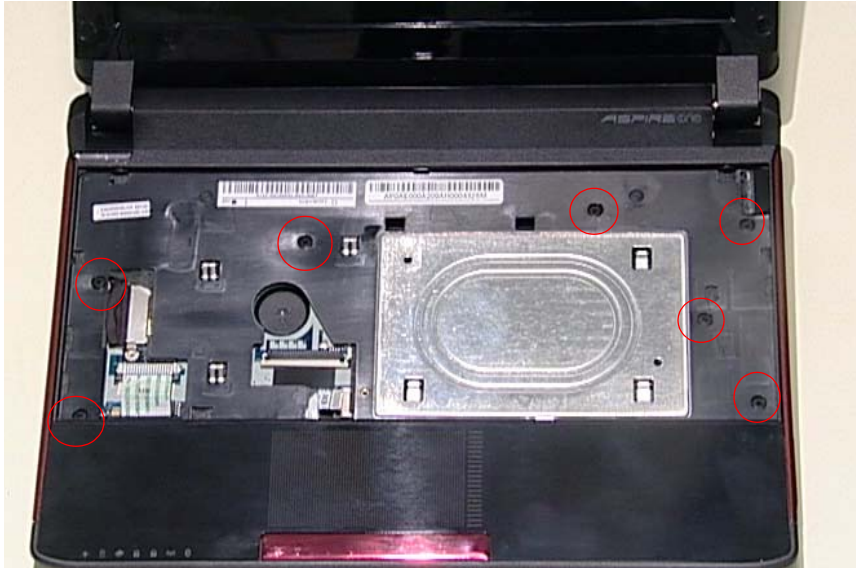

3. Turn the computer over. Remove the seven (7) securing screws.



| Step        | Size | Quantity | Screw Type  |
|-------------|------|----------|---|
| Upper Cover | M2*6 | 7        |  |

4. Slide a plastic tool between the Upper and Lower Covers to unlock the guide hooks underneath.

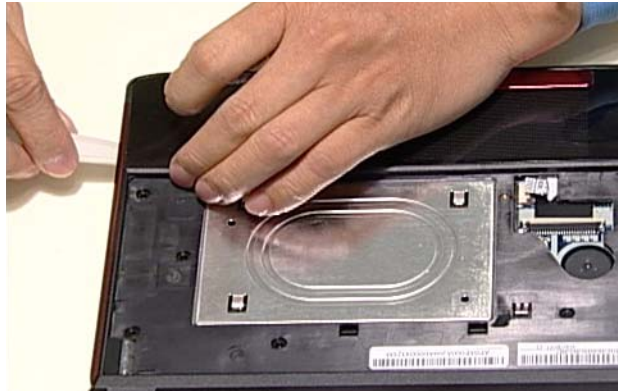

5. Grasp the right side of the upper cover and pry apart.

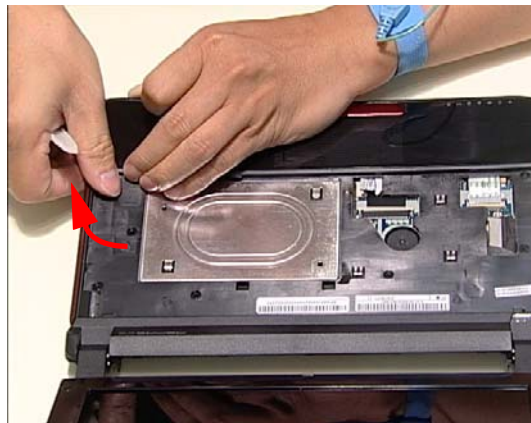

---

6. Lift the left side of the Upper Cover away from the Lower Cover.



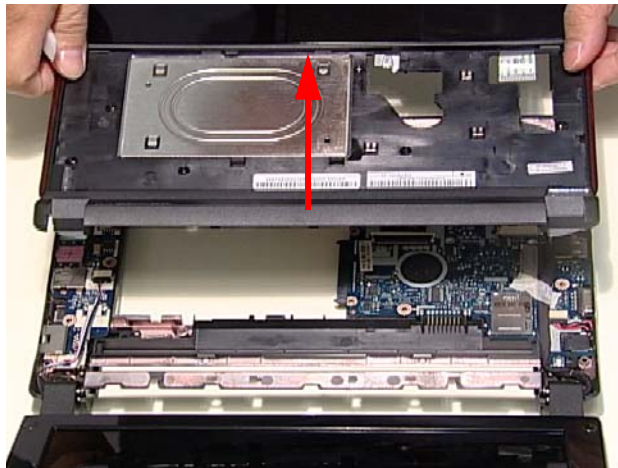

7. Lift the Upper Cover clear of the device.

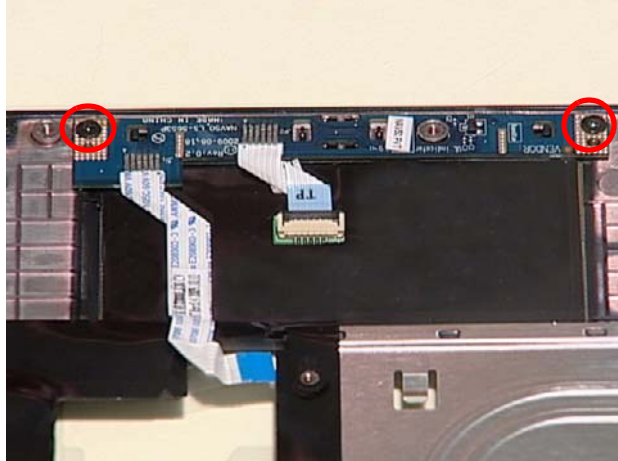

## Removing the Touchpad Board

1. See "Removing the Upper Cover" on page 54.
2. Remove two (2) screws from the Touchpad board.



| Step           | Size | Quantity | Screw Type  |
|----------------|------|----------|---|
| Touchpad Board | M2*3 | 2        |  |

3. Unlock the Touchpad cable connector and disconnect the cable.

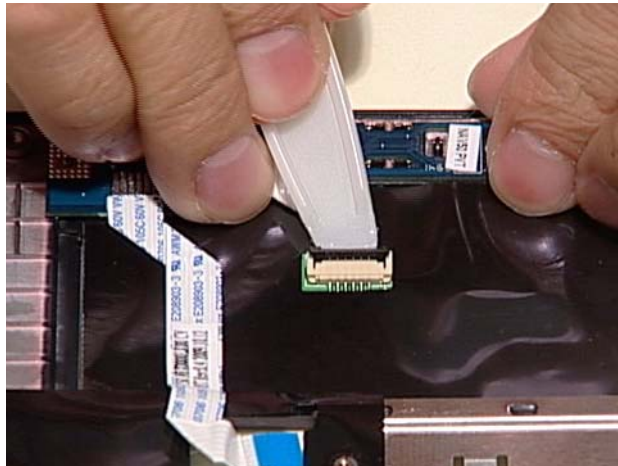

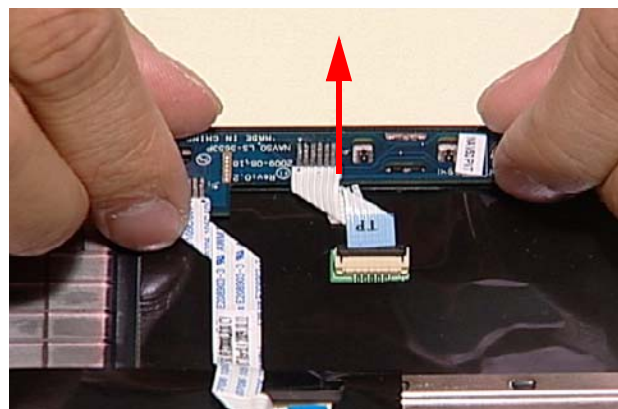

4. Lift the Touchpad Board clear of the device.

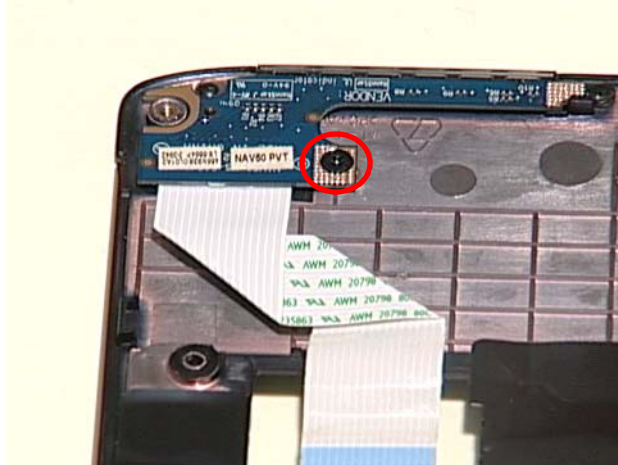

## Removing the LED Board

1. See "Removing the Upper Cover" on page 54.
2. Remove one (1) screw from the LED Board.



| Step      | Size | Quantity | Screw Type  |
|-----------|------|----------|---|
| LED Board | M2*3 | 1        |  |

3. Lift the LED Board clear of the device.

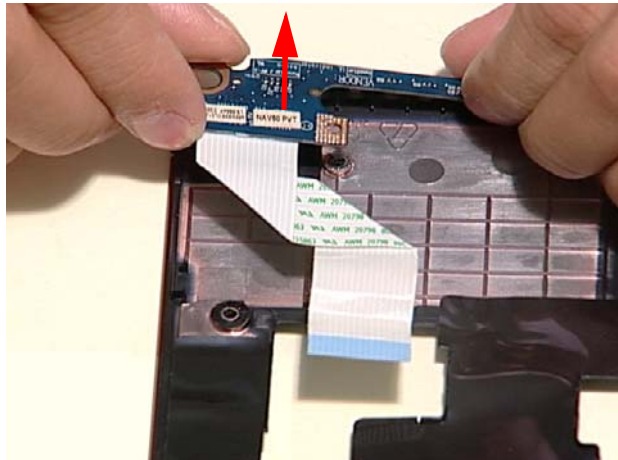

## Removing the Bridge Board

1. See "Removing the Upper Cover" on page 54.
2. Remove two (2) screws from the Bridge Board.

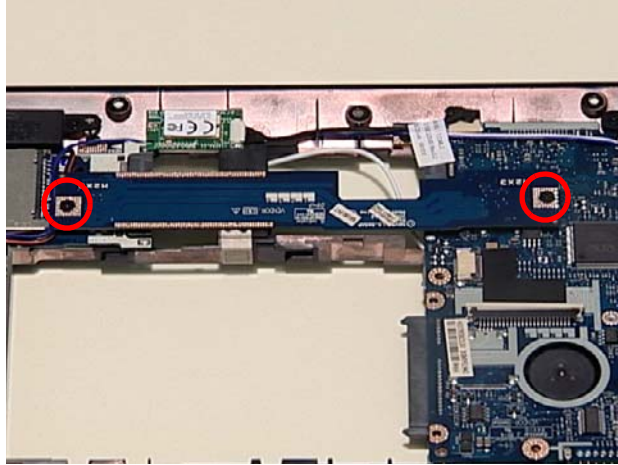

| Step         | Size | Quantity | Screw Type  |
|--------------|------|----------|---|
| Bridge Board | M2*3 | 2        |  |

3. Disconnect the Bridge Board from the connectors underneath by carefully lifting the board clear of the device.

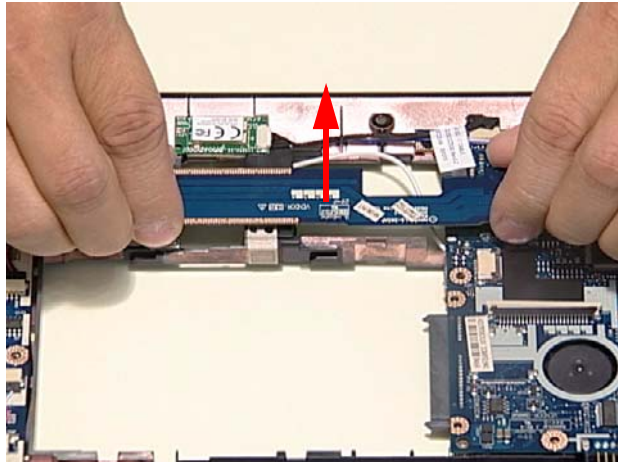

---

## Removing the Bluetooth Module

1. See "Removing the Upper Cover" on page 54.
2. Disconnect the Bluetooth to Mainboard cable.

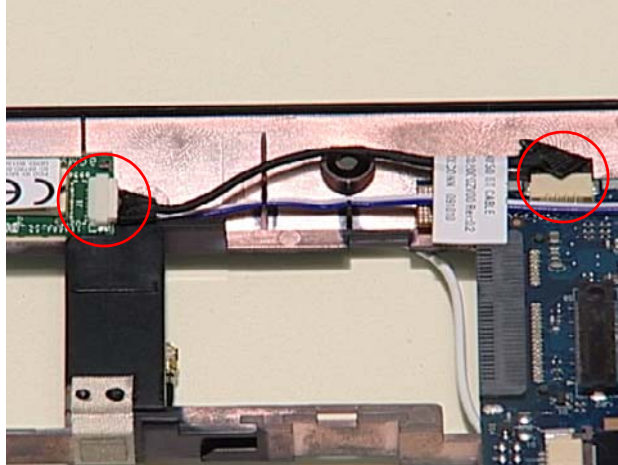

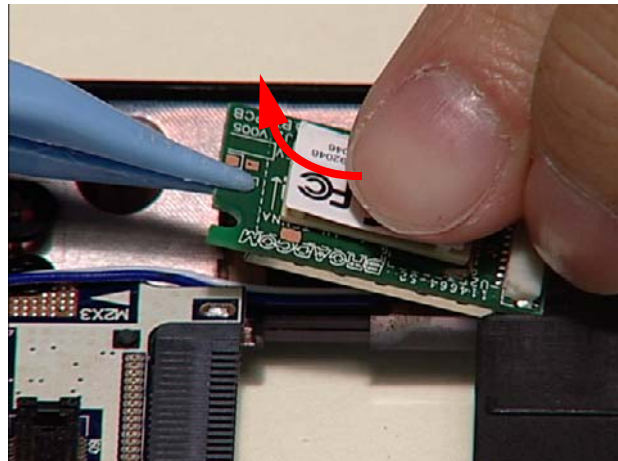

3. Lift the Bluetooth Module, left side first, to remove it from the Upper Cover.

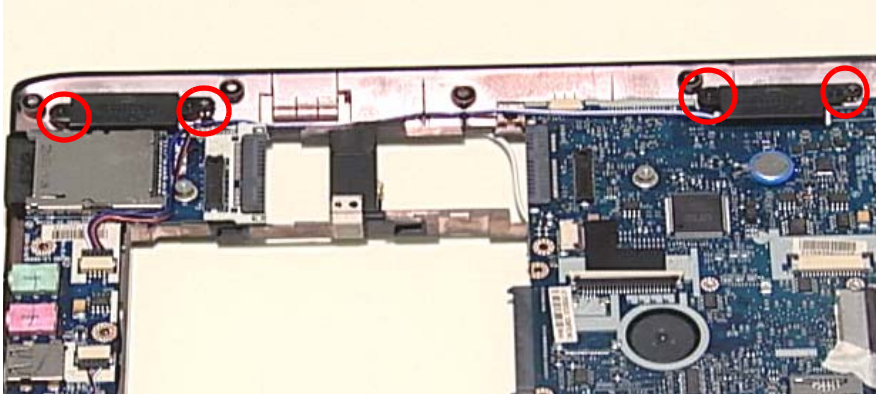

## Removing the Speaker Module

1. See "Removing the Upper Cover" on page 54.
2. Remove the four (4) securing screws (two for each Speaker).



| Step           | Size | Quantity | Screw Type  |
|----------------|------|----------|---|
| Speaker Module | M2*4 | 4        |  |

3. Disconnect the Speaker cable as shown.

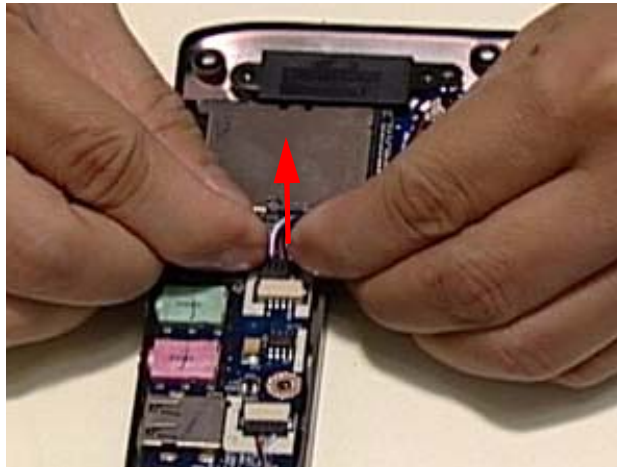

- 
4. Lift out the left speaker while removing the Speaker cable from the cable channel. Ensure that the cable is free from all cable clips.

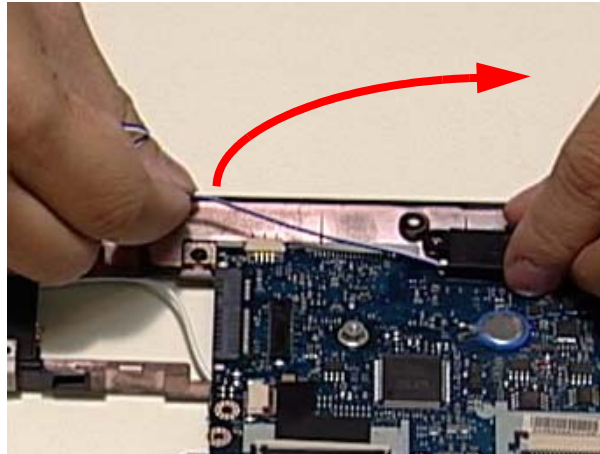

5. Lift the Speaker Module clear of the Lower Cover.

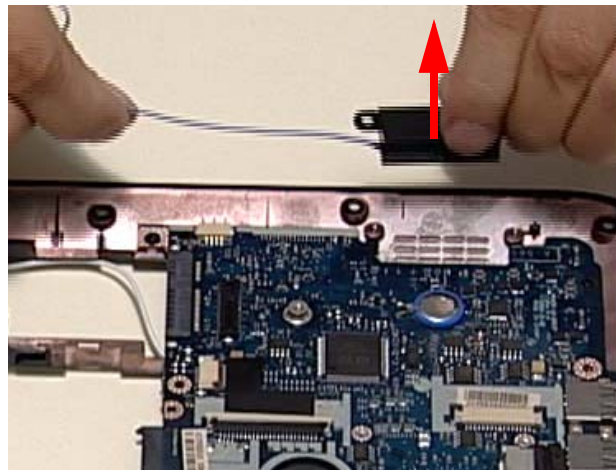



## Removing the I/O Board

1. See "Removing the Upper Cover" on page 54.
2. Remove one (1) screw from the I/O Board.

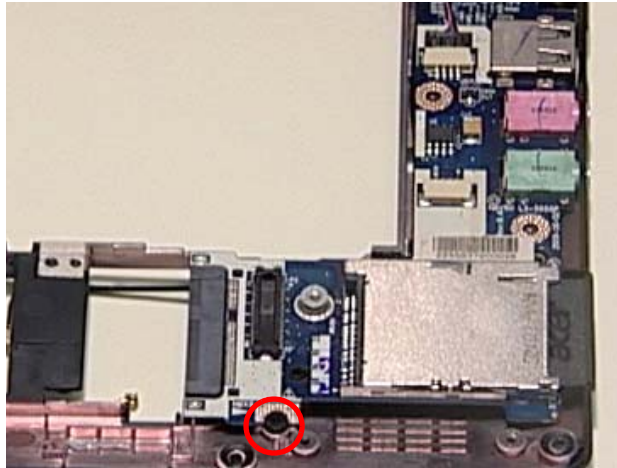

| Step      | Size | Quantity | Screw Type  |
|-----------|------|----------|---|
| I/O Board | M2*3 | 1        |  |

3. Disconnect the I/O Board cable.

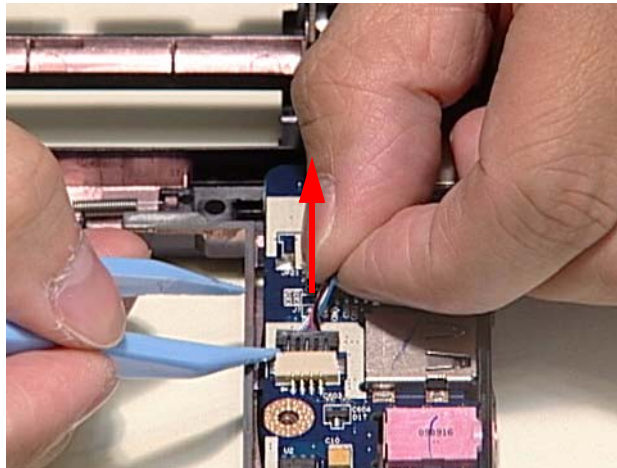

---

4. Remove the I/O Board by angling the board upwards and pulling it out of the connector bracket as shown.

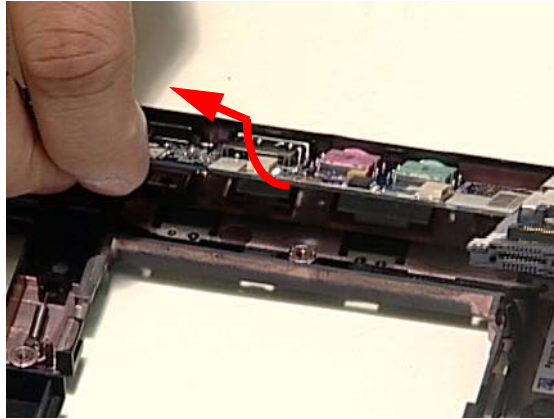

## Removing the Mainboard

1. See "Removing the Speaker Module" on page 61.
2. Remove the LVDS adhesive tape.

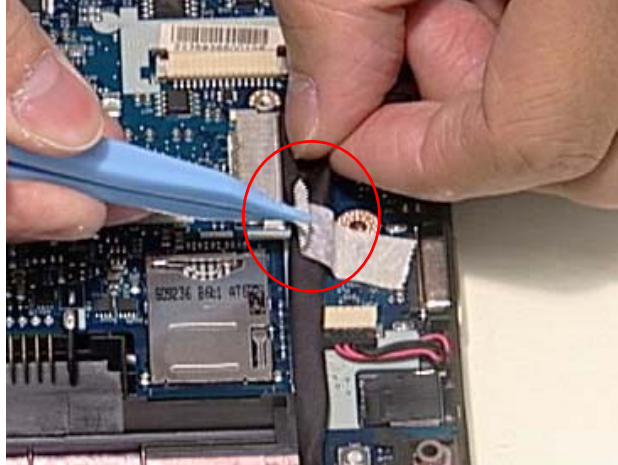

3. Disconnect the LVDS cable and remove the cable from the cable channel.

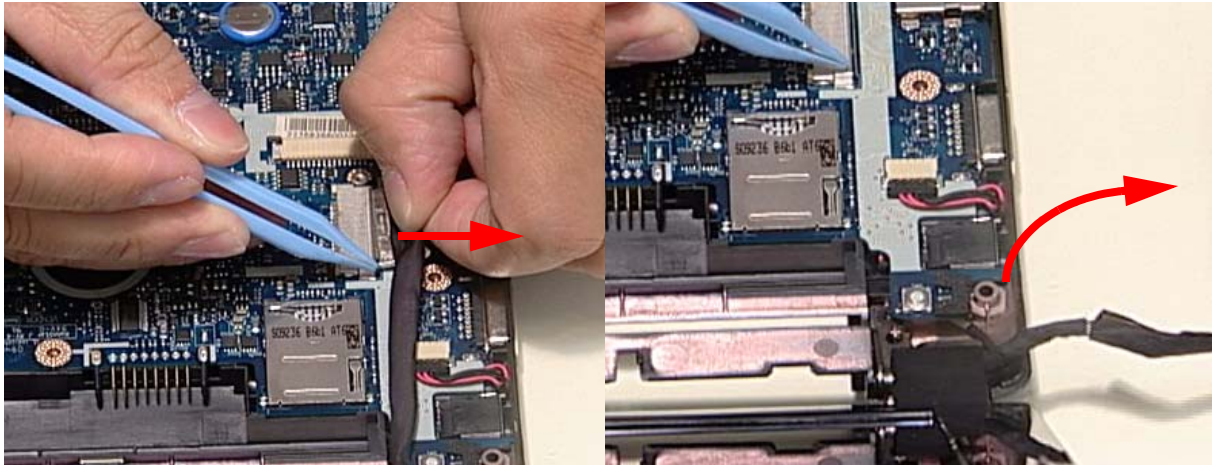

4. Disconnect the AC cable as shown.

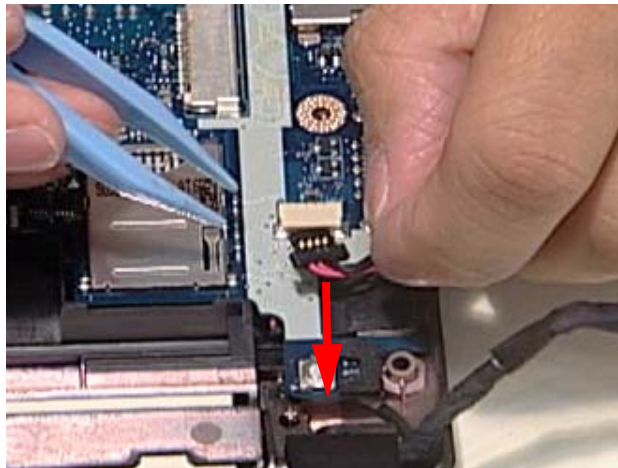

5. Remove the one (1) screw securing the Mainboard to the Lower Cover.

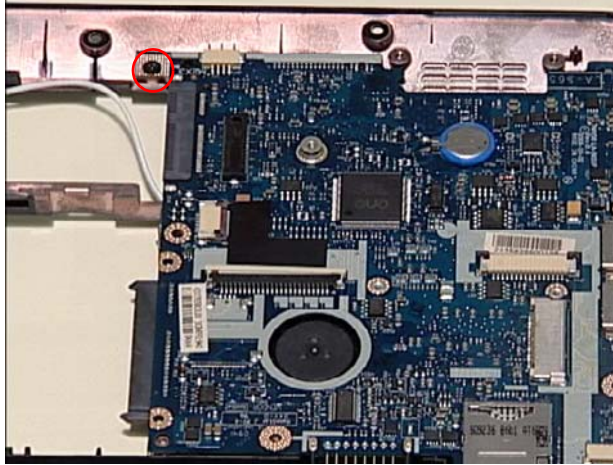

| Step      | Size | Quantity | Screw Type  |
|-----------|------|----------|---|
| Mainboard | M2*4 | 1        |  |

6. Lift the Mainboard from the side opposite the connector bracket, then remove it from the Lower Cover.

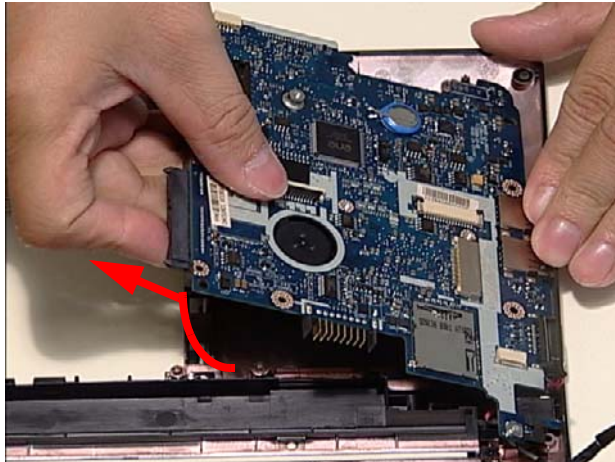

7. Remove the DC-in port from the Lower Cover.

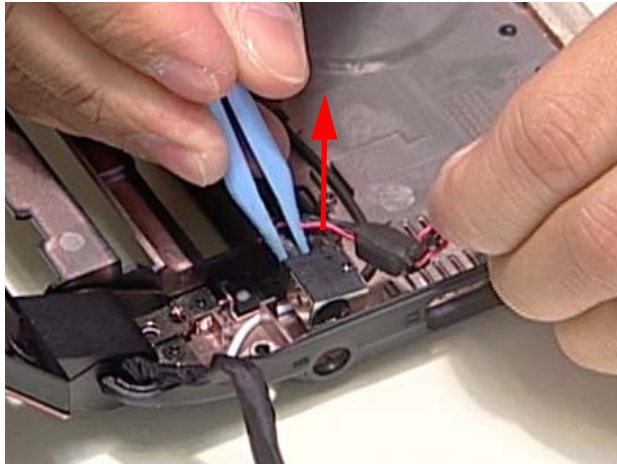



## Removing the Thermal Module

1. See "Removing the Mainboard" on page 65.
2. Disconnect the Fan cable from the Mainboard.

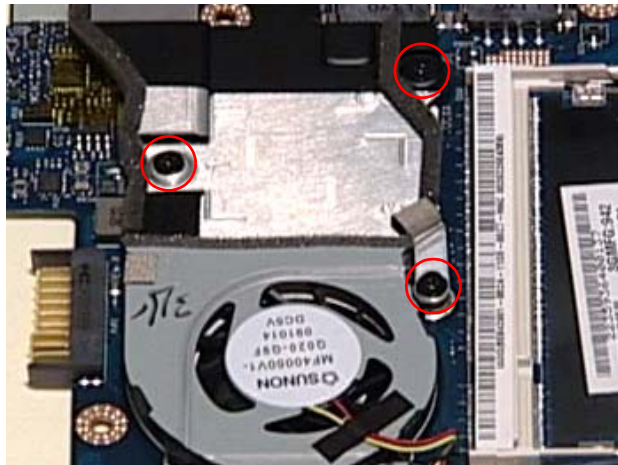

3. Remove the three (3) securing screws from the Thermal Module.



| Step           | Size | Quantity | Screw Type  |
|----------------|------|----------|---|
| Thermal Module | M2*4 | 3        |  |

---

4. Lift the Thermal Module clear of the Mainboard.

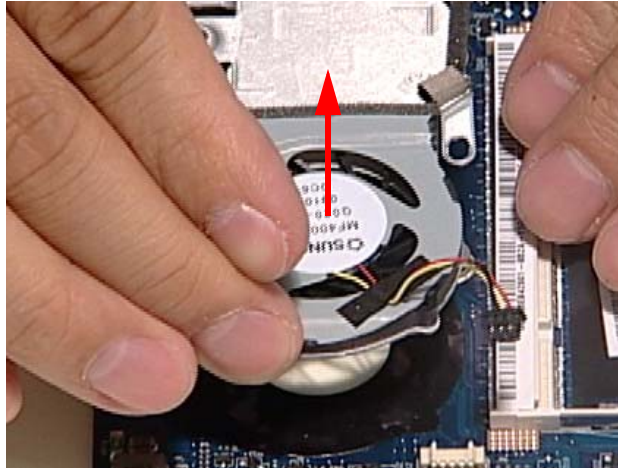

---

## Removing the LCD Module

**IMPORTANT:** Cable paths and positioning may not represent the actual model. During the removal and replacement of the LCD Module, ensure all available cable channels and clips are used and that the cables are replaced in the same position.

1. See “Removing the Mainboard” on page 65.
2. Turn the device over and pull the white antenna cable out of the cable channel. Make sure the cable is free of the cable clips indicated.

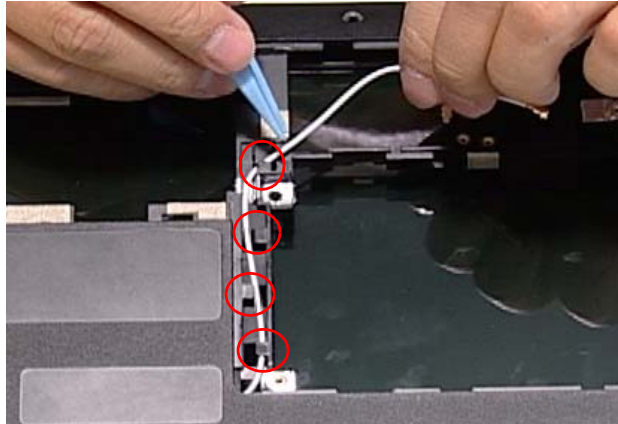

3. Use both hands to pull the white antenna cable through the Lower Cover. Continue removing the cable from the cable channel as shown.

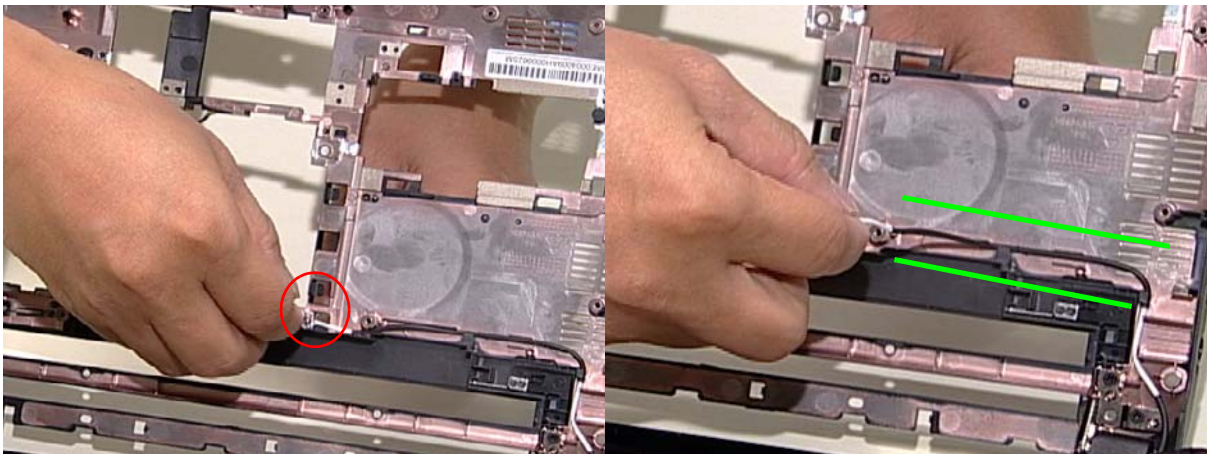

4. Pull the black antenna cable through the Lower Cover and release it from the cable channel as shown.

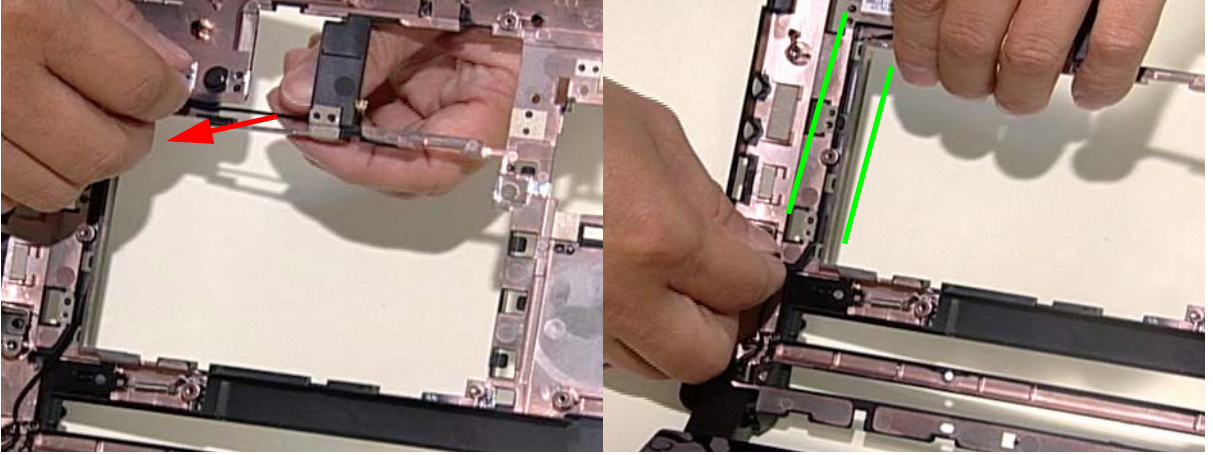

5. Remove two (2) screws from the LCD Assembly.



| Step         | Size | Quantity | Screw Type  |
|--------------|------|----------|---|
| LCD Assembly | M2*4 | 2        |  |

6. Lift the LCD Assembly clear of the device.

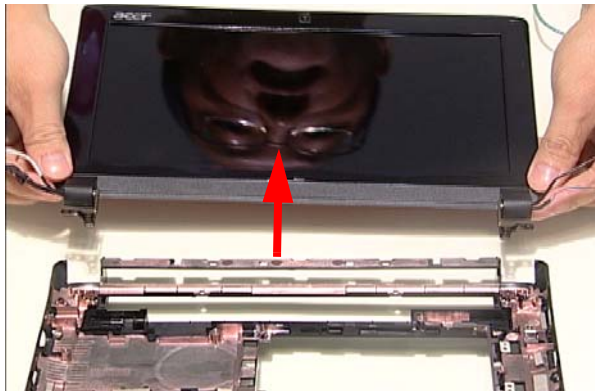



# LCD Module Disassembly Process

**IMPORTANT:** Cable paths and positioning may not represent the actual model. During the removal and replacement of components, ensure all available cable channels and clips are used and that the cables are replaced in the same position.

**NOTE:** The product previews seen in the disassembly procedures may not represent the final product color or configuration. The following procedure outlines the steps to disassemble the LCD Module on models with 3G functionality. Models that do not support 3G do not require the removal of the yellow and blue Antenna cables detailed below.

## LCD Module Disassembly Flowchart

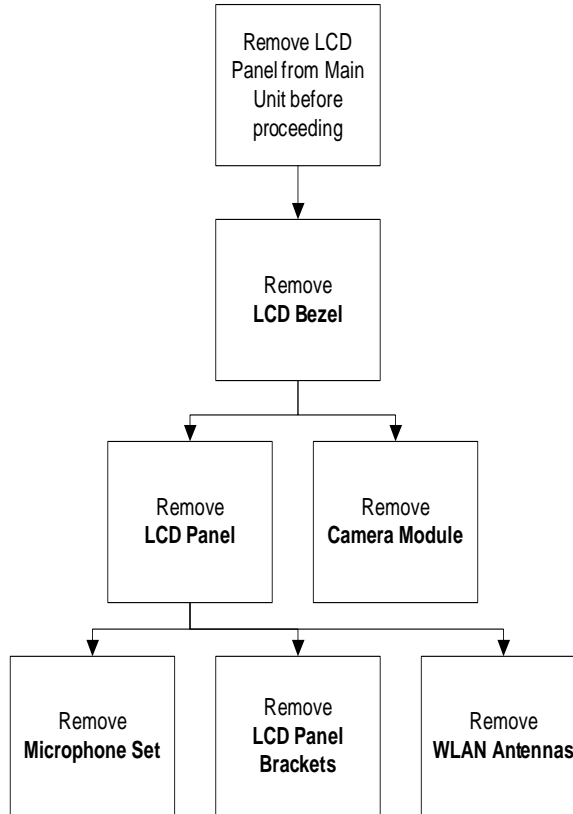

### Screw List

| Step         | Screw | Quantity | Part No.     |
|--------------|-------|----------|--------------|
| LCD Bezel    | M2*4  | 2        | 86.SAS02.002 |
| LCD Panel    | M2*4  | 4        | 86.SAS02.002 |
| LCD Brackets | M2*3  | 4        | 86.SAS02.001 |

## Removing the LCD Bezel

1. See "Removing the LCD Module" on page 69.
2. Remove the two (2) screw caps and two (2) screws from the LCD Bezel.



| Step      | Size | Quantity | Screw Type  |
|-----------|------|----------|---|
| LCD Bezel | M2*4 | 2        |  |

3. Carefully pry the LCD Bezel from the LCD Assembly using both hands. If necessary, use a plastic pry to release the corners of the bezel. When all the guide hooks have been released, lift the bezel clear of the assembly.

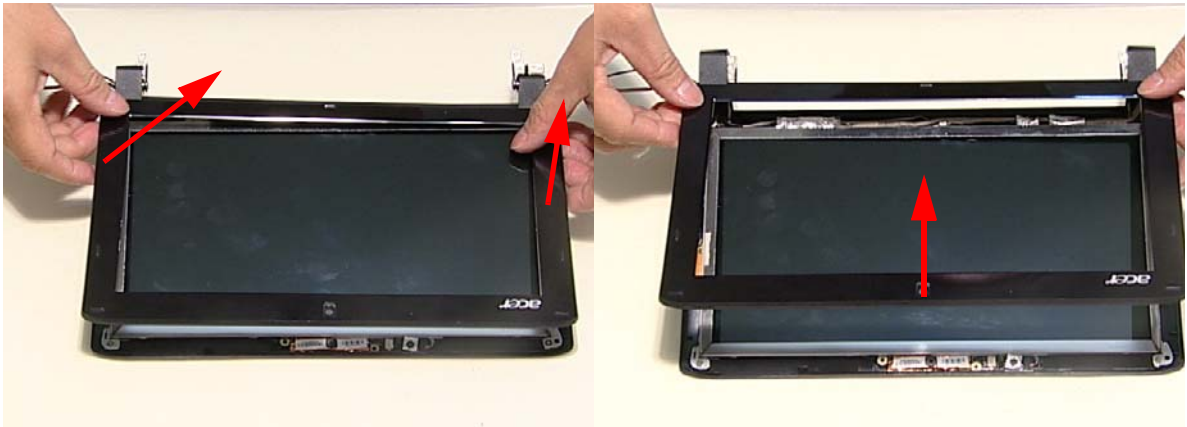

---

## Removing the Camera Board

1. See "Removing the LCD Bezel" on page 72.

**CAUTION:** Do not use excessive force when handling the Web Camera Board.

2. Disconnect the cable from the Web Camera Board as shown.

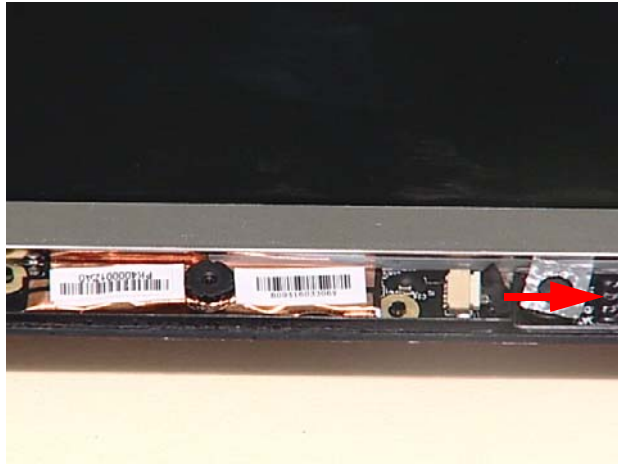

3. Detach the Web Camera Board while being careful not to handle the board with excessive force.

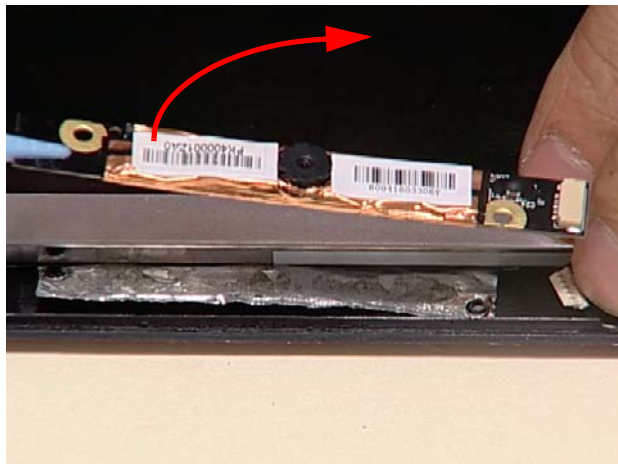

# Removing the LCD Panel

- 1. See "Removing the Camera Board" on page 73.
- 2. Remove the four (4) securing screws from the LCD Panel.



| Step      | Size | Quantity | Screw Type  |
|-----------|------|----------|---|
| LCD Panel | M2*4 | 4        |  |

- 3. Remove the LVDS foil tab and pull the LVDS cable away from the channel as shown.



- 4. Lift the LCD Panel clear of the LCD Bracket.

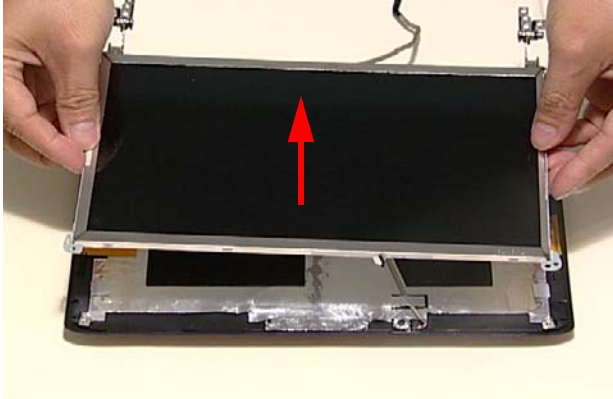

---

## Removing the Microphone Set

1. See "Removing the LCD Panel" on page 74.
2. Remove the foil tabs from the Microphone set while lifting the cable away from the cable channel.

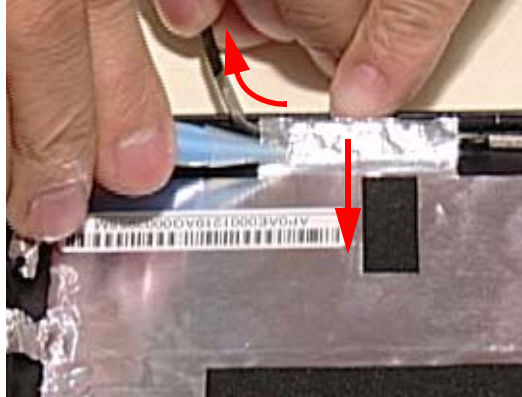

3. Continue removing the foil tabs and pulling the cable away. The cable channel is highlighted between the green lines.

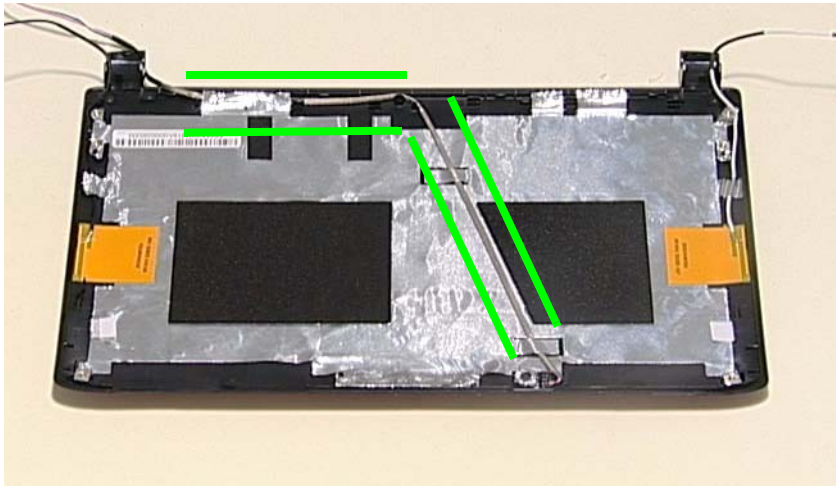

4. Peel back the foil tab and lift the Microphone set clear of the device.



---

## Removing the WLAN Antennas

1. See “Removing the LCD Panel” on page 74.
2. Peel back the foil tabs on the black antenna cable.



3. Pull the cable away from the cable channel, which is highlighted between the green lines.



4. Pry the antenna pad clear of the bracket.

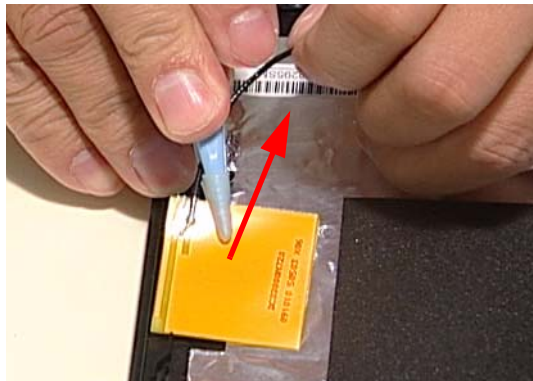

5. Peel back the foil tabs on the white antenna cable.

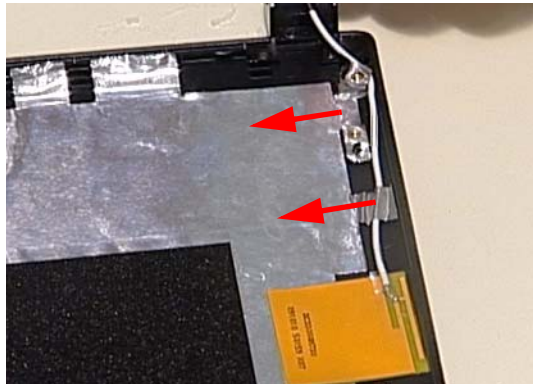

6. Pull the cable away from the cable channel, which is highlighted between the green lines.

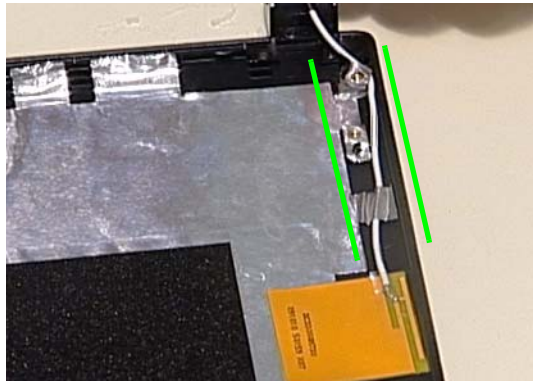

7. Pry the antenna pad clear of the bracket.



# Removing the LCD Brackets

1. See "Removing the Microphone Set" on page 75.
2. Turn the LCD Panel over and peel away the LVDS cable.



3. Detach the clear connector tape and disconnect the LVDS cable.



4. Remove four (4) screws that secure the LCD Panel.

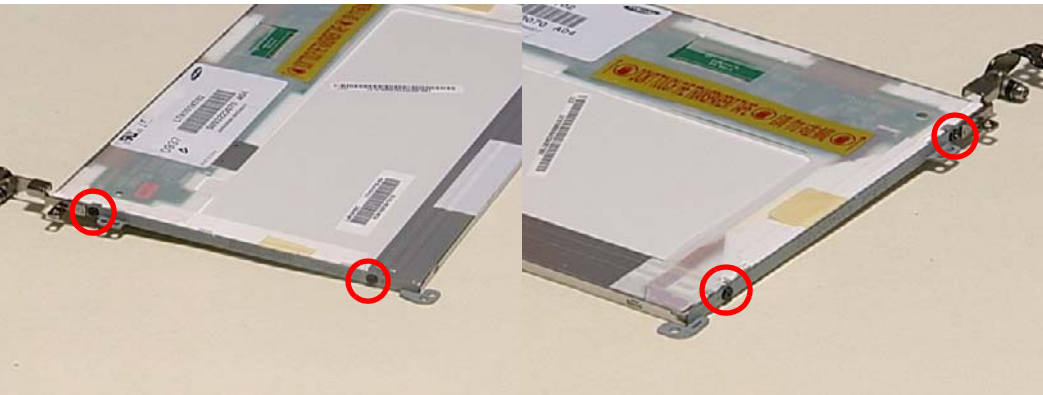

| Step         | Size | Quantity | Screw Type  |
|--------------|------|----------|---|
| LCD Brackets | M2*4 | 4        |  |



---

5. Remove two (2) brackets from the LCD Panel.

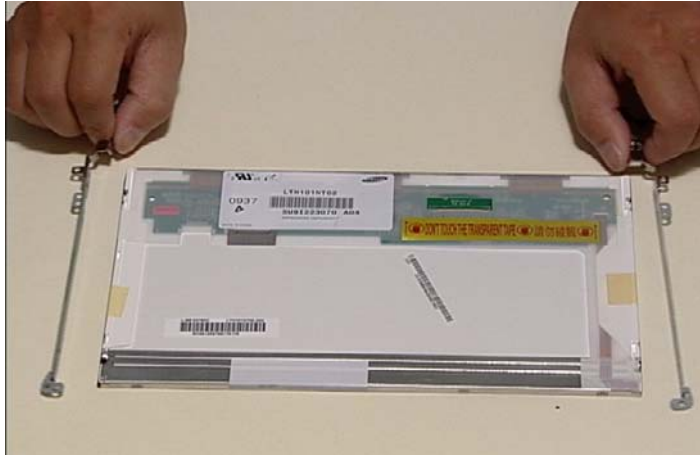

---

# LCD Module Reassembly Procedure

## Replacing the LCD Brackets

1. Replace two (2) brackets to the LCD Panel.

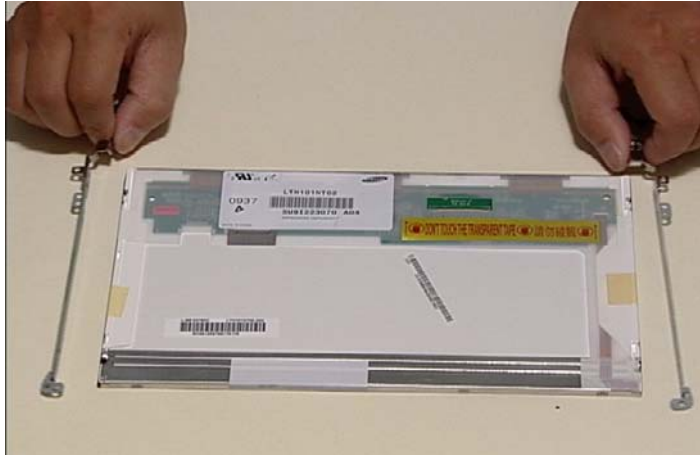

2. Secure the LCD Panel using four (4) screws.

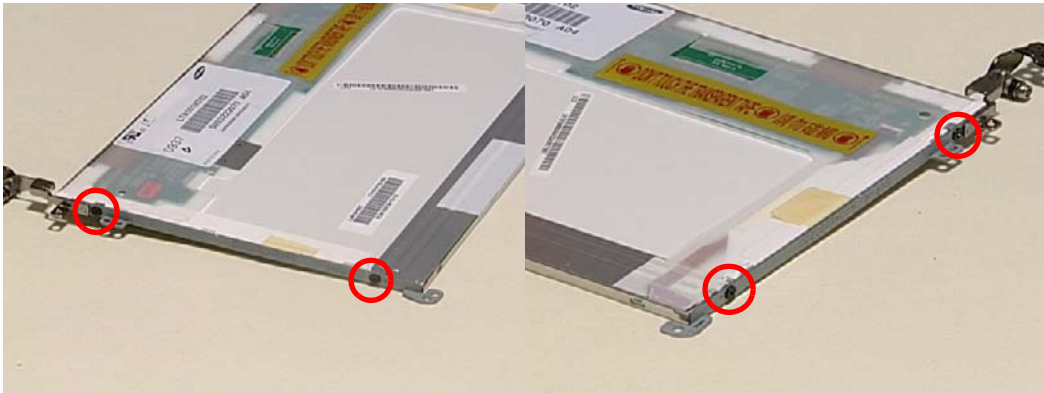

3. Connect the LVDS cable to the LCD Panel and reattach the clear connector tape.

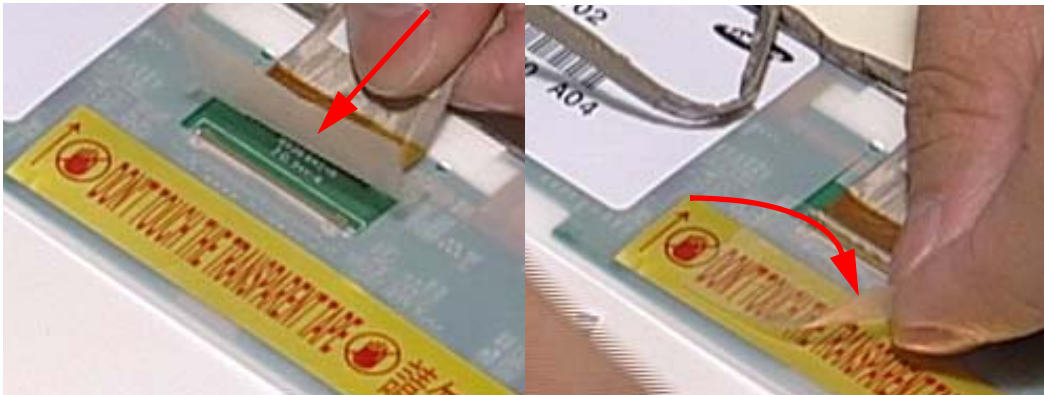

---

**CAUTION:** Align the cable with the camera module. If the cable is misaligned, the camera module may shift causing the camera to sit in the wrong location.

4. Lay the cable across the LCD Panel in the area indicated between the green lines. Press down to adhere the cable.

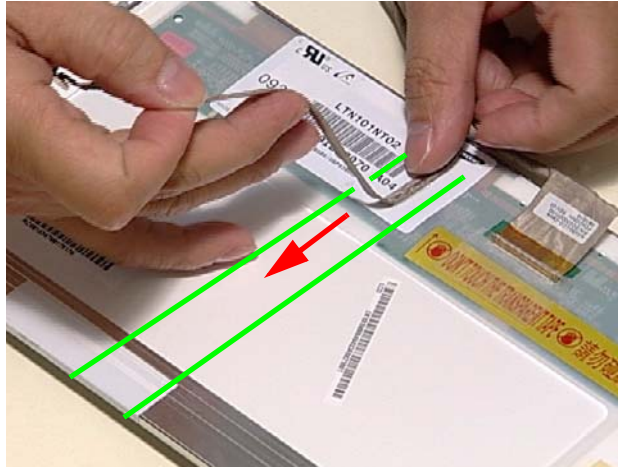

# Replacing the WLAN Antennas

1. Place the antenna pad in the bracket.

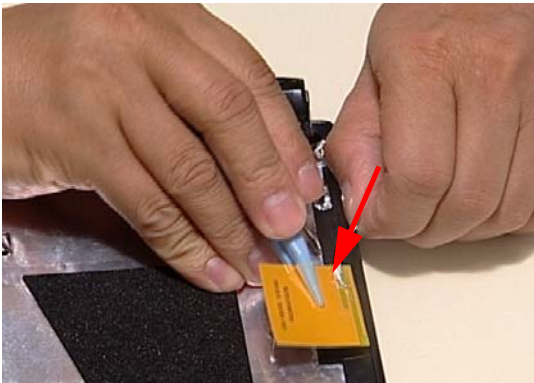

2. Run the cable along the cable channel, which is highlighted between the green lines.

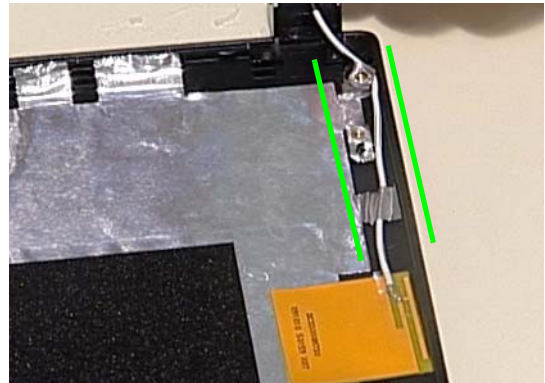

3. Adhere the foil tabs to the white antenna cable.

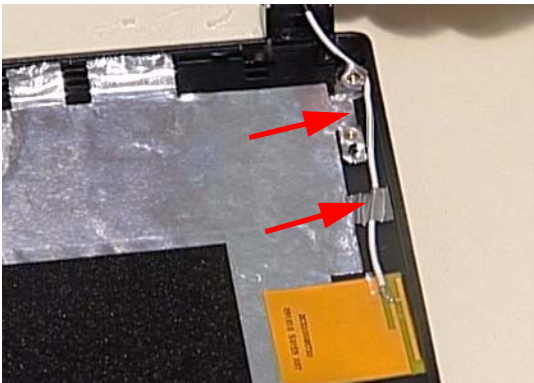

4. Place the antenna pad in the bracket.



5. Run the cable along the cable channel, which is highlighted between the green lines.



6. Adhere the foil tabs to the black antenna cable.



---

## Replacing the Microphone Set

1. Replace the Microphone set and fold over the foil tab.

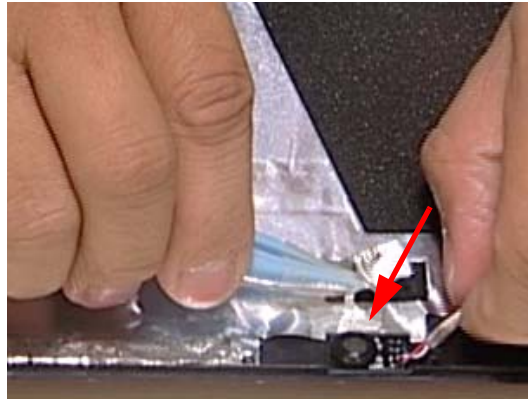

2. Run the cable along the cable channel while adhering the foil tabs. The cable channel is highlighted between the green lines.

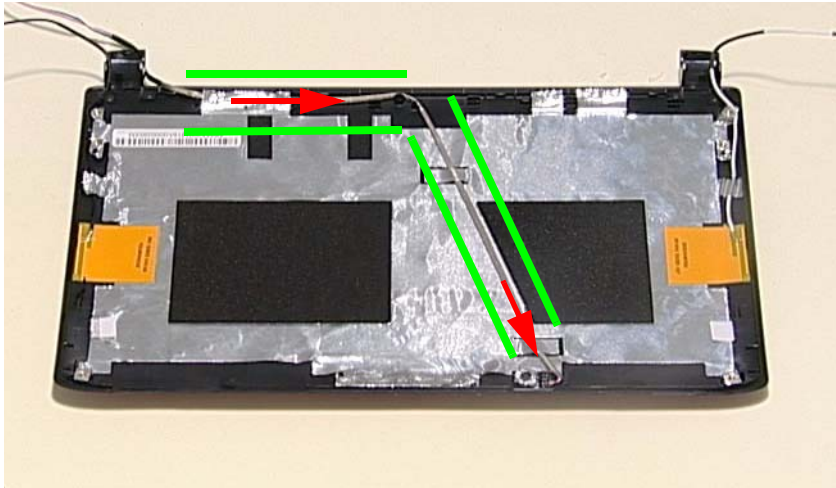

3. Secure the last foil tab near the bottom left of the bracket.

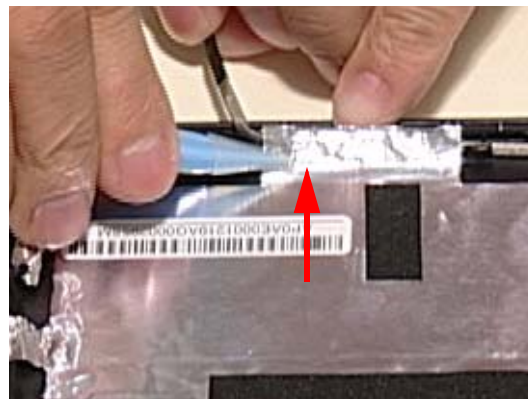

---

# Replacing the LCD Panel

1. Place the LCD Panel in the LCD Bracket.

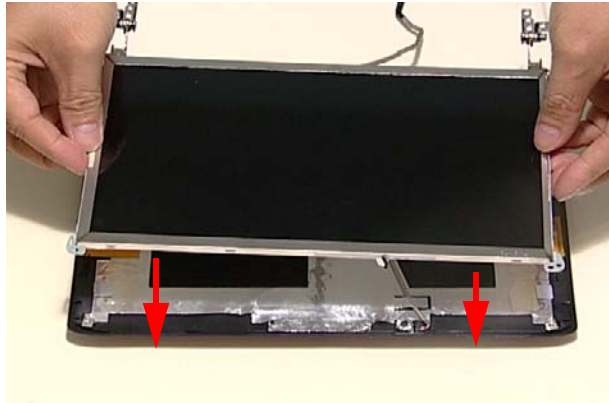

2. Secure the LCD Assembly using four (4) screws.

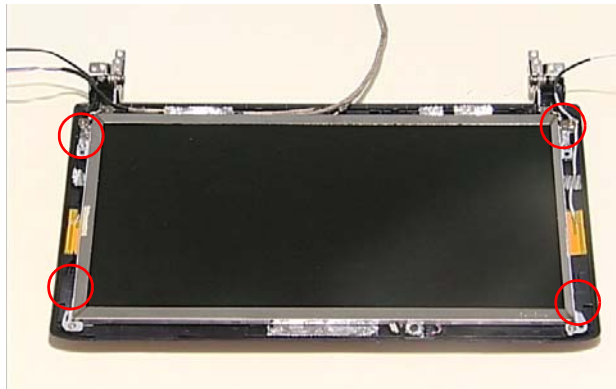

3. Run the LVDS cable in the cable channel while replacing the foil tabs.

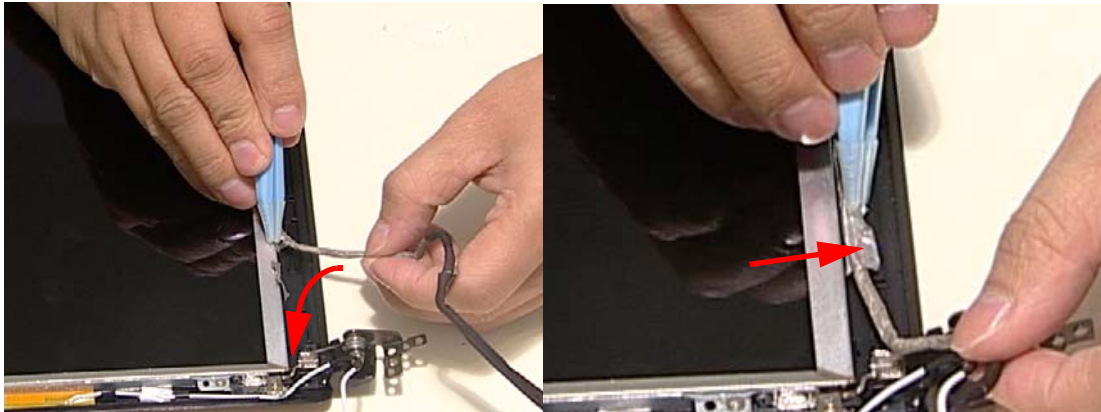

---

## Replacing the Camera Board

**CAUTION:** Do not handle the Web Camera Board with excessive force.

1. Attach the Web Camera Board to the inside of the bracket. Press down to secure the board in place.

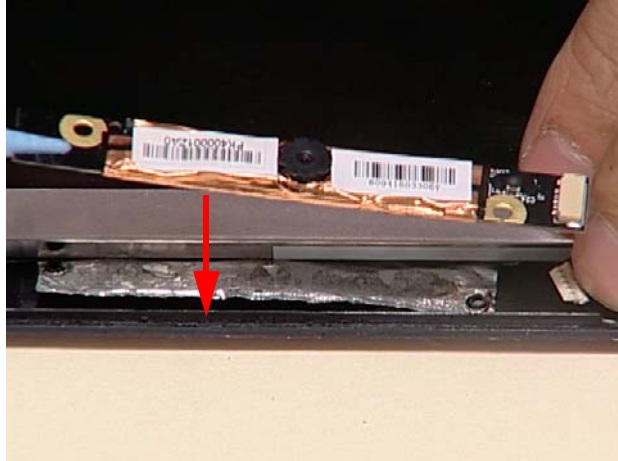

2. Connect the Camera cable as shown.

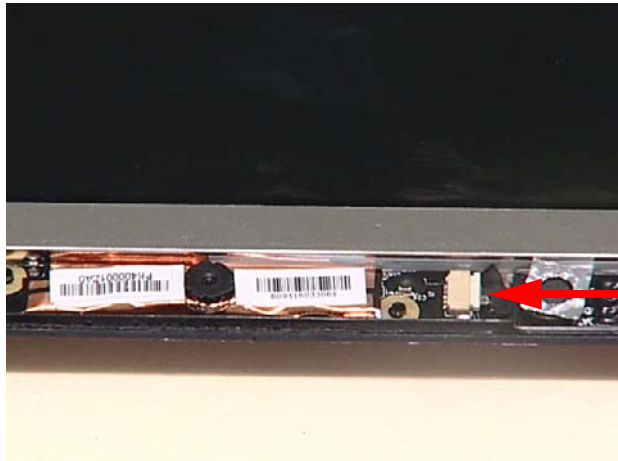

---

## Replacing the LCD Bezel

1. Place the LCD Bezel on the LCD Assembly. Press down on all sides to make sure the bezel is fitted securely.



2. Secure the LCD Bezel using two (2) screws and two (2) screw caps.





---

# Main Module Reassembly Procedure

## Replacing the LCD Module

1. Place the LCD Module on the Lower Cover.

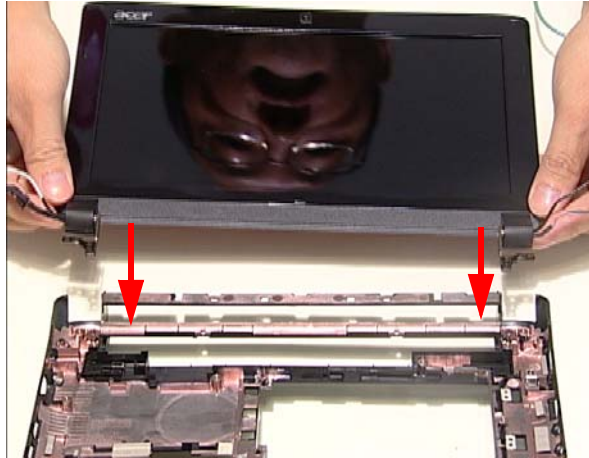

2. Secure the LCD Module using two (2) screws.



3. Run the black antenna cable through the cable channel and pull it through the casing as shown.

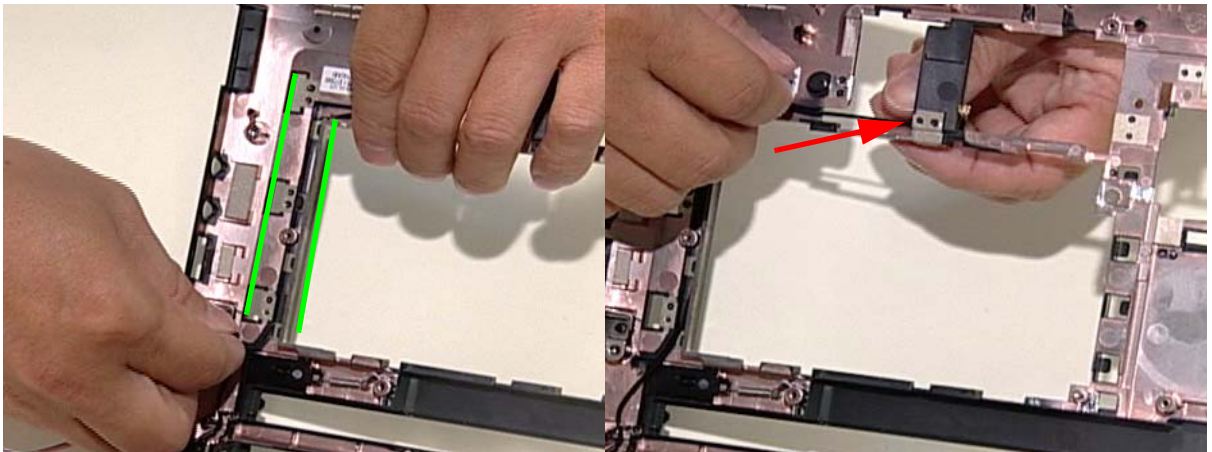

4. Run the white antenna cable through the cable channel and pull it through the casing as shown.

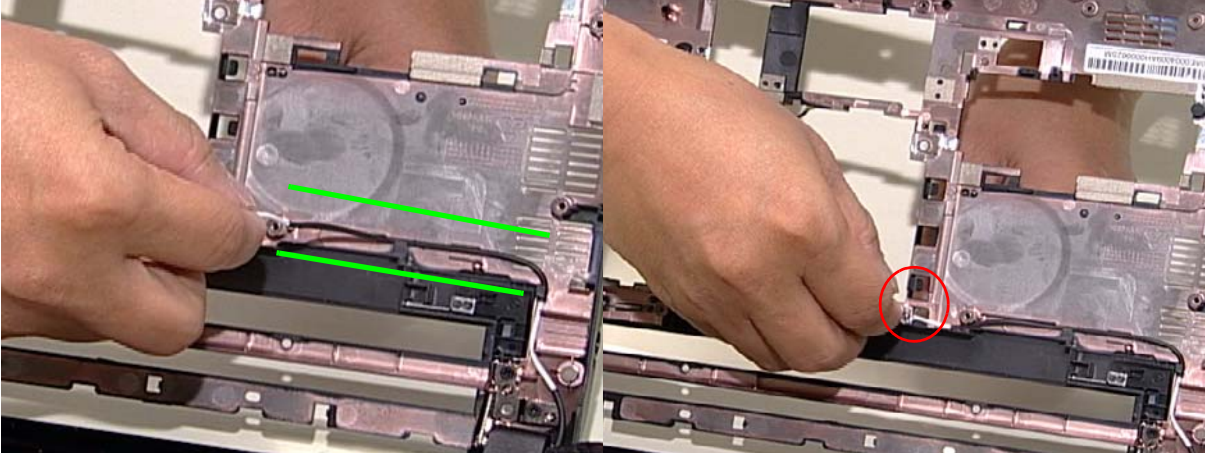

5. Turn the device over and continue running the white antenna cable through the cable channel. Make sure the cable is secured under the cable clips indicated.

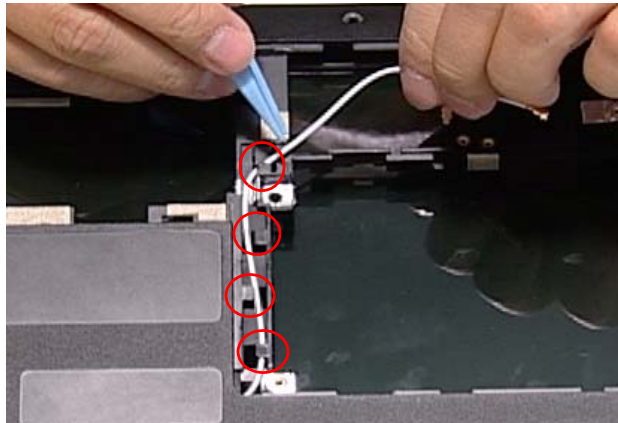

---

## Replacing the Thermal Module

**IMPORTANT:** Ensure all heat pads are in place before replacing the Thermal Module.

The following thermal pads are approved for use:

- Eapus XR-PE
1. Align the screw holes on the Thermal Module and Mainboard and replace the module.

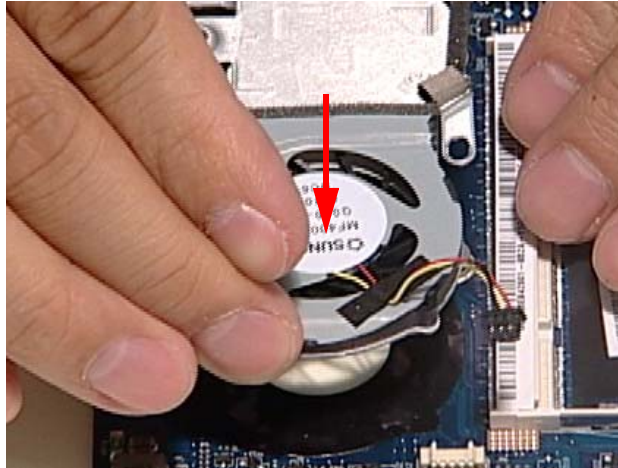

2. Secure the Thermal Module using three (3) screws.

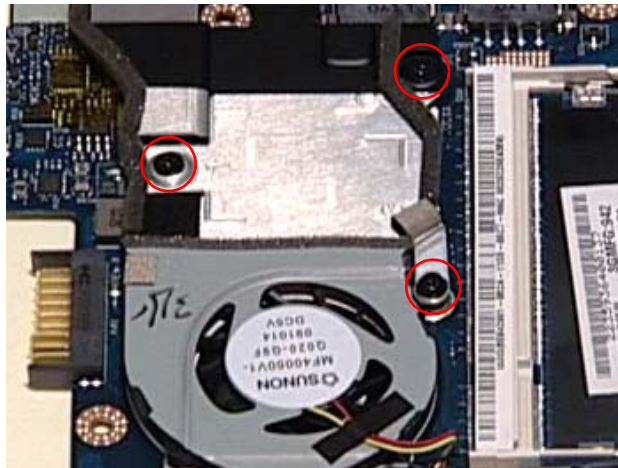

3. Connect the fan to mainboard cable.

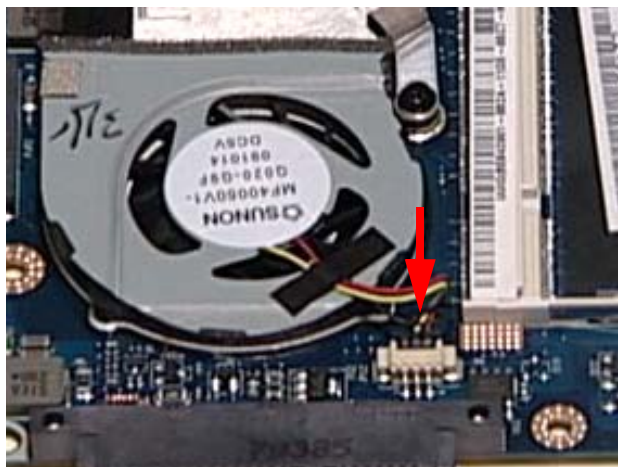

# Replacing the Mainboard

1. Place the DC-in port in the Lower Cover.

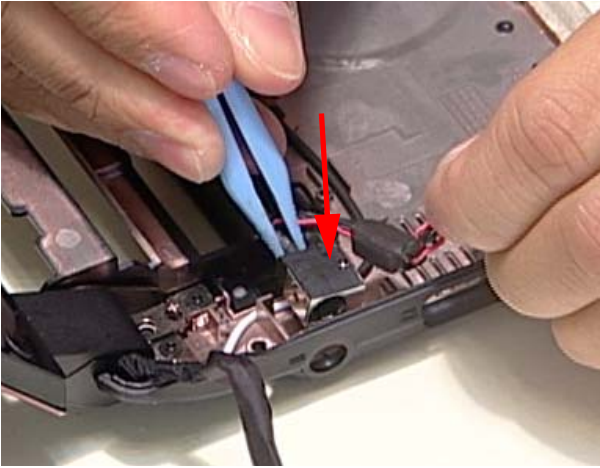

2. Replace the Mainboard by lining up the connector bracket before replacing completely.

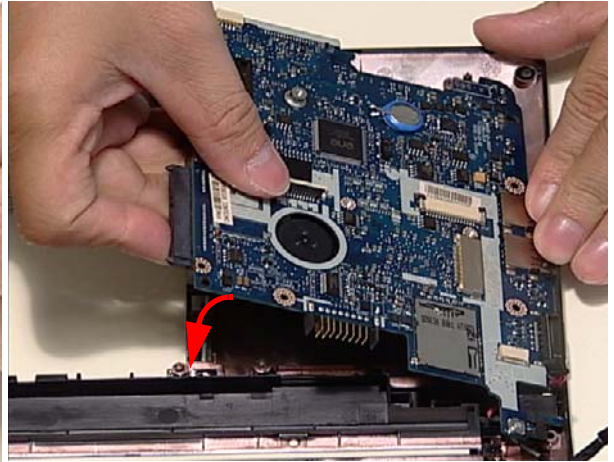

3. Secure the Mainboard using one (1) screw.

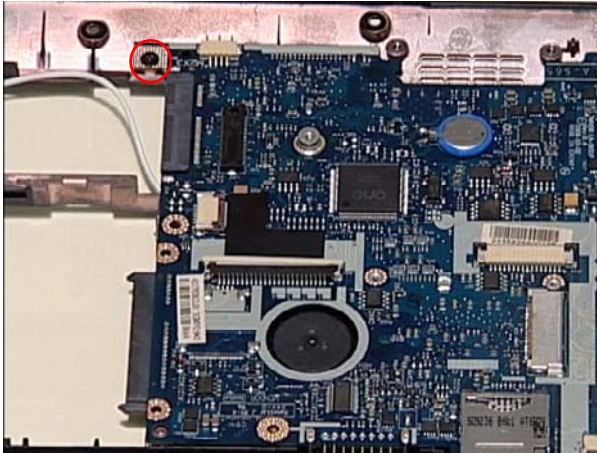

4. Connect the AC cable.

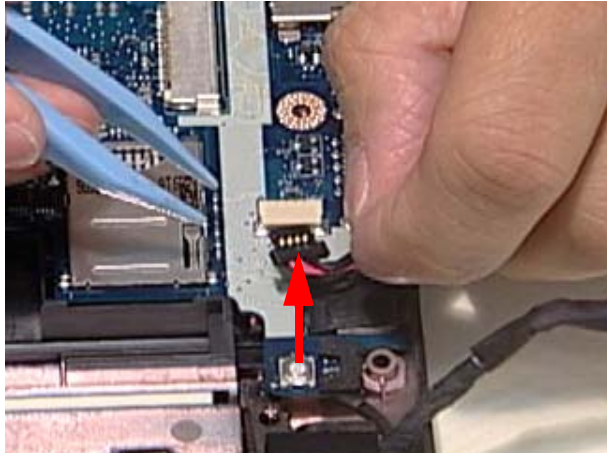

5. Run the LVDS cable along the cable channel as shown.

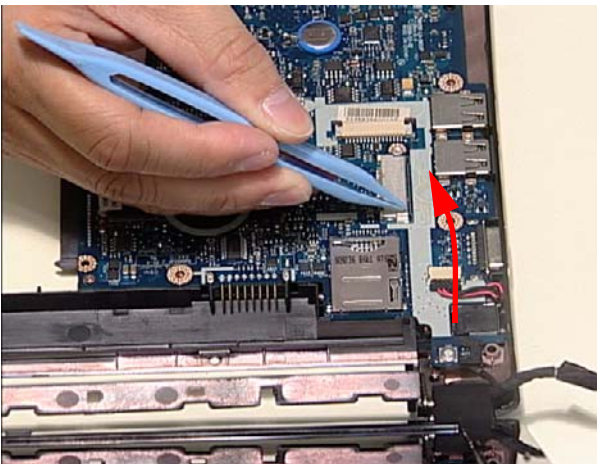

6. Connect the LVDS cable to the Mainboard.

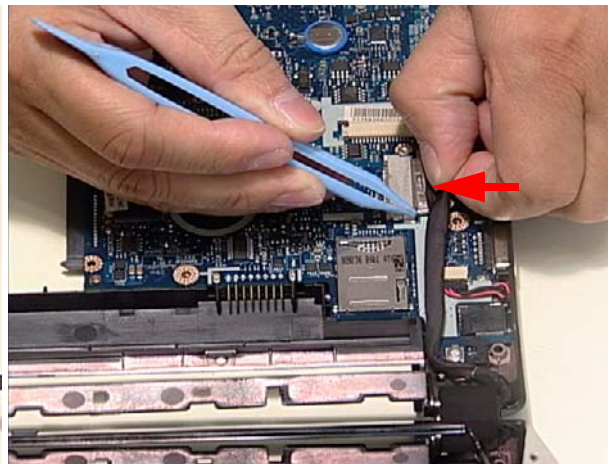

7. Replace the LVDS adhesive tape.

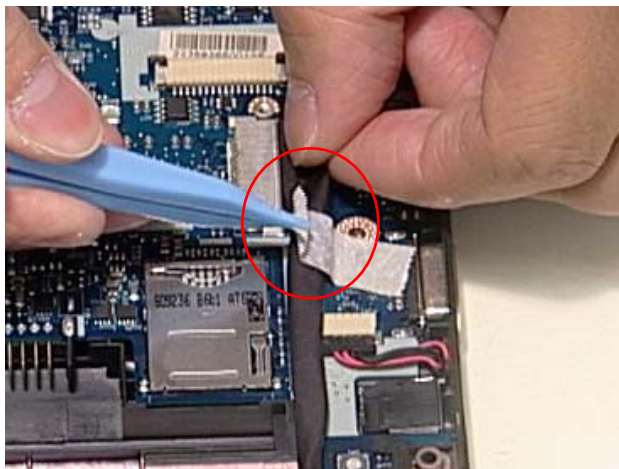

## Replacing the I/O Board

1. Replace the I/O Board by lining up the board with the connector bracket as shown.

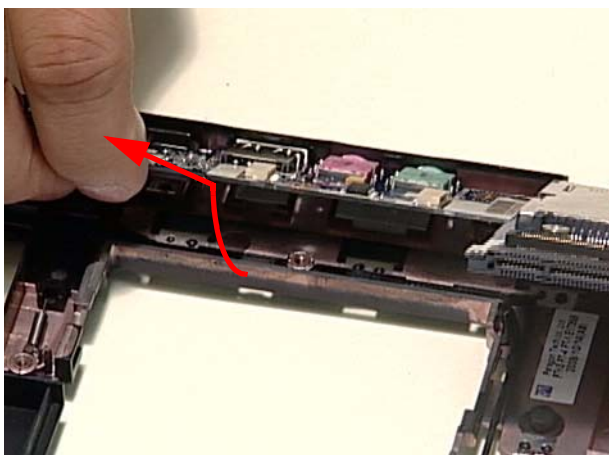

2. Connect the I/O cable.

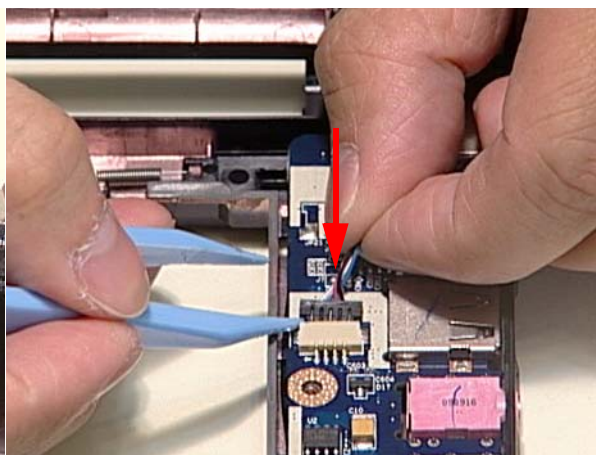

3. Secure the I/O Board by replacing one (1) screw.

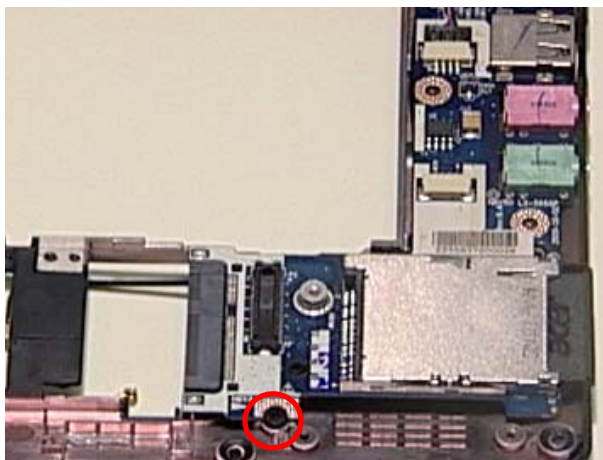

---

## Replacing the Speaker Module

1. Secure the Speaker Module by replacing four (4) screws.

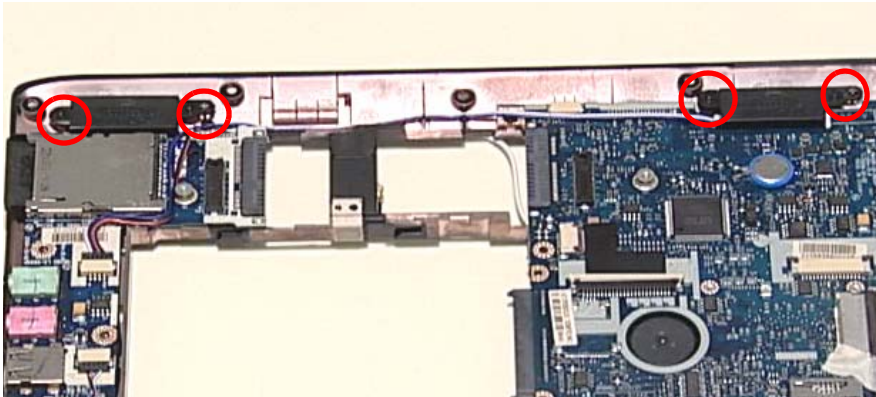

2. Connect the Speaker cable as shown.

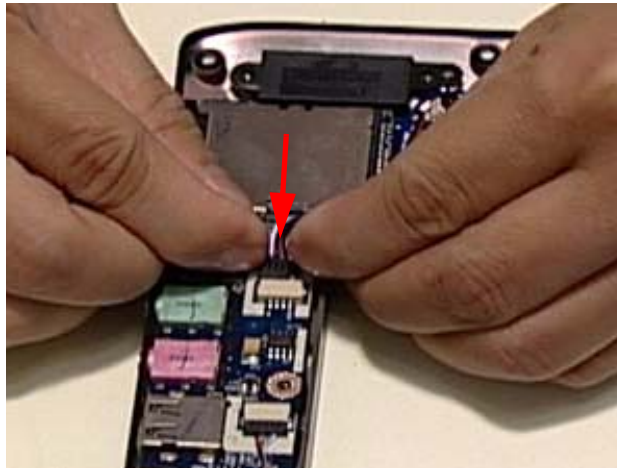

## Replacing the Bluetooth Module

1. Attach the Bluetooth Board to the casing. Press down to secure it in place.
2. Connect the Bluetooth to Mainboard cable.

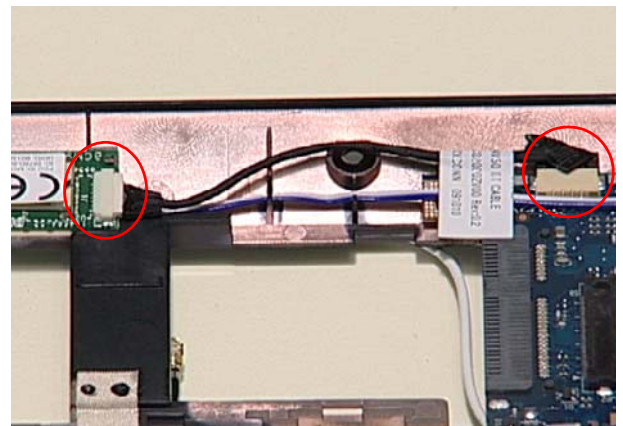
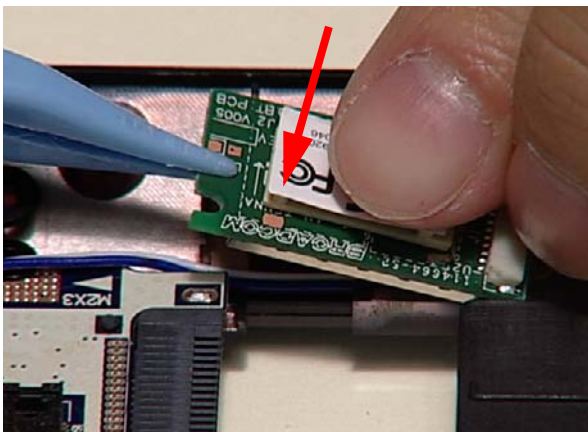

---

## Replacing the Bridge Board

1. Notice the connectors located on the underside of the Bridge Board. Reconnect the Bridge Board by lining the board up with the connectors as shown.

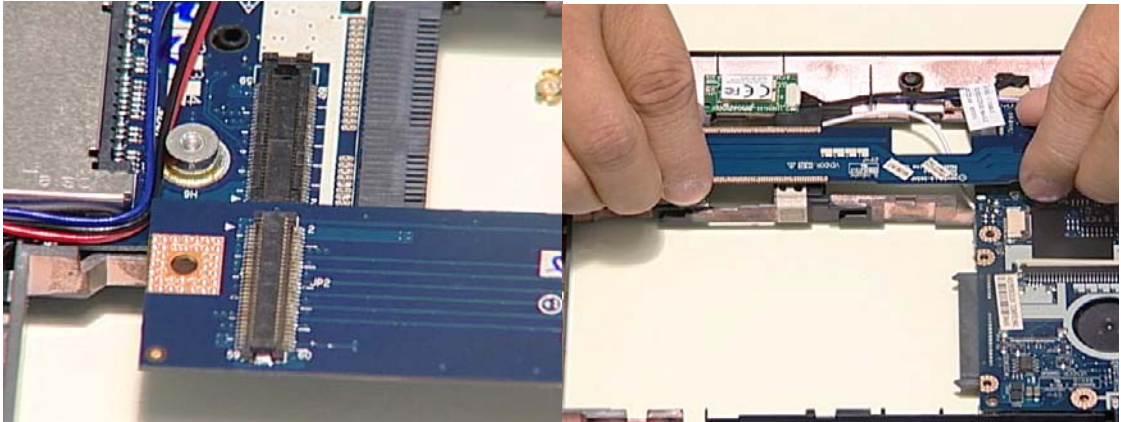

**NOTE:** Press down firmly to ensure the two connectors are properly seated.

2. Secure the Bridge Board using two (2) screws.

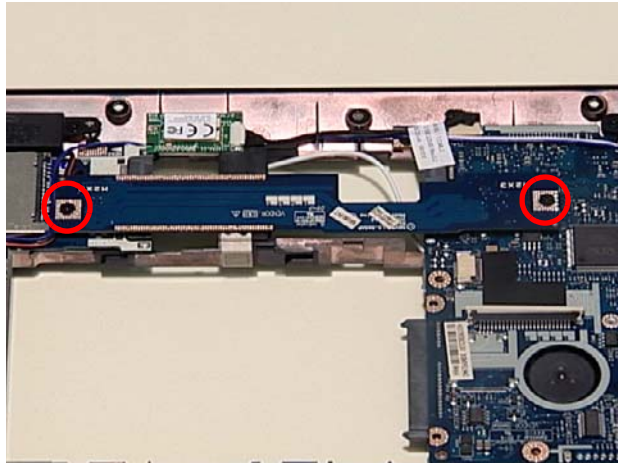

---

## Replacing the LED Board

1. Place the LED Board in the device.

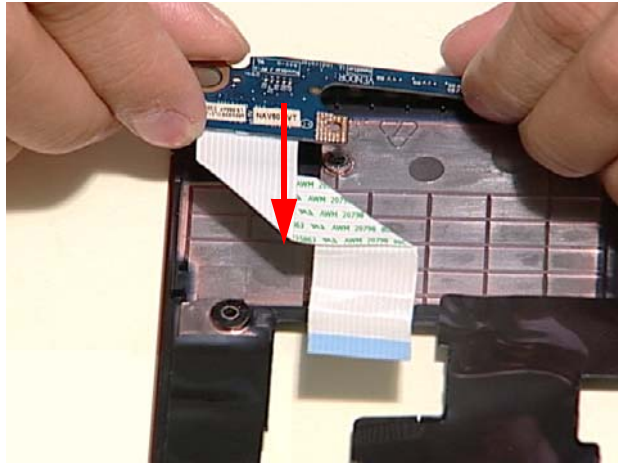

2. Secure the LED Board using one (1) screw.

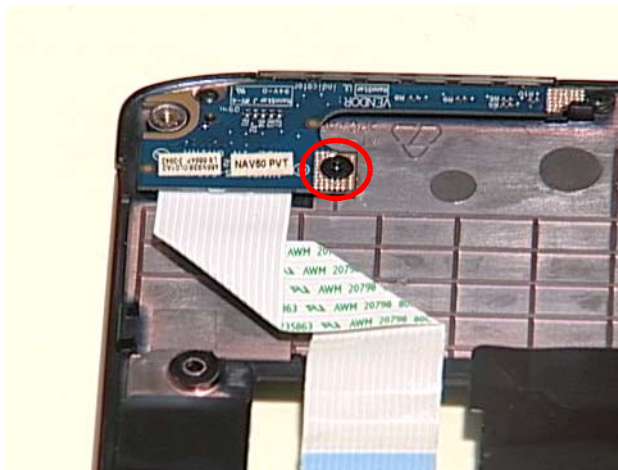

## Replacing the Touchpad Board

1. Place the Touchpad Board in the device, while pressing down on the FFC to adhere it to the Upper Cover.

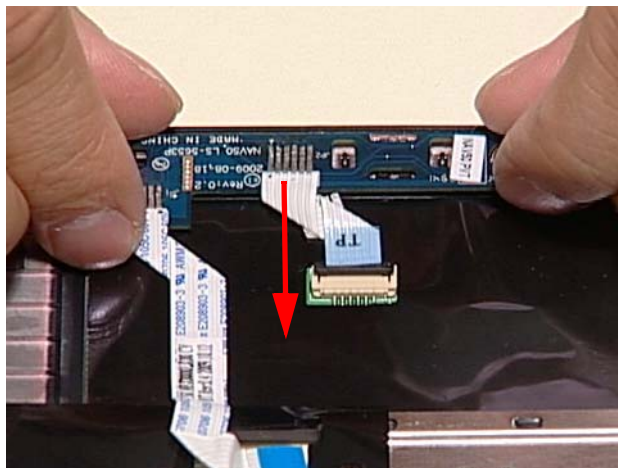



---

2. Secure the Touchpad Board using two (2) screws.

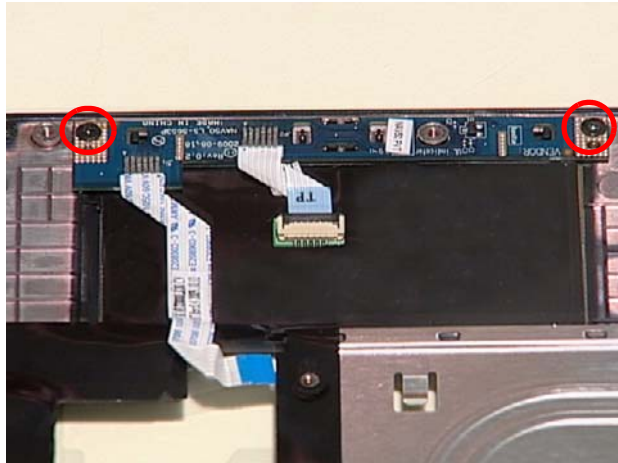

3. Connect the Touchpad cable and lock the connector.

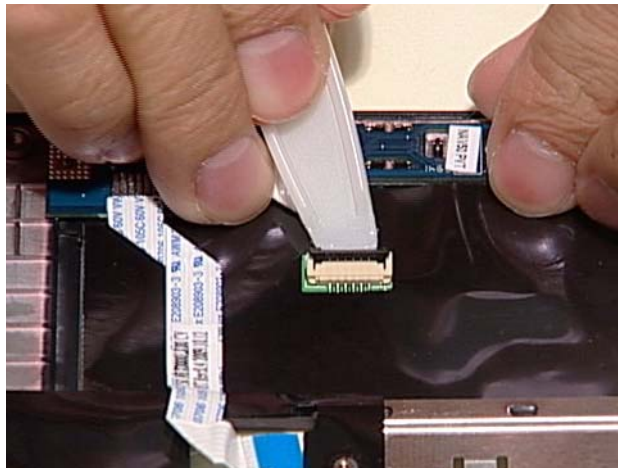

---

## Replacing the Upper Cover

1. Place the Upper Cover on the Lower Cover. Press down firmly to ensure that the covers are locked together.

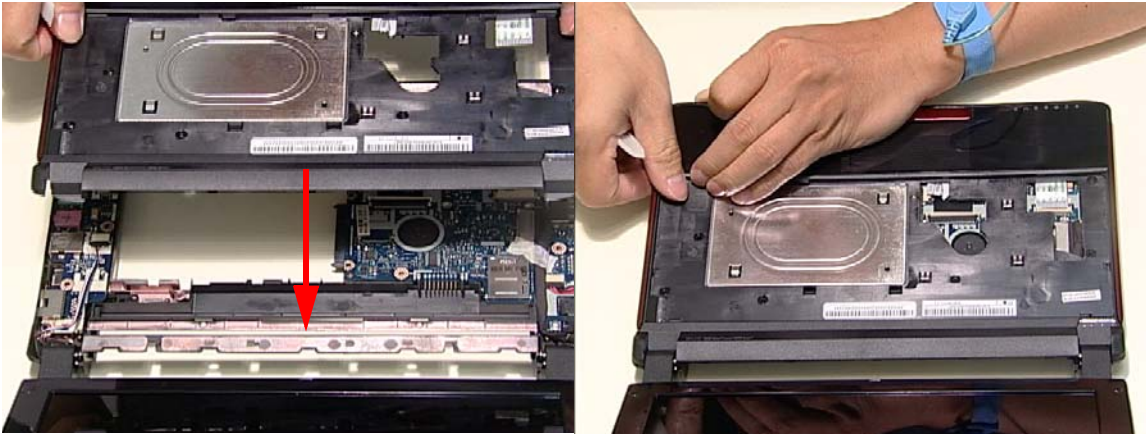

2. Secure the Upper Cover using seven (7) screws.



3. Reconnect the following cables to the Mainboard.

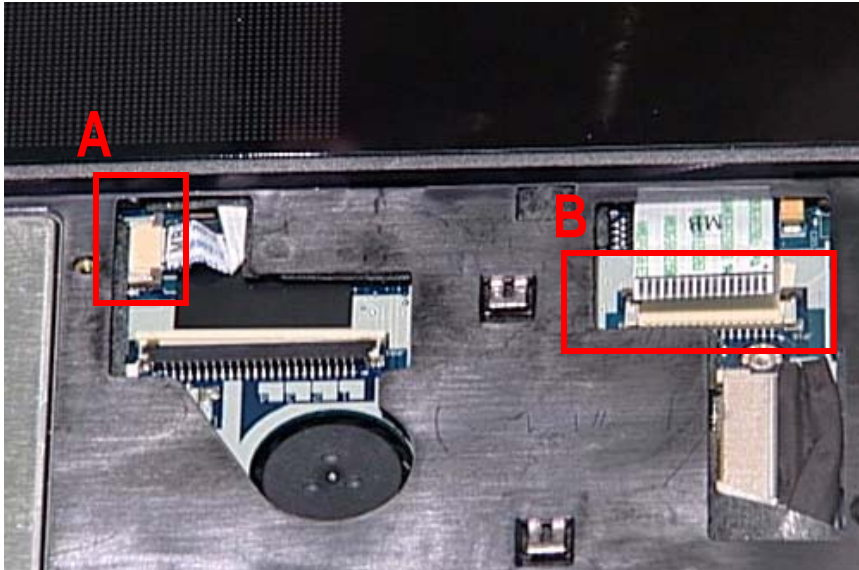

Connect A to the Mainboard.

Secure the locking latch on A as shown.

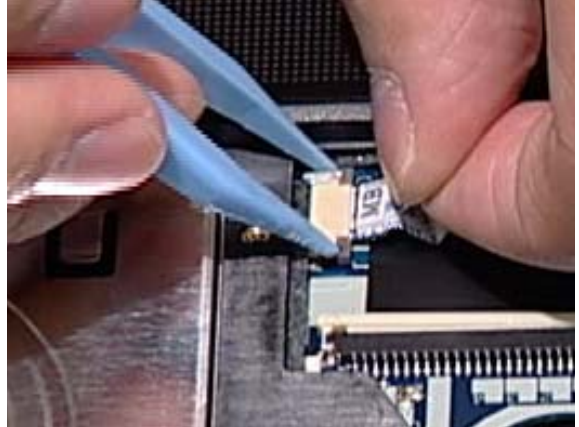
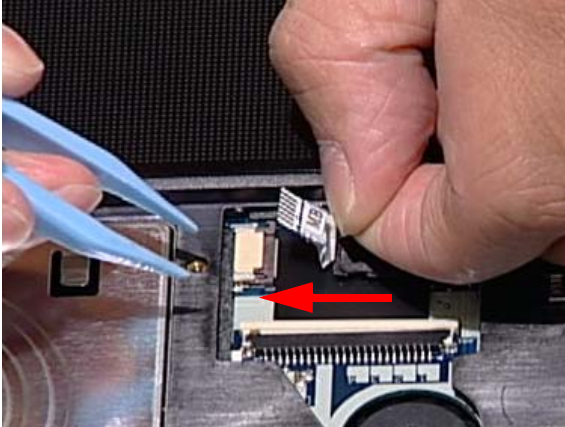

Connect B to the Mainboard.

Secure the locking latch on B as shown.

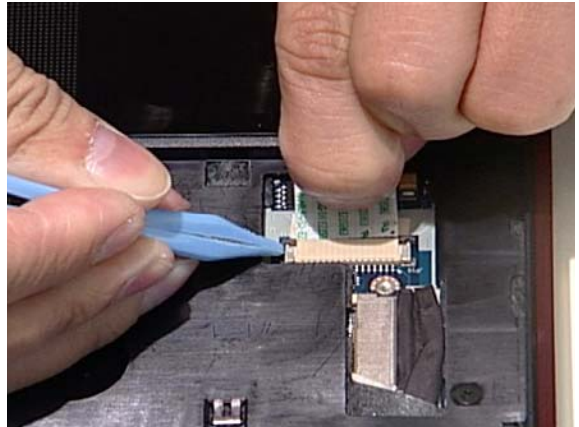
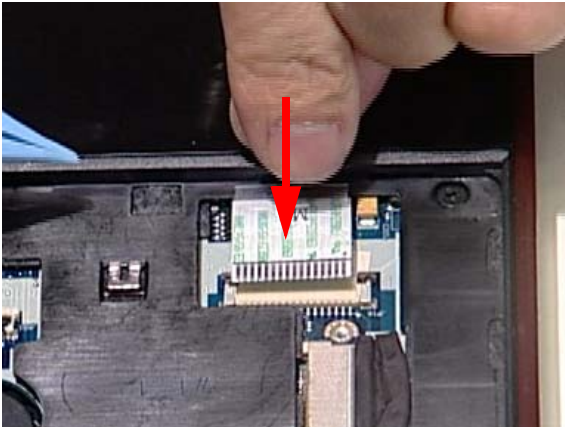

# Replacing the Keyboard

1. Turn the computer over. Insert the Keyboard FPC in to the Mainboard connector.
2. Close the FPC locking latch as shown.

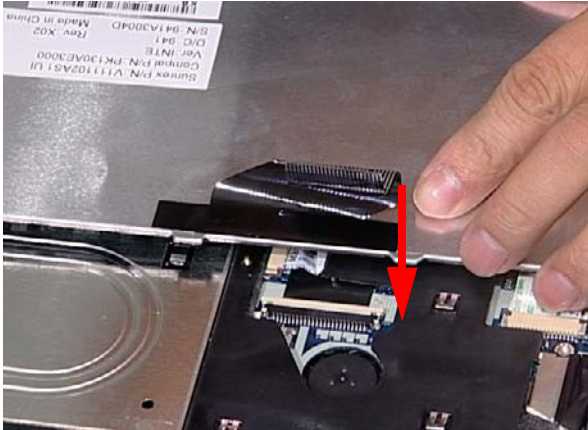

3. Turn the Keyboard over and slide it in the direction of the arrow. Press down around the edges of the Keyboard to engage the locking latches.

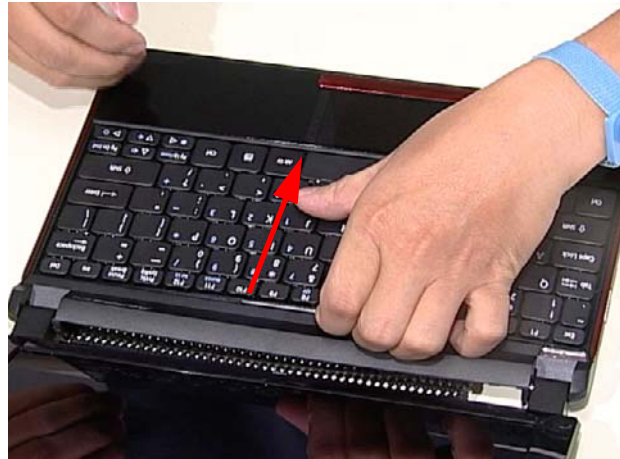

4. Secure the Back Cover using eleven (11) screws.

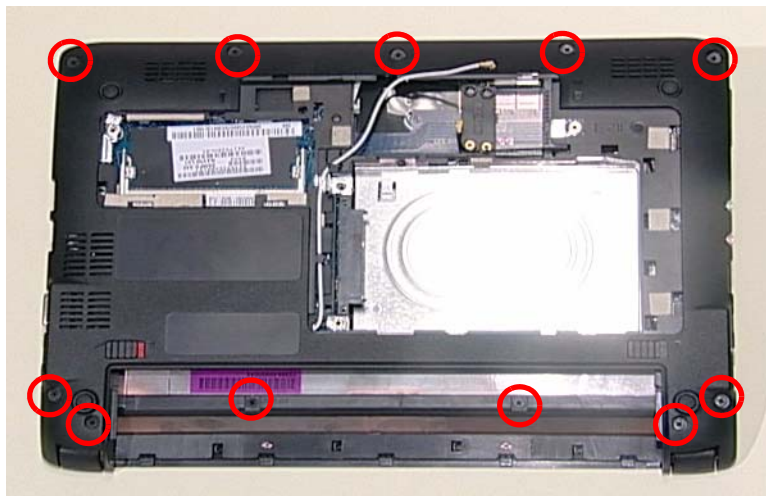

---

## Replacing the WLAN Module

1. Replace the WLAN card.

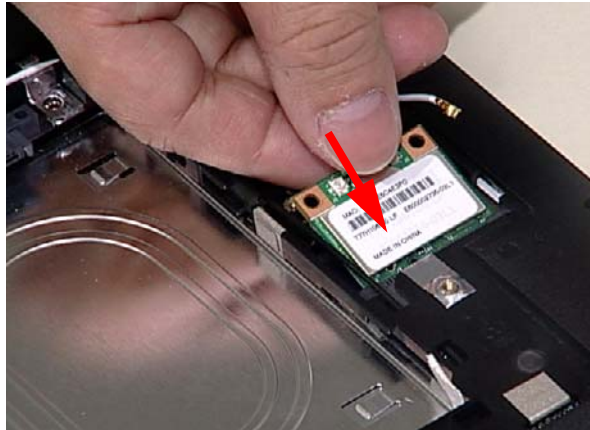

2. Secure the WLAN module using one (1) screw.

3. Connect two (2) antenna cables to the WLAN module.

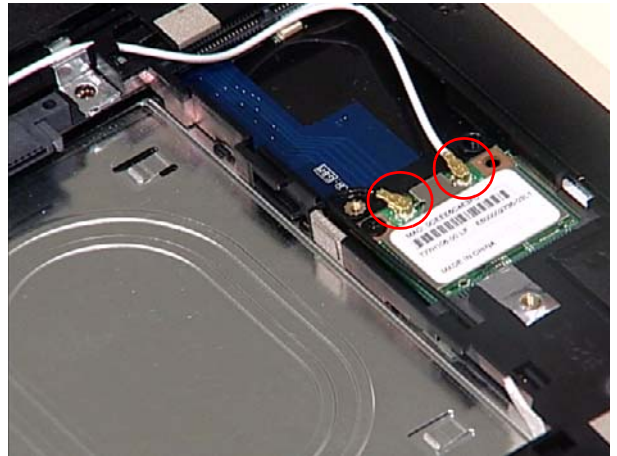

## Replacing the DIMM Module

1. Line the DIMMcard up with the slot.

2. Push the DIMM card down until there is an audible click.

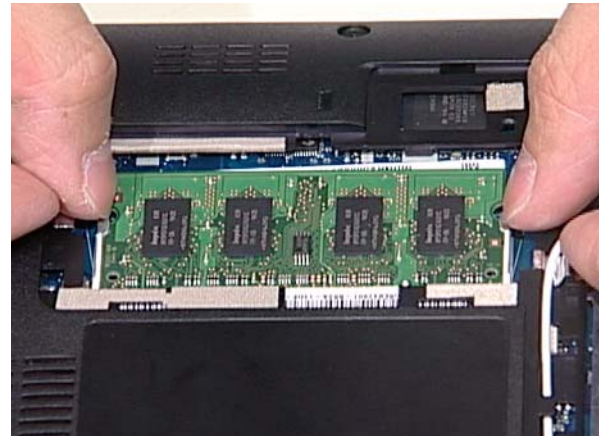
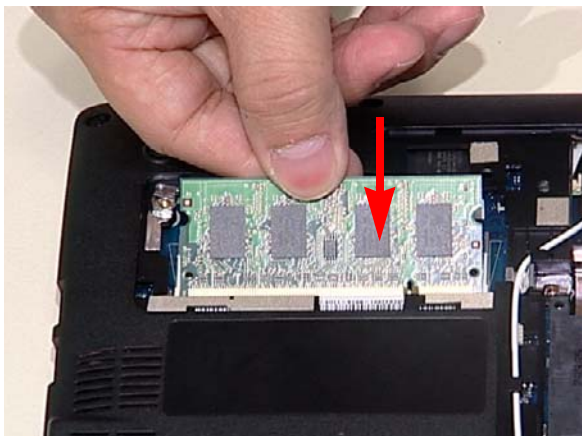

---

3. Replace the DIMM cover by first lining up the guide hooks on the top edge.

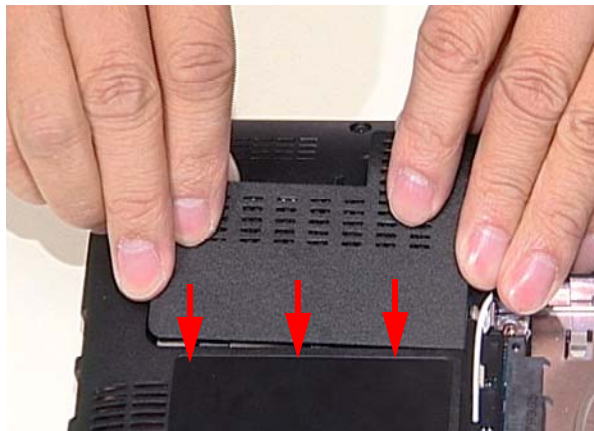

4. Press down on the cover to lock all guide hooks. The cover should be flush with the device.



5. Secure the DIMM cover using one (1) screw.



# Replacing the Hard Disk Drive Module

1. Insert the HDD in to the HDD Carrier and secure the Carrier to the HDD by replacing the four (4) screws.



2. Insert the HDD Module into the Lower Cover as shown.

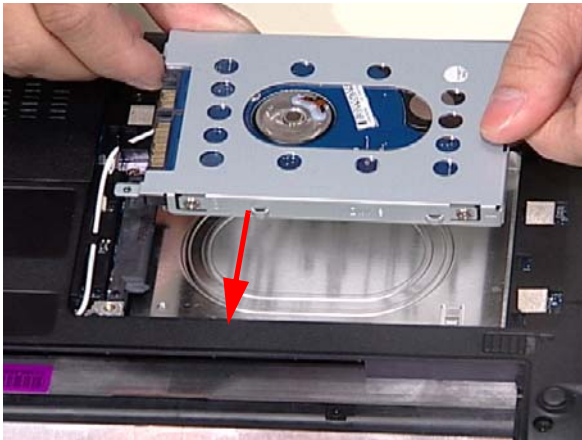

3. Slide the HDD Module in the direction of the arrow to connect the interface.

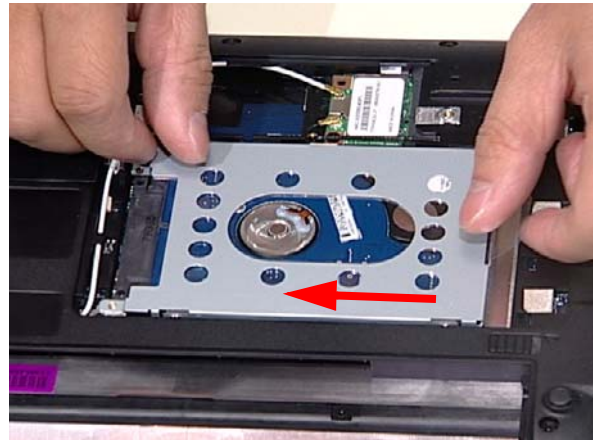

4. Replace the HDD door by lining up the guide hooks as shown.

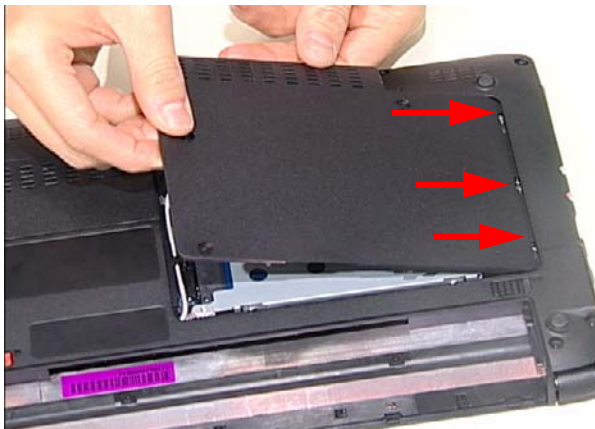

5. Remove the three (3) screws from the HDD Cover.

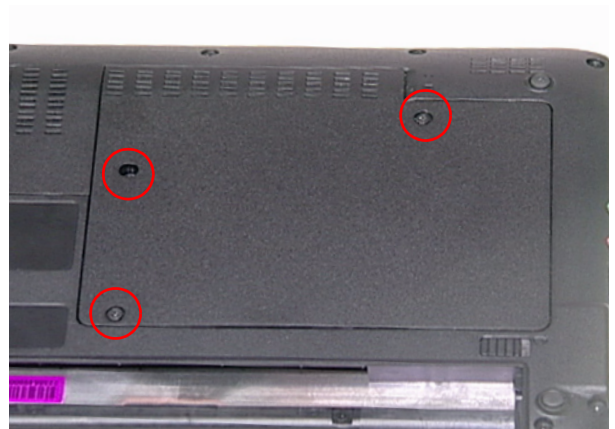

---

## Replacing the Battery Pack

1. Slide and hold the battery release latch to the release position (1), then insert the battery pack in to the main unit (2).
2. Slide the battery lock/unlock latch to the lock position.





# Troubleshooting

---

## Common Problems

Use the following procedure as a guide for computer problems.

**NOTE:** The diagnostic tests are intended to test only Acer products. Non-Acer products, prototype cards, or modified options can give false errors and invalid system responses.

1. Obtain the failing symptoms in as much detail as possible.
2. Verify the symptoms by attempting to re-create the failure by running the diagnostic test or by repeating the same operation.
3. Use the following table with the verified symptom to determine which page to go to.

| Symptoms (Verified)         | Go To    |
|-----------------------------|----------|
| Power On Issue              | Page 104 |
| No Display Issue            | Page 105 |
| LCD Failure                 | Page 107 |
| Internal Keyboard Failure   | Page 107 |
| TouchPad Failure            | Page 108 |
| Internal Speaker Failure    | Page 109 |
| Internal Microphone Failure | Page 111 |
| Rightside USB Failure       | Page 113 |
| Wireless Function Failure   | Page 114 |
| 3G Function Failure         | Page 115 |
| Switch Failure              | Page 116 |
| Thermal Units Failure       | Page 117 |
| Power Button Failure        | Page 117 |
| External Mouse Failure      | Page 118 |
| Other Functions Failure     | Page 118 |
| Intermittent Failures       | Page 119 |
| Undermined Failures         | Page 119 |

4. If the Issue is still not resolved, see "Online Support Information" on page 213.

---

## Power On Issue

If the system doesn't power on, perform the following actions one at a time to correct the problem. Do not replace non-defective FRUs:

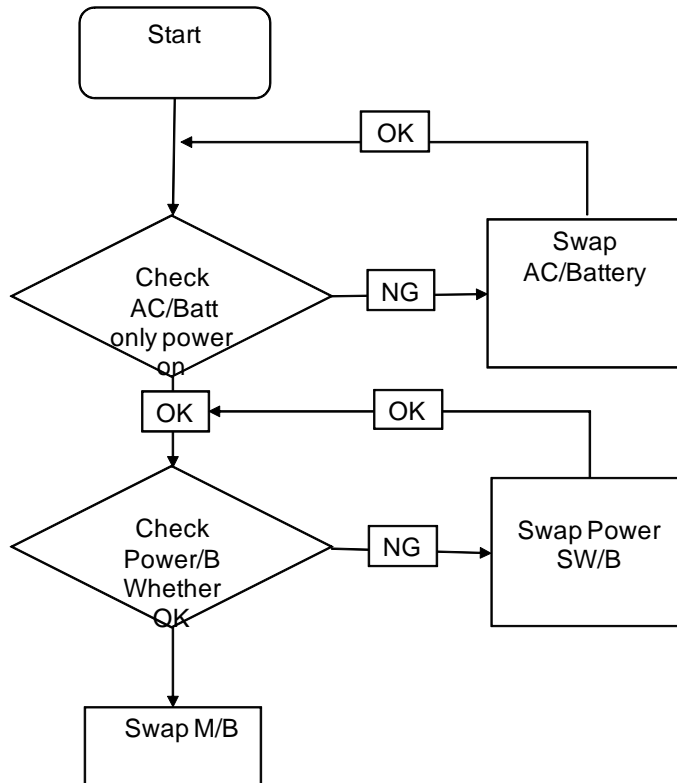

## Computer Shuts down Intermittently

If the system powers off at intervals, perform the following actions one at a time to correct the problem.

1. Check the power cable is properly connected to the computer and the electrical outlet.
2. Remove any extension cables between the computer and the outlet.
3. Remove any surge protectors between the computer and the electrical outlet. Plug the computer directly into a known good electrical outlet.
4. Remove all external and non-essential hardware connected to the computer that are not necessary to boot the computer to the failure point.
5. Remove any recently installed software.
6. If the Issue is still not resolved, see "Online Support Information" on page 213.

# No Display Issue

If the **Display** doesn't work, perform the following actions one at a time to correct the problem. Do not replace non-defective FRUs:

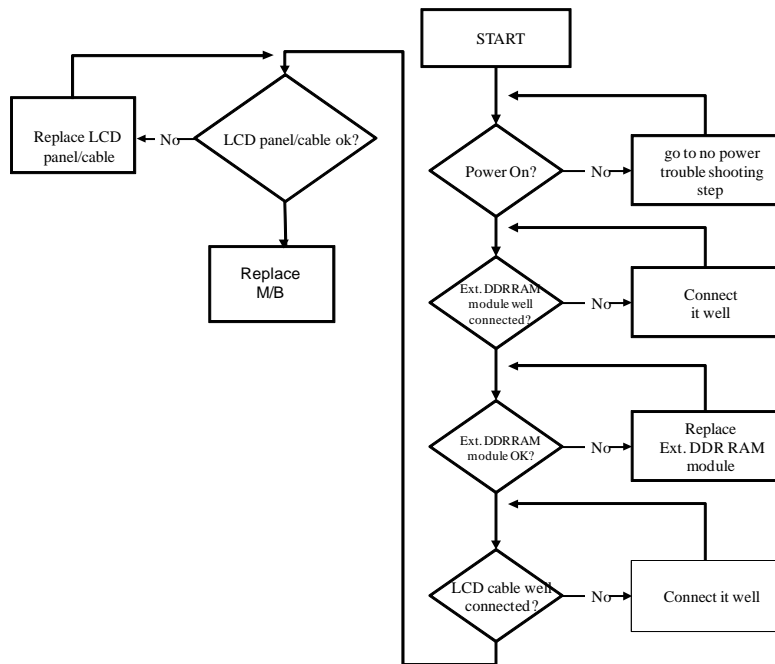

## No POST or Video

If the POST or video doesn't display, perform the following actions one at a time to correct the problem.

1. Make sure that the internal display is selected. On this notebook model, switching between the internal display and the external display is done by pressing **Fn+F5**. Reference Product pages for specific model procedures.
2. Make sure the computer has power by checking at least one of the following occurs:
  - Fans start up
  - Status LEDs light up

If there is no power, see "Power On Issue" on page 104.

3. Drain any stored power by removing the power cable and battery and holding down the power button for 10 seconds. Reconnect the power and reboot the computer.
4. Connect an external monitor to the computer and switch between the internal display and the external display is by pressing **Fn+F5** (on this model).

If the POST or video appears on the external display, see "LCD Failure" on page 107.

5. Disconnect power and all external devices including port replicators or docking stations. Remove any memory cards and CD/DVD discs. Restart the computer.

If the computer boots correctly, add the devices one by one until the failure point is discovered.

6. Reseat the memory modules.
7. Remove the drives (see "Disassembly Process" on page 40).
8. If the Issue is still not resolved, see "Online Support Information" on page 213.

---

## Abnormal Video Display

If video displays abnormally, perform the following actions one at a time to correct the problem.

1. Reboot the computer.
2. If permanent vertical/horizontal lines or dark spots display in the same location, the LCD is faulty and should be replaced. See “Disassembly Process” on page 40.
3. If extensive pixel damage is present (different colored spots in the same locations on the screen), the LCD is faulty and should be replaced. See “Disassembly Process” on page 40.
4. Adjust the brightness to its highest level. See the User Manual for instructions on adjusting settings.  
**NOTE:** Ensure that the computer is not running on battery alone as this may reduce display brightness.  
If the display is too dim at the highest brightness setting, the LCD is faulty and should be replaced. See “Disassembly Process” on page 40.
5. Check the display resolution is correctly configured:
  - a. Minimize or close all Windows.
  - b. If display size is only abnormal in an application, check the view settings and control/mouse wheel zoom feature in the application.
  - c. If desktop display resolution is not normal, right-click on the desktop and select **Personalize**→ **Display Settings**.
  - d. Click and drag the Resolution slider to the desired resolution.
  - e. Click **Apply** and check the display. Readjust if necessary.
6. Roll back the video driver to the previous version if updated.
7. Remove and reinstall the video driver.
8. Check the Device Manager to determine that:
  - The device is properly installed. There are no red Xs or yellow exclamation marks.
  - There are no device conflicts.
  - No hardware is listed under Other Devices.
9. If the Issue is still not resolved, see “Online Support Information” on page 213.
10. Run the Windows Memory Diagnostic from the operating system DVD and follow the onscreen prompts.
11. If the Issue is still not resolved, see “Online Support Information” on page 213.

## Random Loss of BIOS Settings

If the computer is experiencing intermittent loss of BIOS information, perform the following actions one at a time to correct the problem.

1. If the computer is more than one year old, replace the CMOS battery.
2. Run a complete virus scan using up-to-date software to ensure the computer is virus free.
3. If the computer is experiencing HDD or ODD BIOS information loss, disconnect and reconnect the power and data cables between devices.  
If the BIOS settings are still lost, replace the cables.
4. If HDD information is missing from the BIOS, the drive may be defective and should be replaced.
5. Replace the Motherboard.
6. If the Issue is still not resolved, see “Online Support Information” on page 213.

---

## LCD Failure

If the **LCD** fails, perform the following actions one at a time to correct the problem. Do not replace non-defective FRUs:

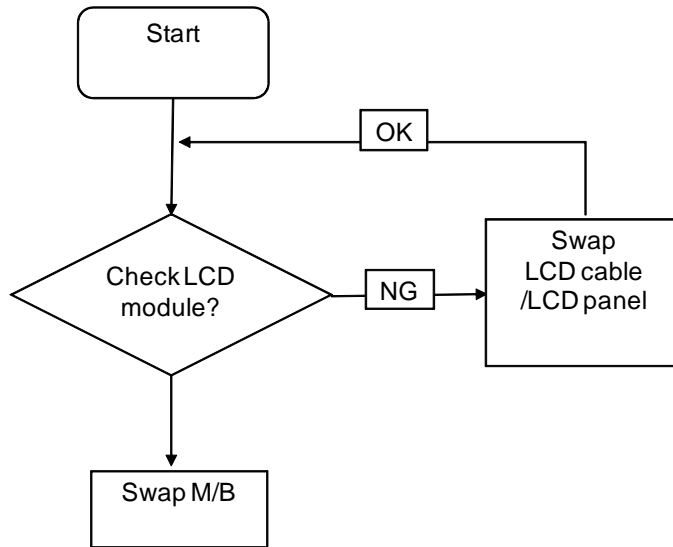

## Built-In Keyboard Failure

If the built-in **Keyboard** fails, perform the following actions one at a time to correct the problem. Do not replace non-defective FRUs:

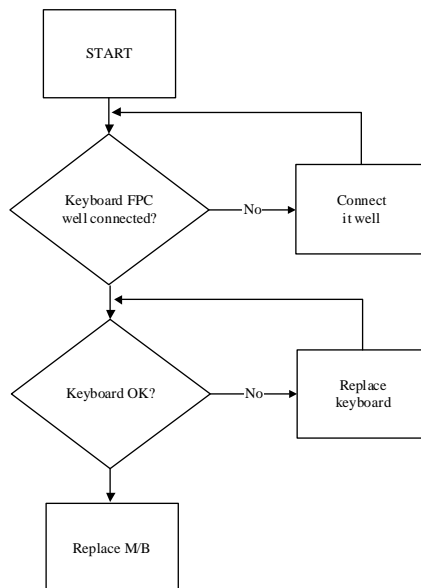

# TouchPad Failure

If the **TouchPad** doesn't work, perform the following actions one at a time to correct the problem. Do not replace non-defective FRUs:

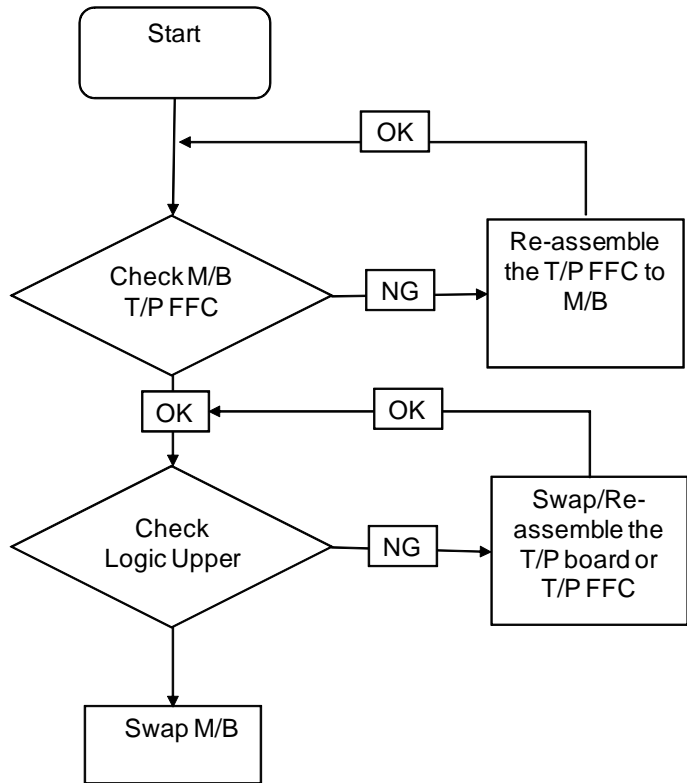

---

## Internal Speaker Failure

If the internal **Speakers** fail, perform the following actions one at a time to correct the problem. Do not replace non-defective FRUs:

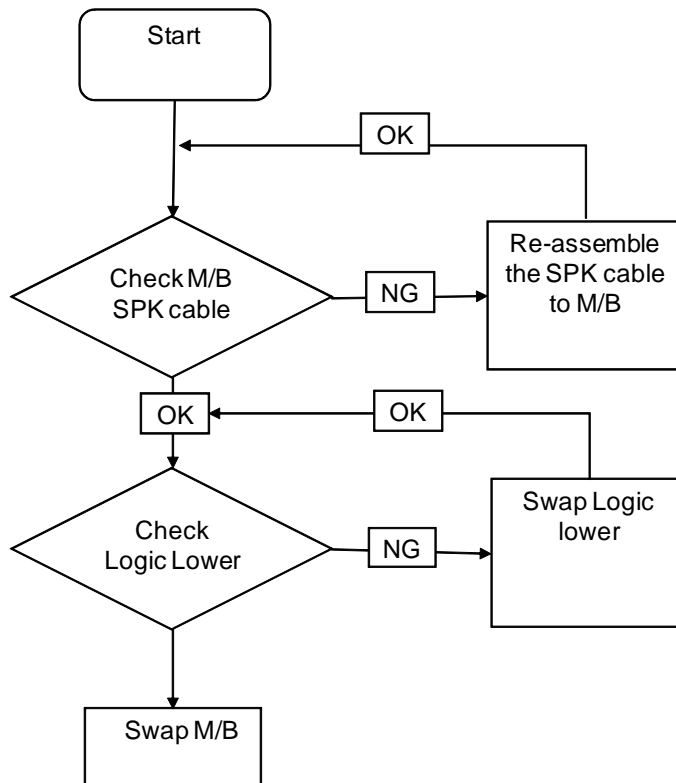

## Sound Problems

If sound problems are experienced, perform the following actions one at a time to correct the problem.

1. Reboot the computer.
2. Navigate to **Start** → **Control Panel** → **System and Maintenance** → **System** → **Device Manager**. Check the Device Manager to determine that:
  - The device is properly installed.
  - There are no red Xs or yellow exclamation marks.
  - There are no device conflicts.
  - No hardware is listed under Other Devices.
3. Roll back the audio driver to the previous version, if updated recently.
4. Remove and reinstall the audio driver.
5. Ensure that all volume controls are set mid range:
  - a. Click the volume icon on the taskbar and drag the slider to 50. Ensure that the volume is not muted.
  - b. Click Mixer to verify that other audio applications are set to 50 and not muted.
6. Navigate to **Start** → **Control Panel** → **Hardware and Sound** → **Sound**. Ensure that Speakers are selected as the default audio device (green check mark).

**NOTE:** If Speakers does not show, right-click on the **Playback** tab and select **Show Disabled Devices** (clear by default).
7. Select Speakers and click **Configure** to start **Speaker Setup**. Follow the onscreen prompts to configure the speakers.

- 
8. Remove and recently installed hardware or software.
  9. Restore system and file settings from a known good date using **System Restore**.  
If the issue is not fixed, repeat the preceding steps and select an earlier time and date.
  10. Reinstall the Operating System.
  11. If the Issue is still not resolved, see “Online Support Information” on page 213.



---

# Internal Microphone Failure

If the internal **Microphone** fails, perform the following actions one at a time to correct the problem. Do not replace non-defective FRUs:

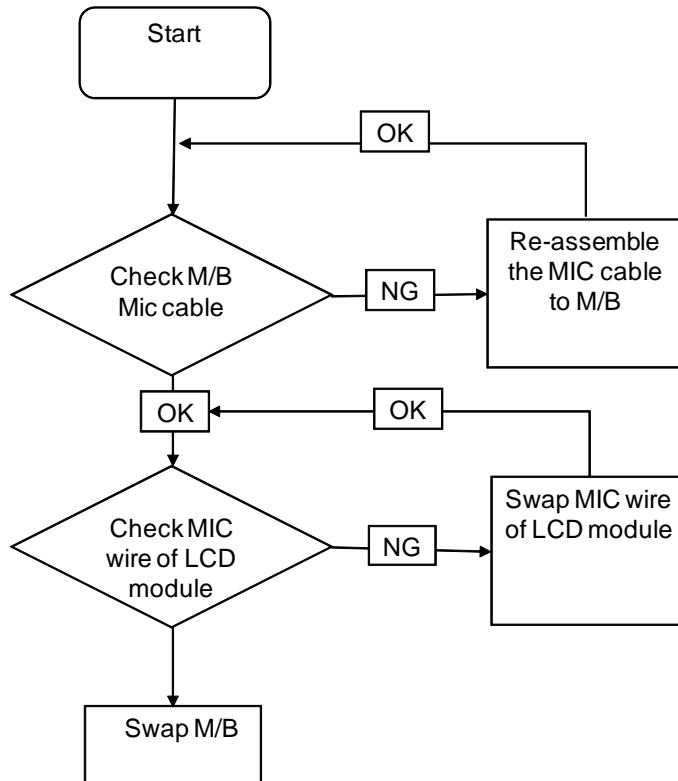

## Microphone Problems

If internal or external **Microphones** do not operate correctly, perform the following actions one at a time to correct the problem.

1. Check that the microphone is enabled. Navigate to **Start** → **Control Panel** → **Hardware and Sound** → **Sound** and select the **Recording** tab.
2. Right-click on the **Recording** tab and select **Show Disabled Devices** (clear by default).
3. The microphone appears on the **Recording** tab.
4. Right-click on the microphone and select **Enable**.
5. Select the microphone then click **Properties**. Select the **Levels** tab.
6. Increase the volume to the maximum setting and click **OK**.
7. Test the microphone hardware:
  - a. Select the microphone and click **Configure**.
  - b. Select **Set up microphone**.
  - c. Select the microphone type from the list and click **Next**.
  - d. Follow the onscreen prompts to complete the test.
8. If the Issue is still not resolved, see "Online Support Information" on page 213.

---

## HDD Not Operating Correctly

If the **HDD** does not operate correctly, perform the following actions one at a time to correct the problem.

1. Disconnect all external devices.
2. Run a complete virus scan using up-to-date software to ensure the computer is virus free.
3. Run the Windows Vista Startup Repair Utility:
  - a. insert the Windows Vista Operating System DVD in the ODD and restart the computer.
  - b. When prompted, press any key to start to the operating system DVD.
  - c. The **Install Windows** screen displays. Click **Next**.
  - d. Select **Repair your computer**.
  - e. The **System Recovery Options** screen displays. Click **Next**.
  - f. Select the appropriate operating system, and click **Next**.

**NOTE:** Click **Load Drivers** if controller drives are required.

- g. Select **Startup Repair**.
- h. Startup Repair attempts to locate and resolve issues with the computer.
- i. When complete, click **Finish**.

If an issue is discovered, follow the onscreen information to resolve the problem.

4. Run the Windows Memory Diagnostic Tool. For more information see Windows Help and Support.
5. Restart the computer and press F2 to enter the BIOS Utility. Check the BIOS settings are correct and that CD/DVD drive is set as the first boot device on the Boot menu.
6. Ensure all cables and jumpers on the HDD and ODD are set correctly.
7. Remove any recently added hardware and associated software.
8. Run the Windows Disk Defragmenter. For more information see Windows Help and Support.
9. Run Windows Check Disk by entering **chkdsk /r** from a command prompt. For more information see Windows Help and Support.
10. Restore system and file settings from a known good date using **System Restore**.

If the issue is not fixed, repeat the preceding steps and select an earlier time and date.
11. Replace the HDD. See "Disassembly Process" on page 40.

---

## USB Failure (Rightside)

If the rightside **USB** port fails, perform the following actions one at a time to correct the problem. Do not replace non-defective FRUs:

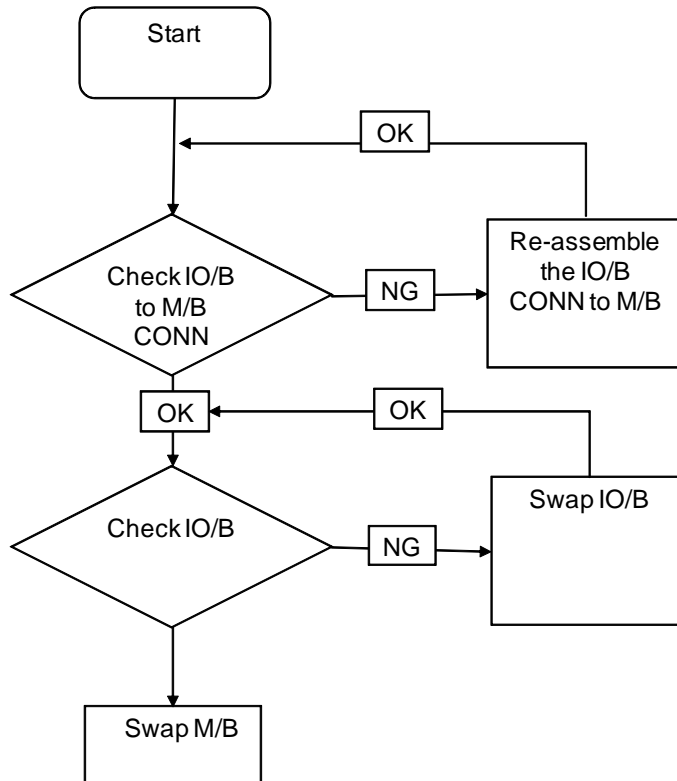

# Wireless Function Test Failure

If the wireless function test fails, perform the following actions one at a time to correct the problem. Do not replace non-defective FRUs:

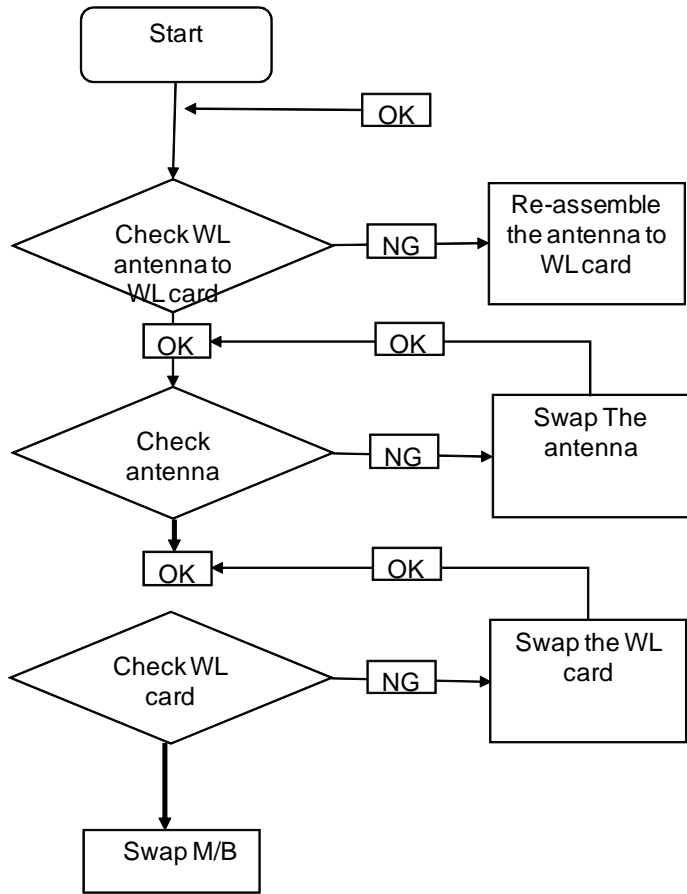

# 3G Function Test Failure

If the 3G function test fails, perform the following actions one at a time to correct the problem. Do not replace non-defective FRUs:

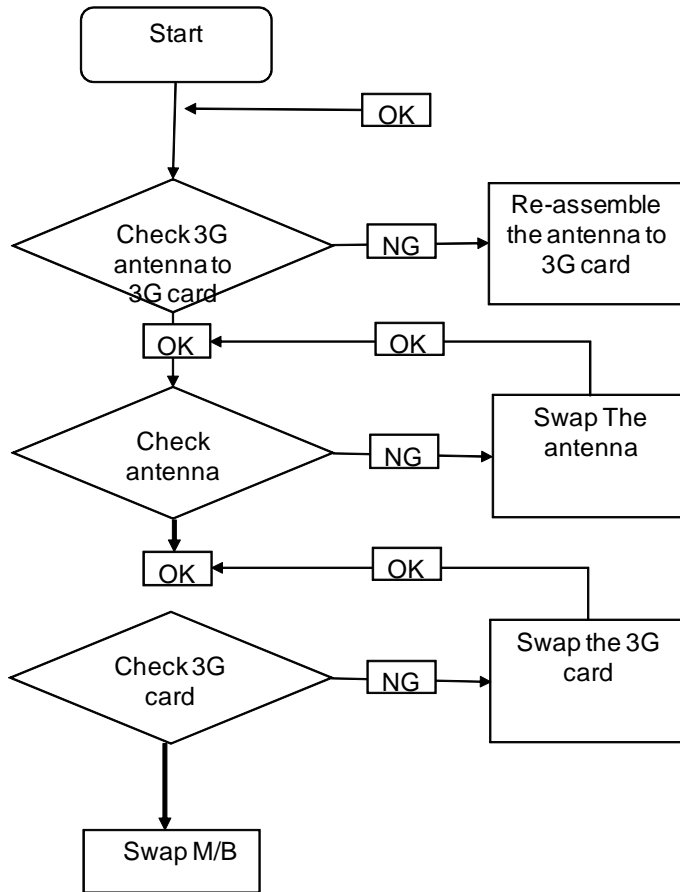

# Switch Failure

If the switches fail, perform the following actions one at a time to correct the problem. Do not replace non-defective FRUs:

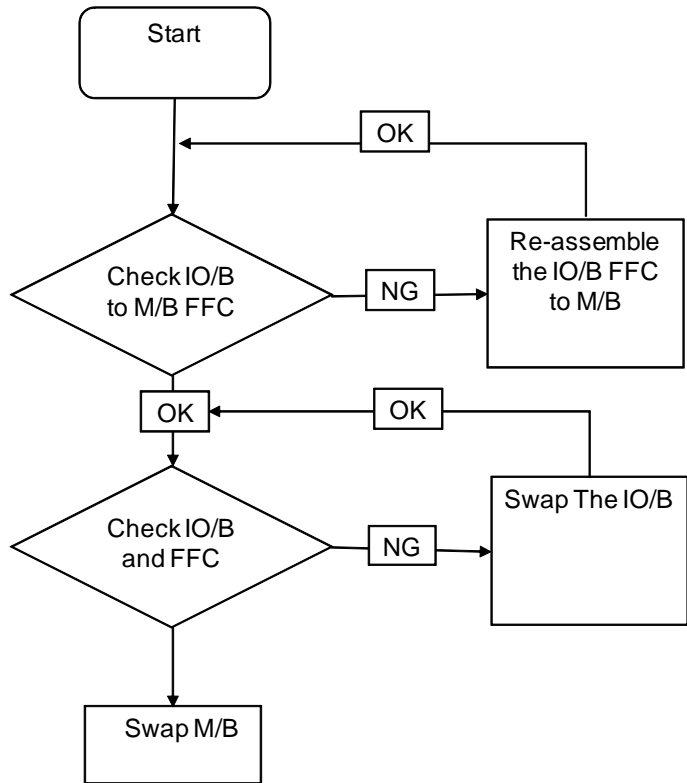

# Thermal Units Failure

If the thermal units fail, perform the following actions one at a time to correct the problem. Do not replace non-defective FRUs:

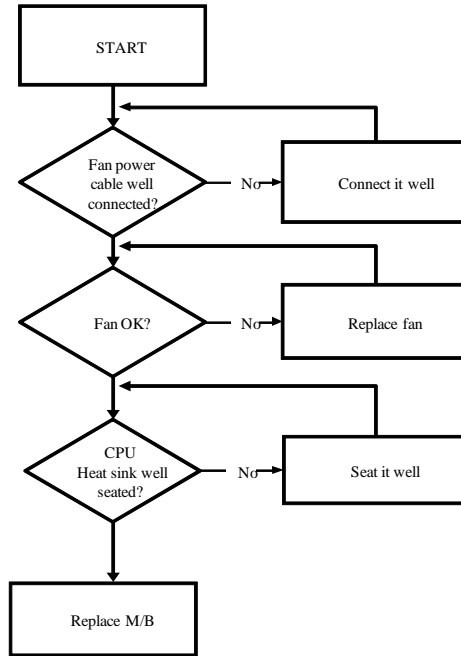

# Power Button Failure

If the Power Button fails, perform the following actions one at a time to correct the problem. Do not replace non-defective FRUs:

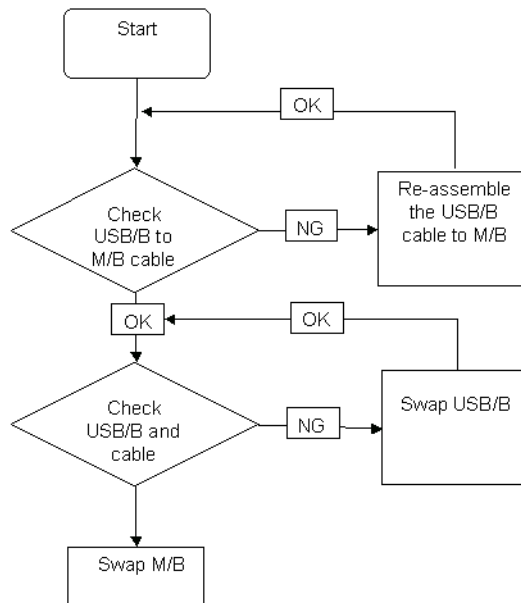

---

## External Mouse Failure

If an external **Mouse** fails, perform the following actions one at a time to correct the problem.

1. Try an alternative mouse.
2. If the mouse uses a wireless connection, insert new batteries and confirm there is a good connection. See the mouse user manual.
3. If the mouse uses a USB connection, try an alternate USB port.
4. Try an alternative program to verify mouse operation. Reinstall the program experiencing mouse failure.
5. Restart the computer.
6. Remove any recently added hardware and associated software.
7. Remove any recently added software and reboot.
8. Restore system and file settings from a known good date using **System Restore**.  
If the issue is not fixed, repeat the preceding steps and select an earlier time and date.
9. Run the Event Viewer to check the events log for errors. For more information see Windows Help and Support.
10. Roll back the mouse driver to the previous version if updated recently.
11. Remove and reinstall the mouse driver.
12. Check the Device Manager to determine that:
  - The device is properly installed. There are no red Xs or yellow exclamation marks.
  - There are no device conflicts.
  - No hardware is listed under Other Devices.
13. If the Issue is still not resolved, see "Online Support Information" on page 213.

## Other Failures

If the CRT Switch, Dock, LAN Port, external MIC or Speakers, PCI Express Card, 5-in-1 Card Reader or Volume Wheel fail, perform the following general steps to correct the problem. Do not replace non-defective FRUs:

1. Check Drive whether is OK.
2. Check Test Fixture is ok.
3. Swap M/B to Try.



---

# Intermittent Problems

Intermittent system hang problems can be caused by a variety of reasons that have nothing to do with a hardware defect, such as: cosmic radiation, electrostatic discharge, or software errors. FRU replacement should be considered only when a recurring problem exists.

When analyzing an intermittent problem, do the following:

1. Run the advanced diagnostic test for the system board in loop mode at least 10 times.
2. If no error is detected, do not replace any FRU.
3. If any error is detected, replace the FRU. Rerun the test to verify that there are no more errors.

# Undetermined Problems

The diagnostic problems does not identify which adapter or device failed, which installed devices are incorrect, whether a short circuit is suspected, or whether the system is inoperative.

Follow these procedures to isolate the failing FRU (do not isolate non-defective FRU).

**NOTE:** Verify that all attached devices are supported by the computer.

**NOTE:** Verify that the power supply being used at the time of the failure is operating correctly. (See “Power On Issue” on page 104):

1. Power-off the computer.
2. Visually check them for damage. If any problems are found, replace the FRU.
3. Remove or disconnect all of the following devices:
  - Non-Acer devices
  - Printer, mouse, and other external devices
  - Battery pack
  - Hard disk drive
  - DIMM
  - CD-ROM/Diskette drive Module
  - PC Cards
4. Power-on the computer.
5. Determine if the problem has changed.
6. If the problem does not recur, reconnect the removed devices one at a time until you find the failing FRU.
7. If the problem remains, replace the following FRU one at a time. Do not replace a non-defective FRU:
  - System board
  - LCD assembly

---

# Motherboard CMOS Discharge

If any problems such as incorrect CMOS settings, the CMOS data can be cleared by short-circuiting the CMOS jumpers. Remove the Back Cover and use a metal conductivity tool to short-circuit the jumpers near the DIMM Module.



---

# POST Code Reference Tables

These tables describe the POST codes and components of the POST process.

## Sec:

NO\_EVICTION\_MODE\_DEBUG EQU 1 (CommonPlatform\sec\ia32\SecCore.inc)

| Code | Description   |
|------|---|
| 0xC2 | MTRR setup  |
| 0xC3 | Enable cache  |
| 0xC4 | Establish cache tags  |
| 0xC5 | Enter NEM, Place the BSP in No Fill mode, set CR0.CD = 1, CR0.NW = 0. |
| 0xCF | Cache Init Finished   |

## Memory:

DEBUG\_BIOS equ 1 (Chipset\Alviso\MemoryInitAsm\IA32\IMEMORY.INC)

| Code | Description  |
|------|--|
| 0xA0 | First memory check point   |
| 0x01 | Enable MCHBAR  |
| 0x02 | Check for DRAM initialization interrupt and reset fail   |
| 0x03 | Verify all DIMMs are DDR or DDR2 and unbuffered  |
| 0x04 | Detect an improper warm reset and handle   |
| 0x05 | Detect if ECC SO-DIMMs are present in the system   |
| 0x06 | Verify all DIMMs are single or double sided and not asymmetric   |
| 0x07 | Verify all DIMMs are x8 or x16 width   |
| 0x08 | Find a common CAS latency between the DIMMS and the MCH  |
| 0x09 | Determine the memory frequency and CAS latency to program  |
| 0x10 | Determine the smallest common TRAS for all DIMMs   |
| 0x11 | Determine the smallest common TRP for all DIMMs  |
| 0x12 | Determine the smallest common TRCD for all DIMMs   |
| 0x13 | Determine the smallest refresh period for all DIMMs  |
| 0x14 | Verify burst length of 8 is supported by all DIMMs   |
| 0x15 | Determine the smallest tWR supported by all DIMMs  |
| 0x16 | Determine DIMM size parameters   |
| 0x17 | Program the correct system memory frequency  |
| 0x18 | Determine and set the mode of operation for the memory channels  |
| 0x19 | Program clock crossing registers   |
| 0x20 | Disable Fast Dispatch  |
| 0x21 | Program the DRAM Row Attributes and DRAM Row Boundary registers  |
| 0x22 | Program the DRAM Bank Architecture register  |
| 0x23 | Program the DRAM Timing & and DRAM Control registers   |
| 0x24 | Program ODT  |
| 0x25 | Perform steps required before memory init  |
| 0x26 | Program the receive enable reference timing control register<br>Program the DLL Timing Control Registers, RCOMP settings |

| Code | Description   |
|------|---|
| 0x27 | Enable DRAM Channel I/O Buffers                             |
| 0x28 | Enable all clocks on populated rows                         |
| 0x29 | Perform JEDEC memory initialization for all memory rows     |
| 0x30 | Perform steps required after memory init                    |
| 0x31 | Program DRAM throttling and throttling event registers      |
| 0x32 | Setup DRAM control register for normal operation and enable |
| 0x33 | Enable RCOMP  |
| 0x34 | Clear DRAM initialization bit in the SB                     |
| 0x35 | Initialization Sequence Completed, program graphic clocks   |
| 0x43 | Program Thermal Throttling                                  |

## BDS & Specific action:

| Code | Description  |
|------|--|
| 0x00 | Report the legacy boot is happening                              |
| 0x12 | Wake up the Aps  |
| 0x13 | Initialize SMM Private Data and relocate BSP SMBASE              |
| 0x21 | PC init begin at the stage1                                      |
| 0x27 | Report every memory range do the hard ware ECC init              |
| 0x28 | Report status code of every memory range                         |
| 0x50 | Get the root bridge handle                                       |
| 0x51 | Notify pci bus driver starts to program the resource             |
| 0x58 | Reset the host controller  |
| 0x5A | IdeBus begin initialization                                      |
| 0x79 | Report that the remote terminal is being disabled                |
| 0x7A | Report that the remote terminal is being enabled                 |
| 0x90 | Keyboard reset   |
| 0x91 | USB Keyboard disable   |
| 0x92 | Keyboard detection   |
| 0x93 | Report that the usb keyboard is being enabled                    |
| 0x94 | Clear the keyboard buffer  |
| 0x95 | Init Keyboard  |
| 0x98 | Mouse reset  |
| 0x99 | Mouse disable  |
| 0x9A | Detect PS2 mouse   |
| 0x9B | Report that the mouse is being enabled                           |
| 0xB8 | Peripheral removable media reset (ex: IsaFloppy, USB device)     |
| 0xB9 | Peripheral removable media disable                               |
| 0xBB | Peripheral removable media enable                                |
| 0xE4 | Report Status Code here for DXE_ENTRY_POINT once it is available |
| 0xF8 | Report that ExitBootServices () has been called                  |
| 0xF9 | Runtime driver set virtual address map                           |

## Each PEIM entry point used in 80\_PORT

| Code      | Description               |
|-----------|---------------------------|
| 0x00      |                           |
| 0x01      | PEI_EVENT_LOG             |
| 0xA1      | PEI_OEM_SERVICE           |
| 0xA2      | PEI_SIO_INIT              |
| 0xA3      | PEI_MONO_STATUS_CODE      |
| 0xA4      | PEI_CPU_IO_PCI_CFG        |
| 0x06      | PEI_CPU_IO                |
| 0x07      | PEI_PCI_CFG               |
| 0xA5      | PEI_CPU_PEIM              |
| 0xA6      | PEI_PLATFORM_STAGE1       |
| 0xA7      | PEI_VARIABLE              |
| 0xA8      | PEI_SB_INIT               |
| 0x0C      | PEI_CAPSULE               |
| 0xAA      | PEI_PLATFORM_STAGE2       |
| 0xAC      | PEI_SB_SMBUS_ARP_DISABLED |
| 0x0F      | PEI_HOST_TO_SYSTEM        |
| 0x40      | PEI_MEMORY_INIT           |
| 0x41      | PEI_S3_RESUME             |
| 0xAD      | PEI_CLOCK_GEN             |
| 0xAB      | PEI_OP_PRESENCE           |
| 0xAE      | PEI_FIND_FV               |
| 0x16      | PEI_H2O_DEBUG_IO          |
| 0x17      | PEI_H2O_DEBUG_COMM        |
| 0x16~0x1F | PEI_RESERVED              |
| 0x20~0x2E | PEI_OEM_DEFINED           |
| 0xAF      | PEI_DXE_IPL               |

## Each Driver entry point used in 80\_PORT

| Code | Description               |
|------|---------------------------|
| 0x30 | RESERVED                  |
| 0xB6 | DXE_CRC32_SECTION_EXTRACT |
| 0xB8 | SCRIPT_SAVE               |
| 0xB9 | ACPI_S3_SAVE              |
| 0xBA | SMART_TIMER               |
| 0xBB | JPEG_DECODER              |
| 0xBC | PCX_DECODER               |
| 0xBE | HT_CPU / MP_CPU           |
| 0xBF | LEGACY_METRONOME          |
| 0xC0 | FTWLITE                   |
| 0xC1 | RUN_RIME                  |
| 0xC2 | MONOTONIC_COUNTER         |
| 0xC3 | WATCH_DOG_TIMER           |

| Code | Description                         |
|------|-------------------------------------|
| 0xC4 | SECURITY_STUB                       |
| 0xC5 | DXE_CPU_IO                          |
| 0xC6 | CF9_RESET                           |
| 0xC7 | PC_RTC                              |
| 0xC8 | STATUS_CODE                         |
| 0xC9 | VARIABLE<br>EMU_VARIABLE            |
| 0xD9 | DXE_CHIPSET_INIT                    |
| 0x45 | DXE_ALERT_FORMAT                    |
| 0xD6 | PCI_HOST_BRIDGE                     |
| 0xD7 | PCI_EXPRESS                         |
| 0xD5 | DXE_SB_INIT                         |
| 0xDA | IDE_CONTROLLER                      |
| 0xDB | SATA_CONTROLLER                     |
| 0xDD | SB_SM_BUS                           |
| 0xE7 | ISA_ACPI_DRIVER                     |
| 0xE8 | ISA_BUS                             |
| 0xE9 | ISA_SERIAL                          |
| 0xED | BUS_PCI_UNDI                        |
| 0xEC | PCI_BUS                             |
| 0xF6 | BOOT_PRIORITY                       |
| 0xF7 | FVB_SERVICE                         |
| 0xF8 | ACPI_PLATFORM                       |
| 0xFB | PCI_HOT_PLUG                        |
| 0xFC | DXE_PLATFORM                        |
| 0xFD | PLATFORM_IDE                        |
| 0x97 | SMBIOS                              |
| 0x98 | MEMORY_SUB_CLASS                    |
| 0x99 | MISC_SUB_CLASS                      |
| 0x82 | CON_PLATFORM                        |
| 0x83 | SAVE_MEMORY_CONFIG                  |
| 0x84 | ACPI_SUPPORT                        |
| 0x85 | CON_SPLITTER_UGA_VGA / CON_SPLITTER |
| 0x88 | VGA_CLASS                           |
| 0x89 | DATA_HUB                            |
| 0x60 | DISK_IO                             |
| 0x8B | MEMORY_TEST                         |
| 0x62 | CRISIS_RECOVERY                     |
| 0x8D | LEGACY_8259                         |
| 0x8E | LEGACY_REGION                       |
| 0x8F | LEGACY_INTERRUPT                    |
| 0x70 | BIOS_KEYBOARD                       |
| 0x71 | BIOS_VEDIO                          |

| Code | Description                          |
|------|--------------------------------------|
| 0x72 | MONITER_KEY                          |
| 0x73 | LEGACY_BIOS                          |
| 0x75 | LEGACY_BIOS_PLATFORM                 |
| 0x76 | PCI_PLATFORM                         |
| 0x6C | ISA_FLOOPY                           |
| 0x6D | PS2_MOUSE                            |
| 0x6E | USB_BOT                              |
| 0x6F | USB_CBI0                             |
| 0x74 | USB_MOUSE                            |
| 0xFA | SETUP_UTILITY                        |
| 0x90 | FW_BLOCK_SERVICE                     |
| 0x78 | SMM_USB_LEGACY                       |
| 0x86 | GRAPHICS_CONSOLE                     |
| 0x87 | TERMINAL                             |
| 0x8A | DATA_HUB_STD_ERR                     |
| 0x7C | FAT                                  |
| 0x7D | PARTITION                            |
| 0x7E | ENGLISH                              |
| 0x7F | FRENCH                               |
| 0x9E | HII_DATABASE                         |
| 0x9F | OEM_SETUP_BROWSER                    |
| 0x8C | OEM_BADGING_SUPPORT                  |
| 0xF9 | SETUP_MOUSE                          |
| 0x72 | MONITOR_KEY                          |
| 0xBD | PLATFORM_BDS                         |
| 0x8D | RESERVED                             |
| 0x8E | RESERVED                             |
| 0x8F | RESERVED                             |
| 0xA0 | DXE_H2O_DEBUG_IO                     |
| 0xB3 | DXE_TPM_TCG                          |
| 0xB4 | DXE_TPM_PHYSICAL_PRESENCE            |
| 0xB7 | DXE_OEM_SERVICE                      |
| 0x9B | DXE_SECURITY_HDD_PASSWORD_SERVICE    |
| 0xA9 | DXE_LAN_IDER_CONTROLLER              |
| 0x9C | DXE_SECURITY_SYSTEM_PASSWORD_SERVICE |
| 0x9D | DXE_SECURITY_PASSWORD_CONSOLE        |
| 0xCB | DXE_DATA_HUB_RECORD_POLICY           |
| 0xB5 | DXE_TPM_DRIVER                       |
| 0x11 | CHINESE                              |
| 0xB0 | JAPANESE                             |
| 0xB1 | DXE_UNICODE_COLLATION                |

---

## Each SmmDriver entry point used in 80\_PORT

| Code | Description          |
|------|----------------------|
| 0xD4 | SMM_ACCESS           |
| 0xDE | SMM_CONTROL          |
| 0xCC | SMM_BASE             |
| 0xD2 | SMM_RUNTIME          |
| 0xDF | SB_SMM_DISPATCH      |
| 0xD0 | SMM_THUNK            |
| 0xCA | SMM_ACPI_SW_CHILD    |
| 0xFE | SMM_PLATFORM         |
| 0xD8 | SMM_GMCH_MBI         |
| 0x90 | SMM_FW_BLOCK_SERVICE |
| 0x91 | SMM_VARIABLE         |
| 0x92 | SMM_IHISI            |
| 0x93 | SMM_INT15_MICROCODE  |
| 0x94 | SMM_PNP              |
| 0x95 | SMM_INIT_PPM         |
| 0xD3 | SMM_OEM_SERVICE      |





# Jumper and Connector Locations

## Mainboard Top View

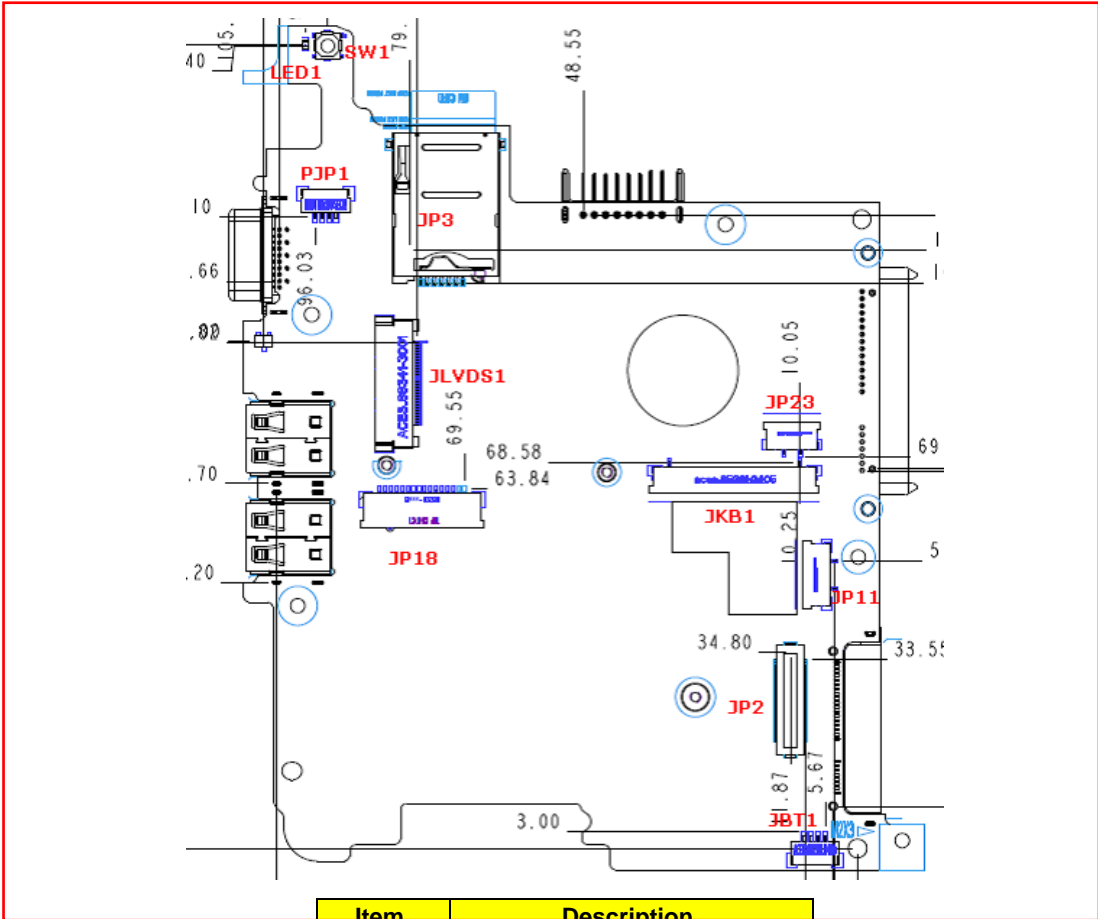

| Item  | Description                 |
|-------|-----------------------------|
| SW1   | NAV50 Power Button          |
| LED1  | NAV50 Power LED             |
| PJP1  | AC-IN Jack                  |
| JP3   | SIM Connector               |
| JLVD1 | LCD Connector               |
| JP18  | LED/B Connector             |
| JP23  | NAV60 Power/B Connector     |
| JKB1  | Internal Keyboard Connector |
| JP11  | T/P Connector               |
| JP2   | Bridge/B Connector          |
| JBT1  | B/T connector               |

# Mainboard Bottom View

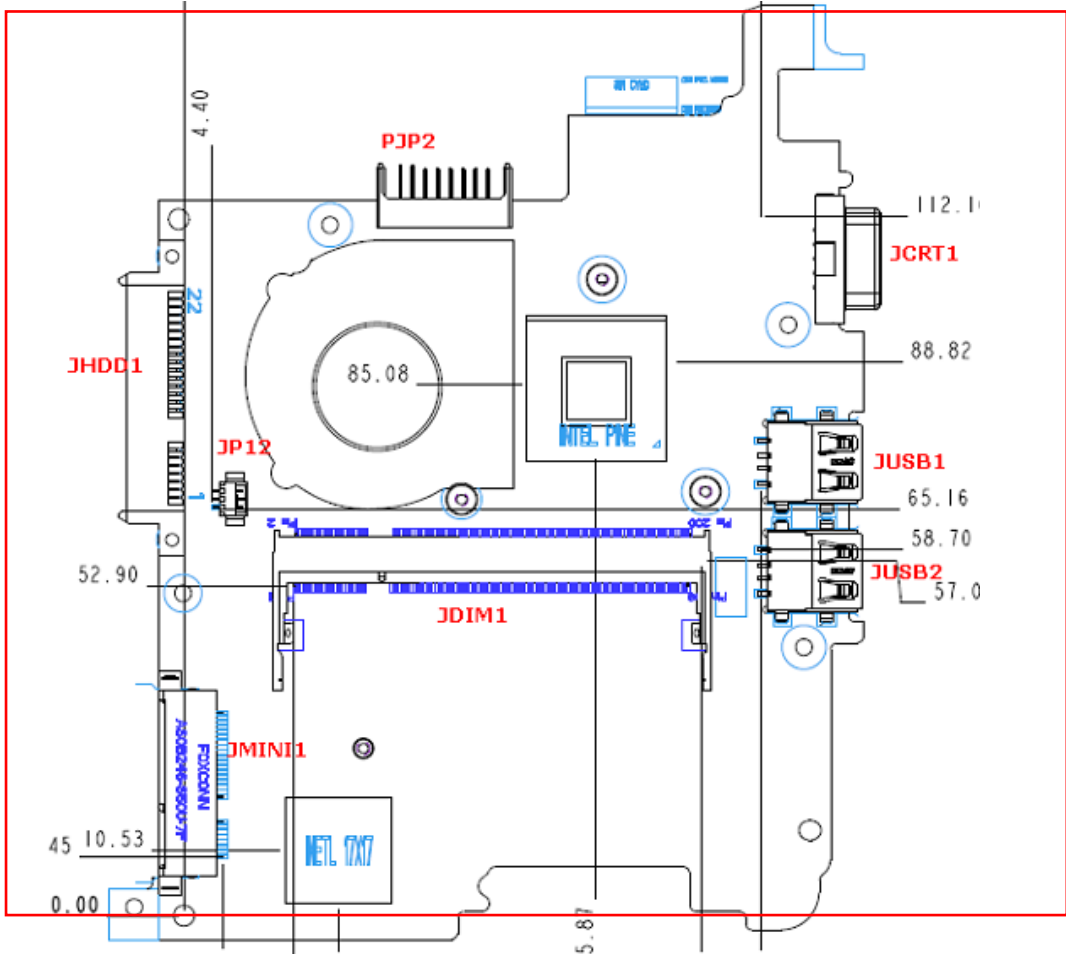

| Item  | Description       |
|-------|-------------------|
| PJP2  | Battery Connector |
| JCRT1 | CRT Connector     |
| JUSB1 | USB Connector     |
| JUSB2 | USB Connector     |
| JHDD1 | HDD Connector     |
| JDIM1 | WWAN Connector    |
| JP12  | FAN Connector     |
| JDIM1 | RAM Connector     |

# Button Board

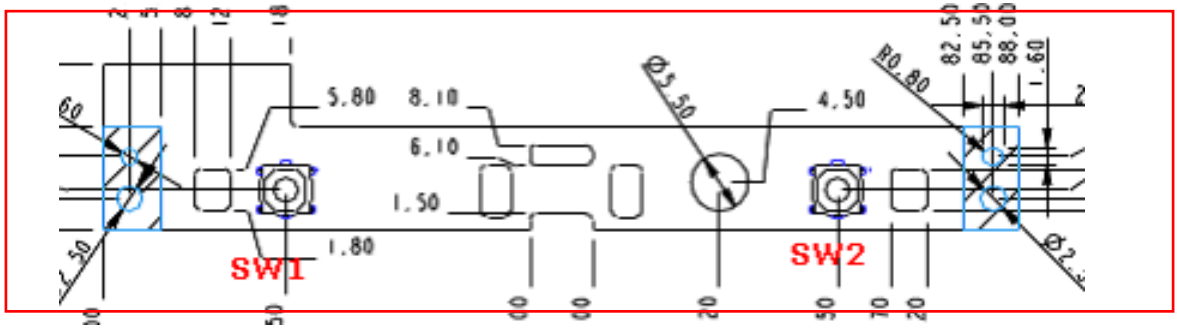

| Item | Description      |
|------|------------------|
| SW1  | T/P Left Button  |
| SW2  | T/P Right Button |

# LED Board

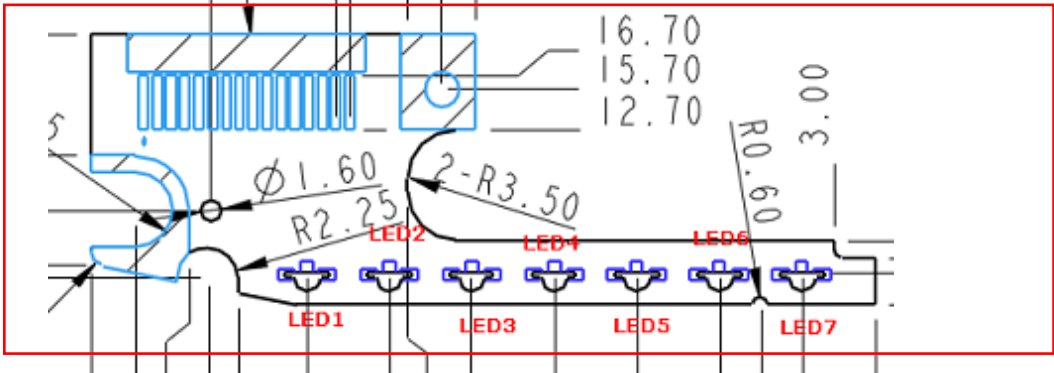

| Item | Description       |
|------|-------------------|
| LED1 | Power/Suspend LED |
| LED2 | Battery LED       |
| LED3 | Media LED         |
| LED4 | Num LED           |
| LED5 | Cap LED           |
| LED6 | WWAN/WLAN LED     |
| LED7 | BT LED            |

# I/O Board Top View

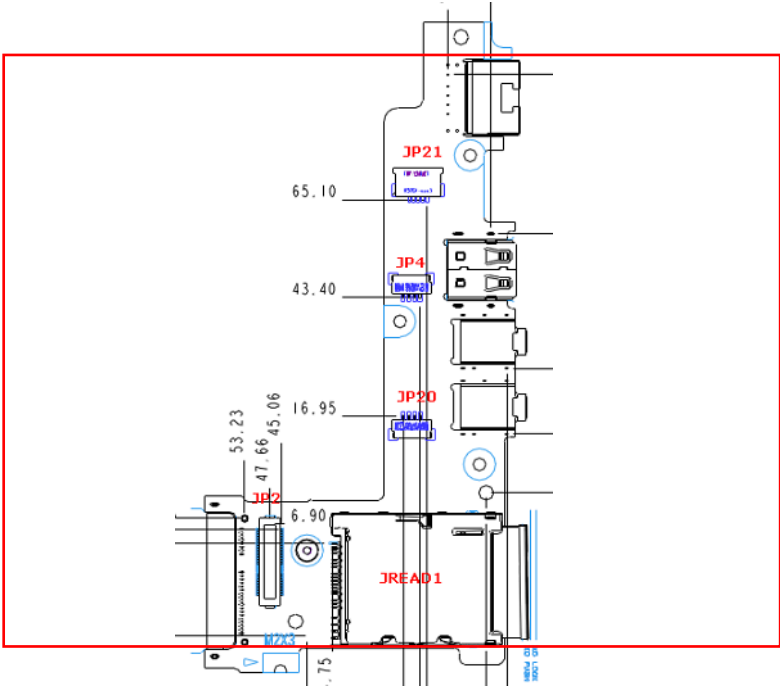

| Item   | Description          |
|--------|----------------------|
| JP21   | Function/B Connector |
| JP4    | Internal MIC         |
| JP20   | Speaker CONN         |
| JREAD1 | Card Reader Socket   |
| JP2    | Bridge/B Connector   |

# I/O Board Bottom View

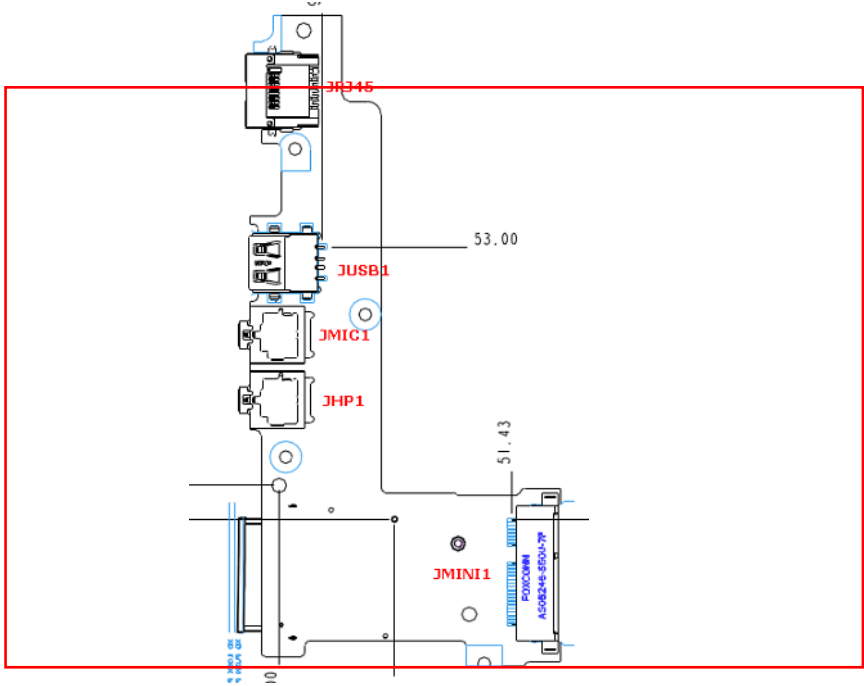

| Item   | Description     |
|--------|-----------------|
| JRJ45  | RJ45 Connector  |
| JUSB1  | USB Connector   |
| JMIC1  | MIC-In Jack     |
| JHP1   | Head-Phone Jack |
| JMINI1 | WLAN Connector  |

---

# Clearing Password Check and BIOS Recovery

This section provide you the standard operating procedures of clearing password and BIOS recovery for NAV50. NAV50 provides one Hardware Open Gap on main board for clearing password check, and one Hotkey for enabling BIOS Recovery.

## Clearing Password Check

### Hardware Open Gap Description

| Item  | Description       | Location                 |
|-------|-------------------|--------------------------|
| R1184 | Clear CMOS Jumper | Located near DIMM Module |



### Steps for Clearing BIOS Password Check

If users set BIOS Password (Supervisor Password and/or User Password) for a security reason, BIOS will ask the password during systems POST or when systems enter to BIOS Setup menu. However, once it is necessary to bypass the password check, users need to short the HW Gap to clear the password by the following steps:

- Power Off the system, and remove HDD, AC and Battery from the machine.
- Open the back cover of the machine, and locate the HW Gap on M/B as shown above.
- Use an electric conductivity tool to short the two points of the HW Gap.
- Plug in AC power, keep the short condition on the HW Gap, and press Power Button to power on the system till BIOS POST finish. Then remove the tool from the HW Gap.
- Restart system. Press F2 key to enter BIOS Setup menu.
- If there is no Password request, BIOS Password is cleared. Otherwise, please follow the steps and try again.

**NOTE:** The steps are only for clearing BIOS Password (Supervisor Password and User Password).

---

# BIOS Recovery by Crisis Disk

## BIOS Recovery Boot Block:

BIOS Recovery Boot Block is a special block of BIOS. It is used to boot up the system with minimum BIOS initialization. Users can enable this feature to restore the BIOS firmware to a successful one once the previous BIOS flashing process failed.

## BIOS Recovery Hotkey:

The system provides a function hotkey: **Fn+Esc**, for enable BIOS Recovery process when system is powered on during BIOS POST. To use this function, it is strongly recommended to have the AC adapter and Battery present. If this function is enabled, the system will force the BIOS to enter a special BIOS block, called Boot Block.

## Steps for BIOS Recovery by USB Flash Crisis Disk:

Before doing this, a Crisis Diskette should be prepared ready in hand. The Crisis Diskette could be made by executing the Crisis Disk program in another system with Windows XP OS.

Follow the steps below:

1. Plug in the USB disk.
2. Launch the **wincris.exe** program to create a USB Crisis Disk. Click **Start** to initiate the process.
3. Select the **Quick Format** option to format the disk and click **Start**. Follow the instructions on the screen to create the disk.
4. Copy the **KAV60.fd** BIOS file into USB flash disk root directory.

**NOTE:** Do not place any other \*.fd file in the USB flash disk root directory.

To use the Crisis USB key, do the following:

1. Plug USB storage into USB port.
2. Press **Fn + ESC** button then plug in AC power.  
The Power button flashes orange once.
3. Press **Power** button to initiate system CRISIS mode.  
When CRISIS is complete, the system auto restarts with a workable BIOS.
4. Update the latest version BIOS for this machine by regular BIOS flashing process.



## FRU (Field Replaceable Unit) List

---

This chapter gives you the FRU (Field Replaceable Unit) listing in global configurations of NAV50. Refer to this chapter whenever ordering for parts to repair or for RMA (Return Merchandise Authorization).

Please note that WHEN ORDERING FRU PARTS, you should check the most up-to-date information available on your regional web or channel. For whatever reasons a part number change is made, it will not be noted on the printed Service Guide. For ACER AUTHORIZED SERVICE PROVIDERS, your Acer office may have a DIFFERENT part number code from those given in the FRU list of this printed Service Guide. You MUST use the local FRU list provided by your regional Acer office to order FRU parts for repair and service of customer machines.

NOTE: To scrap or to return the defective parts, you should follow the local government ordinance or regulations on how to dispose it properly, or follow the rules set by your regional Acer office on how to return it.

# NAV50 Exploded Diagrams

## Main Assembly

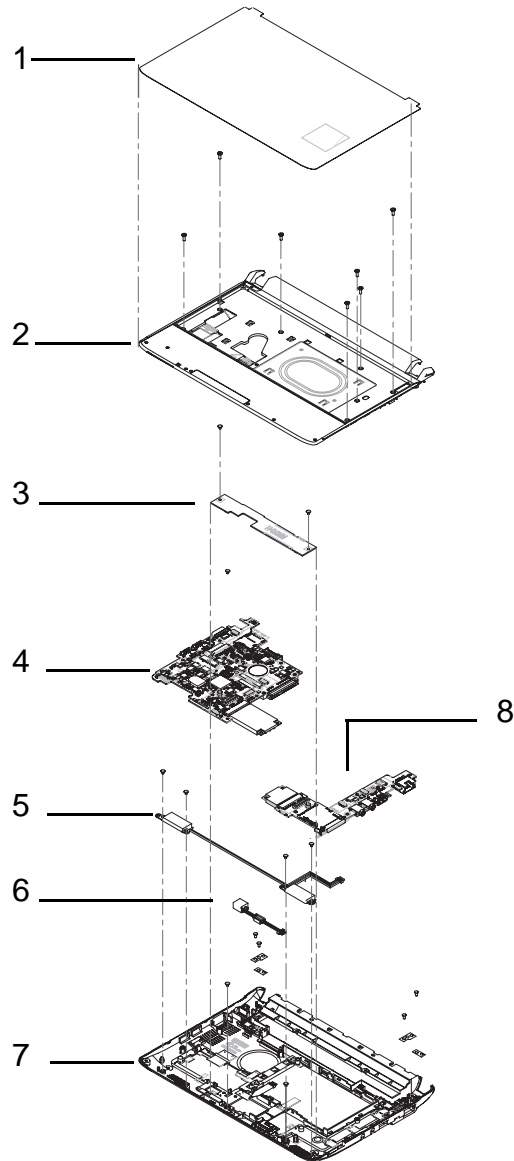

| Item | Description    | Part Number  |
|------|----------------|--------------|
| 1    | LCD Assembly   | 6M.SAL02.001 |
| 2    | Upper Cover    | 60.SAL02.001 |
| 3    | Bridge Board   | 55.SAS02.002 |
| 4    | Mainboard      | MB.SAL02.001 |
| 5    | Speaker Module | 23.SAT02.001 |
| 6    | DC-in Port     | 50.SAS02.002 |
| 7    | Lower Cover    | 60.SAM02.001 |
| 8    | I/O Board      | 55.SAS02.003 |

# Rear Assembly

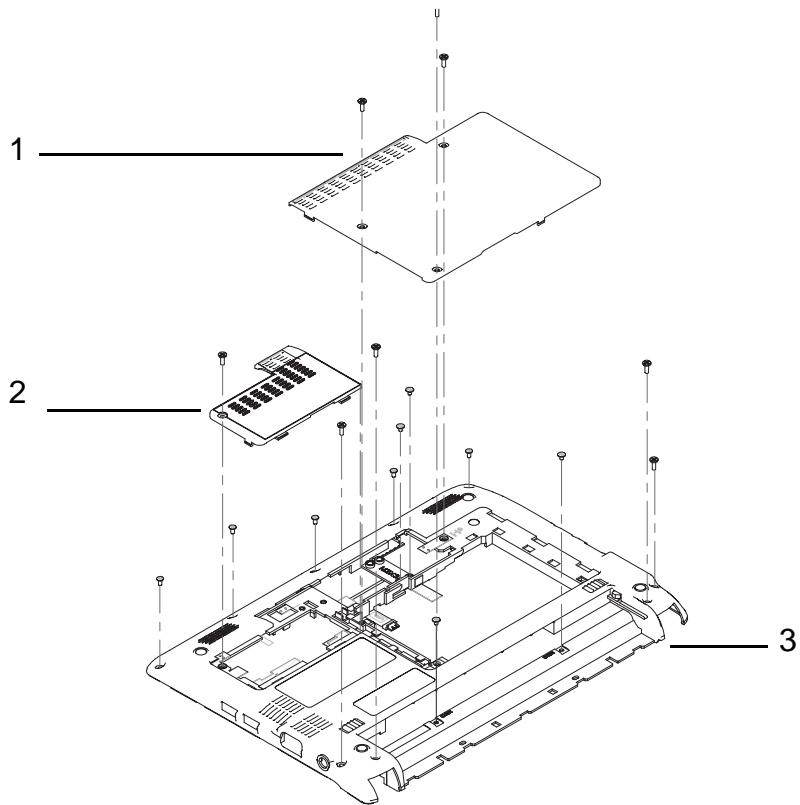

| Item | Description | Part Number  |
|------|-------------|--------------|
| 1    | HDD Door    | 42.SAL02.001 |
| 2    | DIMM Door   | 42.SAL02.002 |
| 3    | Lower Cover | 60.SAM02.001 |

# Upper Cover Assembly

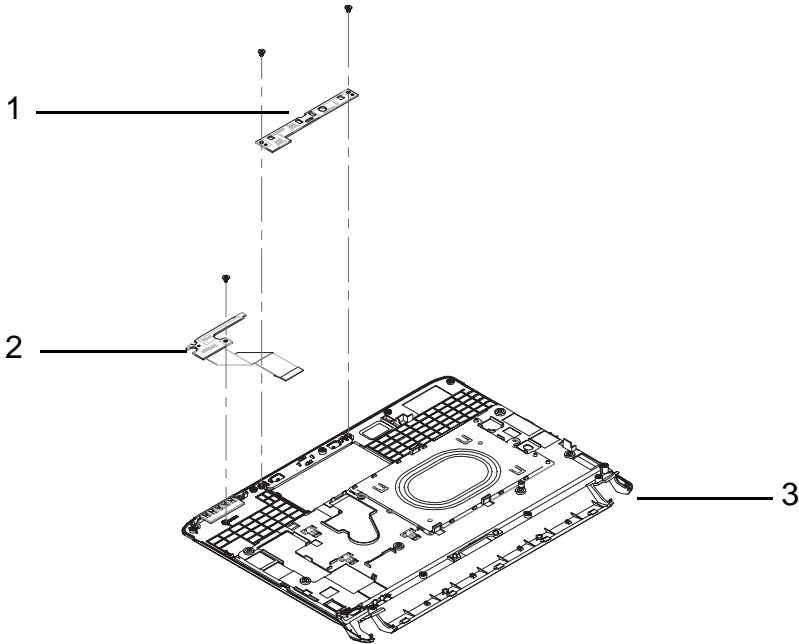

| Item | Description    | Part Number  |
|------|----------------|--------------|
| 1    | TouchPad Board |              |
| 2    | LED Board      | 55.SAS02.004 |
| 3    | Upper Cover    | 60.SAL02.001 |

# NAV50 FRU List

| CATEGORY  | Acer Description   | AcerPN       |
|---|--|--------------|
| <b>BOARD</b>  |  |              |
|    | BLUE TOOTH 2.1   | BH.21100.004 |
|   | CARD READER BOARD  | 55.SAS02.001 |
|    | BRIDGE BOARD   | 55.SAS02.002 |
|   | BUTTON BOARD   | 55.SAS02.003 |
|    | LED BOARD  | 55.SAS02.004 |
|    | FOXCONN WIRELESS LAN Atheros HB93 1X2 BGN (HM)                               | NI.23600.046 |
|   | FOXCONN WIRELESS LAN Atheros HB95 1X1 BG (HM)                                | NI.23600.047 |
|   | FOXCONN WIRELESS LAN BROADCOM 4312H BG (HM)                                  | NI.23600.053 |
|   | HUAWEI EM770W  | LC.21300.008 |
|   | 3G UNDP-1  | LC.21300.005 |
|   | ERICSSON F3307-850MHZ  | LC.21300.038 |
|   | FOXCONN BROADCOM BCM970010 MEDIA PROCESSOR MINI-CARD LINK W/ H.264/VC1/MPEG2 | LA.20500.003 |
|   | FOXCONN QUARTICS QV1721 MEDIA CO-PROCESSOR MINI-CARD TTH130.00 W             | LA.23700.001 |
| <b>CABLE</b>  |  |              |
|  | BLUE TOOTH CABLE   | 50.SAS02.001 |
|  | DC-IN CABLE  | 50.SAS02.002 |
|   | AC CLIP US   | 27.WH202.001 |
|   | AC CLIP EU   | 27.WH202.002 |
|   | AC CLIP AUSTRALIA  | 27.WH202.003 |
|   | AC CLIP UK   | 27.WH202.004 |
|   | AC CLIP ARGENTINA  | 27.WH202.005 |
|   | AC CLIP CHINA  | 27.WH202.006 |
|   | AC CLIP BRAZIL   | 27.WH202.007 |
|   | AC CLIP S-AFRICA   | 27.WH202.008 |
|   | AC CLIP KOREA  | 27.WH202.009 |
| <b>CASE/COVER/BRACKET ASSEMBLY</b>  |  |              |

| CATEGORY  | Acer Description  | AcerPN       |
|---|---|--------------|
|    | UPPER CASE ASSY FOR W/BT, INCL.TP/TP MYLAR - BLUE                                   | 60.SAL02.001 |
|   | UPPER CASE ASSY FOR W/O BT, INCL.TP/TP MYLAR - BLUE                                 | 60.SAL02.002 |
|   | UPPER CASE ASSY FOR W/BT, INCL.TP/TP MYLAR - SILVER                                 | 60.SAS02.001 |
|   | UPPER CASE ASSY FOR W/O BT, INCL.TP/TP MYLAR - SILVER                               | 60.SAS02.002 |
|   | UPPER CASE ASSY FOR W/BT, INCL.TP/TP MYLAR - RED                                    | 60.SAQ02.001 |
|   | UPPER CASE ASSY FOR W/O BT, INCL.TP/TP MYLAR - RED                                  | 60.SAQ02.002 |
|   | UPPER CASE ASSY FOR W/BT, INCL.TP/TP MYLAR - PINK                                   | 60.SAS02.003 |
|   | UPPER CASE ASSY FOR W/O BT, INCL. TP/TP MYLAR - PINK                                | 60.SAS02.004 |
|    | LOWER CASE ASSY FOR W/3G-BLACK  | 60.SAM02.001 |
|   | LOWER CASE ASSY FOR W/O 3G-BLACK  | 60.SAL02.003 |
|   | LOWER CASE ASSY FOR W/3G-WHITE  | 60.SAT02.001 |
|   | LOWER CASE ASSY FOR W/O 3G-WHITE  | 60.SAS02.005 |
|   | HDD DOOR-BLACK  | 42.SAL02.001 |
|   | HDD DOOR-WHITE  | 42.SAS02.001 |
|  | RAM DOOR-BLACK  | 42.SAL02.002 |
|   | RAM DOOR-WHITE  | 42.SAS02.002 |
|   | HDD HOUSING   | 33.SAS02.001 |
| <b>KEYBOARD</b>   |   |              |
|  | Keyboard ACER NT0T JV01_PT Internal 10 Standard 84KS Black US International Texture | KB.I100A.026 |
|   | Keyboard ACER NT0T JV01_PT Internal 10 Standard 84KS Black Greek Texture            | KB.I100A.011 |
|   | Keyboard ACER NT0T JV01_PT Internal 10 Standard 84KS Black Arabic Texture           | KB.I100A.002 |
|   | Keyboard ACER NT0T JV01_PT Internal 10 Standard 84KS Black Chinese Texture          | KB.I100A.006 |
|   | Keyboard ACER NT0T JV01_PT Internal 10 Standard 84KS Black Russian Texture          | KB.I100A.018 |

| CATEGORY | Acer Description   | AcerPN       |
|----------|--|--------------|
|          | Keyboard ACER NT0T JV01_PT Internal 10 Standard 84KS<br>Black US International w/ Hebrew Texture | KB.I100A.027 |
|          | Keyboard ACER NT0T JV01_PT Internal 10 Standard 84KS<br>Black Thailand Texture                   | KB.I100A.023 |
|          | Keyboard ACER NT0T JV01_PT Internal 10 Standard 85KS<br>Black UK Texture                         | KB.I100A.025 |
|          | Keyboard ACER NT0T JV01_PT Internal 10 Standard 85KS<br>Black German Texture                     | KB.I100A.010 |
|          | Keyboard ACER NT0T JV01_PT Internal 10 Standard 85KS<br>Black Swiss/G Texture                    | KB.I100A.022 |
|          | Keyboard ACER NT0T JV01_PT Internal 10 Standard 85KS<br>Black Belgium Texture                    | KB.I100A.003 |
|          | Keyboard ACER NT0T JV01_PT Internal 10 Standard 85KS<br>Black Danish Texture                     | KB.I100A.007 |
|          | Keyboard ACER NT0T JV01_PT Internal 10 Standard 85KS<br>Black Italian Texture                    | KB.I100A.013 |
|          | Keyboard ACER NT0T JV01_PT Internal 10 Standard 85KS<br>Black French Texture                     | KB.I100A.009 |
|          | Keyboard ACER NT0T JV01_PT Internal 10 Standard 85KS<br>Black Hungarian Texture                  | KB.I100A.012 |
|          | Keyboard ACER NT0T JV01_PT Internal 10 Standard 85KS<br>Black Norwegian Texture                  | KB.I100A.016 |
|          | Keyboard ACER NT0T JV01_PT Internal 10 Standard 85KS<br>Black Portuguese Texture                 | KB.I100A.017 |
|          | Keyboard ACER NT0T JV01_PT Internal 10 Standard 85KS<br>Black Spanish Texture                    | KB.I100A.020 |
|          | Keyboard ACER NT0T JV01_PT Internal 10 Standard 85KS<br>Black US w/ Canadian French Texture      | KB.I100A.028 |
|          | Keyboard ACER NT0T JV01_PT Internal 10 Standard 85KS<br>Black Turkish Texture                    | KB.I100A.024 |
|          | Keyboard ACER NT0T JV01_PT Internal 10 Standard 85KS<br>Black Sweden Texture                     | KB.I100A.021 |
|          | Keyboard ACER NT0T JV01_PT Internal 10 Standard 85KS<br>Black FR/Arabic Texture                  | KB.I100A.008 |
|          | Keyboard ACER NT0T JV01_PT Internal 10 Standard 85KS<br>Black Nordic Texture                     | KB.I100A.015 |
|          | Keyboard ACER NT0T JV01_PT Internal 10 Standard 85KS<br>Black SLO/CRO Texture                    | KB.I100A.019 |
|          | Keyboard ACER NT0T JV01_PT Internal 10 Standard 85KS<br>Black CZ/SK Texture                      | KB.I100A.005 |
|          | Keyboard ACER NT0T JV01_PT Internal 10 Standard 85KS<br>Black Brazilian Portuguese Texture       | KB.I100A.004 |
|          | Keyboard ACER NT0T JV01_PT Internal 10 Standard 88KS<br>Black Japanese Texture                   | KB.I100A.014 |
|          | Keyboard ACER NT0T White JV01_PT Internal 10 Standard<br>84KS White US International Texture     | KB.I100A.055 |
|          | Keyboard ACER NT0T White JV01_PT Internal 10 Standard<br>84KS White Greek Texture                | KB.I100A.039 |
|          | Keyboard ACER NT0T White JV01_PT Internal 10 Standard<br>84KS White Arabic Texture               | KB.I100A.030 |

| CATEGORY | Acer Description  | AcerPN       |
|----------|---|--------------|
|          | Keyboard ACER NT0T White JV01_PT Internal 10 Standard 84KS White Chinese Texture                    | KB.I100A.034 |
|          | Keyboard ACER NT0T White JV01_PT Internal 10 Standard 84KS White Russian Texture                    | KB.I100A.047 |
|          | Keyboard ACER NT0T White JV01_PT Internal 10 Standard 84KS White US International w/ Hebrew Texture | KB.I100A.056 |
|          | Keyboard ACER NT0T White JV01_PT Internal 10 Standard 84KS White Thailand Texture                   | KB.I100A.052 |
|          | Keyboard ACER NT0T White JV01_PT Internal 10 Standard 85KS White UK Texture                         | KB.I100A.054 |
|          | Keyboard ACER NT0T White JV01_PT Internal 10 Standard 85KS White German Texture                     | KB.I100A.038 |
|          | Keyboard ACER NT0T White JV01_PT Internal 10 Standard 85KS White Swiss/G Texture                    | KB.I100A.051 |
|          | Keyboard ACER NT0T White JV01_PT Internal 10 Standard 85KS White Belgium Texture                    | KB.I100A.031 |
|          | Keyboard ACER NT0T White JV01_PT Internal 10 Standard 85KS White Danish Texture                     | KB.I100A.035 |
|          | Keyboard ACER NT0T White JV01_PT Internal 10 Standard 85KS White Italian Texture                    | KB.I100A.041 |
|          | Keyboard ACER NT0T White JV01_PT Internal 10 Standard 85KS White French Texture                     | KB.I100A.037 |
|          | Keyboard ACER NT0T White JV01_PT Internal 10 Standard 85KS White Hungarian Texture                  | KB.I100A.040 |
|          | Keyboard ACER NT0T White JV01_PT Internal 10 Standard 85KS White Norwegian Texture                  | KB.I100A.045 |
|          | Keyboard ACER NT0T White JV01_PT Internal 10 Standard 85KS White Portuguese Texture                 | KB.I100A.046 |
|          | Keyboard ACER NT0T White JV01_PT Internal 10 Standard 85KS White Spanish Texture                    | KB.I100A.049 |
|          | Keyboard ACER NT0T White JV01_PT Internal 10 Standard 85KS White US w/ Canadian French Texture      | KB.I100A.057 |
|          | Keyboard ACER NT0T White JV01_PT Internal 10 Standard 85KS White Turkish Texture                    | KB.I100A.053 |
|          | Keyboard ACER NT0T White JV01_PT Internal 10 Standard 85KS White Sweden Texture                     | KB.I100A.050 |
|          | Keyboard ACER NT0T White JV01_PT Internal 10 Standard 85KS White FR/Arabic Texture                  | KB.I100A.036 |
|          | Keyboard ACER NT0T White JV01_PT Internal 10 Standard 85KS White Nordic Texture                     | KB.I100A.044 |
|          | Keyboard ACER NT0T White JV01_PT Internal 10 Standard 85KS White SLO/CRO Texture                    | KB.I100A.048 |
|          | Keyboard ACER NT0T White JV01_PT Internal 10 Standard 85KS White CZ/SK Texture                      | KB.I100A.033 |
|          | Keyboard ACER NT0T White JV01_PT Internal 10 Standard 85KS White Brazilian Portuguese Texture       | KB.I100A.032 |
|          | Keyboard ACER NT0T White JV01_PT Internal 10 Standard 88KS White Japanese Texture                   | KB.I100A.042 |



| CATEGORY  | Acer Description  | AcerPN       |
|---|---|--------------|
| <b>LCD</b>  |   |              |
|  | ASSY LED MODULE 10.1" WSVGA None Glare W/ ANTENNA, CCD - BLUE       | 6M.SAL02.001 |
|   | ASSY LED MODULE 10.1" WSVGA Glare W/ANTENNA, CCD - BLUE             | 6M.SAL02.002 |
|   | ASSY LED MODULE 10.1" WXGA Glare W/ANTENNA, CCD - BLUE              | 6M.SAL02.003 |
|   | ASSY LED MODULE 10.1" WSVGA None Glare W/ ANTENNA, CCD - SILVER     | 6M.SAS02.001 |
|   | ASSY LED MODULE 10.1" WSVGA Glare W/ANTENNA, CCD - SILVER           | 6M.SAS02.003 |
|   | ASSY LED MODULE 10.1" WXGA Glare W/ANTENNA, CCD - SILVER            | 6M.SAS02.005 |
|   | ASSY LED MODULE 10.1" WSVGA None Glare W/ ANTENNA, CCD - RED        | 6M.SAQ02.001 |
|   | ASSY LED MODULE 10.1" WSVGA Glare W/ANTENNA, CCD - RED              | 6M.SAQ02.002 |
|   | ASSY LED MODULE 10.1" WXGA Glare W/ANTENNA, CCD - RED               | 6M.SAQ02.003 |
|   | ASSY LED MODULE 10.1" WSVGA None Glare W/ ANTENNA, CCD - PINK       | 6M.SAS02.002 |
|   | ASSY LED MODULE 10.1" WSVGA Glare W/ANTENNA, CCD - PINK             | 6M.SAS02.004 |
|   | ASSY LED MODULE 10.1" WXGA Glare W/ANTENNA, CCD - PINK              | 6M.SAS02.006 |
|   | ASSY LED MODULE 10.1" WSVGA None Glare W/ ANTENNA, CCD, 3G - BLUE   | 6M.SAM02.001 |
|   | ASSY LED MODULE 10.1" WSVGA Glare W/ANTENNA, CCD, 3G - BLUE         | 6M.SAM02.002 |
|   | ASSY LED MODULE 10.1" WXGA Glare W/ANTENNA, CCD, 3G - BLUE          | 6M.SAM02.003 |
|   | ASSY LED MODULE 10.1" WSVGA None Glare W/ ANTENNA, CCD, 3G - SILVER | 6M.SAT02.001 |
|   | ASSY LED MODULE 10.1" WSVGA Glare W/ANTENNA, CCD, 3G - SILVER       | 6M.SAT02.002 |
|   | ASSY LED MODULE 10.1" WXGA Glare W/ANTENNA, CCD, 3G - SILVER        | 6M.SAT02.003 |
|   | ASSY LED MODULE 10.1" WSVGA None Glare W/ ANTENNA, CCD, 3G - RED    | 6M.SAR02.001 |
|   | ASSY LED MODULE 10.1" WSVGA Glare W/ANTENNA, CCD, 3G - RED          | 6M.SAR02.003 |
| ASSY LED MODULE 10.1" WXGA Glare W/ANTENNA, CCD, 3G - RED                         | 6M.SAR02.005  |              |
|   | LCD COVER IMR-PINK  | 60.SAS02.007 |
|   | LCD COVER IMR-RED   | 60.SAQ02.003 |
|   | LCD COVER IMR-BLUE  | 60.SAL02.004 |
|   | LCD COVER IMR-SILVER  | 60.SAS02.006 |

| CATEGORY  | Acer Description                           | AcerPN       |
|---|--|--------------|
|    | ANTENNA WLAN-MAIN                          | 50.SAS02.003 |
|    | ANTENNA WLAN-AUX                           | 50.SAS02.004 |
|    | LCD CABLE                                  | 50.SAS02.005 |
|    | LCD BEZEL-BLACK                            | 60.SAL02.005 |
|   | LCD BEZEL-WHITE                            | 60.SAS02.008 |
|   | LCD BRACKET R&L                            | 33.SAS02.002 |
|    | CAMERA 0.3M                                | 57.SAS02.001 |
| <b>MAINBOARD</b>  |  |              |
|   | MAINBOARD AO532H INTEL LF N450/NM10/NON-3G | MB.SAL02.001 |
|   | MAINBOARD AO532H INTEL LF N450/NM10/3G     | MB.SAM02.001 |
| <b>HEATSINK</b>   |  |              |
|  | THERMAL MODULE                             | 60.SAS02.009 |
| <b>SPEAKER</b>  |  |              |
|  | MIC SET FOR W/3G                           | 23.SAT02.001 |
|   | MIC SET FOR W/O 3G                         | 23.SAS02.001 |
|  | SPEAKER R&L                                | 23.SAS02.002 |
| <b>MISCELLANEOUS</b>  |  |              |
|   | CU FOIL FOR MEDIA PROCESSOR                | 47.SAS02.001 |
|   | ANTENNA GASKET-L                           | 47.SAS02.002 |
|   | ANTENNA GASKET-R                           | 47.SAS02.003 |
|   | LCD SCREW MYLAR-BLACK                      | 47.SAL02.001 |
|   | LCD SCREW MYLAR-WHITE                      | 47.SAS02.004 |

---

## Screw List

| CATEGORY     | Acer Description                 | AcerPN       |
|--------------|----------------------------------|--------------|
| <b>SCREW</b> |                                  |              |
|              | SCREW 2D 3L K 4.5D ZK NL         | 86.SAS02.001 |
|              | SCREW 2.0D 4.0L K 3.6D ZK NL CR3 | 86.SAS02.002 |
|              | SCREW 2D 4.0L K 4.0D NI NL 0.3T  | 86.SAS02.003 |
|              | SCREW 2D 6L K 4.6D ZK NL CR3     | 86.SAS02.004 |
|              | SCREW 2.0D 6.0L K 4.3D NI NL     | 86.SAS02.005 |
|              | SCREW 3.0D 3.0L K 4.9D NI        | 86.SAS02.006 |

# Model Definition and Configuration

## NAV50

| RO   | Country      | Acer Part No | Description   | CPU      |
|------|--------------|--------------|---|----------|
| AAP  | Vietnam      | LU.SAL0C.002 | AO532h-2Cb LINPUSSVN1 UMACbk 1*1G/160/BT/3L2.2/5R/CBSD_bg_0.3D_BAG_GEb_ES61             | ATMN450B |
| AAP  | Indonesia    | LU.SAL0D.164 | AO532h-2Db EM SNW7ST32EMSTID1 MC UMACbk 1*1G/250/BT/6L2.2/5R/CBSD_bg_0.3D_BAG_GEb_ID21  | ATMN450B |
| AAP  | Philippines  | LU.SAL0D.163 | AO532h-2Db EM SNW7ST32EMSTPH1 MC UMACbk 1*1G/250/BT/6L2.2/5R/CBSD_bgn_0.3D_BAG_GEb_ES61 | ATMN450B |
| EMEA | Denmark      | LU.SAL0D.162 | AO532h-2Db SNW7ST32STDK2 MC UMACbk 1*1G/250/BT/6L2.2/5R/CBSD_bgn_0.3D_GEb_ENS1          | ATMN450B |
| EMEA | South Africa | LU.SAL0D.073 | AO532h-2Db SNW7ST32EMSTZA2 MC UMACbk 1*1G/250/3L2.2/5R/CBSD_bg_0.3D_GEb_ES61            | ATMN450B |
| EMEA | Middle East  | LU.SAL0D.036 | AO532h-2Db SNW7ST32EMSTME9 MC UMACbk 1*1G/160/3L2.2/5R/CBSD_bg_0.3D_GEb_ES81            | ATMN450B |
| EMEA | South Africa | LU.SAL0D.114 | AO532h-2Db SNW7ST32EMSTZA2 MC UMACbk 1*1G/250/BT/6L2.2/5R/CBSD_bg_0.3D_GEb_ES61         | ATMN450B |
| EMEA | Middle East  | LU.SAL0D.116 | AO532h-2Db SNW7ST32EMSTME6 MC UMACbk 1*1G/250/BT/6L2.2/5R/CBSD_bg_0.3D_GEb_ES61         | ATMN450B |
| EMEA | South Africa | LU.SAL0D.032 | AO532h-2Db SNW7ST32EMSTZA2 MC UMACbk 1*1G/160/3L2.2/5R/CBSD_bg_0.3D_GEb_ES61            | ATMN450B |
| EMEA | Middle East  | LU.SAL0D.034 | AO532h-2Db SNW7ST32EMSTME6 MC UMACbk 1*1G/160/3L2.2/5R/CBSD_bg_0.3D_GEb_ES61            | ATMN450B |
| EMEA | Middle East  | LU.SAL0D.068 | AO532h-2Db SNW7ST32EMSTME2 MC UMACbk 1*1G/250/3L2.2/5R/CBSD_bg_0.3D_GEb_AR11            | ATMN450B |
| EMEA | Middle East  | LU.SAL0D.069 | AO532h-2Db SNW7ST32EMSTME2 MC UMACbk 1*1G/250/3L2.2/5R/CBSD_bg_0.3D_GEb_AR21            | ATMN450B |
| EMEA | Middle East  | LU.SAL0D.079 | AO532h-2Db SNW7ST32EMSTME2 MC UMACbk 1*1G/250/3L2.2/5R/CBSD_bg_0.3D_GEb_ES61            | ATMN450B |
| EMEA | Middle East  | LU.SAL0D.110 | AO532h-2Db SNW7ST32EMSTME2 MC UMACbk 1*1G/250/BT/6L2.2/5R/CBSD_bg_0.3D_GEb_AR11         | ATMN450B |
| EMEA | Middle East  | LU.SAL0D.111 | AO532h-2Db SNW7ST32EMSTME2 MC UMACbk 1*1G/250/BT/6L2.2/5R/CBSD_bg_0.3D_GEb_AR21         | ATMN450B |
| EMEA | Middle East  | LU.SAL0D.121 | AO532h-2Db SNW7ST32EMSTME2 MC UMACbk 1*1G/250/BT/6L2.2/5R/CBSD_bg_0.3D_GEb_ES61         | ATMN450B |
| EMEA | Middle East  | LU.SAL0D.027 | AO532h-2Db SNW7ST32EMSTME2 MC UMACbk 1*1G/160/3L2.2/5R/CBSD_bg_0.3D_GEb_AR11            | ATMN450B |
| EMEA | Middle East  | LU.SAL0D.028 | AO532h-2Db SNW7ST32EMSTME2 MC UMACbk 1*1G/160/3L2.2/5R/CBSD_bg_0.3D_GEb_AR21            | ATMN450B |
| EMEA | Middle East  | LU.SAL0D.037 | AO532h-2Db SNW7ST32EMSTME2 MC UMACbk 1*1G/160/3L2.2/5R/CBSD_bg_0.3D_GEb_ES61            | ATMN450B |
| EMEA | Middle East  | LU.SAL0D.071 | AO532h-2Db SNW7ST32EMSTME3 MC UMACbk 1*1G/250/3L2.2/5R/CBSD_bg_0.3D_GEb_ES81            | ATMN450B |
| EMEA | South Africa | LU.SAL0D.072 | AO532h-2Db SNW7ST32EMSTZA1 MC UMACbk 1*1G/250/3L2.2/5R/CBSD_bg_0.3D_GEb_ES81            | ATMN450B |

| RO   | Country              | Acer Part No | Description  | CPU      |
|------|----------------------|--------------|--|----------|
| EMEA | Middle East          | LU.SAL0D.112 | AO532h-2Db SNW7ST32EMSTME3 MC UMACbk 1*1G/250/BT/6L2.2/5R/CBSD_bg_0.3D_GEb_ES81    | ATMN450B |
| EMEA | South Africa         | LU.SAL0D.113 | AO532h-2Db SNW7ST32EMSTZA1 MC UMACbk 1*1G/250/BT/6L2.2/5R/CBSD_bg_0.3D_GEb_ES81    | ATMN450B |
| EMEA | Middle East          | LU.SAL0D.030 | AO532h-2Db SNW7ST32EMSTME3 MC UMACbk 1*1G/160/3L2.2/5R/CBSD_bg_0.3D_GEb_ES81       | ATMN450B |
| EMEA | South Africa         | LU.SAL0D.031 | AO532h-2Db SNW7ST32EMSTZA1 MC UMACbk 1*1G/160/3L2.2/5R/CBSD_bg_0.3D_GEb_ES81       | ATMN450B |
| EMEA | Serbia/<br>Macedonia | LU.SAL0D.077 | AO532h-2Db SNW7ST32EMSTCS1 MC UMACbk 1*1G/250/3L2.2/5R/CBSD_bg_0.3D_GEb_SL11       | ATMN450B |
| EMEA | Serbia/<br>Macedonia | LU.SAL0D.118 | AO532h-2Db SNW7ST32EMSTCS1 MC UMACbk 1*1G/250/BT/6L2.2/5R/CBSD_bg_0.3D_GEb_SL11    | ATMN450B |
| EMEA | Serbia/<br>Macedonia | LU.SAL0D.035 | AO532h-2Db SNW7ST32EMSTCS1 MC UMACbk 1*1G/160/3L2.2/5R/CBSD_bg_0.3D_GEb_SL11       | ATMN450B |
| EMEA | Middle East          | LU.SAL0D.076 | AO532h-2Db SNW7ST32EMSTME4 MC UMACbk 1*1G/250/3L2.2/5R/CBSD_bg_0.3D_GEb_ES61       | ATMN450B |
| EMEA | Middle East          | LU.SAL0D.117 | AO532h-2Db SNW7ST32EMSTME4 MC UMACbk 1*1G/250/BT/6L2.2/5R/CBSD_bg_0.3D_GEb_ES61    | ATMN450B |
| EMEA | Middle East          | LU.SAL0D.038 | AO532h-2Db SNW7ST32EMSTME4 MC UMACbk 1*1G/160/3L2.2/5R/CBSD_bg_0.3D_GEb_ES61       | ATMN450B |
| EMEA | Turkey               | LU.SAL0D.070 | AO532h-2Db SNW7ST32EMSTTR1 MC UMACbk 1*1G/250/3L2.2/5R/CBSD_bg_0.3D_GEb_TR31       | ATMN450B |
| EMEA | Turkey               | LU.SAL0D.119 | AO532h-2Db SNW7ST32EMSTTR1 MC UMACbk 1*1G/250/BT/6L2.2/5R/CBSD_bg_0.3D_GEb_TR31    | ATMN450B |
| EMEA | Turkey               | LU.SAL0D.029 | AO532h-2Db SNW7ST32EMSTTR1 MC UMACbk 1*1G/160/3L2.2/5R/CBSD_bg_0.3D_GEb_TR31       | ATMN450B |
| EMEA | Algeria              | LU.SAL0D.074 | AO532h-2Db SNW7ST32EMSTDZ1 MC UMACbk 1*1G/250/3L2.2/5R/CBSD_bg_0.3D_GEb_ES81       | ATMN450B |
| EMEA | Middle East          | LU.SAL0D.078 | AO532h-2Db SNW7ST32EMSTME9 MC UMACbk 1*1G/250/3L2.2/5R/CBSD_bg_0.3D_GEb_ES81       | ATMN450B |
| EMEA | Algeria              | LU.SAL0D.115 | AO532h-2Db SNW7ST32EMSTDZ1 MC UMACbk 1*1G/250/BT/6L2.2/5R/CBSD_bg_0.3D_GEb_ES81    | ATMN450B |
| EMEA | Middle East          | LU.SAL0D.120 | AO532h-2Db SNW7ST32EMSTME9 MC UMACbk 1*1G/250/BT/6L2.2/5R/CBSD_bg_0.3D_GEb_ES81    | ATMN450B |
| EMEA | Algeria              | LU.SAL0D.033 | AO532h-2Db SNW7ST32EMSTDZ1 MC UMACbk 1*1G/160/3L2.2/5R/CBSD_bg_0.3D_GEb_ES81       | ATMN450B |
| EMEA | Middle East          | LU.SAL0D.075 | AO532h-2Db SNW7ST32EMSTME6 MC UMACbk 1*1G/250/3L2.2/5R/CBSD_bg_0.3D_GEb_ES61       | ATMN450B |
| EMEA | UK                   | LU.SAL0D.161 | AO532h-2Db SNW7ST32STGB1 MC UMACbk 1*1G/250/BT/6L2.8/5R/CB_bgn_0.3D_GEb_EN11       | ATMN450B |
| EMEA | UK                   | LU.SAL0D.160 | AO532h-2Db SNW7ST32STGB1 MC UMACbk 1*1G/250/BT/6L2.8/5R/CB_bgn_0.3D_BAG_GEb_EN11   | ATMN450B |
| EMEA | UK                   | LU.SAL0D.159 | AO532h-2Db SNW7ST32STGB1 MC UMACbk 1*1G/250/BT/6L2.8/5R/CBSD_bgn_0.3D_BAG_GEb_EN11 | ATMN450B |
| EMEA | UK                   | LU.SAL0D.158 | AO532h-2Db SNW7ST32STGB1 MC UMACbk 1*1G/250/BT/6L2.8/5R/CBSD_bgn_0.3D_GEb_EN11     | ATMN450B |
| AAP  | India                | LU.SAL0B.106 | AO532h-2Bb AOXPHSTIN1 MC UMACbk 1*1G/160/BT/6L2.2/5R/CBSD_bg_0.3D_BAG_GEb_EN11     | ATMN450B |
| AAP  | India                | LU.SAL0C.001 | AO532h-2Cb LINPUSSIN1 UMACbk 1*1G/160/BT/6L2.2/5R/CBSD_bg_0.3D_BAG_GEb_ES61        | ATMN450B |
| AAP  | Japan                | LU.SAL0D.157 | AO532h-2Db SNW7ST32SPJP1 MC UMACbk 1*1G/250/BT/6L2.2/5R/CB_bgn_0.3D_BAG_GEb_JA11   | ATMN450B |
| AAP  | Singapore            | LU.SAL0D.156 | AO532h-2Db SNW7ST32STSG1 MC UMACbk 1*1G/250/BT/6L2.2/5R/CB_bgn_0.3D_BAG_GEb_ES61   | ATMN450B |

| RO   | Country     | Acer Part No | Description  | CPU      |
|------|-------------|--------------|--|----------|
| AAP  | Singapore   | LU.SAL0D.155 | AO532h-2Db SNW7ST32STSG1 MC UMACbk 1*1G/<br>250/BT/6L2.2/5R/CBSD_bgn_0.3D_BAG_GEb_ES61 | ATMN450B |
| EMEA | Spain       | LU.SAL0D.154 | AO532h-2Db SNW7ST32STES1 MC UMACbk 1*1G/<br>250/3L2.2/5R/CB_bg_0.3D_GEb_ES51           | ATMN450B |
| EMEA | Luxembourg  | LU.SAL0D.153 | AO532h-2Db SNW7ST32STLU3 MC UMACbk 1*1G/<br>250/BT/6L2.8/5R/CB_bgn_0.3D_GEb_IT41       | ATMN450B |
| EMEA | Holland     | LU.SAL0D.152 | AO532h-2Db SNW7ST32STNL1 MC UMACbk 1*1G/<br>250/BT/6L2.8/5R/CB_bgn_0.3D_GEb_NL11       | ATMN450B |
| EMEA | Belgium     | LU.SAL0D.151 | AO532h-2Db SNW7ST32STBE1 MC UMACbk 1*1G/<br>250/BT/6L2.8/5R/CB_bgn_0.3D_GEb_NL11       | ATMN450B |
| EMEA | Luxembourg  | LU.SAL0D.150 | AO532h-2Db SNW7ST32STLU3 MC UMACbk 1*1G/<br>160/3L2.2/5R/CBSD_bgn_0.3D_GEb_IT41        | ATMN450B |
| EMEA | Holland     | LU.SAL0D.149 | AO532h-2Db SNW7ST32STNL1 MC UMACbk 1*1G/<br>160/3L2.2/5R/CBSD_bgn_0.3D_GEb_NL11        | ATMN450B |
| EMEA | Belgium     | LU.SAL0D.148 | AO532h-2Db SNW7ST32STBE1 MC UMACbk 1*1G/<br>160/3L2.2/5R/CBSD_bgn_0.3D_GEb_NL11        | ATMN450B |
| EMEA | Poland      | LU.SAL0D.146 | AO532h-2Db SNW7ST32STPL1 MC UMACbk 1*1G/<br>250/BT/6L2.2/5R/CBSD_bg_0.3D_GEb_PL11      | ATMN450B |
| EMEA | Israel      | LU.SAL0D.145 | AO532h-2Db SNW7ST32STIL1 MC UMACbk 1*1G/<br>250/BT/6L2.2/5R/CBSD_bg_0.3D_GEb_HE11      | ATMN450B |
| EMEA | Greece      | LU.SAL0D.144 | AO532h-2Db SNW7ST32STGR1 MC UMACbk 1*1G/<br>250/BT/6L2.2/5R/CBSD_bg_0.3D_GEb_EL31      | ATMN450B |
| EMEA | Luxembourg  | LU.SAL0D.142 | AO532h-2Db SNW7ST32STLU3 MC UMACbk 1*1G/<br>250/BT/6L2.2/5R/CBSD_bg_0.3D_GEb_IT41      | ATMN450B |
| EMEA | Portugal    | LU.SAL0D.143 | AO532h-2Db SNW7ST32STPT1 MC UMACbk 1*1G/<br>250/BT/6L2.2/5R/CBSD_bg_0.3D_GEb_PT11      | ATMN450B |
| EMEA | Germany     | LU.SAL0D.141 | AO532h-2Db SNW7ST32STDE1 MC UMACbk 1*1G/<br>250/BT/6L2.2/5R/CBSD_bg_0.3D_GEb_DE13      | ATMN450B |
| EMEA | Holland     | LU.SAL0D.140 | AO532h-2Db SNW7ST32STNL1 MC UMACbk 1*1G/<br>250/BT/6L2.2/5R/CBSD_bg_0.3D_GEb_NL11      | ATMN450B |
| EMEA | Finland     | LU.SAL0D.139 | AO532h-2Db SNW7ST32STFI2 MC UMACbk 1*1G/<br>250/BT/6L2.2/5R/CBSD_bg_0.3D_GEb_FI11      | ATMN450B |
| EMEA | Austria     | LU.SAL0D.138 | AO532h-2Db SNW7ST32STAT1 MC UMACbk 1*1G/<br>250/BT/6L2.2/5R/CBSD_bg_0.3D_GEb_DE61      | ATMN450B |
| EMEA | Italy       | LU.SAL0D.137 | AO532h-2Db SNW7ST32STIT1 MC UMACbk 1*1G/<br>250/BT/6L2.2/5R/CBSD_bg_0.3D_GEb_IT11      | ATMN450B |
| EMEA | France      | LU.SAL0D.136 | AO532h-2Db SNW7ST32STFR1 MC UMACbk 1*1G/<br>250/BT/6L2.2/5R/CBSD_bg_0.3D_GEb_FR21      | ATMN450B |
| EMEA | Switzerland | LU.SAL0D.134 | AO532h-2Db SNW7ST32STCH1 MC UMACbk 1*1G/<br>250/BT/6L2.2/5R/CBSD_bg_0.3D_GEb_IT41      | ATMN450B |
| EMEA | UK          | LU.SAL0D.135 | AO532h-2Db SNW7ST32STGB1 MC UMACbk 1*1G/<br>250/BT/6L2.2/5R/CBSD_bg_0.3D_GEb_EN11      | ATMN450B |
| EMEA | Sweden      | LU.SAL0D.133 | AO532h-2Db SNW7ST32STSE1 MC UMACbk 1*1G/<br>250/BT/6L2.2/5R/CBSD_bg_0.3D_GEb_FI11      | ATMN450B |
| EMEA | Spain       | LU.SAL0D.132 | AO532h-2Db SNW7ST32STES1 MC UMACbk 1*1G/<br>250/BT/6L2.2/5R/CBSD_bg_0.3D_GEb_ES51      | ATMN450B |
| EMEA | Norway      | LU.SAL0D.131 | AO532h-2Db SNW7ST32STNO1 MC UMACbk 1*1G/<br>250/BT/6L2.2/5R/CBSD_bg_0.3D_GEb_NO11      | ATMN450B |
| EMEA | Hungary     | LU.SAL0D.130 | AO532h-2Db SNW7ST32STHU1 MC UMACbk 1*1G/<br>250/BT/6L2.2/5R/CBSD_bg_0.3D_GEb_HU11      | ATMN450B |
| EMEA | Denmark     | LU.SAL0D.129 | AO532h-2Db SNW7ST32STDK2 MC UMACbk 1*1G/<br>250/BT/6L2.2/5R/CBSD_bg_0.3D_GEb_ENS1      | ATMN450B |
| EMEA | Czech       | LU.SAL0D.128 | AO532h-2Db SNW7ST32STCZ2 MC UMACbk 1*1G/<br>250/BT/6L2.2/5R/CBSD_bg_0.3D_GEb_SK11      | ATMN450B |

| RO   | Country     | Acer Part No | Description   | CPU      |
|------|-------------|--------------|---|----------|
| EMEA | Cyprus      | LU.SAL0D.127 | AO532h-2Db SNW7ST32STCY1 MC UMACbk 1*1G/250/BT/6L2.2/5R/CBSD_bg_0.3D_GEb_ES61   | ATMN450B |
| EMEA | Latvia      | LU.SAL0D.125 | AO532h-2Db SNW7ST32STLV1 MC UMACbk 1*1G/250/BT/6L2.2/5R/CBSD_bg_0.3D_GEb_RU21   | ATMN450B |
| EMEA | Germany     | LU.SAL0D.124 | AO532h-2Db SNW7ST32STDE1 MC UMACbk 1*1G/250/BT/6L2.2/5R/CBSD_bg_0.3D_GEb_DE11   | ATMN450B |
| EMEA | Denmark     | LU.SAL0D.123 | AO532h-2Db SNW7ST32STDK1 MC UMACbk 1*1G/250/BT/6L2.2/5R/CBSD_bg_0.3D_GEb_NO11   | ATMN450B |
| EMEA | Belgium     | LU.SAL0D.122 | AO532h-2Db SNW7ST32STBE1 MC UMACbk 1*1G/250/BT/6L2.2/5R/CBSD_bg_0.3D_GEb_NL11   | ATMN450B |
| EMEA | Ukraine     | LU.SAL0D.109 | AO532h-2Db SNW7ST32RUSTUK1 MC UMACbk 1*1G/250/BT/6L2.2/5R/CBSD_bg_0.3D_GEb_RU61 | ATMN450B |
| EMEA | Russia      | LU.SAL0D.108 | AO532h-2Db SNW7ST32RUSTRU1 MC UMACbk 1*1G/250/BT/6L2.2/5R/CBSD_bg_0.3D_GEb_RU62 | ATMN450B |
| EMEA | Russia      | LU.SAL0D.107 | AO532h-2Db SNW7ST32RUSTRU1 MC UMACbk 1*1G/250/BT/6L2.2/5R/CBSD_bg_0.3D_GEb_RU61 | ATMN450B |
| EMEA | Finland     | LU.SAL0D.105 | AO532h-2Db SNW7ST32STFI2 MC UMACbk 1*1G/250/3L2.2/5R/CBSD_bg_0.3D_GEb_FI11      | ATMN450B |
| EMEA | Poland      | LU.SAL0D.104 | AO532h-2Db SNW7ST32STPL1 MC UMACbk 1*1G/250/3L2.2/5R/CBSD_bg_0.3D_GEb_PL11      | ATMN450B |
| EMEA | Israel      | LU.SAL0D.103 | AO532h-2Db SNW7ST32STIL1 MC UMACbk 1*1G/250/3L2.2/5R/CBSD_bg_0.3D_GEb_HE11      | ATMN450B |
| EMEA | Greece      | LU.SAL0D.102 | AO532h-2Db SNW7ST32STGR1 MC UMACbk 1*1G/250/3L2.2/5R/CBSD_bg_0.3D_GEb_EL31      | ATMN450B |
| EMEA | Portugal    | LU.SAL0D.101 | AO532h-2Db SNW7ST32STPT1 MC UMACbk 1*1G/250/3L2.2/5R/CBSD_bg_0.3D_GEb_PT11      | ATMN450B |
| EMEA | Luxembourg  | LU.SAL0D.099 | AO532h-2Db SNW7ST32STLU3 MC UMACbk 1*1G/250/3L2.2/5R/CBSD_bg_0.3D_GEb_IT41      | ATMN450B |
| EMEA | Germany     | LU.SAL0D.098 | AO532h-2Db SNW7ST32STDE1 MC UMACbk 1*1G/250/3L2.2/5R/CBSD_bg_0.3D_GEb_DE13      | ATMN450B |
| EMEA | Holland     | LU.SAL0D.097 | AO532h-2Db SNW7ST32STNL1 MC UMACbk 1*1G/250/3L2.2/5R/CBSD_bg_0.3D_GEb_NL11      | ATMN450B |
| EMEA | Austria     | LU.SAL0D.096 | AO532h-2Db SNW7ST32STAT1 MC UMACbk 1*1G/250/3L2.2/5R/CBSD_bg_0.3D_GEb_DE61      | ATMN450B |
| EMEA | Italy       | LU.SAL0D.095 | AO532h-2Db SNW7ST32STIT1 MC UMACbk 1*1G/250/3L2.2/5R/CBSD_bg_0.3D_GEb_IT11      | ATMN450B |
| EMEA | Latvia      | LU.SAL0D.093 | AO532h-2Db SNW7ST32STLV1 MC UMACbk 1*1G/250/3L2.2/5R/CBSD_bg_0.3D_GEb_RU21      | ATMN450B |
| EMEA | Germany     | LU.SAL0D.092 | AO532h-2Db SNW7ST32STDE1 MC UMACbk 1*1G/250/3L2.2/5R/CBSD_bg_0.3D_GEb_DE11      | ATMN450B |
| EMEA | France      | LU.SAL0D.091 | AO532h-2Db SNW7ST32STFR1 MC UMACbk 1*1G/250/3L2.2/5R/CBSD_bg_0.3D_GEb_FR21      | ATMN450B |
| EMEA | Denmark     | LU.SAL0D.090 | AO532h-2Db SNW7ST32STDK2 MC UMACbk 1*1G/250/3L2.2/5R/CBSD_bg_0.3D_GEb_ENS1      | ATMN450B |
| EMEA | Switzerland | LU.SAL0D.088 | AO532h-2Db SNW7ST32STCH1 MC UMACbk 1*1G/250/3L2.2/5R/CBSD_bg_0.3D_GEb_IT41      | ATMN450B |
| EMEA | UK          | LU.SAL0D.089 | AO532h-2Db SNW7ST32STGB1 MC UMACbk 1*1G/250/3L2.2/5R/CBSD_bg_0.3D_GEb_EN11      | ATMN450B |
| EMEA | Sweden      | LU.SAL0D.087 | AO532h-2Db SNW7ST32STSE1 MC UMACbk 1*1G/250/3L2.2/5R/CBSD_bg_0.3D_GEb_FI11      | ATMN450B |
| EMEA | Spain       | LU.SAL0D.086 | AO532h-2Db SNW7ST32STES1 MC UMACbk 1*1G/250/3L2.2/5R/CBSD_bg_0.3D_GEb_ES51      | ATMN450B |
| EMEA | Norway      | LU.SAL0D.085 | AO532h-2Db SNW7ST32STNO1 MC UMACbk 1*1G/250/3L2.2/5R/CBSD_bg_0.3D_GEb_NO11      | ATMN450B |

| RO   | Country        | Acer Part No | Description  | CPU      |
|------|----------------|--------------|--|----------|
| EMEA | Hungary        | LU.SAL0D.084 | AO532h-2Db SNW7ST32STHU1 MC UMACbk 1*1G/250/3L2.2/5R/CBSD_bg_0.3D_GEb_HU11   | ATMN450B |
| EMEA | Denmark        | LU.SAL0D.083 | AO532h-2Db SNW7ST32STDK1 MC UMACbk 1*1G/250/3L2.2/5R/CBSD_bg_0.3D_GEb_NO11   | ATMN450B |
| EMEA | Czech          | LU.SAL0D.082 | AO532h-2Db SNW7ST32STCZ2 MC UMACbk 1*1G/250/3L2.2/5R/CBSD_bg_0.3D_GEb_SK11   | ATMN450B |
| EMEA | Cyprus         | LU.SAL0D.081 | AO532h-2Db SNW7ST32STCY1 MC UMACbk 1*1G/250/3L2.2/5R/CBSD_bg_0.3D_GEb_ES61   | ATMN450B |
| EMEA | Belgium        | LU.SAL0D.080 | AO532h-2Db SNW7ST32STBE1 MC UMACbk 1*1G/250/3L2.2/5R/CBSD_bg_0.3D_GEb_NL11   | ATMN450B |
| EMEA | Ukraine        | LU.SAL0D.067 | AO532h-2Db SNW7ST32RUSTUK1 MC UMACbk 1*1G/250/3L2.2/5R/CBSD_bg_0.3D_GEb_RU61 | ATMN450B |
| EMEA | Russia         | LU.SAL0D.066 | AO532h-2Db SNW7ST32RUSTRU1 MC UMACbk 1*1G/250/3L2.2/5R/CBSD_bg_0.3D_GEb_RU62 | ATMN450B |
| EMEA | Russia         | LU.SAL0D.065 | AO532h-2Db SNW7ST32RUSTRU1 MC UMACbk 1*1G/250/3L2.2/5R/CBSD_bg_0.3D_GEb_RU61 | ATMN450B |
| EMEA | UK             | LU.SAL0B.105 | AO532h-2Bb AOXPHSTGB1 MC UMACbk 1*1G/160/6L2.2/5R/CBSD_bg_0.3D_GEb_EN12      | ATMN450B |
| EMEA | Denmark        | LU.SAL0B.104 | AO532h-2Bb AOXPHSTDK1 MC UMACbk 1*1G/160/6L2.2/5R/CBSD_bg_0.3D_GEb_NO12      | ATMN450B |
| EMEA | Poland         | LU.SAL0B.103 | AO532h-2Bb AOXPHSTPL1 MC UMACbk 1*1G/160/6L2.2/5R/CBSD_bg_0.3D_GEb_PL11      | ATMN450B |
| EMEA | Italy          | LU.SAL0B.102 | AO532h-2Bb AOXPHSTIT1 MC UMACbk 1*1G/160/6L2.2/5R/CBSD_bg_0.3D_GEb_IT12      | ATMN450B |
| EMEA | Middle East    | LU.SAL0B.101 | AO532h-2Bb EM AOXPHSTME4 MC UMACbk 1*1G/160/6L2.2/5R/CBSD_bg_0.3D_GEb_EN12   | ATMN450B |
| EMEA | Greece         | LU.SAL0B.099 | AO532h-2Bb AOXPHSTGR1 MC UMACbk 1*1G/160/6L2.2/5R/CBSD_bg_0.3D_GEb_EL32      | ATMN450B |
| EMEA | Middle East    | LU.SAL0B.098 | AO532h-2Bb EM AOXPHSTME9 MC UMACbk 1*1G/160/6L2.2/5R/CBSD_bg_0.3D_GEb_FR22   | ATMN450B |
| EMEA | Middle East    | LU.SAL0B.097 | AO532h-2Bb EM AOXPHSTME2 MC UMACbk 1*1G/160/6L2.2/5R/CBSD_bg_0.3D_GEb_AR22   | ATMN450B |
| EMEA | Eastern Europe | LU.SAL0B.096 | AO532h-2Bb AOXPHSTEU7 MC UMACbk 1*1G/160/6L2.2/5R/CBSD_bg_0.3D_GEb_ENR2      | ATMN450B |
| EMEA | Hungary        | LU.SAL0B.095 | AO532h-2Bb AOXPHSTHU1 MC UMACbk 1*1G/160/6L2.2/5R/CBSD_bg_0.3D_GEb_HU14      | ATMN450B |
| EMEA | Ukraine        | LU.SAL0B.094 | AO532h-2Bb AOXPHSTUK1 MC UMACbk 1*1G/160/6L2.2/5R/CBSD_bg_0.3D_GEb_RU11      | ATMN450B |
| EMEA | Czech          | LU.SAL0B.093 | AO532h-2Bb AOXPHSTCZ2 MC UMACbk 1*1G/160/6L2.2/5R/CBSD_bg_0.3D_GEb_SK14      | ATMN450B |
| EMEA | Russia         | LU.SAL0B.092 | AO532h-2Bb AOXPHSTRU1 MC UMACbk 1*1G/160/6L2.2/5R/CBSD_bg_0.3D_GEb_RU12      | ATMN450B |
| EMEA | Austria        | LU.SAL0B.091 | AO532h-2Bb AOXPHSTAT1 MC UMACbk 1*1G/160/6L2.2/5R/CBSD_bg_0.3D_GEb_DE11      | ATMN450B |
| EMEA | Portugal       | LU.SAL0B.090 | AO532h-2Bb AOXPHSTPT1 MC UMACbk 1*1G/160/6L2.2/5R/CBSD_bg_0.3D_GEb_PT12      | ATMN450B |
| EMEA | Eastern Europe | LU.SAL0B.089 | AO532h-2Bb AOXPHSTEU5 MC UMACbk 1*1G/160/6L2.2/5R/CBSD_bg_0.3D_GEb_PL14      | ATMN450B |
| EMEA | Eastern Europe | LU.SAL0B.088 | AO532h-2Bb AOXPHSTEU4 MC UMACbk 1*1G/160/6L2.2/5R/CBSD_bg_0.3D_GEb_FI13      | ATMN450B |
| EMEA | Denmark        | LU.SAL0B.086 | AO532h-2Bb AOXPHSTDK2 MC UMACbk 1*1G/160/6L2.2/5R/CBSD_bg_0.3D_GEb_ENS1      | ATMN450B |
| EMEA | Turkey         | LU.SAL0B.087 | AO532h-2Bb EM AOXPHSTTR1 MC UMACbk 1*1G/160/6L2.2/5R/CBSD_bg_0.3D_GEb_TR33   | ATMN450B |



| RO   | Country              | Acer Part No | Description  | CPU      |
|------|----------------------|--------------|--|----------|
| EMEA | Russia               | LU.SAL0B.085 | AO532h-2Bb AOXPHSTRU1 MC UMACbk 1*1G/160/6L2.2/5R/CBSD_bg_0.3D_GEb_RU14    | ATMN450B |
| EMEA | Poland               | LU.SAL0B.084 | AO532h-2Bb AOXPHSTPL1 MC UMACbk 1*1G/160/6L2.2/5R/CBSD_bg_0.3D_GEb_PL12    | ATMN450B |
| EMEA | Israel               | LU.SAL0B.082 | AO532h-2Bb AOXPHSTIL1 MC UMACbk 1*1G/160/6L2.2/5R/CBSD_bg_0.3D_GEb_HE13    | ATMN450B |
| EMEA | Switzerland          | LU.SAL0B.083 | AO532h-2Bb AOXPHSTCH1 MC UMACbk 1*1G/160/6L2.2/5R/CBSD_bg_0.3D_GEb_IT43    | ATMN450B |
| EMEA | Latvia               | LU.SAL0B.080 | AO532h-2Bb AOXPHSTLV1 MC UMACbk 1*1G/160/6L2.2/5R/CBSD_bg_0.3D_GEb_RU21    | ATMN450B |
| EMEA | Serbia/<br>Macedonia | LU.SAL0B.079 | AO532h-2Bb EM AOXPHSTCS1 MC UMACbk 1*1G/160/6L2.2/5R/CBSD_bg_0.3D_GEb_SL11 | ATMN450B |
| EMEA | Cyprus               | LU.SAL0B.078 | AO532h-2Bb AOXPHSTCY1 MC UMACbk 1*1G/160/6L2.2/5R/CBSD_bg_0.3D_GEb_EN11    | ATMN450B |
| EMEA | Switzerland          | LU.SAL0B.077 | AO532h-2Bb AOXPHSTCH1 MC UMACbk 1*1G/160/6L2.2/5R/CBSD_bg_0.3D_GEb_IT42    | ATMN450B |
| EMEA | Germany              | LU.SAL0B.076 | AO532h-2Bb AOXPHSTDE1 MC UMACbk 1*1G/160/6L2.2/5R/CBSD_bg_0.3D_GEb_DE12    | ATMN450B |
| EMEA | Spain                | LU.SAL0B.075 | AO532h-2Bb AOXPHSTES1 MC UMACbk 1*1G/160/6L2.2/5R/CBSD_bg_0.3D_GEb_ES22    | ATMN450B |
| EMEA | Middle East          | LU.SAL0B.074 | AO532h-2Bb EM AOXPHSTME2 MC UMACbk 1*1G/160/6L2.2/5R/CBSD_bg_0.3D_GEb_EN12 | ATMN450B |
| EMEA | Algeria              | LU.SAL0B.072 | AO532h-2Bb EM AOXPHSTDZ1 MC UMACbk 1*1G/160/6L2.2/5R/CBSD_bg_0.3D_GEb_ES81 | ATMN450B |
| EMEA | Eastern Europe       | LU.SAL0B.073 | AO532h-2Bb AOXPHSTEU3 MC UMACbk 1*1G/160/6L2.2/5R/CBSD_bg_0.3D_GEb_RU24    | ATMN450B |
| EMEA | South Africa         | LU.SAL0B.071 | AO532h-2Bb EM AOXPHSTZA1 MC UMACbk 1*1G/160/6L2.2/5R/CBSD_bg_0.3D_GEb_FR22 | ATMN450B |
| EMEA | Holland              | LU.SAL0B.070 | AO532h-2Bb AOXPHSTNL1 MC UMACbk 1*1G/160/6L2.2/5R/CBSD_bg_0.3D_GEb_NL12    | ATMN450B |
| EMEA | Eastern Europe       | LU.SAL0B.069 | AO532h-2Bb AOXPHSTEU5 MC UMACbk 1*1G/160/6L2.2/5R/CBSD_bg_0.3D_GEb_RO12    | ATMN450B |
| EMEA | France               | LU.SAL0B.068 | AO532h-2Bb AOXPHSTFR1 MC UMACbk 1*1G/160/6L2.2/5R/CBSD_bg_0.3D_GEb_FR22    | ATMN450B |
| EMEA | South Africa         | LU.SAL0B.067 | AO532h-2Bb EM AOXPHSTZA2 MC UMACbk 1*1G/160/6L2.2/5R/CBSD_bg_0.3D_GEb_EN12 | ATMN450B |
| EMEA | Norway               | LU.SAL0B.066 | AO532h-2Bb AOXPHSTNO1 MC UMACbk 1*1G/160/6L2.2/5R/CBSD_bg_0.3D_GEb_NO12    | ATMN450B |
| EMEA | Middle East          | LU.SAL0B.065 | AO532h-2Bb EM AOXPHSTME3 MC UMACbk 1*1G/160/6L2.2/5R/CBSD_bg_0.3D_GEb_FR22 | ATMN450B |
| EMEA | Eastern Europe       | LU.SAL0B.064 | AO532h-2Bb AOXPHSTEU7 MC UMACbk 1*1G/160/6L2.2/5R/CBSD_bg_0.3D_GEb_SL11    | ATMN450B |
| EMEA | Eastern Europe       | LU.SAL0B.063 | AO532h-2Bb AOXPHSTEU7 MC UMACbk 1*1G/160/6L2.2/5R/CBSD_bg_0.3D_GEb_EN11    | ATMN450B |
| EMEA | Belgium              | LU.SAL0B.061 | AO532h-2Bb AOXPHSTBE1 MC UMACbk 1*1G/160/6L2.2/5R/CBSD_bg_0.3D_GEb_NL12    | ATMN450B |
| EMEA | Middle East          | LU.SAL0B.062 | AO532h-2Bb EM AOXPHSTME2 MC UMACbk 1*1G/160/6L2.2/5R/CBSD_bg_0.3D_GEb_AR12 | ATMN450B |
| EMEA | Middle East          | LU.SAL0B.060 | AO532h-2Bb EM AOXPHSTME6 MC UMACbk 1*1G/160/6L2.2/5R/CBSD_bg_0.3D_GEb_EN12 | ATMN450B |
| EMEA | Luxembourg           | LU.SAL0B.059 | AO532h-2Bb AOXPHSTLU3 MC UMACbk 1*1G/160/6L2.2/5R/CBSD_bg_0.3D_GEb_IT41    | ATMN450B |
| EMEA | Finland              | LU.SAL0B.058 | AO532h-2Bb AOXPHSTFI2 MC UMACbk 1*1G/160/6L2.2/5R/CBSD_bg_0.3D_GEb_FI11    | ATMN450B |

| RO   | Country              | Acer Part No | Description  | CPU      |
|------|----------------------|--------------|--|----------|
| EMEA | Sweden               | LU.SAL0B.057 | AO532h-2Bb AOXPHSTSE1 MC UMACbk 1*1G/160/6L2.2/5R/CBSD_bg_0.3D_GEb_FI13    | ATMN450B |
| EMEA | Russia               | LU.SAL0B.056 | AO532h-2Bb AOXPHSTRU1 MC UMACbk 1*1G/160/6L2.2/5R/CBSD_bg_0.3D_GEb_RU13    | ATMN450B |
| EMEA | UK                   | LU.SAL0B.055 | AO532h-2Bb AOXPHSTGB1 MC UMACbk 1*1G/160/3L2.2/5R/CBSD_bg_0.3D_GEb_EN12    | ATMN450B |
| EMEA | Denmark              | LU.SAL0B.054 | AO532h-2Bb AOXPHSTDK1 MC UMACbk 1*1G/160/3L2.2/5R/CBSD_bg_0.3D_GEb_NO12    | ATMN450B |
| EMEA | Poland               | LU.SAL0B.053 | AO532h-2Bb AOXPHSTPL1 MC UMACbk 1*1G/160/3L2.2/5R/CBSD_bg_0.3D_GEb_PL11    | ATMN450B |
| EMEA | Italy                | LU.SAL0B.052 | AO532h-2Bb AOXPHSTIT1 MC UMACbk 1*1G/160/3L2.2/5R/CBSD_bg_0.3D_GEb_IT12    | ATMN450B |
| EMEA | Middle East          | LU.SAL0B.051 | AO532h-2Bb EM AOXPHSTME4 MC UMACbk 1*1G/160/3L2.2/5R/CBSD_bg_0.3D_GEb_EN12 | ATMN450B |
| EMEA | Greece               | LU.SAL0B.050 | AO532h-2Bb AOXPHSTGR1 MC UMACbk 1*1G/160/3L2.2/5R/CBSD_bg_0.3D_GEb_EL32    | ATMN450B |
| EMEA | Middle East          | LU.SAL0B.049 | AO532h-2Bb EM AOXPHSTME9 MC UMACbk 1*1G/160/3L2.2/5R/CBSD_bg_0.3D_GEb_FR22 | ATMN450B |
| EMEA | Middle East          | LU.SAL0B.048 | AO532h-2Bb EM AOXPHSTME2 MC UMACbk 1*1G/160/3L2.2/5R/CBSD_bg_0.3D_GEb_AR22 | ATMN450B |
| EMEA | Eastern Europe       | LU.SAL0B.047 | AO532h-2Bb AOXPHSTEU7 MC UMACbk 1*1G/160/3L2.2/5R/CBSD_bg_0.3D_GEb_ENR2    | ATMN450B |
| EMEA | Hungary              | LU.SAL0B.046 | AO532h-2Bb AOXPHSTHU1 MC UMACbk 1*1G/160/3L2.2/5R/CBSD_bg_0.3D_GEb_HU14    | ATMN450B |
| EMEA | Ukraine              | LU.SAL0B.045 | AO532h-2Bb AOXPHSTUK1 MC UMACbk 1*1G/160/3L2.2/5R/CBSD_bg_0.3D_GEb_RU11    | ATMN450B |
| EMEA | Czech                | LU.SAL0B.044 | AO532h-2Bb AOXPHSTCZ2 MC UMACbk 1*1G/160/3L2.2/5R/CBSD_bg_0.3D_GEb_SK14    | ATMN450B |
| EMEA | Russia               | LU.SAL0B.043 | AO532h-2Bb AOXPHSTRU1 MC UMACbk 1*1G/160/3L2.2/5R/CBSD_bg_0.3D_GEb_RU12    | ATMN450B |
| EMEA | Austria              | LU.SAL0B.042 | AO532h-2Bb AOXPHSTAT1 MC UMACbk 1*1G/160/3L2.2/5R/CBSD_bg_0.3D_GEb_DE11    | ATMN450B |
| EMEA | Portugal             | LU.SAL0B.041 | AO532h-2Bb AOXPHSTPT1 MC UMACbk 1*1G/160/3L2.2/5R/CBSD_bg_0.3D_GEb_PT12    | ATMN450B |
| EMEA | Eastern Europe       | LU.SAL0B.040 | AO532h-2Bb AOXPHSTEU5 MC UMACbk 1*1G/160/3L2.2/5R/CBSD_bg_0.3D_GEb_PL14    | ATMN450B |
| EMEA | Eastern Europe       | LU.SAL0B.039 | AO532h-2Bb AOXPHSTEU4 MC UMACbk 1*1G/160/3L2.2/5R/CBSD_bg_0.3D_GEb_FI13    | ATMN450B |
| EMEA | Turkey               | LU.SAL0B.038 | AO532h-2Bb EM AOXPHSTTR1 MC UMACbk 1*1G/160/3L2.2/5R/CBSD_bg_0.3D_GEb_TR33 | ATMN450B |
| EMEA | Denmark              | LU.SAL0B.037 | AO532h-2Bb AOXPHSTDK2 MC UMACbk 1*1G/160/3L2.2/5R/CBSD_bg_0.3D_GEb_ENS1    | ATMN450B |
| EMEA | Russia               | LU.SAL0B.036 | AO532h-2Bb AOXPHSTRU1 MC UMACbk 1*1G/160/3L2.2/5R/CBSD_bg_0.3D_GEb_RU14    | ATMN450B |
| EMEA | Poland               | LU.SAL0B.035 | AO532h-2Bb AOXPHSTPL1 MC UMACbk 1*1G/160/3L2.2/5R/CBSD_bg_0.3D_GEb_PL12    | ATMN450B |
| EMEA | Switzerland          | LU.SAL0B.034 | AO532h-2Bb AOXPHSTCH1 MC UMACbk 1*1G/160/3L2.2/5R/CBSD_bg_0.3D_GEb_IT43    | ATMN450B |
| EMEA | Israel               | LU.SAL0B.033 | AO532h-2Bb AOXPHSTIL1 MC UMACbk 1*1G/160/3L2.2/5R/CBSD_bg_0.3D_GEb_HE13    | ATMN450B |
| EMEA | Latvia               | LU.SAL0B.031 | AO532h-2Bb AOXPHSTLV1 MC UMACbk 1*1G/160/3L2.2/5R/CBSD_bg_0.3D_GEb_RU21    | ATMN450B |
| EMEA | Serbia/<br>Macedonia | LU.SAL0B.030 | AO532h-2Bb EM AOXPHSTCS1 MC UMACbk 1*1G/160/3L2.2/5R/CBSD_bg_0.3D_GEb_SL11 | ATMN450B |

| RO   | Country        | Acer Part No | Description  | CPU      |
|------|----------------|--------------|--|----------|
| EMEA | France         | LU.SAL0B.029 | AO532h-2Bb AOXPHSTFR1 MC UMACbk 1*1G/160/3L2.2/5R/CBSD_bg_0.3D_GEb_FR22    | ATMN450B |
| EMEA | South Africa   | LU.SAL0B.028 | AO532h-2Bb EM AOXPHSTZA2 MC UMACbk 1*1G/160/3L2.2/5R/CBSD_bg_0.3D_GEb_EN12 | ATMN450B |
| EMEA | Norway         | LU.SAL0B.027 | AO532h-2Bb AOXPHSTNO1 MC UMACbk 1*1G/160/3L2.2/5R/CBSD_bg_0.3D_GEb_NO12    | ATMN450B |
| EMEA | Middle East    | LU.SAL0B.026 | AO532h-2Bb EM AOXPHSTME3 MC UMACbk 1*1G/160/3L2.2/5R/CBSD_bg_0.3D_GEb_FR22 | ATMN450B |
| EMEA | Cyprus         | LU.SAL0B.025 | AO532h-2Bb AOXPHSTCY1 MC UMACbk 1*1G/160/3L2.2/5R/CBSD_bg_0.3D_GEb_EN11    | ATMN450B |
| EMEA | Switzerland    | LU.SAL0B.024 | AO532h-2Bb AOXPHSTCH1 MC UMACbk 1*1G/160/3L2.2/5R/CBSD_bg_0.3D_GEb_IT42    | ATMN450B |
| EMEA | Germany        | LU.SAL0B.023 | AO532h-2Bb AOXPHSTDE1 MC UMACbk 1*1G/160/3L2.2/5R/CBSD_bg_0.3D_GEb_DE12    | ATMN450B |
| EMEA | Spain          | LU.SAL0B.022 | AO532h-2Bb AOXPHSTES1 MC UMACbk 1*1G/160/3L2.2/5R/CBSD_bg_0.3D_GEb_ES22    | ATMN450B |
| EMEA | Middle East    | LU.SAL0B.021 | AO532h-2Bb EM AOXPHSTME2 MC UMACbk 1*1G/160/3L2.2/5R/CBSD_bg_0.3D_GEb_EN12 | ATMN450B |
| EMEA | Eastern Europe | LU.SAL0B.020 | AO532h-2Bb AOXPHSTEU3 MC UMACbk 1*1G/160/3L2.2/5R/CBSD_bg_0.3D_GEb_RU24    | ATMN450B |
| EMEA | Algeria        | LU.SAL0B.019 | AO532h-2Bb EM AOXPHSTDZ1 MC UMACbk 1*1G/160/3L2.2/5R/CBSD_bg_0.3D_GEb_ES81 | ATMN450B |
| EMEA | South Africa   | LU.SAL0B.018 | AO532h-2Bb EM AOXPHSTZA1 MC UMACbk 1*1G/160/3L2.2/5R/CBSD_bg_0.3D_GEb_FR22 | ATMN450B |
| EMEA | Holland        | LU.SAL0B.017 | AO532h-2Bb AOXPHSTNL1 MC UMACbk 1*1G/160/3L2.2/5R/CBSD_bg_0.3D_GEb_NL12    | ATMN450B |
| EMEA | Eastern Europe | LU.SAL0B.016 | AO532h-2Bb AOXPHSTEU5 MC UMACbk 1*1G/160/3L2.2/5R/CBSD_bg_0.3D_GEb_RO12    | ATMN450B |
| EMEA | Eastern Europe | LU.SAL0B.015 | AO532h-2Bb AOXPHSTEU7 MC UMACbk 1*1G/160/3L2.2/5R/CBSD_bg_0.3D_GEb_SL11    | ATMN450B |
| EMEA | Eastern Europe | LU.SAL0B.014 | AO532h-2Bb AOXPHSTEU7 MC UMACbk 1*1G/160/3L2.2/5R/CBSD_bg_0.3D_GEb_EN11    | ATMN450B |
| EMEA | Middle East    | LU.SAL0B.013 | AO532h-2Bb EM AOXPHSTME2 MC UMACbk 1*1G/160/3L2.2/5R/CBSD_bg_0.3D_GEb_AR12 | ATMN450B |
| EMEA | Belgium        | LU.SAL0B.012 | AO532h-2Bb AOXPHSTBE1 MC UMACbk 1*1G/160/3L2.2/5R/CBSD_bg_0.3D_GEb_NL12    | ATMN450B |
| EMEA | Middle East    | LU.SAL0B.011 | AO532h-2Bb EM AOXPHSTME6 MC UMACbk 1*1G/160/3L2.2/5R/CBSD_bg_0.3D_GEb_EN12 | ATMN450B |
| EMEA | Luxembourg     | LU.SAL0B.010 | AO532h-2Bb AOXPHSTLU3 MC UMACbk 1*1G/160/3L2.2/5R/CBSD_bg_0.3D_GEb_IT41    | ATMN450B |
| EMEA | Finland        | LU.SAL0B.009 | AO532h-2Bb AOXPHSTFI2 MC UMACbk 1*1G/160/3L2.2/5R/CBSD_bg_0.3D_GEb_FI11    | ATMN450B |
| EMEA | Sweden         | LU.SAL0B.008 | AO532h-2Bb AOXPHSTSE1 MC UMACbk 1*1G/160/3L2.2/5R/CBSD_bg_0.3D_GEb_FI13    | ATMN450B |
| EMEA | Russia         | LU.SAL0B.007 | AO532h-2Bb AOXPHSTRU1 MC UMACbk 1*1G/160/3L2.2/5R/CBSD_bg_0.3D_GEb_RU13    | ATMN450B |
| EMEA | Poland         | LU.SAL0D.063 | AO532h-2Db SNW7ST32STPL1 MC UMACbk 1*1G/160/3L2.2/5R/CBSD_bg_0.3D_GEb_PL11 | ATMN450B |
| EMEA | Israel         | LU.SAL0D.062 | AO532h-2Db SNW7ST32STIL1 MC UMACbk 1*1G/160/3L2.2/5R/CBSD_bg_0.3D_GEb_HE11 | ATMN450B |
| EMEA | Portugal       | LU.SAL0D.061 | AO532h-2Db SNW7ST32STPT1 MC UMACbk 1*1G/160/3L2.2/5R/CBSD_bg_0.3D_GEb_PT11 | ATMN450B |
| EMEA | Luxembourg     | LU.SAL0D.060 | AO532h-2Db SNW7ST32STLU3 MC UMACbk 1*1G/160/3L2.2/5R/CBSD_bg_0.3D_GEb_IT41 | ATMN450B |

| RO   | Country     | Acer Part No | Description   | CPU      |
|------|-------------|--------------|---|----------|
| EMEA | Germany     | LU.SAL0D.059 | AO532h-2Db SNW7ST32STDE1 MC UMACbk 1*1G/160/3L2.2/5R/CBSD_bg_0.3D_Geb_DE13        | ATMN450B |
| EMEA | Holland     | LU.SAL0D.058 | AO532h-2Db SNW7ST32STNL1 MC UMACbk 1*1G/160/3L2.2/5R/CBSD_bg_0.3D_Geb_NL11        | ATMN450B |
| EMEA | Finland     | LU.SAL0D.057 | AO532h-2Db SNW7ST32STFI2 MC UMACbk 1*1G/160/3L2.2/5R/CBSD_bg_0.3D_Geb_FI11        | ATMN450B |
| EMEA | Austria     | LU.SAL0D.056 | AO532h-2Db SNW7ST32STAT1 MC UMACbk 1*1G/160/3L2.2/5R/CBSD_bg_0.3D_Geb_DE61        | ATMN450B |
| EMEA | Italy       | LU.SAL0D.055 | AO532h-2Db SNW7ST32STIT1 MC UMACbk 1*1G/160/3L2.2/5R/CBSD_bg_0.3D_Geb_IT11        | ATMN450B |
| EMEA | Greece      | LU.SAL0D.053 | AO532h-2Db SNW7ST32STGR1 MC UMACbk 1*1G/160/3L2.2/5R/CBSD_bg_0.3D_Geb_EL31        | ATMN450B |
| EMEA | Sweden      | LU.SAL0D.052 | AO532h-2Db SNW7ST32STSE1 MC UMACbk 1*1G/160/3L2.2/5R/CBSD_bg_0.3D_Geb_FI11        | ATMN450B |
| EMEA | Latvia      | LU.SAL0D.051 | AO532h-2Db SNW7ST32STLV1 MC UMACbk 1*1G/160/3L2.2/5R/CBSD_bg_0.3D_Geb_RU21        | ATMN450B |
| EMEA | Germany     | LU.SAL0D.050 | AO532h-2Db SNW7ST32STDE1 MC UMACbk 1*1G/160/3L2.2/5R/CBSD_bg_0.3D_Geb_DE11        | ATMN450B |
| EMEA | France      | LU.SAL0D.049 | AO532h-2Db SNW7ST32STFR1 MC UMACbk 1*1G/160/3L2.2/5R/CBSD_bg_0.3D_Geb_FR21        | ATMN450B |
| EMEA | UK          | LU.SAL0D.048 | AO532h-2Db SNW7ST32STGB1 MC UMACbk 1*1G/160/3L2.2/5R/CBSD_bg_0.3D_Geb_EN11        | ATMN450B |
| EMEA | Switzerland | LU.SAL0D.047 | AO532h-2Db SNW7ST32STCH1 MC UMACbk 1*1G/160/3L2.2/5R/CBSD_bg_0.3D_Geb_IT41        | ATMN450B |
| EMEA | Spain       | LU.SAL0D.046 | AO532h-2Db SNW7ST32STES1 MC UMACbk 1*1G/160/3L2.2/5R/CBSD_bg_0.3D_Geb_ES51        | ATMN450B |
| EMEA | Norway      | LU.SAL0D.045 | AO532h-2Db SNW7ST32STNO1 MC UMACbk 1*1G/160/3L2.2/5R/CBSD_bg_0.3D_Geb_NO11        | ATMN450B |
| EMEA | Hungary     | LU.SAL0D.044 | AO532h-2Db SNW7ST32STHU1 MC UMACbk 1*1G/160/3L2.2/5R/CBSD_bg_0.3D_Geb_HU11        | ATMN450B |
| EMEA | Denmark     | LU.SAL0D.043 | AO532h-2Db SNW7ST32STDK1 MC UMACbk 1*1G/160/3L2.2/5R/CBSD_bg_0.3D_Geb_NO11        | ATMN450B |
| EMEA | Denmark     | LU.SAL0D.042 | AO532h-2Db SNW7ST32STDK2 MC UMACbk 1*1G/160/3L2.2/5R/CBSD_bg_0.3D_Geb_ENS1        | ATMN450B |
| EMEA | Czech       | LU.SAL0D.041 | AO532h-2Db SNW7ST32STCZ2 MC UMACbk 1*1G/160/3L2.2/5R/CBSD_bg_0.3D_Geb_SK11        | ATMN450B |
| EMEA | Cyprus      | LU.SAL0D.040 | AO532h-2Db SNW7ST32STCY1 MC UMACbk 1*1G/160/3L2.2/5R/CBSD_bg_0.3D_Geb_ES61        | ATMN450B |
| EMEA | Belgium     | LU.SAL0D.039 | AO532h-2Db SNW7ST32STBE1 MC UMACbk 1*1G/160/3L2.2/5R/CBSD_bg_0.3D_Geb_NL11        | ATMN450B |
| EMEA | Russia      | LU.SAL0D.025 | AO532h-2Db SNW7ST32RUSTRU1 MC UMACbk 1*1G/160/3L2.2/5R/CBSD_bg_0.3D_Geb_RU62      | ATMN450B |
| EMEA | Ukraine     | LU.SAL0D.026 | AO532h-2Db SNW7ST32RUSTUK1 MC UMACbk 1*1G/160/3L2.2/5R/CBSD_bg_0.3D_Geb_RU61      | ATMN450B |
| EMEA | Russia      | LU.SAL0D.024 | AO532h-2Db SNW7ST32RUSTRU1 MC UMACbk 1*1G/160/3L2.2/5R/CBSD_bg_0.3D_Geb_RU61      | ATMN450B |
| EMEA | Italy       | LU.SAL0B.006 | AO532h-2Bb AOXPHSTIT1 MC UMACbk 1*1G/160/3L2.2/5R/CB_bg_0.3D_Geb_IT12             | ATMN450B |
| EMEA | Germany     | LU.SAL0D.023 | AO532h-2Db SNW7ST32STDE1 MC UMACbk 1*1G/250/BT/6L2.2/5R/bgn_0.3D_BAG_Geb_DE11     | ATMN450B |
| AAP  | India       | LU.SAL0D.022 | AO532h-2Db SNW7ST32INSTIN1 MC UMACbk 1*1G/160/BT/6L2.2/5R/CB_bg_0.3D_BAG_Geb_ES61 | ATMN450B |
| AAP  | India       | LU.SAL0D.021 | AO532h-2Db SNW7ST32INSTIN1 MC UMACbk 1*1G/250/BT/6L2.2/5R/CB_bg_0.3D_BAG_Geb_ES61 | ATMN450B |

| RO    | Country     | Acer Part No | Description  | CPU      |
|-------|-------------|--------------|--|----------|
| AAP   | Japan       | LU.SAL0D.020 | AO532h-2Db SNW7ST32SPJP1 MC UMACbk 1*1G/250/BT/3L2.2/5R/bgn_0.3D_BAG_GEb_JA11_B123F  | ATMN450B |
| AAP   | Japan       | LU.SAL0D.019 | AO532h-2Db SNW7ST32SJP1 MC UMACbk 1*1G/250/BT/6L2.8/5R/bgn_0.3D_BAG_GEb_JA11_B126    | ATMN450B |
| AAP   | Japan       | LU.SAL0D.018 | AO532h-2Db SNW7ST32SJP1 MC UMACbk 1*1G/250/BT/3L2.2/5R/bgn_0.3D_BAG_GEb_JA11_B123    | ATMN450B |
| AAP   | Malaysia    | LU.SAL0D.017 | AO532h-2Db EM SNW7ST32EMSTMY1 MC UMACbk 1*1G/250/BT/6L2.2/5R/CB_bg_0.3D_BAG_GEb_ES61 | ATMN450B |
| EMEA  | UK          | LU.SAL0D.016 | AO532h-2Db SNW7ST32STGB1 MC UMACbk 1*1G/160/6L2.8/5R/CB_bgn_0.3D_GEb_EN11            | ATMN450B |
| EMEA  | UK          | LU.SAL0D.015 | AO532h-2Db SNW7ST32STGB1 MC UMACbk 1*1G/160/6L2.2/5R/bgn_0.3D_GEb_EN11               | ATMN450B |
| EMEA  | UK          | LU.SAL0D.014 | AO532h-2Db SNW7ST32STGB1 MC UMACbk 1*1G/160/3L2.2/5R/CB_bgn_0.3D_GEb_EN11            | ATMN450B |
| EMEA  | UK          | LU.SAL0D.013 | AO532h-2Db SNW7ST32STGB1 MC UMACbk 1*1G/160/6L2.2/5R/CB_bgn_0.3D_GEb_EN11            | ATMN450B |
| EMEA  | France      | LU.SAL0D.012 | AO532h-2Db SNW7ST32STFR1 MC UMACbk 1*1G/250/BT/6L2.2/5R/CB_bgn_0.3D_GEb_FR21         | ATMN450B |
| EMEA  | France      | LU.SAL0D.011 | AO532h-2Db SNW7ST32STFR1 MC UMACbk 1*1G/160/6L2.2/5R/CB_bgn_0.3D_GEb_FR21            | ATMN450B |
| PA    | Canada      | LU.SAL0D.010 | AO532h-2Db SNW7ST32STCA2 MC UMACbk 1*1G/160/3L2.2/5R/CB_bg_0.3D_GEb_FR81             | ATMN450B |
| TWN   | GCTWN       | LU.SAL0D.006 | AO532h-2Db SNW7ST32STTW1 MC UMACbk 1*1G/160/BT/6L2.8/5R/CB_bg_0.3D_BAG_GEb_TC11      | ATMN450B |
| EMEA  | Italy       | LU.SAL0D.009 | AO532h-2Db SNW7ST32STIT1 MC UMACbk 1*1G/250/BT/6L2.8/5R/CB_bg_0.3D_GEb_IT11          | ATMN450B |
| EMEA  | Italy       | LU.SAL0D.008 | AO532h-2Db SNW7ST32STIT1 MC UMACbk 1*1G/250/3L2.2/5R/CB_bg_0.3D_GEb_IT11             | ATMN450B |
| EMEA  | Italy       | LU.SAL0D.007 | AO532h-2Db SNW7ST32STIT1 MC UMACbk 1*1G/250/6L2.2/5R/CB_bg_0.3D_GEb_IT11             | ATMN450B |
| AAP   | Japan       | LU.SAL0D.005 | AO532h-2Db SNW7ST32SJP1 MC UMACbk 1*1G/160/BT/3L2.2/5R/bg_0.3D_BAG_GEb_JA11_bk53     | ATMN450B |
| AAP   | Japan       | LU.SAL0B.005 | AO532h-2Bb AOXPHSJP1 MC UMACbk 1*1G/160/BT/6L2.8/5R/bg_0.3D_BAG_GEb_JA11_bk55        | ATMN450B |
| AAP   | Japan       | LU.SAL0D.004 | AO532h-2Db SNW7ST32SPJP1 MC UMACbk 1*1G/160/BT/6L2.8/5R/bg_0.3D_BAG_GEb_JA11_bk56F   | ATMN450B |
| AAP   | Japan       | LU.SAL0B.004 | AO532h-2Bb AOXPHSJP1 MC UMACbk 1*1G/160/BT/3L2.2/5R/bg_0.3D_BAG_GEb_JA11_Bk52        | ATMN450B |
| AAP   | Japan       | LU.SAL0B.003 | AO532h-2Bb AOXPHSPJP1 MC UMACbk 1*1G/160/BT/6L2.8/5R/bg_0.3D_BAG_GEb_JA11_bk55F      | ATMN450B |
| AAP   | Japan       | LU.SAL0D.003 | AO532h-2Db SNW7ST32SJP1 MC UMACbk 1*1G/160/BT/6L2.8/5R/bg_0.3D_BAG_GEb_JA11_bk56     | ATMN450B |
| CHINA | China       | LU.SAL0B.001 | AO532h-2Bb AOXPHSTCN1 MC UMACbk 1*1G/160/BT/3L2.2/5R/CB_bg_0.3D_BAG_GEb_SC11         | ATMN450B |
| AAP   | Philippines | LU.SAL0D.002 | AO532h-2Db EM SNW7ST32EMSTPH1 MC UMACbk 1*1G/160/BT/6L2.8/5R/CB_bg_0.3D_BAG_GEb_ES61 | ATMN450B |
| AAP   | Philippines | LU.SAL0D.001 | AO532h-2Db EM SNW7ST32EMSTPH1 MC UMACbk 1*1G/250/BT/6L2.8/5R/CB_bg_0.3D_BAG_GEb_ES61 | ATMN450B |
| CHINA | Hong Kong   | LU.SAL0B.002 | AO532h-2Bb AOXPHSTHK2 MC UMACbk 1*1G/160/BT/3L2.2/5R/CB_bg_0.3D_BAG_GEb_ZH31         | ATMN450B |
| AAP   | Vietnam     | LU.SAQ0C.002 | AO532h-2Cr LINPUSSVN1 UMACrk 1*1G/160/BT/3L2.2/5R/CBSD_bg_0.3D_BAG_GEr_ES61          | ATMN450B |

| RO   | Country              | Acer Part No | Description   | CPU      |
|------|----------------------|--------------|---|----------|
| AAP  | Indonesia            | LU.SAQ0D.097 | AO532h-2Dr EM SNW7ST32EMSTID1 MC UMACrk 1*1G/250/BT/6L2.2/5R/CBSD_bg_0.3D_BAG_GEr_ID21  | ATMN450B |
| AAP  | Philippines          | LU.SAQ0D.096 | AO532h-2Dr EM SNW7ST32EMSTPH1 MC UMACrk 1*1G/250/BT/6L2.2/5R/CBSD_bgn_0.3D_BAG_GEr_ES61 | ATMN450B |
| EMEA | Denmark              | LU.SAQ0D.095 | AO532h-2Dr SNW7ST32STDK2 MC UMACrk 1*1G/250/BT/6L2.2/5R/CBSD_bgn_0.3D_GEr_ENS1          | ATMN450B |
| EMEA | Middle East          | LU.SAQ0D.021 | AO532h-2Dr SNW7ST32EMSTME4 MC UMACrk 1*1G/250/3L2.2/5R/CBSD_bg_0.3D_GEr_ES61            | ATMN450B |
| EMEA | Middle East          | LU.SAQ0D.062 | AO532h-2Dr SNW7ST32EMSTME4 MC UMACrk 1*1G/250/BT/6L2.2/5R/CBSD_bg_0.3D_GEr_ES61         | ATMN450B |
| EMEA | South Africa         | LU.SAQ0D.018 | AO532h-2Dr SNW7ST32EMSTZA2 MC UMACrk 1*1G/250/3L2.2/5R/CBSD_bg_0.3D_GEr_ES61            | ATMN450B |
| EMEA | Middle East          | LU.SAQ0D.020 | AO532h-2Dr SNW7ST32EMSTME6 MC UMACrk 1*1G/250/3L2.2/5R/CBSD_bg_0.3D_GEr_ES61            | ATMN450B |
| EMEA | South Africa         | LU.SAQ0D.059 | AO532h-2Dr SNW7ST32EMSTZA2 MC UMACrk 1*1G/250/BT/6L2.2/5R/CBSD_bg_0.3D_GEr_ES61         | ATMN450B |
| EMEA | Middle East          | LU.SAQ0D.061 | AO532h-2Dr SNW7ST32EMSTME6 MC UMACrk 1*1G/250/BT/6L2.2/5R/CBSD_bg_0.3D_GEr_ES61         | ATMN450B |
| EMEA | Middle East          | LU.SAQ0D.013 | AO532h-2Dr SNW7ST32EMSTME2 MC UMACrk 1*1G/250/3L2.2/5R/CBSD_bg_0.3D_GEr_AR11            | ATMN450B |
| EMEA | Middle East          | LU.SAQ0D.014 | AO532h-2Dr SNW7ST32EMSTME2 MC UMACrk 1*1G/250/3L2.2/5R/CBSD_bg_0.3D_GEr_AR21            | ATMN450B |
| EMEA | Middle East          | LU.SAQ0D.024 | AO532h-2Dr SNW7ST32EMSTME2 MC UMACrk 1*1G/250/3L2.2/5R/CBSD_bg_0.3D_GEr_ES61            | ATMN450B |
| EMEA | Middle East          | LU.SAQ0D.054 | AO532h-2Dr SNW7ST32EMSTME2 MC UMACrk 1*1G/250/BT/6L2.2/5R/CBSD_bg_0.3D_GEr_AR11         | ATMN450B |
| EMEA | Middle East          | LU.SAQ0D.055 | AO532h-2Dr SNW7ST32EMSTME2 MC UMACrk 1*1G/250/BT/6L2.2/5R/CBSD_bg_0.3D_GEr_AR21         | ATMN450B |
| EMEA | Middle East          | LU.SAQ0D.065 | AO532h-2Dr SNW7ST32EMSTME2 MC UMACrk 1*1G/250/BT/6L2.2/5R/CBSD_bg_0.3D_GEr_ES61         | ATMN450B |
| EMEA | Middle East          | LU.SAQ0D.016 | AO532h-2Dr SNW7ST32EMSTME3 MC UMACrk 1*1G/250/3L2.2/5R/CBSD_bg_0.3D_GEr_ES81            | ATMN450B |
| EMEA | South Africa         | LU.SAQ0D.017 | AO532h-2Dr SNW7ST32EMSTZA1 MC UMACrk 1*1G/250/3L2.2/5R/CBSD_bg_0.3D_GEr_ES81            | ATMN450B |
| EMEA | Middle East          | LU.SAQ0D.057 | AO532h-2Dr SNW7ST32EMSTME3 MC UMACrk 1*1G/250/BT/6L2.2/5R/CBSD_bg_0.3D_GEr_ES81         | ATMN450B |
| EMEA | South Africa         | LU.SAQ0D.058 | AO532h-2Dr SNW7ST32EMSTZA1 MC UMACrk 1*1G/250/BT/6L2.2/5R/CBSD_bg_0.3D_GEr_ES81         | ATMN450B |
| EMEA | Serbia/<br>Macedonia | LU.SAQ0D.022 | AO532h-2Dr SNW7ST32EMSTCS1 MC UMACrk 1*1G/250/3L2.2/5R/CBSD_bg_0.3D_GEr_SL11            | ATMN450B |
| EMEA | Serbia/<br>Macedonia | LU.SAQ0D.063 | AO532h-2Dr SNW7ST32EMSTCS1 MC UMACrk 1*1G/250/BT/6L2.2/5R/CBSD_bg_0.3D_GEr_SL11         | ATMN450B |
| EMEA | Turkey               | LU.SAQ0D.015 | AO532h-2Dr SNW7ST32EMSTTR1 MC UMACrk 1*1G/250/3L2.2/5R/CBSD_bg_0.3D_GEr_TR31            | ATMN450B |
| EMEA | Turkey               | LU.SAQ0D.056 | AO532h-2Dr SNW7ST32EMSTTR1 MC UMACrk 1*1G/250/BT/6L2.2/5R/CBSD_bg_0.3D_GEr_TR31         | ATMN450B |
| EMEA | Algeria              | LU.SAQ0D.019 | AO532h-2Dr SNW7ST32EMSTDZ1 MC UMACrk 1*1G/250/3L2.2/5R/CBSD_bg_0.3D_GEr_ES81            | ATMN450B |
| EMEA | Middle East          | LU.SAQ0D.023 | AO532h-2Dr SNW7ST32EMSTME9 MC UMACrk 1*1G/250/3L2.2/5R/CBSD_bg_0.3D_GEr_ES81            | ATMN450B |
| EMEA | Algeria              | LU.SAQ0D.060 | AO532h-2Dr SNW7ST32EMSTDZ1 MC UMACrk 1*1G/250/BT/6L2.2/5R/CBSD_bg_0.3D_GEr_ES81         | ATMN450B |

| RO   | Country     | Acer Part No | Description  | CPU      |
|------|-------------|--------------|--|----------|
| EMEA | Middle East | LU.SAQ0D.064 | AO532h-2Dr SNW7ST32EMSTME9 MC UMACrk 1*1G/250/BT/6L2.2/5R/CBSD_bg_0.3D_GEr_ES81    | ATMN450B |
| AAP  | India       | LU.SAQ0C.001 | AO532h-2Cr LINPUSSIN1 UMACrk 1*1G/160/BT/6L2.2/5R/CB_bgn_0.3D_BAG_GEr_ES61         | ATMN450B |
| AAP  | Singapore   | LU.SAQ0D.094 | AO532h-2Dr SNW7ST32STSG1 MC UMACrk 1*1G/250/BT/6L2.2/5R/CBSD_bgn_0.3D_BAG_GEr_ES61 | ATMN450B |
| AAP  | Japan       | LU.SAQ0D.093 | AO532h-2Dr SNW7ST32SJP1 MC UMACrk 1*1G/250/BT/6L2.2/5R/CB_bgn_0.3D_BAG_GEr_JA11    | ATMN450B |
| AAP  | Singapore   | LU.SAQ0D.092 | AO532h-2Dr SNW7ST32STSG1 MC UMACrk 1*1G/250/BT/6L2.2/5R/CB_bgn_0.3D_BAG_GEr_ES61   | ATMN450B |
| AAP  | India       | LU.SAQ0B.101 | AO532h-2Br AOXPHSTIN1 MC UMACrk 1*1G/160/BT/6L2.2/5R/CB_bgn_0.3D_BAG_GEr_EN11      | ATMN450B |
| EMEA | Poland      | LU.SAQ0D.090 | AO532h-2Dr SNW7ST32STPL1 MC UMACrk 1*1G/250/BT/6L2.2/5R/CBSD_bg_0.3D_GEr_PL11      | ATMN450B |
| EMEA | Israel      | LU.SAQ0D.089 | AO532h-2Dr SNW7ST32STIL1 MC UMACrk 1*1G/250/BT/6L2.2/5R/CBSD_bg_0.3D_GEr_HE11      | ATMN450B |
| EMEA | Greece      | LU.SAQ0D.088 | AO532h-2Dr SNW7ST32STGR1 MC UMACrk 1*1G/250/BT/6L2.2/5R/CBSD_bg_0.3D_GEr_EL31      | ATMN450B |
| EMEA | Portugal    | LU.SAQ0D.087 | AO532h-2Dr SNW7ST32STPT1 MC UMACrk 1*1G/250/BT/6L2.2/5R/CBSD_bg_0.3D_GEr_PT11      | ATMN450B |
| EMEA | Luxembourg  | LU.SAQ0D.086 | AO532h-2Dr SNW7ST32STLU3 MC UMACrk 1*1G/250/BT/6L2.2/5R/CBSD_bg_0.3D_GEr_IT41      | ATMN450B |
| EMEA | Germany     | LU.SAQ0D.085 | AO532h-2Dr SNW7ST32STDE1 MC UMACrk 1*1G/250/BT/6L2.2/5R/CBSD_bg_0.3D_GEr_DE13      | ATMN450B |
| EMEA | Holland     | LU.SAQ0D.084 | AO532h-2Dr SNW7ST32STNL1 MC UMACrk 1*1G/250/BT/6L2.2/5R/CBSD_bg_0.3D_GEr_NL11      | ATMN450B |
| EMEA | Finland     | LU.SAQ0D.083 | AO532h-2Dr SNW7ST32STFI2 MC UMACrk 1*1G/250/BT/6L2.2/5R/CBSD_bg_0.3D_GEr_FI11      | ATMN450B |
| EMEA | Austria     | LU.SAQ0D.082 | AO532h-2Dr SNW7ST32STAT1 MC UMACrk 1*1G/250/BT/6L2.2/5R/CBSD_bg_0.3D_GEr_DE61      | ATMN450B |
| EMEA | Italy       | LU.SAQ0D.081 | AO532h-2Dr SNW7ST32STIT1 MC UMACrk 1*1G/250/BT/6L2.2/5R/CBSD_bg_0.3D_GEr_IT11      | ATMN450B |
| EMEA | Latvia      | LU.SAQ0D.079 | AO532h-2Dr SNW7ST32STLV1 MC UMACrk 1*1G/250/BT/6L2.2/5R/CBSD_bg_0.3D_GEr_RU21      | ATMN450B |
| EMEA | Germany     | LU.SAQ0D.078 | AO532h-2Dr SNW7ST32STDE1 MC UMACrk 1*1G/250/BT/6L2.2/5R/CBSD_bg_0.3D_GEr_DE11      | ATMN450B |
| EMEA | France      | LU.SAQ0D.077 | AO532h-2Dr SNW7ST32STFR1 MC UMACrk 1*1G/250/BT/6L2.2/5R/CBSD_bg_0.3D_GEr_FR21      | ATMN450B |
| EMEA | UK          | LU.SAQ0D.076 | AO532h-2Dr SNW7ST32STGB1 MC UMACrk 1*1G/250/BT/6L2.2/5R/CBSD_bg_0.3D_GEr_EN11      | ATMN450B |
| EMEA | Switzerland | LU.SAQ0D.075 | AO532h-2Dr SNW7ST32STCH1 MC UMACrk 1*1G/250/BT/6L2.2/5R/CBSD_bg_0.3D_GEr_IT41      | ATMN450B |
| EMEA | Sweden      | LU.SAQ0D.074 | AO532h-2Dr SNW7ST32STSE1 MC UMACrk 1*1G/250/BT/6L2.2/5R/CBSD_bg_0.3D_GEr_FI11      | ATMN450B |
| EMEA | Norway      | LU.SAQ0D.072 | AO532h-2Dr SNW7ST32STNO1 MC UMACrk 1*1G/250/BT/6L2.2/5R/CBSD_bg_0.3D_GEr_NO11      | ATMN450B |
| EMEA | Spain       | LU.SAQ0D.073 | AO532h-2Dr SNW7ST32STES1 MC UMACrk 1*1G/250/BT/6L2.2/5R/CBSD_bg_0.3D_GEr_ES51      | ATMN450B |
| EMEA | Hungary     | LU.SAQ0D.071 | AO532h-2Dr SNW7ST32STHU1 MC UMACrk 1*1G/250/BT/6L2.2/5R/CBSD_bg_0.3D_GEr_HU11      | ATMN450B |
| EMEA | Denmark     | LU.SAQ0D.070 | AO532h-2Dr SNW7ST32STDK1 MC UMACrk 1*1G/250/BT/6L2.2/5R/CBSD_bg_0.3D_GEr_NO11      | ATMN450B |
| EMEA | Denmark     | LU.SAQ0D.069 | AO532h-2Dr SNW7ST32STDK2 MC UMACrk 1*1G/250/BT/6L2.2/5R/CBSD_bg_0.3D_GEr_ENS1      | ATMN450B |

| RO   | Country     | Acer Part No | Description   | CPU      |
|------|-------------|--------------|---|----------|
| EMEA | Czech       | LU.SAQ0D.068 | AO532h-2Dr SNW7ST32STCZ2 MC UMACrk 1*1G/250/BT/6L2.2/5R/CBSD_bg_0.3D_GEr_SK11   | ATMN450B |
| EMEA | Cyprus      | LU.SAQ0D.067 | AO532h-2Dr SNW7ST32STCY1 MC UMACrk 1*1G/250/BT/6L2.2/5R/CBSD_bg_0.3D_GEr_ES61   | ATMN450B |
| EMEA | Belgium     | LU.SAQ0D.066 | AO532h-2Dr SNW7ST32STBE1 MC UMACrk 1*1G/250/BT/6L2.2/5R/CBSD_bg_0.3D_GEr_NL11   | ATMN450B |
| EMEA | Ukraine     | LU.SAQ0D.053 | AO532h-2Dr SNW7ST32RUSTUK1 MC UMACrk 1*1G/250/BT/6L2.2/5R/CBSD_bg_0.3D_GEr_RU61 | ATMN450B |
| EMEA | Russia      | LU.SAQ0D.052 | AO532h-2Dr SNW7ST32RUSTRU1 MC UMACrk 1*1G/250/BT/6L2.2/5R/CBSD_bg_0.3D_GEr_RU62 | ATMN450B |
| EMEA | Russia      | LU.SAQ0D.051 | AO532h-2Dr SNW7ST32RUSTRU1 MC UMACrk 1*1G/250/BT/6L2.2/5R/CBSD_bg_0.3D_GEr_RU61 | ATMN450B |
| EMEA | Poland      | LU.SAQ0D.049 | AO532h-2Dr SNW7ST32STPL1 MC UMACrk 1*1G/250/3L2.2/5R/CBSD_bg_0.3D_GEr_PL11      | ATMN450B |
| EMEA | Israel      | LU.SAQ0D.048 | AO532h-2Dr SNW7ST32STIL1 MC UMACrk 1*1G/250/3L2.2/5R/CBSD_bg_0.3D_GEr_HE11      | ATMN450B |
| EMEA | Greece      | LU.SAQ0D.047 | AO532h-2Dr SNW7ST32STGR1 MC UMACrk 1*1G/250/3L2.2/5R/CBSD_bg_0.3D_GEr_EL31      | ATMN450B |
| EMEA | Portugal    | LU.SAQ0D.046 | AO532h-2Dr SNW7ST32STPT1 MC UMACrk 1*1G/250/3L2.2/5R/CBSD_bg_0.3D_GEr_PT11      | ATMN450B |
| EMEA | Luxembourg  | LU.SAQ0D.045 | AO532h-2Dr SNW7ST32STLU3 MC UMACrk 1*1G/250/3L2.2/5R/CBSD_bg_0.3D_GEr_IT41      | ATMN450B |
| EMEA | Germany     | LU.SAQ0D.044 | AO532h-2Dr SNW7ST32STDE1 MC UMACrk 1*1G/250/3L2.2/5R/CBSD_bg_0.3D_GEr_DE13      | ATMN450B |
| EMEA | Holland     | LU.SAQ0D.043 | AO532h-2Dr SNW7ST32STNL1 MC UMACrk 1*1G/250/3L2.2/5R/CBSD_bg_0.3D_GEr_NL11      | ATMN450B |
| EMEA | Finland     | LU.SAQ0D.042 | AO532h-2Dr SNW7ST32STFI2 MC UMACrk 1*1G/250/3L2.2/5R/CBSD_bg_0.3D_GEr_FI11      | ATMN450B |
| EMEA | Austria     | LU.SAQ0D.041 | AO532h-2Dr SNW7ST32STAT1 MC UMACrk 1*1G/250/3L2.2/5R/CBSD_bg_0.3D_GEr_DE61      | ATMN450B |
| EMEA | Italy       | LU.SAQ0D.040 | AO532h-2Dr SNW7ST32STIT1 MC UMACrk 1*1G/250/3L2.2/5R/CBSD_bg_0.3D_GEr_IT11      | ATMN450B |
| EMEA | Latvia      | LU.SAQ0D.038 | AO532h-2Dr SNW7ST32STLV1 MC UMACrk 1*1G/250/3L2.2/5R/CBSD_bg_0.3D_GEr_RU21      | ATMN450B |
| EMEA | Germany     | LU.SAQ0D.037 | AO532h-2Dr SNW7ST32STDE1 MC UMACrk 1*1G/250/3L2.2/5R/CBSD_bg_0.3D_GEr_DE11      | ATMN450B |
| EMEA | France      | LU.SAQ0D.036 | AO532h-2Dr SNW7ST32STFR1 MC UMACrk 1*1G/250/3L2.2/5R/CBSD_bg_0.3D_GEr_FR21      | ATMN450B |
| EMEA | UK          | LU.SAQ0D.035 | AO532h-2Dr SNW7ST32STGB1 MC UMACrk 1*1G/250/3L2.2/5R/CBSD_bg_0.3D_GEr_EN11      | ATMN450B |
| EMEA | Switzerland | LU.SAQ0D.034 | AO532h-2Dr SNW7ST32STCH1 MC UMACrk 1*1G/250/3L2.2/5R/CBSD_bg_0.3D_GEr_IT41      | ATMN450B |
| EMEA | Sweden      | LU.SAQ0D.033 | AO532h-2Dr SNW7ST32STSE1 MC UMACrk 1*1G/250/3L2.2/5R/CBSD_bg_0.3D_GEr_FI11      | ATMN450B |
| EMEA | Spain       | LU.SAQ0D.032 | AO532h-2Dr SNW7ST32STES1 MC UMACrk 1*1G/250/3L2.2/5R/CBSD_bg_0.3D_GEr_ES51      | ATMN450B |
| EMEA | Norway      | LU.SAQ0D.031 | AO532h-2Dr SNW7ST32STNO1 MC UMACrk 1*1G/250/3L2.2/5R/CBSD_bg_0.3D_GEr_NO11      | ATMN450B |
| EMEA | Hungary     | LU.SAQ0D.030 | AO532h-2Dr SNW7ST32STHU1 MC UMACrk 1*1G/250/3L2.2/5R/CBSD_bg_0.3D_GEr_HU11      | ATMN450B |
| EMEA | Denmark     | LU.SAQ0D.028 | AO532h-2Dr SNW7ST32STDK2 MC UMACrk 1*1G/250/3L2.2/5R/CBSD_bg_0.3D_GEr_ENS1      | ATMN450B |
| EMEA | Denmark     | LU.SAQ0D.029 | AO532h-2Dr SNW7ST32STDK1 MC UMACrk 1*1G/250/3L2.2/5R/CBSD_bg_0.3D_GEr_NO11      | ATMN450B |



| RO   | Country           | Acer Part No | Description  | CPU      |
|------|-------------------|--------------|--|----------|
| EMEA | Czech             | LU.SAQ0D.027 | AO532h-2Dr SNW7ST32STCZ2 MC UMACrk 1*1G/<br>250/3L2.2/5R/CBSD_bg_0.3D_GEr_SK11   | ATMN450B |
| EMEA | Cyprus            | LU.SAQ0D.026 | AO532h-2Dr SNW7ST32STCY1 MC UMACrk 1*1G/<br>250/3L2.2/5R/CBSD_bg_0.3D_GEr_ES61   | ATMN450B |
| EMEA | Belgium           | LU.SAQ0D.025 | AO532h-2Dr SNW7ST32STBE1 MC UMACrk 1*1G/<br>250/3L2.2/5R/CBSD_bg_0.3D_GEr_NL11   | ATMN450B |
| EMEA | Ukraine           | LU.SAQ0D.012 | AO532h-2Dr SNW7ST32RUSTUK1 MC UMACrk 1*1G/<br>250/3L2.2/5R/CBSD_bg_0.3D_GEr_RU61 | ATMN450B |
| EMEA | Russia            | LU.SAQ0D.011 | AO532h-2Dr SNW7ST32RUSTRU1 MC UMACrk<br>1*1G/250/3L2.2/5R/CBSD_bg_0.3D_GEr_RU62  | ATMN450B |
| EMEA | Russia            | LU.SAQ0D.010 | AO532h-2Dr SNW7ST32RUSTRU1 MC UMACrk<br>1*1G/250/3L2.2/5R/CBSD_bg_0.3D_GEr_RU61  | ATMN450B |
| EMEA | UK                | LU.SAQ0B.099 | AO532h-2Br AOXPHSTGB1 MC UMACrk 1*1G/160/<br>6L2.2/5R/CBSD_bg_0.3D_GEr_EN12      | ATMN450B |
| EMEA | Denmark           | LU.SAQ0B.098 | AO532h-2Br AOXPHSTDK1 MC UMACrk 1*1G/160/<br>6L2.2/5R/CBSD_bg_0.3D_GEr_NO12      | ATMN450B |
| EMEA | Poland            | LU.SAQ0B.097 | AO532h-2Br AOXPHSTPL1 MC UMACrk 1*1G/160/<br>6L2.2/5R/CBSD_bg_0.3D_GEr_PL11      | ATMN450B |
| EMEA | Italy             | LU.SAQ0B.096 | AO532h-2Br AOXPHSTIT1 MC UMACrk 1*1G/160/<br>6L2.2/5R/CBSD_bg_0.3D_GEr_IT12      | ATMN450B |
| EMEA | Middle East       | LU.SAQ0B.095 | AO532h-2Br EM AOXPHSTME4 MC UMACrk 1*1G/<br>160/6L2.2/5R/CBSD_bg_0.3D_GEr_EN12   | ATMN450B |
| EMEA | Greece            | LU.SAQ0B.094 | AO532h-2Br AOXPHSTGR1 MC UMACrk 1*1G/160/<br>6L2.2/5R/CBSD_bg_0.3D_GEr_EL32      | ATMN450B |
| EMEA | Middle East       | LU.SAQ0B.092 | AO532h-2Br EM AOXPHSTME2 MC UMACrk 1*1G/<br>160/6L2.2/5R/CBSD_bg_0.3D_GEr_AR22   | ATMN450B |
| EMEA | Middle East       | LU.SAQ0B.093 | AO532h-2Br EM AOXPHSTME9 MC UMACrk 1*1G/<br>160/6L2.2/5R/CBSD_bg_0.3D_GEr_FR22   | ATMN450B |
| EMEA | Eastern<br>Europe | LU.SAQ0B.091 | AO532h-2Br AOXPHSTEU7 MC UMACrk 1*1G/160/<br>6L2.2/5R/CBSD_bg_0.3D_GEr_ENR2      | ATMN450B |
| EMEA | Hungary           | LU.SAQ0B.090 | AO532h-2Br AOXPHSTHU1 MC UMACrk 1*1G/160/<br>6L2.2/5R/CBSD_bg_0.3D_GEr_HU14      | ATMN450B |
| EMEA | Ukraine           | LU.SAQ0B.089 | AO532h-2Br AOXPHSTUK1 MC UMACrk 1*1G/160/<br>6L2.2/5R/CBSD_bg_0.3D_GEr_RU11      | ATMN450B |
| EMEA | Czech             | LU.SAQ0B.088 | AO532h-2Br AOXPHSTCZ2 MC UMACrk 1*1G/160/<br>6L2.2/5R/CBSD_bg_0.3D_GEr_SK14      | ATMN450B |
| EMEA | Russia            | LU.SAQ0B.087 | AO532h-2Br AOXPHSTRU1 MC UMACrk 1*1G/160/<br>6L2.2/5R/CBSD_bg_0.3D_GEr_RU12      | ATMN450B |
| EMEA | Austria           | LU.SAQ0B.086 | AO532h-2Br AOXPHSTAT1 MC UMACrk 1*1G/160/<br>6L2.2/5R/CBSD_bg_0.3D_GEr_DE11      | ATMN450B |
| EMEA | Portugal          | LU.SAQ0B.085 | AO532h-2Br AOXPHSTPT1 MC UMACrk 1*1G/160/<br>6L2.2/5R/CBSD_bg_0.3D_GEr_PT12      | ATMN450B |
| EMEA | Eastern<br>Europe | LU.SAQ0B.084 | AO532h-2Br AOXPHSTEU5 MC UMACrk 1*1G/160/<br>6L2.2/5R/CBSD_bg_0.3D_GEr_PL14      | ATMN450B |
| EMEA | Eastern<br>Europe | LU.SAQ0B.083 | AO532h-2Br AOXPHSTEU4 MC UMACrk 1*1G/160/<br>6L2.2/5R/CBSD_bg_0.3D_GEr_FI13      | ATMN450B |
| EMEA | Turkey            | LU.SAQ0B.082 | AO532h-2Br EM AOXPHSTTR1 MC UMACrk 1*1G/<br>160/6L2.2/5R/CBSD_bg_0.3D_GEr_TR33   | ATMN450B |
| EMEA | Denmark           | LU.SAQ0B.081 | AO532h-2Br AOXPHSTDK2 MC UMACrk 1*1G/160/<br>6L2.2/5R/CBSD_bg_0.3D_GEr_ENS1      | ATMN450B |
| EMEA | Russia            | LU.SAQ0B.080 | AO532h-2Br AOXPHSTRU1 MC UMACrk 1*1G/160/<br>6L2.2/5R/CBSD_bg_0.3D_GEr_RU14      | ATMN450B |
| EMEA | Poland            | LU.SAQ0B.079 | AO532h-2Br AOXPHSTPL1 MC UMACrk 1*1G/160/<br>6L2.2/5R/CBSD_bg_0.3D_GEr_PL12      | ATMN450B |

| RO   | Country              | Acer Part No | Description  | CPU      |
|------|----------------------|--------------|--|----------|
| EMEA | Switzerland          | LU.SAQ0B.078 | AO532h-2Br AOXPHSTCH1 MC UMACrk 1*1G/160/6L2.2/5R/CBSD_bg_0.3D_GEr_IT43    | ATMN450B |
| EMEA | Israel               | LU.SAQ0B.077 | AO532h-2Br AOXPHSTIL1 MC UMACrk 1*1G/160/6L2.2/5R/CBSD_bg_0.3D_GEr_HE13    | ATMN450B |
| EMEA | Latvia               | LU.SAQ0B.075 | AO532h-2Br AOXPHSTLV1 MC UMACrk 1*1G/160/6L2.2/5R/CBSD_bg_0.3D_GEr_RU21    | ATMN450B |
| EMEA | Serbia/<br>Macedonia | LU.SAQ0B.074 | AO532h-2Br EM AOXPHSTCS1 MC UMACrk 1*1G/160/6L2.2/5R/CBSD_bg_0.3D_GEr_SL11 | ATMN450B |
| EMEA | France               | LU.SAQ0B.073 | AO532h-2Br AOXPHSTFR1 MC UMACrk 1*1G/160/6L2.2/5R/CBSD_bg_0.3D_GEr_FR22    | ATMN450B |
| EMEA | South Africa         | LU.SAQ0B.072 | AO532h-2Br EM AOXPHSTZA2 MC UMACrk 1*1G/160/6L2.2/5R/CBSD_bg_0.3D_GEr_EN12 | ATMN450B |
| EMEA | Norway               | LU.SAQ0B.071 | AO532h-2Br AOXPHSTNO1 MC UMACrk 1*1G/160/6L2.2/5R/CBSD_bg_0.3D_GEr_NO12    | ATMN450B |
| EMEA | Middle East          | LU.SAQ0B.070 | AO532h-2Br EM AOXPHSTME3 MC UMACrk 1*1G/160/6L2.2/5R/CBSD_bg_0.3D_GEr_FR22 | ATMN450B |
| EMEA | Switzerland          | LU.SAQ0B.068 | AO532h-2Br AOXPHSTCH1 MC UMACrk 1*1G/160/6L2.2/5R/CBSD_bg_0.3D_GEr_IT42    | ATMN450B |
| EMEA | Cyprus               | LU.SAQ0B.069 | AO532h-2Br AOXPHSTCY1 MC UMACrk 1*1G/160/6L2.2/5R/CBSD_bg_0.3D_GEr_EN11    | ATMN450B |
| EMEA | Germany              | LU.SAQ0B.067 | AO532h-2Br AOXPHSTDE1 MC UMACrk 1*1G/160/6L2.2/5R/CBSD_bg_0.3D_GEr_DE12    | ATMN450B |
| EMEA | Spain                | LU.SAQ0B.066 | AO532h-2Br AOXPHSTES1 MC UMACrk 1*1G/160/6L2.2/5R/CBSD_bg_0.3D_GEr_ES22    | ATMN450B |
| EMEA | Middle East          | LU.SAQ0B.065 | AO532h-2Br EM AOXPHSTME2 MC UMACrk 1*1G/160/6L2.2/5R/CBSD_bg_0.3D_GEr_EN12 | ATMN450B |
| EMEA | Eastern<br>Europe    | LU.SAQ0B.064 | AO532h-2Br AOXPHSTEU3 MC UMACrk 1*1G/160/6L2.2/5R/CBSD_bg_0.3D_GEr_RU24    | ATMN450B |
| EMEA | South Africa         | LU.SAQ0B.062 | AO532h-2Br EM AOXPHSTZA1 MC UMACrk 1*1G/160/6L2.2/5R/CBSD_bg_0.3D_GEr_FR22 | ATMN450B |
| EMEA | Algeria              | LU.SAQ0B.063 | AO532h-2Br EM AOXPHSTDZ1 MC UMACrk 1*1G/160/6L2.2/5R/CBSD_bg_0.3D_GEr_ES81 | ATMN450B |
| EMEA | Holland              | LU.SAQ0B.061 | AO532h-2Br AOXPHSTNL1 MC UMACrk 1*1G/160/6L2.2/5R/CBSD_bg_0.3D_GEr_NL12    | ATMN450B |
| EMEA | Eastern<br>Europe    | LU.SAQ0B.060 | AO532h-2Br AOXPHSTEU5 MC UMACrk 1*1G/160/6L2.2/5R/CBSD_bg_0.3D_GEr_RO12    | ATMN450B |
| EMEA | Eastern<br>Europe    | LU.SAQ0B.059 | AO532h-2Br AOXPHSTEU7 MC UMACrk 1*1G/160/6L2.2/5R/CBSD_bg_0.3D_GEr_SL11    | ATMN450B |
| EMEA | Eastern<br>Europe    | LU.SAQ0B.058 | AO532h-2Br AOXPHSTEU7 MC UMACrk 1*1G/160/6L2.2/5R/CBSD_bg_0.3D_GEr_EN11    | ATMN450B |
| EMEA | Middle East          | LU.SAQ0B.057 | AO532h-2Br EM AOXPHSTME2 MC UMACrk 1*1G/160/6L2.2/5R/CBSD_bg_0.3D_GEr_AR12 | ATMN450B |
| EMEA | Belgium              | LU.SAQ0B.056 | AO532h-2Br AOXPHSTBE1 MC UMACrk 1*1G/160/6L2.2/5R/CBSD_bg_0.3D_GEr_NL12    | ATMN450B |
| EMEA | Middle East          | LU.SAQ0B.055 | AO532h-2Br EM AOXPHSTME6 MC UMACrk 1*1G/160/6L2.2/5R/CBSD_bg_0.3D_GEr_EN12 | ATMN450B |
| EMEA | Luxembourg           | LU.SAQ0B.054 | AO532h-2Br AOXPHSTLU3 MC UMACrk 1*1G/160/6L2.2/5R/CBSD_bg_0.3D_GEr_IT41    | ATMN450B |
| EMEA | Finland              | LU.SAQ0B.053 | AO532h-2Br AOXPHSTFI2 MC UMACrk 1*1G/160/6L2.2/5R/CBSD_bg_0.3D_GEr_FI11    | ATMN450B |
| EMEA | Sweden               | LU.SAQ0B.052 | AO532h-2Br AOXPHSTSE1 MC UMACrk 1*1G/160/6L2.2/5R/CBSD_bg_0.3D_GEr_FI13    | ATMN450B |
| EMEA | Russia               | LU.SAQ0B.051 | AO532h-2Br AOXPHSTRU1 MC UMACrk 1*1G/160/6L2.2/5R/CBSD_bg_0.3D_GEr_RU13    | ATMN450B |

| RO   | Country              | Acer Part No | Description  | CPU      |
|------|----------------------|--------------|--|----------|
| EMEA | UK                   | LU.SAQ0B.050 | AO532h-2Br AOXPHSTGB1 MC UMACrk 1*1G/160/3L2.2/5R/CBSD_bg_0.3D_GEr_EN12    | ATMN450B |
| EMEA | Poland               | LU.SAQ0B.048 | AO532h-2Br AOXPHSTPL1 MC UMACrk 1*1G/160/3L2.2/5R/CBSD_bg_0.3D_GEr_PL11    | ATMN450B |
| EMEA | Denmark              | LU.SAQ0B.049 | AO532h-2Br AOXPHSTDK1 MC UMACrk 1*1G/160/3L2.2/5R/CBSD_bg_0.3D_GEr_NO12    | ATMN450B |
| EMEA | Italy                | LU.SAQ0B.047 | AO532h-2Br AOXPHSTIT1 MC UMACrk 1*1G/160/3L2.2/5R/CBSD_bg_0.3D_GEr_IT12    | ATMN450B |
| EMEA | Middle East          | LU.SAQ0B.046 | AO532h-2Br EM AOXPHSTME4 MC UMACrk 1*1G/160/3L2.2/5R/CBSD_bg_0.3D_GEr_EN12 | ATMN450B |
| EMEA | Greece               | LU.SAQ0B.045 | AO532h-2Br AOXPHSTGR1 MC UMACrk 1*1G/160/3L2.2/5R/CBSD_bg_0.3D_GEr_EL32    | ATMN450B |
| EMEA | Middle East          | LU.SAQ0B.044 | AO532h-2Br EM AOXPHSTME9 MC UMACrk 1*1G/160/3L2.2/5R/CBSD_bg_0.3D_GEr_FR22 | ATMN450B |
| EMEA | Middle East          | LU.SAQ0B.043 | AO532h-2Br EM AOXPHSTME2 MC UMACrk 1*1G/160/3L2.2/5R/CBSD_bg_0.3D_GEr_AR22 | ATMN450B |
| EMEA | Eastern Europe       | LU.SAQ0B.042 | AO532h-2Br AOXPHSTEU7 MC UMACrk 1*1G/160/3L2.2/5R/CBSD_bg_0.3D_GEr_ENR2    | ATMN450B |
| EMEA | Hungary              | LU.SAQ0B.041 | AO532h-2Br AOXPHSTHU1 MC UMACrk 1*1G/160/3L2.2/5R/CBSD_bg_0.3D_GEr_HU14    | ATMN450B |
| EMEA | Ukraine              | LU.SAQ0B.040 | AO532h-2Br AOXPHSTUK1 MC UMACrk 1*1G/160/3L2.2/5R/CBSD_bg_0.3D_GEr_RU11    | ATMN450B |
| EMEA | Czech                | LU.SAQ0B.039 | AO532h-2Br AOXPHSTCZ2 MC UMACrk 1*1G/160/3L2.2/5R/CBSD_bg_0.3D_GEr_SK14    | ATMN450B |
| EMEA | Russia               | LU.SAQ0B.038 | AO532h-2Br AOXPHSTRU1 MC UMACrk 1*1G/160/3L2.2/5R/CBSD_bg_0.3D_GEr_RU12    | ATMN450B |
| EMEA | Austria              | LU.SAQ0B.037 | AO532h-2Br AOXPHSTAT1 MC UMACrk 1*1G/160/3L2.2/5R/CBSD_bg_0.3D_GEr_DE11    | ATMN450B |
| EMEA | Portugal             | LU.SAQ0B.036 | AO532h-2Br AOXPHSTPT1 MC UMACrk 1*1G/160/3L2.2/5R/CBSD_bg_0.3D_GEr_PT12    | ATMN450B |
| EMEA | Eastern Europe       | LU.SAQ0B.035 | AO532h-2Br AOXPHSTEU5 MC UMACrk 1*1G/160/3L2.2/5R/CBSD_bg_0.3D_GEr_PL14    | ATMN450B |
| EMEA | Eastern Europe       | LU.SAQ0B.034 | AO532h-2Br AOXPHSTEU4 MC UMACrk 1*1G/160/3L2.2/5R/CBSD_bg_0.3D_GEr_FI13    | ATMN450B |
| EMEA | Turkey               | LU.SAQ0B.033 | AO532h-2Br EM AOXPHSTTR1 MC UMACrk 1*1G/160/3L2.2/5R/CBSD_bg_0.3D_GEr_TR33 | ATMN450B |
| EMEA | Denmark              | LU.SAQ0B.032 | AO532h-2Br AOXPHSTDK2 MC UMACrk 1*1G/160/3L2.2/5R/CBSD_bg_0.3D_GEr_ENS1    | ATMN450B |
| EMEA | Russia               | LU.SAQ0B.031 | AO532h-2Br AOXPHSTRU1 MC UMACrk 1*1G/160/3L2.2/5R/CBSD_bg_0.3D_GEr_RU14    | ATMN450B |
| EMEA | Poland               | LU.SAQ0B.030 | AO532h-2Br AOXPHSTPL1 MC UMACrk 1*1G/160/3L2.2/5R/CBSD_bg_0.3D_GEr_PL12    | ATMN450B |
| EMEA | Israel               | LU.SAQ0B.028 | AO532h-2Br AOXPHSTIL1 MC UMACrk 1*1G/160/3L2.2/5R/CBSD_bg_0.3D_GEr_HE13    | ATMN450B |
| EMEA | Switzerland          | LU.SAQ0B.029 | AO532h-2Br AOXPHSTCH1 MC UMACrk 1*1G/160/3L2.2/5R/CBSD_bg_0.3D_GEr_IT43    | ATMN450B |
| EMEA | Latvia               | LU.SAQ0B.026 | AO532h-2Br AOXPHSTLV1 MC UMACrk 1*1G/160/3L2.2/5R/CBSD_bg_0.3D_GEr_RU21    | ATMN450B |
| EMEA | Serbia/<br>Macedonia | LU.SAQ0B.025 | AO532h-2Br EM AOXPHSTCS1 MC UMACrk 1*1G/160/3L2.2/5R/CBSD_bg_0.3D_GEr_SL11 | ATMN450B |
| EMEA | France               | LU.SAQ0B.024 | AO532h-2Br AOXPHSTFR1 MC UMACrk 1*1G/160/3L2.2/5R/CBSD_bg_0.3D_GEr_FR22    | ATMN450B |
| EMEA | South Africa         | LU.SAQ0B.023 | AO532h-2Br EM AOXPHSTZA2 MC UMACrk 1*1G/160/3L2.2/5R/CBSD_bg_0.3D_GEr_EN12 | ATMN450B |

| RO   | Country        | Acer Part No | Description  | CPU      |
|------|----------------|--------------|--|----------|
| EMEA | Norway         | LU.SAQ0B.022 | AO532h-2Br AOXPHSTNO1 MC UMACrk 1*1G/160/3L2.2/5R/CBSD_bg_0.3D_GEr_NO12              | ATMN450B |
| EMEA | Middle East    | LU.SAQ0B.021 | AO532h-2Br EM AOXPHSTME3 MC UMACrk 1*1G/160/3L2.2/5R/CBSD_bg_0.3D_GEr_FR22           | ATMN450B |
| EMEA | Cyprus         | LU.SAQ0B.020 | AO532h-2Br AOXPHSTCY1 MC UMACrk 1*1G/160/3L2.2/5R/CBSD_bg_0.3D_GEr_EN11              | ATMN450B |
| EMEA | Switzerland    | LU.SAQ0B.019 | AO532h-2Br AOXPHSTCH1 MC UMACrk 1*1G/160/3L2.2/5R/CBSD_bg_0.3D_GEr_IT42              | ATMN450B |
| EMEA | Germany        | LU.SAQ0B.018 | AO532h-2Br AOXPHSTDE1 MC UMACrk 1*1G/160/3L2.2/5R/CBSD_bg_0.3D_GEr_DE12              | ATMN450B |
| EMEA | Spain          | LU.SAQ0B.017 | AO532h-2Br AOXPHSTES1 MC UMACrk 1*1G/160/3L2.2/5R/CBSD_bg_0.3D_GEr_ES22              | ATMN450B |
| EMEA | Middle East    | LU.SAQ0B.016 | AO532h-2Br EM AOXPHSTME2 MC UMACrk 1*1G/160/3L2.2/5R/CBSD_bg_0.3D_GEr_EN12           | ATMN450B |
| EMEA | Eastern Europe | LU.SAQ0B.015 | AO532h-2Br AOXPHSTEU3 MC UMACrk 1*1G/160/3L2.2/5R/CBSD_bg_0.3D_GEr_RU24              | ATMN450B |
| EMEA | Algeria        | LU.SAQ0B.014 | AO532h-2Br EM AOXPHSTDZ1 MC UMACrk 1*1G/160/3L2.2/5R/CBSD_bg_0.3D_GEr_ES81           | ATMN450B |
| EMEA | South Africa   | LU.SAQ0B.013 | AO532h-2Br EM AOXPHSTZA1 MC UMACrk 1*1G/160/3L2.2/5R/CBSD_bg_0.3D_GEr_FR22           | ATMN450B |
| EMEA | Holland        | LU.SAQ0B.012 | AO532h-2Br AOXPHSTNL1 MC UMACrk 1*1G/160/3L2.2/5R/CBSD_bg_0.3D_GEr_NL12              | ATMN450B |
| EMEA | Eastern Europe | LU.SAQ0B.011 | AO532h-2Br AOXPHSTEU5 MC UMACrk 1*1G/160/3L2.2/5R/CBSD_bg_0.3D_GEr_RO12              | ATMN450B |
| EMEA | Eastern Europe | LU.SAQ0B.010 | AO532h-2Br AOXPHSTEU7 MC UMACrk 1*1G/160/3L2.2/5R/CBSD_bg_0.3D_GEr_SL11              | ATMN450B |
| EMEA | Eastern Europe | LU.SAQ0B.009 | AO532h-2Br AOXPHSTEU7 MC UMACrk 1*1G/160/3L2.2/5R/CBSD_bg_0.3D_GEr_EN11              | ATMN450B |
| EMEA | Middle East    | LU.SAQ0B.008 | AO532h-2Br EM AOXPHSTME2 MC UMACrk 1*1G/160/3L2.2/5R/CBSD_bg_0.3D_GEr_AR12           | ATMN450B |
| EMEA | Belgium        | LU.SAQ0B.007 | AO532h-2Br AOXPHSTBE1 MC UMACrk 1*1G/160/3L2.2/5R/CBSD_bg_0.3D_GEr_NL12              | ATMN450B |
| EMEA | Middle East    | LU.SAQ0B.006 | AO532h-2Br EM AOXPHSTME6 MC UMACrk 1*1G/160/3L2.2/5R/CBSD_bg_0.3D_GEr_EN12           | ATMN450B |
| EMEA | Luxembourg     | LU.SAQ0B.005 | AO532h-2Br AOXPHSTLU3 MC UMACrk 1*1G/160/3L2.2/5R/CBSD_bg_0.3D_GEr_IT41              | ATMN450B |
| EMEA | Finland        | LU.SAQ0B.004 | AO532h-2Br AOXPHSTFI2 MC UMACrk 1*1G/160/3L2.2/5R/CBSD_bg_0.3D_GEr_FL11              | ATMN450B |
| EMEA | Sweden         | LU.SAQ0B.003 | AO532h-2Br AOXPHSTSE1 MC UMACrk 1*1G/160/3L2.2/5R/CBSD_bg_0.3D_GEr_FL13              | ATMN450B |
| EMEA | Russia         | LU.SAQ0B.002 | AO532h-2Br AOXPHSTRU1 MC UMACrk 1*1G/160/3L2.2/5R/CBSD_bg_0.3D_GEr_RU13              | ATMN450B |
| EMEA | Germany        | LU.SAQ0D.009 | AO532h-2Dr SNW7ST32STDE1 MC UMACrk 1*1G/250/BT/6L2.8/5R/bgn_0.3D_BAG_GEr_DE11        | ATMN450B |
| EMEA | Italy          | LU.SAQ0B.001 | AO532h-2Br AOXPHSTIT1 MC UMACrk 1*1G/160/3L2.2/5R/CB_bg_0.3D_GEr_IT12                | ATMN450B |
| AAP  | Japan          | LU.SAQ0D.008 | AO532h-2Dr SNW7ST32SJP1 MC UMACrk 1*1G/250/BT/6L2.8/5R/bgn_0.3D_BAG_GEr_JA11_R126    | ATMN450B |
| AAP  | Japan          | LU.SAQ0D.007 | AO532h-2Dr SNW7ST32SPJP1 MC UMACrk 1*1G/250/BT/3L2.2/5R/bgn_0.3D_BAG_GEr_JA11_R123F  | ATMN450B |
| AAP  | Japan          | LU.SAQ0D.006 | AO532h-2Dr SNW7ST32SJP1 MC UMACrk 1*1G/250/BT/3L2.2/5R/bgn_0.3D_BAG_GEr_JA11_R123    | ATMN450B |
| AAP  | Malaysia       | LU.SAQ0D.005 | AO532h-2Dr EM SNW7ST32EMSTMY1 MC UMACrk 1*1G/250/BT/6L2.2/5R/CB_bg_0.3D_BAG_GEr_ES61 | ATMN450B |

| RO   | Country          | Acer Part No | Description   | CPU      |
|------|------------------|--------------|---|----------|
| EMEA | France           | LU.SAQ0D.004 | AO532h-2Dr SNW7ST32STFR1 MC UMACrk 1*1G/250/BT/6L2.2/5R/CB_bgn_0.3D_GEr_FR21            | ATMN450B |
| EMEA | France           | LU.SAQ0D.003 | AO532h-2Dr SNW7ST32STFR1 MC UMACrk 1*1G/160/6L2.2/5R/CB_bgn_0.3D_GEr_FR21               | ATMN450B |
| EMEA | Italy            | LU.SAQ0D.002 | AO532h-2Dr SNW7ST32STIT1 MC UMACrk 1*1G/250/BT/6L2.8/5R/CB_bg_0.3D_GEr_IT11             | ATMN450B |
| EMEA | Italy            | LU.SAQ0D.001 | AO532h-2Dr SNW7ST32STIT1 MC UMACrk 1*1G/250/3L2.2/5R/CB_bg_0.3D_GEr_IT11                | ATMN450B |
| AAP  | Thailand         | LU.SAS0D.105 | AO532h-2Ds EM SNW7ST32EMSTTH1 MC UMACsw 1*1G/250/BT/6L2.8/5R/CB_bgn_0.3D_BAG_GEs_TH41   | ATMN450B |
| AAP  | Vietnam          | LU.SAS0C.001 | AO532h-2Cs LINPUSSVN1 UMACsw 1*1G/160/BT/3L2.2/5R/CBSD_bg_0.3D_BAG_GEs_ES61             | ATMN450B |
| AAP  | Indonesia        | LU.SAS0D.104 | AO532h-2Ds EM SNW7ST32EMSTID1 MC UMACsw 1*1G/250/BT/6L2.2/5R/CBSD_bg_0.3D_BAG_GEs_ID21  | ATMN450B |
| PA   | USA              | LU.SAS0D.103 | AO532h-2Ds SNW7ST32STUS1 MC UMACsw 1*1G/160/3L2.2/5R/CBSD_bgn_0.3D_GEs_FRB2             | ATMN450B |
| AAP  | Philippines      | LU.SAS0D.102 | AO532h-2Ds EM SNW7ST32EMSTPH1 MC UMACsw 1*1G/250/BT/6L2.2/5R/CBSD_bgn_0.3D_BAG_GEs_ES61 | ATMN450B |
| EMEA | Denmark          | LU.SAS0D.101 | AO532h-2Ds SNW7ST32STDK2 MC UMACsw 1*1G/250/BT/6L2.2/5R/CBSD_bgn_0.3D_GEs_ENS1          | ATMN450B |
| EMEA | South Africa     | LU.SAS0D.059 | AO532h-2Ds SNW7ST32EMSTZA2 MC UMACsw 1*1G/250/BT/6L2.2/5R/CBSD_bg_0.3D_GEs_ES61         | ATMN450B |
| EMEA | Middle East      | LU.SAS0D.061 | AO532h-2Ds SNW7ST32EMSTME6 MC UMACsw 1*1G/250/BT/6L2.2/5R/CBSD_bg_0.3D_GEs_ES61         | ATMN450B |
| EMEA | South Africa     | LU.SAS0D.018 | AO532h-2Ds SNW7ST32EMSTZA2 MC UMACsw 1*1G/250/3L2.2/5R/CBSD_bg_0.3D_GEs_ES61            | ATMN450B |
| EMEA | Middle East      | LU.SAS0D.020 | AO532h-2Ds SNW7ST32EMSTME6 MC UMACsw 1*1G/250/3L2.2/5R/CBSD_bg_0.3D_GEs_ES61            | ATMN450B |
| EMEA | Middle East      | LU.SAS0D.054 | AO532h-2Ds SNW7ST32EMSTME2 MC UMACsw 1*1G/250/BT/6L2.2/5R/CBSD_bg_0.3D_GEs_AR11         | ATMN450B |
| EMEA | Middle East      | LU.SAS0D.055 | AO532h-2Ds SNW7ST32EMSTME2 MC UMACsw 1*1G/250/BT/6L2.2/5R/CBSD_bg_0.3D_GEs_AR21         | ATMN450B |
| EMEA | Middle East      | LU.SAS0D.065 | AO532h-2Ds SNW7ST32EMSTME2 MC UMACsw 1*1G/250/BT/6L2.2/5R/CBSD_bg_0.3D_GEs_ES61         | ATMN450B |
| EMEA | Middle East      | LU.SAS0D.013 | AO532h-2Ds SNW7ST32EMSTME2 MC UMACsw 1*1G/250/3L2.2/5R/CBSD_bg_0.3D_GEs_AR11            | ATMN450B |
| EMEA | Middle East      | LU.SAS0D.014 | AO532h-2Ds SNW7ST32EMSTME2 MC UMACsw 1*1G/250/3L2.2/5R/CBSD_bg_0.3D_GEs_AR21            | ATMN450B |
| EMEA | Serbia/Macedonia | LU.SAS0D.063 | AO532h-2Ds SNW7ST32EMSTCS1 MC UMACsw 1*1G/250/BT/6L2.2/5R/CBSD_bg_0.3D_GEs_SL11         | ATMN450B |
| EMEA | Serbia/Macedonia | LU.SAS0D.022 | AO532h-2Ds SNW7ST32EMSTCS1 MC UMACsw 1*1G/250/3L2.2/5R/CBSD_bg_0.3D_GEs_SL11            | ATMN450B |
| EMEA | Turkey           | LU.SAS0D.056 | AO532h-2Ds SNW7ST32EMSTTR1 MC UMACsw 1*1G/250/BT/6L2.2/5R/CBSD_bg_0.3D_GEs_TR31         | ATMN450B |
| EMEA | Turkey           | LU.SAS0D.015 | AO532h-2Ds SNW7ST32EMSTTR1 MC UMACsw 1*1G/250/3L2.2/5R/CBSD_bg_0.3D_GEs_TR31            | ATMN450B |
| EMEA | Middle East      | LU.SAS0D.062 | AO532h-2Ds SNW7ST32EMSTME4 MC UMACsw 1*1G/250/BT/6L2.2/5R/CBSD_bg_0.3D_GEs_ES61         | ATMN450B |
| EMEA | Middle East      | LU.SAS0D.021 | AO532h-2Ds SNW7ST32EMSTME4 MC UMACsw 1*1G/250/3L2.2/5R/CBSD_bg_0.3D_GEs_ES61            | ATMN450B |
| EMEA | Middle East      | LU.SAS0D.024 | AO532h-2Ds SNW7ST32EMSTME2 MC UMACsw 1*1G/250/3L2.2/5R/CBSD_bg_0.3D_GEs_ES61            | ATMN450B |

| RO   | Country      | Acer Part No | Description  | CPU      |
|------|--------------|--------------|--|----------|
| EMEA | Algeria      | LU.SAS0D.060 | AO532h-2Ds SNW7ST32EMSTDZ1 MC UMACsw 1*1G/250/BT/6L2.2/5R/CBSD_bg_0.3D_GEs_ES81    | ATMN450B |
| EMEA | Middle East  | LU.SAS0D.064 | AO532h-2Ds SNW7ST32EMSTME9 MC UMACsw 1*1G/250/BT/6L2.2/5R/CBSD_bg_0.3D_GEs_ES81    | ATMN450B |
| EMEA | Algeria      | LU.SAS0D.019 | AO532h-2Ds SNW7ST32EMSTDZ1 MC UMACsw 1*1G/250/3L2.2/5R/CBSD_bg_0.3D_GEs_ES81       | ATMN450B |
| EMEA | Middle East  | LU.SAS0D.023 | AO532h-2Ds SNW7ST32EMSTME9 MC UMACsw 1*1G/250/3L2.2/5R/CBSD_bg_0.3D_GEs_ES81       | ATMN450B |
| EMEA | Middle East  | LU.SAS0D.057 | AO532h-2Ds SNW7ST32EMSTME3 MC UMACsw 1*1G/250/BT/6L2.2/5R/CBSD_bg_0.3D_GEs_ES81    | ATMN450B |
| EMEA | South Africa | LU.SAS0D.058 | AO532h-2Ds SNW7ST32EMSTZA1 MC UMACsw 1*1G/250/BT/6L2.2/5R/CBSD_bg_0.3D_GEs_ES81    | ATMN450B |
| EMEA | Middle East  | LU.SAS0D.016 | AO532h-2Ds SNW7ST32EMSTME3 MC UMACsw 1*1G/250/3L2.2/5R/CBSD_bg_0.3D_GEs_ES81       | ATMN450B |
| EMEA | South Africa | LU.SAS0D.017 | AO532h-2Ds SNW7ST32EMSTZA1 MC UMACsw 1*1G/250/3L2.2/5R/CBSD_bg_0.3D_GEs_ES81       | ATMN450B |
| AAP  | Singapore    | LU.SAS0D.099 | AO532h-2Ds SNW7ST32STSG1 MC UMACsw 1*1G/250/BT/6L2.2/5R/CBSD_bgn_0.3D_BAG_GEs_ES61 | ATMN450B |
| AAP  | Japan        | LU.SAS0D.098 | AO532h-2Ds SNW7ST32SJP1 MC UMACsw 1*1G/250/BT/6L2.2/5R/CB_bgn_0.3D_BAG_GEs_JA11    | ATMN450B |
| AAP  | Singapore    | LU.SAS0D.097 | AO532h-2Ds SNW7ST32STSG1 MC UMACsw 1*1G/250/BT/6L2.2/5R/CB_bgn_0.3D_BAG_GEs_ES61   | ATMN450B |
| EMEA | France       | LU.SAS0D.096 | AO532h-2Ds SNW7ST32STFR1 MC UMACsw 1*1G/160/6L2.2/5R/CBSD_bg_0.3D_GEs_FR21         | ATMN450B |
| EMEA | France       | LU.SAS0D.095 | AO532h-2Ds SNW7ST32STFR1 MC UMACsw 1*1G/160/3L2.2/5R/CBSD_bg_0.3D_GEs_FR21         | ATMN450B |
| EMEA | Luxembourg   | LU.SAS0D.094 | AO532h-2Ds SNW7ST32STLU3 MC UMACsw 1*1G/160/3L2.2/5R/CBSD_bgn_0.3D_GEs_IT41        | ATMN450B |
| EMEA | Holland      | LU.SAS0D.093 | AO532h-2Ds SNW7ST32STNL1 MC UMACsw 1*1G/160/3L2.2/5R/CBSD_bgn_0.3D_GEs_NL11        | ATMN450B |
| EMEA | Belgium      | LU.SAS0D.092 | AO532h-2Ds SNW7ST32STBE1 MC UMACsw 1*1G/160/3L2.2/5R/CBSD_bgn_0.3D_GEs_NL11        | ATMN450B |
| EMEA | Poland       | LU.SAS0D.090 | AO532h-2Ds SNW7ST32STPL1 MC UMACsw 1*1G/250/BT/6L2.2/5R/CBSD_bg_0.3D_GEs_PL11      | ATMN450B |
| EMEA | Greece       | LU.SAS0D.088 | AO532h-2Ds SNW7ST32STGR1 MC UMACsw 1*1G/250/BT/6L2.2/5R/CBSD_bg_0.3D_GEs_EL31      | ATMN450B |
| EMEA | Israel       | LU.SAS0D.089 | AO532h-2Ds SNW7ST32STIL1 MC UMACsw 1*1G/250/BT/6L2.2/5R/CBSD_bg_0.3D_GEs_HE11      | ATMN450B |
| EMEA | Portugal     | LU.SAS0D.087 | AO532h-2Ds SNW7ST32STPT1 MC UMACsw 1*1G/250/BT/6L2.2/5R/CBSD_bg_0.3D_GEs_PT11      | ATMN450B |
| EMEA | Luxembourg   | LU.SAS0D.086 | AO532h-2Ds SNW7ST32STLU3 MC UMACsw 1*1G/250/BT/6L2.2/5R/CBSD_bg_0.3D_GEs_IT41      | ATMN450B |
| EMEA | Germany      | LU.SAS0D.085 | AO532h-2Ds SNW7ST32STDE1 MC UMACsw 1*1G/250/BT/6L2.2/5R/CBSD_bg_0.3D_GEs_DE13      | ATMN450B |
| EMEA | Finland      | LU.SAS0D.083 | AO532h-2Ds SNW7ST32STFI2 MC UMACsw 1*1G/250/BT/6L2.2/5R/CBSD_bg_0.3D_GEs_FI11      | ATMN450B |
| EMEA | Holland      | LU.SAS0D.084 | AO532h-2Ds SNW7ST32STNL1 MC UMACsw 1*1G/250/BT/6L2.2/5R/CBSD_bg_0.3D_GEs_NL11      | ATMN450B |
| EMEA | Austria      | LU.SAS0D.082 | AO532h-2Ds SNW7ST32STAT1 MC UMACsw 1*1G/250/BT/6L2.2/5R/CBSD_bg_0.3D_GEs_DE61      | ATMN450B |
| EMEA | Italy        | LU.SAS0D.081 | AO532h-2Ds SNW7ST32STIT1 MC UMACsw 1*1G/250/BT/6L2.2/5R/CBSD_bg_0.3D_GEs_IT11      | ATMN450B |
| EMEA | Latvia       | LU.SAS0D.079 | AO532h-2Ds SNW7ST32STLV1 MC UMACsw 1*1G/250/BT/6L2.2/5R/CBSD_bg_0.3D_GEs_RU21      | ATMN450B |

| RO   | Country     | Acer Part No | Description   | CPU      |
|------|-------------|--------------|---|----------|
| EMEA | Germany     | LU.SAS0D.078 | AO532h-2Ds SNW7ST32STDE1 MC UMACsw 1*1G/250/BT/6L2.2/5R/CBSD_bg_0.3D_GEs_DE11   | ATMN450B |
| EMEA | France      | LU.SAS0D.077 | AO532h-2Ds SNW7ST32STFR1 MC UMACsw 1*1G/250/BT/6L2.2/5R/CBSD_bg_0.3D_GEs_FR21   | ATMN450B |
| EMEA | UK          | LU.SAS0D.076 | AO532h-2Ds SNW7ST32STGB1 MC UMACsw 1*1G/250/BT/6L2.2/5R/CBSD_bg_0.3D_GEs_EN11   | ATMN450B |
| EMEA | Switzerland | LU.SAS0D.075 | AO532h-2Ds SNW7ST32STCH1 MC UMACsw 1*1G/250/BT/6L2.2/5R/CBSD_bg_0.3D_GEs_IT41   | ATMN450B |
| EMEA | Sweden      | LU.SAS0D.074 | AO532h-2Ds SNW7ST32STSE1 MC UMACsw 1*1G/250/BT/6L2.2/5R/CBSD_bg_0.3D_GEs_FI11   | ATMN450B |
| EMEA | Norway      | LU.SAS0D.072 | AO532h-2Ds SNW7ST32STNO1 MC UMACsw 1*1G/250/BT/6L2.2/5R/CBSD_bg_0.3D_GEs_NO11   | ATMN450B |
| EMEA | Spain       | LU.SAS0D.073 | AO532h-2Ds SNW7ST32STES1 MC UMACsw 1*1G/250/BT/6L2.2/5R/CBSD_bg_0.3D_GEs_ES51   | ATMN450B |
| EMEA | Hungary     | LU.SAS0D.071 | AO532h-2Ds SNW7ST32STHU1 MC UMACsw 1*1G/250/BT/6L2.2/5R/CBSD_bg_0.3D_GEs_HU11   | ATMN450B |
| EMEA | Denmark     | LU.SAS0D.070 | AO532h-2Ds SNW7ST32STDK1 MC UMACsw 1*1G/250/BT/6L2.2/5R/CBSD_bg_0.3D_GEs_NO11   | ATMN450B |
| EMEA | Denmark     | LU.SAS0D.069 | AO532h-2Ds SNW7ST32STDK2 MC UMACsw 1*1G/250/BT/6L2.2/5R/CBSD_bg_0.3D_GEs_ENS1   | ATMN450B |
| EMEA | Czech       | LU.SAS0D.068 | AO532h-2Ds SNW7ST32STCZ2 MC UMACsw 1*1G/250/BT/6L2.2/5R/CBSD_bg_0.3D_GEs_SK11   | ATMN450B |
| EMEA | Cyprus      | LU.SAS0D.067 | AO532h-2Ds SNW7ST32STCY1 MC UMACsw 1*1G/250/BT/6L2.2/5R/CBSD_bg_0.3D_GEs_ES61   | ATMN450B |
| EMEA | Belgium     | LU.SAS0D.066 | AO532h-2Ds SNW7ST32STBE1 MC UMACsw 1*1G/250/BT/6L2.2/5R/CBSD_bg_0.3D_GEs_NL11   | ATMN450B |
| EMEA | Ukraine     | LU.SAS0D.053 | AO532h-2Ds SNW7ST32RUSTUK1 MC UMACsw 1*1G/250/BT/6L2.2/5R/CBSD_bg_0.3D_GEs_RU61 | ATMN450B |
| EMEA | Russia      | LU.SAS0D.052 | AO532h-2Ds SNW7ST32RUSTRU1 MC UMACsw 1*1G/250/BT/6L2.2/5R/CBSD_bg_0.3D_GEs_RU62 | ATMN450B |
| EMEA | Russia      | LU.SAS0D.051 | AO532h-2Ds SNW7ST32RUSTRU1 MC UMACsw 1*1G/250/BT/6L2.2/5R/CBSD_bg_0.3D_GEs_RU61 | ATMN450B |
| EMEA | Poland      | LU.SAS0D.049 | AO532h-2Ds SNW7ST32STPL1 MC UMACsw 1*1G/250/3L2.2/5R/CBSD_bg_0.3D_GEs_PL11      | ATMN450B |
| EMEA | Israel      | LU.SAS0D.048 | AO532h-2Ds SNW7ST32STIL1 MC UMACsw 1*1G/250/3L2.2/5R/CBSD_bg_0.3D_GEs_HE11      | ATMN450B |
| EMEA | Greece      | LU.SAS0D.047 | AO532h-2Ds SNW7ST32STGR1 MC UMACsw 1*1G/250/3L2.2/5R/CBSD_bg_0.3D_GEs_EL31      | ATMN450B |
| EMEA | Portugal    | LU.SAS0D.046 | AO532h-2Ds SNW7ST32STPT1 MC UMACsw 1*1G/250/3L2.2/5R/CBSD_bg_0.3D_GEs_PT11      | ATMN450B |
| EMEA | Luxembourg  | LU.SAS0D.045 | AO532h-2Ds SNW7ST32STLU3 MC UMACsw 1*1G/250/3L2.2/5R/CBSD_bg_0.3D_GEs_IT41      | ATMN450B |
| EMEA | Germany     | LU.SAS0D.044 | AO532h-2Ds SNW7ST32STDE1 MC UMACsw 1*1G/250/3L2.2/5R/CBSD_bg_0.3D_GEs_DE13      | ATMN450B |
| EMEA | Holland     | LU.SAS0D.043 | AO532h-2Ds SNW7ST32STNL1 MC UMACsw 1*1G/250/3L2.2/5R/CBSD_bg_0.3D_GEs_NL11      | ATMN450B |
| EMEA | Finland     | LU.SAS0D.042 | AO532h-2Ds SNW7ST32STFI2 MC UMACsw 1*1G/250/3L2.2/5R/CBSD_bg_0.3D_GEs_FI11      | ATMN450B |
| EMEA | Austria     | LU.SAS0D.041 | AO532h-2Ds SNW7ST32STAT1 MC UMACsw 1*1G/250/3L2.2/5R/CBSD_bg_0.3D_GEs_DE61      | ATMN450B |
| EMEA | Italy       | LU.SAS0D.040 | AO532h-2Ds SNW7ST32STIT1 MC UMACsw 1*1G/250/3L2.2/5R/CBSD_bg_0.3D_GEs_IT11      | ATMN450B |
| EMEA | Latvia      | LU.SAS0D.038 | AO532h-2Ds SNW7ST32STLV1 MC UMACsw 1*1G/250/3L2.2/5R/CBSD_bg_0.3D_GEs_RU21      | ATMN450B |

| RO   | Country        | Acer Part No | Description  | CPU      |
|------|----------------|--------------|--|----------|
| EMEA | Germany        | LU.SAS0D.037 | AO532h-2Ds SNW7ST32STDE1 MC UMACsw 1*1G/250/3L2.2/5R/CBSD_bg_0.3D_GEs_DE11   | ATMN450B |
| EMEA | France         | LU.SAS0D.036 | AO532h-2Ds SNW7ST32STFR1 MC UMACsw 1*1G/250/3L2.2/5R/CBSD_bg_0.3D_GEs_FR21   | ATMN450B |
| EMEA | UK             | LU.SAS0D.035 | AO532h-2Ds SNW7ST32STGB1 MC UMACsw 1*1G/250/3L2.2/5R/CBSD_bg_0.3D_GEs_EN11   | ATMN450B |
| EMEA | Switzerland    | LU.SAS0D.034 | AO532h-2Ds SNW7ST32STCH1 MC UMACsw 1*1G/250/3L2.2/5R/CBSD_bg_0.3D_GEs_IT41   | ATMN450B |
| EMEA | Sweden         | LU.SAS0D.033 | AO532h-2Ds SNW7ST32STSE1 MC UMACsw 1*1G/250/3L2.2/5R/CBSD_bg_0.3D_GEs_FI11   | ATMN450B |
| EMEA | Spain          | LU.SAS0D.032 | AO532h-2Ds SNW7ST32STES1 MC UMACsw 1*1G/250/3L2.2/5R/CBSD_bg_0.3D_GEs_ES51   | ATMN450B |
| EMEA | Norway         | LU.SAS0D.031 | AO532h-2Ds SNW7ST32STNO1 MC UMACsw 1*1G/250/3L2.2/5R/CBSD_bg_0.3D_GEs_NO11   | ATMN450B |
| EMEA | Hungary        | LU.SAS0D.030 | AO532h-2Ds SNW7ST32STHU1 MC UMACsw 1*1G/250/3L2.2/5R/CBSD_bg_0.3D_GEs_HU11   | ATMN450B |
| EMEA | Denmark        | LU.SAS0D.029 | AO532h-2Ds SNW7ST32STDK1 MC UMACsw 1*1G/250/3L2.2/5R/CBSD_bg_0.3D_GEs_NO11   | ATMN450B |
| EMEA | Denmark        | LU.SAS0D.028 | AO532h-2Ds SNW7ST32STDK2 MC UMACsw 1*1G/250/3L2.2/5R/CBSD_bg_0.3D_GEs_ENS1   | ATMN450B |
| EMEA | Cyprus         | LU.SAS0D.026 | AO532h-2Ds SNW7ST32STCY1 MC UMACsw 1*1G/250/3L2.2/5R/CBSD_bg_0.3D_GEs_ES61   | ATMN450B |
| EMEA | Czech          | LU.SAS0D.027 | AO532h-2Ds SNW7ST32STCZ2 MC UMACsw 1*1G/250/3L2.2/5R/CBSD_bg_0.3D_GEs_SK11   | ATMN450B |
| EMEA | Belgium        | LU.SAS0D.025 | AO532h-2Ds SNW7ST32STBE1 MC UMACsw 1*1G/250/3L2.2/5R/CBSD_bg_0.3D_GEs_NL11   | ATMN450B |
| EMEA | Ukraine        | LU.SAS0D.012 | AO532h-2Ds SNW7ST32RUSTUK1 MC UMACsw 1*1G/250/3L2.2/5R/CBSD_bg_0.3D_GEs_RU61 | ATMN450B |
| EMEA | Russia         | LU.SAS0D.011 | AO532h-2Ds SNW7ST32RUSTRU1 MC UMACsw 1*1G/250/3L2.2/5R/CBSD_bg_0.3D_GEs_RU62 | ATMN450B |
| EMEA | Russia         | LU.SAS0D.010 | AO532h-2Ds SNW7ST32RUSTRU1 MC UMACsw 1*1G/250/3L2.2/5R/CBSD_bg_0.3D_GEs_RU61 | ATMN450B |
| EMEA | UK             | LU.SAS0B.099 | AO532h-2Bs AOXPSTGB1 MC UMACsw 1*1G/160/6L2.2/5R/CBSD_bg_0.3D_GEs_EN12       | ATMN450B |
| EMEA | Denmark        | LU.SAS0B.098 | AO532h-2Bs AOXPSTDK1 MC UMACsw 1*1G/160/6L2.2/5R/CBSD_bg_0.3D_GEs_NO12       | ATMN450B |
| EMEA | Poland         | LU.SAS0B.097 | AO532h-2Bs AOXPSTPL1 MC UMACsw 1*1G/160/6L2.2/5R/CBSD_bg_0.3D_GEs_PL11       | ATMN450B |
| EMEA | Italy          | LU.SAS0B.096 | AO532h-2Bs AOXPSTIT1 MC UMACsw 1*1G/160/6L2.2/5R/CBSD_bg_0.3D_GEs_IT12       | ATMN450B |
| EMEA | Middle East    | LU.SAS0B.095 | AO532h-2Bs EM AOXPSTME4 MC UMACsw 1*1G/160/6L2.2/5R/CBSD_bg_0.3D_GEs_EN12    | ATMN450B |
| EMEA | Greece         | LU.SAS0B.094 | AO532h-2Bs AOXPSTGR1 MC UMACsw 1*1G/160/6L2.2/5R/CBSD_bg_0.3D_GEs_EL32       | ATMN450B |
| EMEA | Middle East    | LU.SAS0B.093 | AO532h-2Bs EM AOXPSTME9 MC UMACsw 1*1G/160/6L2.2/5R/CBSD_bg_0.3D_GEs_FR22    | ATMN450B |
| EMEA | Middle East    | LU.SAS0B.092 | AO532h-2Bs EM AOXPSTME2 MC UMACsw 1*1G/160/6L2.2/5R/CBSD_bg_0.3D_GEs_AR22    | ATMN450B |
| EMEA | Eastern Europe | LU.SAS0B.091 | AO532h-2Bs AOXPSTEU7 MC UMACsw 1*1G/160/6L2.2/5R/CBSD_bg_0.3D_GEs_ENR2       | ATMN450B |
| EMEA | Hungary        | LU.SAS0B.090 | AO532h-2Bs AOXPSTHU1 MC UMACsw 1*1G/160/6L2.2/5R/CBSD_bg_0.3D_GEs_HU14       | ATMN450B |
| EMEA | Czech          | LU.SAS0B.088 | AO532h-2Bs AOXPSTCZ2 MC UMACsw 1*1G/160/6L2.2/5R/CBSD_bg_0.3D_GEs_SK14       | ATMN450B |



| RO   | Country          | Acer Part No | Description   | CPU      |
|------|------------------|--------------|---|----------|
| EMEA | Ukraine          | LU.SAS0B.089 | AO532h-2Bs AOXPSTUK1 MC UMACsw 1*1G/160/6L2.2/5R/CBSD_bg_0.3D_GEs_RU11    | ATMN450B |
| EMEA | Russia           | LU.SAS0B.087 | AO532h-2Bs AOXPSTRU1 MC UMACsw 1*1G/160/6L2.2/5R/CBSD_bg_0.3D_GEs_RU12    | ATMN450B |
| EMEA | Austria          | LU.SAS0B.086 | AO532h-2Bs AOXPSTAT1 MC UMACsw 1*1G/160/6L2.2/5R/CBSD_bg_0.3D_GEs_DE11    | ATMN450B |
| EMEA | Portugal         | LU.SAS0B.085 | AO532h-2Bs AOXPSTPT1 MC UMACsw 1*1G/160/6L2.2/5R/CBSD_bg_0.3D_GEs_PT12    | ATMN450B |
| EMEA | Eastern Europe   | LU.SAS0B.084 | AO532h-2Bs AOXPSTEU5 MC UMACsw 1*1G/160/6L2.2/5R/CBSD_bg_0.3D_GEs_PL14    | ATMN450B |
| EMEA | Eastern Europe   | LU.SAS0B.083 | AO532h-2Bs AOXPSTEU4 MC UMACsw 1*1G/160/6L2.2/5R/CBSD_bg_0.3D_GEs_FI13    | ATMN450B |
| EMEA | Turkey           | LU.SAS0B.082 | AO532h-2Bs EM AOXPSTTR1 MC UMACsw 1*1G/160/6L2.2/5R/CBSD_bg_0.3D_GEs_TR33 | ATMN450B |
| EMEA | Denmark          | LU.SAS0B.081 | AO532h-2Bs AOXPSTDK2 MC UMACsw 1*1G/160/6L2.2/5R/CBSD_bg_0.3D_GEs_ENS1    | ATMN450B |
| EMEA | Russia           | LU.SAS0B.080 | AO532h-2Bs AOXPSTRU1 MC UMACsw 1*1G/160/6L2.2/5R/CBSD_bg_0.3D_GEs_RU14    | ATMN450B |
| EMEA | Poland           | LU.SAS0B.079 | AO532h-2Bs AOXPSTPL1 MC UMACsw 1*1G/160/6L2.2/5R/CBSD_bg_0.3D_GEs_PL12    | ATMN450B |
| EMEA | Switzerland      | LU.SAS0B.078 | AO532h-2Bs AOXPSTCH1 MC UMACsw 1*1G/160/6L2.2/5R/CBSD_bg_0.3D_GEs_IT43    | ATMN450B |
| EMEA | Israel           | LU.SAS0B.077 | AO532h-2Bs AOXPSTIL1 MC UMACsw 1*1G/160/6L2.2/5R/CBSD_bg_0.3D_GEs_HE13    | ATMN450B |
| EMEA | Latvia           | LU.SAS0B.075 | AO532h-2Bs AOXPSTLV1 MC UMACsw 1*1G/160/6L2.2/5R/CBSD_bg_0.3D_GEs_RU21    | ATMN450B |
| EMEA | Serbia/Macedonia | LU.SAS0B.074 | AO532h-2Bs EM AOXPSTCS1 MC UMACsw 1*1G/160/6L2.2/5R/CBSD_bg_0.3D_GEs_SL11 | ATMN450B |
| EMEA | France           | LU.SAS0B.073 | AO532h-2Bs AOXPSTFR1 MC UMACsw 1*1G/160/6L2.2/5R/CBSD_bg_0.3D_GEs_FR22    | ATMN450B |
| EMEA | South Africa     | LU.SAS0B.072 | AO532h-2Bs EM AOXPSTZA2 MC UMACsw 1*1G/160/6L2.2/5R/CBSD_bg_0.3D_GEs_EN12 | ATMN450B |
| EMEA | Norway           | LU.SAS0B.071 | AO532h-2Bs AOXPSTNO1 MC UMACsw 1*1G/160/6L2.2/5R/CBSD_bg_0.3D_GEs_NO12    | ATMN450B |
| EMEA | Middle East      | LU.SAS0B.070 | AO532h-2Bs EM AOXPSTME3 MC UMACsw 1*1G/160/6L2.2/5R/CBSD_bg_0.3D_GEs_FR22 | ATMN450B |
| EMEA | Cyprus           | LU.SAS0B.069 | AO532h-2Bs AOXPSTCY1 MC UMACsw 1*1G/160/6L2.2/5R/CBSD_bg_0.3D_GEs_EN11    | ATMN450B |
| EMEA | Switzerland      | LU.SAS0B.068 | AO532h-2Bs AOXPSTCH1 MC UMACsw 1*1G/160/6L2.2/5R/CBSD_bg_0.3D_GEs_IT42    | ATMN450B |
| EMEA | Germany          | LU.SAS0B.067 | AO532h-2Bs AOXPSTDE1 MC UMACsw 1*1G/160/6L2.2/5R/CBSD_bg_0.3D_GEs_DE12    | ATMN450B |
| EMEA | Spain            | LU.SAS0B.066 | AO532h-2Bs AOXPSTES1 MC UMACsw 1*1G/160/6L2.2/5R/CBSD_bg_0.3D_GEs_ES22    | ATMN450B |
| EMEA | Middle East      | LU.SAS0B.065 | AO532h-2Bs EM AOXPSTME2 MC UMACsw 1*1G/160/6L2.2/5R/CBSD_bg_0.3D_GEs_EN12 | ATMN450B |
| EMEA | Eastern Europe   | LU.SAS0B.064 | AO532h-2Bs AOXPSTEU3 MC UMACsw 1*1G/160/6L2.2/5R/CBSD_bg_0.3D_GEs_RU24    | ATMN450B |
| EMEA | Algeria          | LU.SAS0B.063 | AO532h-2Bs EM AOXPSTDZ1 MC UMACsw 1*1G/160/6L2.2/5R/CBSD_bg_0.3D_GEs_ES81 | ATMN450B |
| EMEA | South Africa     | LU.SAS0B.062 | AO532h-2Bs EM AOXPSTZA1 MC UMACsw 1*1G/160/6L2.2/5R/CBSD_bg_0.3D_GEs_FR22 | ATMN450B |
| EMEA | Holland          | LU.SAS0B.061 | AO532h-2Bs AOXPSTNL1 MC UMACsw 1*1G/160/6L2.2/5R/CBSD_bg_0.3D_GEs_NL12    | ATMN450B |

| RO   | Country        | Acer Part No | Description   | CPU      |
|------|----------------|--------------|---|----------|
| EMEA | Eastern Europe | LU.SAS0B.060 | AO532h-2Bs AOXPSTEU5 MC UMACsw 1*1G/160/6L2.2/5R/CBSD_bg_0.3D_GEs_RO12    | ATMN450B |
| EMEA | Eastern Europe | LU.SAS0B.059 | AO532h-2Bs AOXPSTEU7 MC UMACsw 1*1G/160/6L2.2/5R/CBSD_bg_0.3D_GEs_SL11    | ATMN450B |
| EMEA | Middle East    | LU.SAS0B.057 | AO532h-2Bs EM AOXPSTME2 MC UMACsw 1*1G/160/6L2.2/5R/CBSD_bg_0.3D_GEs_AR12 | ATMN450B |
| EMEA | Eastern Europe | LU.SAS0B.058 | AO532h-2Bs AOXPSTEU7 MC UMACsw 1*1G/160/6L2.2/5R/CBSD_bg_0.3D_GEs_EN11    | ATMN450B |
| EMEA | Belgium        | LU.SAS0B.056 | AO532h-2Bs AOXPSTBE1 MC UMACsw 1*1G/160/6L2.2/5R/CBSD_bg_0.3D_GEs_NL12    | ATMN450B |
| EMEA | Middle East    | LU.SAS0B.055 | AO532h-2Bs EM AOXPSTME6 MC UMACsw 1*1G/160/6L2.2/5R/CBSD_bg_0.3D_GEs_EN12 | ATMN450B |
| EMEA | Luxembourg     | LU.SAS0B.054 | AO532h-2Bs AOXPSTLU3 MC UMACsw 1*1G/160/6L2.2/5R/CBSD_bg_0.3D_GEs_IT41    | ATMN450B |
| EMEA | Finland        | LU.SAS0B.053 | AO532h-2Bs AOXPSTFI2 MC UMACsw 1*1G/160/6L2.2/5R/CBSD_bg_0.3D_GEs_FI11    | ATMN450B |
| EMEA | Sweden         | LU.SAS0B.052 | AO532h-2Bs AOXPSTSE1 MC UMACsw 1*1G/160/6L2.2/5R/CBSD_bg_0.3D_GEs_FI13    | ATMN450B |
| EMEA | Russia         | LU.SAS0B.051 | AO532h-2Bs AOXPSTRU1 MC UMACsw 1*1G/160/6L2.2/5R/CBSD_bg_0.3D_GEs_RU13    | ATMN450B |
| EMEA | UK             | LU.SAS0B.050 | AO532h-2Bs AOXPSTGB1 MC UMACsw 1*1G/160/3L2.2/5R/CBSD_bg_0.3D_GEs_EN12    | ATMN450B |
| EMEA | Denmark        | LU.SAS0B.049 | AO532h-2Bs AOXPSTDK1 MC UMACsw 1*1G/160/3L2.2/5R/CBSD_bg_0.3D_GEs_NO12    | ATMN450B |
| EMEA | Poland         | LU.SAS0B.048 | AO532h-2Bs AOXPSTPL1 MC UMACsw 1*1G/160/3L2.2/5R/CBSD_bg_0.3D_GEs_PL11    | ATMN450B |
| EMEA | Italy          | LU.SAS0B.047 | AO532h-2Bs AOXPSTIT1 MC UMACsw 1*1G/160/3L2.2/5R/CBSD_bg_0.3D_GEs_IT12    | ATMN450B |
| EMEA | Middle East    | LU.SAS0B.046 | AO532h-2Bs EM AOXPSTME4 MC UMACsw 1*1G/160/3L2.2/5R/CBSD_bg_0.3D_GEs_EN12 | ATMN450B |
| EMEA | Greece         | LU.SAS0B.045 | AO532h-2Bs AOXPSTGR1 MC UMACsw 1*1G/160/3L2.2/5R/CBSD_bg_0.3D_GEs_EL32    | ATMN450B |
| EMEA | Middle East    | LU.SAS0B.044 | AO532h-2Bs EM AOXPSTME9 MC UMACsw 1*1G/160/3L2.2/5R/CBSD_bg_0.3D_GEs_FR22 | ATMN450B |
| EMEA | Middle East    | LU.SAS0B.043 | AO532h-2Bs EM AOXPSTME2 MC UMACsw 1*1G/160/3L2.2/5R/CBSD_bg_0.3D_GEs_AR22 | ATMN450B |
| EMEA | Eastern Europe | LU.SAS0B.042 | AO532h-2Bs AOXPSTEU7 MC UMACsw 1*1G/160/3L2.2/5R/CBSD_bg_0.3D_GEs_ENR2    | ATMN450B |
| EMEA | Hungary        | LU.SAS0B.041 | AO532h-2Bs AOXPSTHU1 MC UMACsw 1*1G/160/3L2.2/5R/CBSD_bg_0.3D_GEs_HU14    | ATMN450B |
| EMEA | Ukraine        | LU.SAS0B.040 | AO532h-2Bs AOXPSTUK1 MC UMACsw 1*1G/160/3L2.2/5R/CBSD_bg_0.3D_GEs_RU11    | ATMN450B |
| EMEA | Czech          | LU.SAS0B.039 | AO532h-2Bs AOXPSTCZ2 MC UMACsw 1*1G/160/3L2.2/5R/CBSD_bg_0.3D_GEs_SK14    | ATMN450B |
| EMEA | Russia         | LU.SAS0B.038 | AO532h-2Bs AOXPSTRU1 MC UMACsw 1*1G/160/3L2.2/5R/CBSD_bg_0.3D_GEs_RU12    | ATMN450B |
| EMEA | Austria        | LU.SAS0B.037 | AO532h-2Bs AOXPSTAT1 MC UMACsw 1*1G/160/3L2.2/5R/CBSD_bg_0.3D_GEs_DE11    | ATMN450B |
| EMEA | Portugal       | LU.SAS0B.036 | AO532h-2Bs AOXPSTPT1 MC UMACsw 1*1G/160/3L2.2/5R/CBSD_bg_0.3D_GEs_PT12    | ATMN450B |
| EMEA | Eastern Europe | LU.SAS0B.035 | AO532h-2Bs AOXPSTEU5 MC UMACsw 1*1G/160/3L2.2/5R/CBSD_bg_0.3D_GEs_PL14    | ATMN450B |
| EMEA | Eastern Europe | LU.SAS0B.034 | AO532h-2Bs AOXPSTEU4 MC UMACsw 1*1G/160/3L2.2/5R/CBSD_bg_0.3D_GEs_FI13    | ATMN450B |

| RO   | Country              | Acer Part No | Description  | CPU      |
|------|----------------------|--------------|--|----------|
| EMEA | Turkey               | LU.SAS0B.033 | AO532h-2Bs EM AOXPHSTTR1 MC UMACsw 1*1G/160/3L2.2/5R/CBSD_bg_0.3D_GEs_TR33 | ATMN450B |
| EMEA | Denmark              | LU.SAS0B.032 | AO532h-2Bs AOXPHSTDK2 MC UMACsw 1*1G/160/3L2.2/5R/CBSD_bg_0.3D_GEs_ENS1    | ATMN450B |
| EMEA | Russia               | LU.SAS0B.031 | AO532h-2Bs AOXPHSTRU1 MC UMACsw 1*1G/160/3L2.2/5R/CBSD_bg_0.3D_GEs_RU14    | ATMN450B |
| EMEA | Poland               | LU.SAS0B.030 | AO532h-2Bs AOXPHSTPL1 MC UMACsw 1*1G/160/3L2.2/5R/CBSD_bg_0.3D_GEs_PL12    | ATMN450B |
| EMEA | Switzerland          | LU.SAS0B.029 | AO532h-2Bs AOXPHSTCH1 MC UMACsw 1*1G/160/3L2.2/5R/CBSD_bg_0.3D_GEs_IT43    | ATMN450B |
| EMEA | Israel               | LU.SAS0B.028 | AO532h-2Bs AOXPHSTIL1 MC UMACsw 1*1G/160/3L2.2/5R/CBSD_bg_0.3D_GEs_HE13    | ATMN450B |
| EMEA | Latvia               | LU.SAS0B.026 | AO532h-2Bs AOXPHSTLV1 MC UMACsw 1*1G/160/3L2.2/5R/CBSD_bg_0.3D_GEs_RU21    | ATMN450B |
| EMEA | Serbia/<br>Macedonia | LU.SAS0B.025 | AO532h-2Bs EM AOXPHSTCS1 MC UMACsw 1*1G/160/3L2.2/5R/CBSD_bg_0.3D_GEs_SL11 | ATMN450B |
| EMEA | Eastern<br>Europe    | LU.SAS0B.024 | AO532h-2Bs AOXPHSTEU5 MC UMACsw 1*1G/160/3L2.2/5R/CBSD_bg_0.3D_GEs_RO12    | ATMN450B |
| EMEA | France               | LU.SAS0B.023 | AO532h-2Bs AOXPHSTFR1 MC UMACsw 1*1G/160/3L2.2/5R/CBSD_bg_0.3D_GEs_FR22    | ATMN450B |
| EMEA | South Africa         | LU.SAS0B.022 | AO532h-2Bs EM AOXPHSTZA2 MC UMACsw 1*1G/160/3L2.2/5R/CBSD_bg_0.3D_GEs_EN12 | ATMN450B |
| EMEA | Norway               | LU.SAS0B.021 | AO532h-2Bs AOXPHSTNO1 MC UMACsw 1*1G/160/3L2.2/5R/CBSD_bg_0.3D_GEs_NO12    | ATMN450B |
| EMEA | Middle East          | LU.SAS0B.020 | AO532h-2Bs EM AOXPHSTME3 MC UMACsw 1*1G/160/3L2.2/5R/CBSD_bg_0.3D_GEs_FR22 | ATMN450B |
| EMEA | Cyprus               | LU.SAS0B.019 | AO532h-2Bs AOXPHSTCY1 MC UMACsw 1*1G/160/3L2.2/5R/CBSD_bg_0.3D_GEs_EN11    | ATMN450B |
| EMEA | Switzerland          | LU.SAS0B.018 | AO532h-2Bs AOXPHSTCH1 MC UMACsw 1*1G/160/3L2.2/5R/CBSD_bg_0.3D_GEs_IT42    | ATMN450B |
| EMEA | Germany              | LU.SAS0B.017 | AO532h-2Bs AOXPHSTDE1 MC UMACsw 1*1G/160/3L2.2/5R/CBSD_bg_0.3D_GEs_DE12    | ATMN450B |
| EMEA | Spain                | LU.SAS0B.016 | AO532h-2Bs AOXPHSTES1 MC UMACsw 1*1G/160/3L2.2/5R/CBSD_bg_0.3D_GEs_ES22    | ATMN450B |
| EMEA | Middle East          | LU.SAS0B.015 | AO532h-2Bs EM AOXPHSTME2 MC UMACsw 1*1G/160/3L2.2/5R/CBSD_bg_0.3D_GEs_EN12 | ATMN450B |
| EMEA | Eastern<br>Europe    | LU.SAS0B.014 | AO532h-2Bs AOXPHSTEU3 MC UMACsw 1*1G/160/3L2.2/5R/CBSD_bg_0.3D_GEs_RU24    | ATMN450B |
| EMEA | Algeria              | LU.SAS0B.013 | AO532h-2Bs EM AOXPHSTDZ1 MC UMACsw 1*1G/160/3L2.2/5R/CBSD_bg_0.3D_GEs_ES81 | ATMN450B |
| EMEA | South Africa         | LU.SAS0B.012 | AO532h-2Bs EM AOXPHSTZA1 MC UMACsw 1*1G/160/3L2.2/5R/CBSD_bg_0.3D_GEs_FR22 | ATMN450B |
| EMEA | Holland              | LU.SAS0B.011 | AO532h-2Bs AOXPHSTNL1 MC UMACsw 1*1G/160/3L2.2/5R/CBSD_bg_0.3D_GEs_NL12    | ATMN450B |
| EMEA | Eastern<br>Europe    | LU.SAS0B.009 | AO532h-2Bs AOXPHSTEU7 MC UMACsw 1*1G/160/3L2.2/5R/CBSD_bg_0.3D_GEs_EN11    | ATMN450B |
| EMEA | Eastern<br>Europe    | LU.SAS0B.010 | AO532h-2Bs AOXPHSTEU7 MC UMACsw 1*1G/160/3L2.2/5R/CBSD_bg_0.3D_GEs_SL11    | ATMN450B |
| EMEA | Middle East          | LU.SAS0B.008 | AO532h-2Bs EM AOXPHSTME2 MC UMACsw 1*1G/160/3L2.2/5R/CBSD_bg_0.3D_GEs_AR12 | ATMN450B |
| EMEA | Belgium              | LU.SAS0B.007 | AO532h-2Bs AOXPHSTBE1 MC UMACsw 1*1G/160/3L2.2/5R/CBSD_bg_0.3D_GEs_NL12    | ATMN450B |
| EMEA | Middle East          | LU.SAS0B.006 | AO532h-2Bs EM AOXPHSTME6 MC UMACsw 1*1G/160/3L2.2/5R/CBSD_bg_0.3D_GEs_EN12 | ATMN450B |

| RO   | Country              | Acer Part No | Description  | CPU      |
|------|----------------------|--------------|--|----------|
| EMEA | Luxembourg           | LU.SAS0B.005 | AO532h-2Bs AOXPSTLU3 MC UMACsw 1*1G/160/3L2.2/5R/CBSD_bg_0.3D_GEs_IT41                       | ATMN450B |
| EMEA | Finland              | LU.SAS0B.004 | AO532h-2Bs AOXPSTFI2 MC UMACsw 1*1G/160/3L2.2/5R/CBSD_bg_0.3D_GEs_FI11                       | ATMN450B |
| EMEA | Sweden               | LU.SAS0B.003 | AO532h-2Bs AOXPSTSE1 MC UMACsw 1*1G/160/3L2.2/5R/CBSD_bg_0.3D_GEs_FI13                       | ATMN450B |
| EMEA | Russia               | LU.SAS0B.002 | AO532h-2Bs AOXPSTRU1 MC UMACsw 1*1G/160/3L2.2/5R/CBSD_bg_0.3D_GEs_RU13                       | ATMN450B |
| EMEA | Germany              | LU.SAS0D.009 | AO532h-2Ds SNW7ST32STDE1 MC UMACsw 1*1G/250/BT/6L2.8/5R/bgn_0.3D_BAG_GEs_DE11                | ATMN450B |
| EMEA | Italy                | LU.SAS0B.001 | AO532h-2Bs AOXPSTIT1 MC UMACsw 1*1G/160/3L2.2/5R/CB_bg_0.3D_GEs_IT12                         | ATMN450B |
| AAP  | Japan                | LU.SAS0D.008 | AO532h-2Ds SNW7ST32SJP1 MC UMACsw 1*1G/250/BT/6L2.8/5R/bgn_0.3D_BAG_GEs_JA11_W126            | ATMN450B |
| AAP  | Japan                | LU.SAS0D.007 | AO532h-2Ds SNW7ST32SPJP1 MC UMACsw 1*1G/250/BT/3L2.2/5R/bgn_0.3D_BAG_GEs_JA11_W123F          | ATMN450B |
| AAP  | Japan                | LU.SAS0D.006 | AO532h-2Ds SNW7ST32SJP1 MC UMACsw 1*1G/250/BT/3L2.2/5R/bgn_0.3D_BAG_GEs_JA11_W123            | ATMN450B |
| AAP  | Malaysia             | LU.SAS0D.005 | AO532h-2Ds EM SNW7ST32EMSTMY1 MC UMACsw 1*1G/250/BT/6L2.2/5R/CB_bg_0.3D_BAG_GEs_ES61         | ATMN450B |
| EMEA | France               | LU.SAS0D.004 | AO532h-2Ds SNW7ST32STFR1 MC UMACsw 1*1G/250/BT/6L2.2/5R/CB_bgn_0.3D_GEs_FR21                 | ATMN450B |
| EMEA | France               | LU.SAS0D.003 | AO532h-2Ds SNW7ST32STFR1 MC UMACsw 1*1G/160/6L2.2/5R/CB_bgn_0.3D_GEs_FR21                    | ATMN450B |
| EMEA | Italy                | LU.SAS0D.002 | AO532h-2Ds SNW7ST32STIT1 MC UMACsw 1*1G/250/BT/6L2.8/5R/CB_bg_0.3D_GEs_IT11                  | ATMN450B |
| EMEA | Italy                | LU.SAS0D.001 | AO532h-2Ds SNW7ST32STIT1 MC UMACsw 1*1G/250/3L2.2/5R/CB_bg_0.3D_GEs_IT11                     | ATMN450B |
| AAP  | Vietnam              | LU.SAM0D.004 | AO532h-2DGb EM SNW7ST32EMSTVN1 MC UMAGCbk 1*1G/160/BT/3L2.2/5R/CB_bgn_0.3D_E77W_BAG_GEb_ES61 | ATMN450B |
| AAP  | Vietnam              | LU.SAM0B.001 | AO532h-2DGb EM AOXPSTVN1 MC UMAGCbk 1*1G/160/BT/3L2.2/5R/CB_bgn_0.3D_E77W_BAG_GEb_EN12       | ATMN450B |
| AAP  | Philippines          | LU.SAM0D.003 | AO532h-2DGb EM SNW7ST32EMSTPH1 MC UMAGCbk 1*1G/250/BT/6L2.8/5R/CB_bgn_0.3D_E77W_BAG_GEb_ES61 | ATMN450B |
| EMEA | Denmark              | LU.SAM0D.002 | AO532h-2DGb SNW7ST32STDK2 MC UMAGCbk 1*1G/250/BT/6L2.2/5R/CBSD_bgn_0.3D_E77W_GEb_ENS1        | ATMN450B |
| EMEA | UK                   | LU.SAM0D.001 | AO532h-2DGb SNW7ST32STGB1 MC UMAGCbk 1*1G/160/6L2.2/5R/CB_bg_0.3D_E77W_GEb_EN11              | ATMN450B |
| EMEA | Denmark              | LU.SAR0D.042 | AO532h-2DGr SNW7ST32STDK2 MC UMAGCrk 1*1G/250/BT/6L2.2/5R/CBSD_bgn_0.3D_E77W_GEr_ENS1        | ATMN450B |
| EMEA | South Africa         | LU.SAR0D.009 | AO532h-2DGr SNW7ST32EMSTZA2 MC UMAGCrk 1*1G/250/3L2.2/5R/CBSD_bg_0.3D_E77W_GEr_ES61          | ATMN450B |
| EMEA | Serbia/<br>Macedonia | LU.SAR0D.013 | AO532h-2DGr SNW7ST32EMSTCS1 MC UMAGCrk 1*1G/250/3L2.2/5R/CBSD_bg_0.3D_E77W_GEr_SL11          | ATMN450B |
| EMEA | Turkey               | LU.SAR0D.006 | AO532h-2DGr SNW7ST32EMSTR1 MC UMAGCrk 1*1G/250/3L2.2/5R/CBSD_bg_0.3D_E77W_GEr_TR31           | ATMN450B |

| RO   | Country      | Acer Part No | Description  | CPU      |
|------|--------------|--------------|--|----------|
| EMEA | Middle East  | LU.SAR0D.011 | AO532h-2DGr SNW7ST32EMSTME6 MC UMAGCrk 1*1G/250/3L2.2/5R/ CBSD_bg_0.3D_E77W_GEr_ES61 | ATMN450B |
| EMEA | Middle East  | LU.SAR0D.012 | AO532h-2DGr SNW7ST32EMSTME4 MC UMAGCrk 1*1G/250/3L2.2/5R/ CBSD_bg_0.3D_E77W_GEr_ES61 | ATMN450B |
| EMEA | South Africa | LU.SAR0D.008 | AO532h-2DGr SNW7ST32EMSTZA1 MC UMAGCrk 1*1G/250/3L2.2/5R/ CBSD_bg_0.3D_E77W_GEr_ES81 | ATMN450B |
| EMEA | Middle East  | LU.SAR0D.007 | AO532h-2DGr SNW7ST32EMSTME3 MC UMAGCrk 1*1G/250/3L2.2/5R/ CBSD_bg_0.3D_E77W_GEr_ES81 | ATMN450B |
| EMEA | Middle East  | LU.SAR0D.015 | AO532h-2DGr SNW7ST32EMSTME2 MC UMAGCrk 1*1G/250/3L2.2/5R/ CBSD_bg_0.3D_E77W_GEr_ES61 | ATMN450B |
| EMEA | Middle East  | LU.SAR0D.005 | AO532h-2DGr SNW7ST32EMSTME2 MC UMAGCrk 1*1G/250/3L2.2/5R/ CBSD_bg_0.3D_E77W_GEr_AR21 | ATMN450B |
| EMEA | Middle East  | LU.SAR0D.004 | AO532h-2DGr SNW7ST32EMSTME2 MC UMAGCrk 1*1G/250/3L2.2/5R/ CBSD_bg_0.3D_E77W_GEr_AR11 | ATMN450B |
| EMEA | Middle East  | LU.SAR0D.014 | AO532h-2DGr SNW7ST32EMSTME9 MC UMAGCrk 1*1G/250/3L2.2/5R/ CBSD_bg_0.3D_E77W_GEr_ES81 | ATMN450B |
| EMEA | Algeria      | LU.SAR0D.010 | AO532h-2DGr SNW7ST32EMSTDZ1 MC UMAGCrk 1*1G/250/3L2.2/5R/ CBSD_bg_0.3D_E77W_GEr_ES81 | ATMN450B |
| EMEA | Poland       | LU.SAR0D.040 | AO532h-2DGr SNW7ST32STPL1 MC UMAGCrk 1*1G/250/3L2.2/5R/CBSD_bg_0.3D_E77W_GEr_PL11    | ATMN450B |
| EMEA | Israel       | LU.SAR0D.039 | AO532h-2DGr SNW7ST32STIL1 MC UMAGCrk 1*1G/250/3L2.2/5R/CBSD_bg_0.3D_E77W_GEr_HE11    | ATMN450B |
| EMEA | Greece       | LU.SAR0D.038 | AO532h-2DGr SNW7ST32STGR1 MC UMAGCrk 1*1G/250/3L2.2/5R/ CBSD_bg_0.3D_E77W_GEr_EL31   | ATMN450B |
| EMEA | Portugal     | LU.SAR0D.037 | AO532h-2DGr SNW7ST32STPT1 MC UMAGCrk 1*1G/250/3L2.2/5R/CBSD_bg_0.3D_E77W_GEr_PT11    | ATMN450B |
| EMEA | Luxembourg   | LU.SAR0D.036 | AO532h-2DGr SNW7ST32STLU3 MC UMAGCrk 1*1G/250/3L2.2/5R/CBSD_bg_0.3D_E77W_GEr_IT41    | ATMN450B |
| EMEA | Germany      | LU.SAR0D.035 | AO532h-2DGr SNW7ST32STDE1 MC UMAGCrk 1*1G/250/3L2.2/5R/ CBSD_bg_0.3D_E77W_GEr_DE13   | ATMN450B |
| EMEA | Holland      | LU.SAR0D.034 | AO532h-2DGr SNW7ST32STNL1 MC UMAGCrk 1*1G/250/3L2.2/5R/CBSD_bg_0.3D_E77W_GEr_NL11    | ATMN450B |
| EMEA | Finland      | LU.SAR0D.033 | AO532h-2DGr SNW7ST32STFI2 MC UMAGCrk 1*1G/250/3L2.2/5R/CBSD_bg_0.3D_E77W_GEr_FI11    | ATMN450B |
| EMEA | Austria      | LU.SAR0D.032 | AO532h-2DGr SNW7ST32STAT1 MC UMAGCrk 1*1G/250/3L2.2/5R/CBSD_bg_0.3D_E77W_GEr_DE61    | ATMN450B |
| EMEA | Italy        | LU.SAR0D.031 | AO532h-2DGr SNW7ST32STIT1 MC UMAGCrk 1*1G/250/3L2.2/5R/CBSD_bg_0.3D_E77W_GEr_IT11    | ATMN450B |
| EMEA | Latvia       | LU.SAR0D.029 | AO532h-2DGr SNW7ST32STLV1 MC UMAGCrk 1*1G/250/3L2.2/5R/CBSD_bg_0.3D_E77W_GEr_RU21    | ATMN450B |
| EMEA | France       | LU.SAR0D.027 | AO532h-2DGr SNW7ST32STFR1 MC UMAGCrk 1*1G/250/3L2.2/5R/ CBSD_bg_0.3D_E77W_GEr_FR21   | ATMN450B |

| RO   | Country     | Acer Part No | Description  | CPU      |
|------|-------------|--------------|--|----------|
| EMEA | Germany     | LU.SAR0D.028 | AO532h-2DGr SNW7ST32STDE1 MC UMAGCrk<br>1*1G/250/3L2.2/5R/<br>CBSD_bg_0.3D_E77W_GEr_DE11   | ATMN450B |
| EMEA | UK          | LU.SAR0D.026 | AO532h-2DGr SNW7ST32STGB1 MC UMAGCrk<br>1*1G/250/3L2.2/5R/<br>CBSD_bg_0.3D_E77W_GEr_EN11   | ATMN450B |
| EMEA | Switzerland | LU.SAR0D.025 | AO532h-2DGr SNW7ST32STCH1 MC UMAGCrk<br>1*1G/250/3L2.2/5R/CBSD_bg_0.3D_E77W_GEr_IT41       | ATMN450B |
| EMEA | Sweden      | LU.SAR0D.024 | AO532h-2DGr SNW7ST32STSE1 MC UMAGCrk<br>1*1G/250/3L2.2/5R/CBSD_bg_0.3D_E77W_GEr_FI11       | ATMN450B |
| EMEA | Spain       | LU.SAR0D.023 | AO532h-2DGr SNW7ST32STES1 MC UMAGCrk<br>1*1G/250/3L2.2/5R/<br>CBSD_bg_0.3D_E77W_GEr_ES51   | ATMN450B |
| EMEA | Norway      | LU.SAR0D.022 | AO532h-2DGr SNW7ST32STNO1 MC UMAGCrk<br>1*1G/250/3L2.2/5R/<br>CBSD_bg_0.3D_E77W_GEr_NO11   | ATMN450B |
| EMEA | Hungary     | LU.SAR0D.021 | AO532h-2DGr SNW7ST32STHU1 MC UMAGCrk<br>1*1G/250/3L2.2/5R/<br>CBSD_bg_0.3D_E77W_GEr_HU11   | ATMN450B |
| EMEA | Denmark     | LU.SAR0D.020 | AO532h-2DGr SNW7ST32STDK1 MC UMAGCrk<br>1*1G/250/3L2.2/5R/<br>CBSD_bg_0.3D_E77W_GEr_NO11   | ATMN450B |
| EMEA | Denmark     | LU.SAR0D.019 | AO532h-2DGr SNW7ST32STDK2 MC UMAGCrk<br>1*1G/250/3L2.2/5R/<br>CBSD_bg_0.3D_E77W_GEr_ENS1   | ATMN450B |
| EMEA | Czech       | LU.SAR0D.018 | AO532h-2DGr SNW7ST32STCZ2 MC UMAGCrk<br>1*1G/250/3L2.2/5R/<br>CBSD_bg_0.3D_E77W_GEr_SK11   | ATMN450B |
| EMEA | Cyprus      | LU.SAR0D.017 | AO532h-2DGr SNW7ST32STCY1 MC UMAGCrk<br>1*1G/250/3L2.2/5R/<br>CBSD_bg_0.3D_E77W_GEr_ES61   | ATMN450B |
| EMEA | Belgium     | LU.SAR0D.016 | AO532h-2DGr SNW7ST32STBE1 MC UMAGCrk<br>1*1G/250/3L2.2/5R/CBSD_bg_0.3D_E77W_GEr_NL11       | ATMN450B |
| EMEA | Ukraine     | LU.SAR0D.003 | AO532h-2DGr SNW7ST32RUSTUK1 MC UMAGCrk<br>1*1G/250/3L2.2/5R/<br>CBSD_bg_0.3D_E77W_GEr_RU61 | ATMN450B |
| EMEA | Russia      | LU.SAR0D.001 | AO532h-2DGr SNW7ST32RUSTRU1 MC UMAGCrk<br>1*1G/250/3L2.2/5R/<br>CBSD_bg_0.3D_E77W_GEr_RU61 | ATMN450B |
| EMEA | Russia      | LU.SAR0D.002 | AO532h-2DGr SNW7ST32RUSTRU1 MC UMAGCrk<br>1*1G/250/3L2.2/5R/<br>CBSD_bg_0.3D_E77W_GEr_RU62 | ATMN450B |
| EMEA | UK          | LU.SAR0B.049 | AO532h-2BGr AOXPHSTGB1 MC UMAGCrk 1*1G/<br>160/6L2.2/5R/CBSD_bg_0.3D_E77W_GEr_EN12         | ATMN450B |
| EMEA | Denmark     | LU.SAR0B.048 | AO532h-2BGr AOXPHSTDK1 MC UMAGCrk 1*1G/<br>160/6L2.2/5R/CBSD_bg_0.3D_E77W_GEr_NO12         | ATMN450B |
| EMEA | Poland      | LU.SAR0B.047 | AO532h-2BGr AOXPHSTPL1 MC UMAGCrk 1*1G/<br>160/6L2.2/5R/CBSD_bg_0.3D_E77W_GEr_PL11         | ATMN450B |
| EMEA | Italy       | LU.SAR0B.046 | AO532h-2BGr AOXPHSTIT1 MC UMAGCrk 1*1G/160/<br>6L2.2/5R/CBSD_bg_0.3D_E77W_GEr_IT12         | ATMN450B |
| EMEA | Middle East | LU.SAR0B.045 | AO532h-2BGr EM AOXPHSTME4 MC UMAGCrk<br>1*1G/160/6L2.2/5R/<br>CBSD_bg_0.3D_E77W_GEr_EN12   | ATMN450B |
| EMEA | Greece      | LU.SAR0B.044 | AO532h-2BGr AOXPHSTGR1 MC UMAGCrk 1*1G/<br>160/6L2.2/5R/CBSD_bg_0.3D_E77W_GEr_EL32         | ATMN450B |

| RO   | Country          | Acer Part No | Description  | CPU      |
|------|------------------|--------------|--|----------|
| EMEA | Middle East      | LU.SAR0B.043 | AO532h-2BGr EM AOXPSTME9 MC UMAGCrk 1*1G/160/6L2.2/5R/CBSD_bg_0.3D_E77W_GEr_FR22 | ATMN450B |
| EMEA | Middle East      | LU.SAR0B.042 | AO532h-2BGr EM AOXPSTME2 MC UMAGCrk 1*1G/160/6L2.2/5R/CBSD_bg_0.3D_E77W_GEr_AR22 | ATMN450B |
| EMEA | Eastern Europe   | LU.SAR0B.041 | AO532h-2BGr AOXPSTEU7 MC UMAGCrk 1*1G/160/6L2.2/5R/CBSD_bg_0.3D_E77W_GEr_ENR2    | ATMN450B |
| EMEA | Hungary          | LU.SAR0B.040 | AO532h-2BGr AOXPSTHU1 MC UMAGCrk 1*1G/160/6L2.2/5R/CBSD_bg_0.3D_E77W_GEr_HU14    | ATMN450B |
| EMEA | Ukraine          | LU.SAR0B.039 | AO532h-2BGr AOXPSTUK1 MC UMAGCrk 1*1G/160/6L2.2/5R/CBSD_bg_0.3D_E77W_GEr_RU11    | ATMN450B |
| EMEA | Czech            | LU.SAR0B.038 | AO532h-2BGr AOXPSTCZ2 MC UMAGCrk 1*1G/160/6L2.2/5R/CBSD_bg_0.3D_E77W_GEr_SK14    | ATMN450B |
| EMEA | Russia           | LU.SAR0B.037 | AO532h-2BGr AOXPSTRU1 MC UMAGCrk 1*1G/160/6L2.2/5R/CBSD_bg_0.3D_E77W_GEr_RU12    | ATMN450B |
| EMEA | Austria          | LU.SAR0B.036 | AO532h-2BGr AOXPSTAT1 MC UMAGCrk 1*1G/160/6L2.2/5R/CBSD_bg_0.3D_E77W_GEr_DE11    | ATMN450B |
| EMEA | Portugal         | LU.SAR0B.035 | AO532h-2BGr AOXPSTPT1 MC UMAGCrk 1*1G/160/6L2.2/5R/CBSD_bg_0.3D_E77W_GEr_PT12    | ATMN450B |
| EMEA | Eastern Europe   | LU.SAR0B.034 | AO532h-2BGr AOXPSTEU5 MC UMAGCrk 1*1G/160/6L2.2/5R/CBSD_bg_0.3D_E77W_GEr_PL14    | ATMN450B |
| EMEA | Eastern Europe   | LU.SAR0B.033 | AO532h-2BGr AOXPSTEU4 MC UMAGCrk 1*1G/160/6L2.2/5R/CBSD_bg_0.3D_E77W_GEr_FI13    | ATMN450B |
| EMEA | Turkey           | LU.SAR0B.032 | AO532h-2BGr EM AOXPSTTR1 MC UMAGCrk 1*1G/160/6L2.2/5R/CBSD_bg_0.3D_E77W_GEr_TR33 | ATMN450B |
| EMEA | Denmark          | LU.SAR0B.031 | AO532h-2BGr AOXPSTDK2 MC UMAGCrk 1*1G/160/6L2.2/5R/CBSD_bg_0.3D_E77W_GEr_ENS1    | ATMN450B |
| EMEA | Russia           | LU.SAR0B.030 | AO532h-2BGr AOXPSTRU1 MC UMAGCrk 1*1G/160/6L2.2/5R/CBSD_bg_0.3D_E77W_GEr_RU14    | ATMN450B |
| EMEA | Poland           | LU.SAR0B.029 | AO532h-2BGr AOXPSTPL1 MC UMAGCrk 1*1G/160/6L2.2/5R/CBSD_bg_0.3D_E77W_GEr_PL12    | ATMN450B |
| EMEA | Switzerland      | LU.SAR0B.028 | AO532h-2BGr AOXPSTCH1 MC UMAGCrk 1*1G/160/6L2.2/5R/CBSD_bg_0.3D_E77W_GEr_IT43    | ATMN450B |
| EMEA | Israel           | LU.SAR0B.027 | AO532h-2BGr AOXPSTIL1 MC UMAGCrk 1*1G/160/6L2.2/5R/CBSD_bg_0.3D_E77W_GEr_HE13    | ATMN450B |
| EMEA | Latvia           | LU.SAR0B.025 | AO532h-2BGr AOXPSTLV1 MC UMAGCrk 1*1G/160/6L2.2/5R/CBSD_bg_0.3D_E77W_GEr_RU21    | ATMN450B |
| EMEA | Serbia/Macedonia | LU.SAR0B.024 | AO532h-2BGr EM AOXPSTCS1 MC UMAGCrk 1*1G/160/6L2.2/5R/CBSD_bg_0.3D_E77W_GEr_SL11 | ATMN450B |
| EMEA | France           | LU.SAR0B.023 | AO532h-2BGr AOXPSTFR1 MC UMAGCrk 1*1G/160/6L2.2/5R/CBSD_bg_0.3D_E77W_GEr_FR22    | ATMN450B |
| EMEA | South Africa     | LU.SAR0B.022 | AO532h-2BGr EM AOXPSTZA2 MC UMAGCrk 1*1G/160/6L2.2/5R/CBSD_bg_0.3D_E77W_GEr_EN12 | ATMN450B |
| EMEA | Norway           | LU.SAR0B.021 | AO532h-2BGr AOXPSTNO1 MC UMAGCrk 1*1G/160/6L2.2/5R/CBSD_bg_0.3D_E77W_GEr_NO12    | ATMN450B |
| EMEA | Middle East      | LU.SAR0B.020 | AO532h-2BGr EM AOXPSTME3 MC UMAGCrk 1*1G/160/6L2.2/5R/CBSD_bg_0.3D_E77W_GEr_FR22 | ATMN450B |
| EMEA | Cyprus           | LU.SAR0B.019 | AO532h-2BGr AOXPSTCY1 MC UMAGCrk 1*1G/160/6L2.2/5R/CBSD_bg_0.3D_E77W_GEr_EN11    | ATMN450B |
| EMEA | Switzerland      | LU.SAR0B.018 | AO532h-2BGr AOXPSTCH1 MC UMAGCrk 1*1G/160/6L2.2/5R/CBSD_bg_0.3D_E77W_GEr_IT42    | ATMN450B |
| EMEA | Germany          | LU.SAR0B.017 | AO532h-2BGr AOXPSTDE1 MC UMAGCrk 1*1G/160/6L2.2/5R/CBSD_bg_0.3D_E77W_GEr_DE12    | ATMN450B |

| RO   | Country        | Acer Part No | Description  | CPU      |
|------|----------------|--------------|--|----------|
| EMEA | Spain          | LU.SAR0B.016 | AO532h-2BGr AOXPHESTES1 MC UMAGCrk 1*1G/<br>160/6L2.2/5R/CBSD_bg_0.3D_E77W_GEr_ES22          | ATMN450B |
| EMEA | Middle East    | LU.SAR0B.015 | AO532h-2BGr EM AOXPHESTME2 MC UMAGCrk<br>1*1G/160/6L2.2/5R/<br>CBSD_bg_0.3D_E77W_GEr_EN12    | ATMN450B |
| EMEA | Eastern Europe | LU.SAR0B.014 | AO532h-2BGr AOXPHESTEU3 MC UMAGCrk 1*1G/<br>160/6L2.2/5R/CBSD_bg_0.3D_E77W_GEr_RU24          | ATMN450B |
| EMEA | Algeria        | LU.SAR0B.013 | AO532h-2BGr EM AOXPHESTZ1 MC UMAGCrk 1*1G/<br>160/6L2.2/5R/CBSD_bg_0.3D_E77W_GEr_ES81        | ATMN450B |
| EMEA | South Africa   | LU.SAR0B.012 | AO532h-2BGr EM AOXPHESTZA1 MC UMAGCrk 1*1G/<br>160/6L2.2/5R/CBSD_bg_0.3D_E77W_GEr_FR22       | ATMN450B |
| EMEA | Holland        | LU.SAR0B.011 | AO532h-2BGr AOXPHESTNL1 MC UMAGCrk 1*1G/<br>160/6L2.2/5R/CBSD_bg_0.3D_E77W_GEr_NL12          | ATMN450B |
| EMEA | Eastern Europe | LU.SAR0B.010 | AO532h-2BGr AOXPHESTEU5 MC UMAGCrk 1*1G/<br>160/6L2.2/5R/CBSD_bg_0.3D_E77W_GEr_RO12          | ATMN450B |
| EMEA | Eastern Europe | LU.SAR0B.009 | AO532h-2BGr AOXPHESTEU7 MC UMAGCrk 1*1G/<br>160/6L2.2/5R/CBSD_bg_0.3D_E77W_GEr_SL11          | ATMN450B |
| EMEA | Eastern Europe | LU.SAR0B.008 | AO532h-2BGr AOXPHESTEU7 MC UMAGCrk 1*1G/<br>160/6L2.2/5R/CBSD_bg_0.3D_E77W_GEr_EN11          | ATMN450B |
| EMEA | Middle East    | LU.SAR0B.007 | AO532h-2BGr EM AOXPHESTME2 MC UMAGCrk<br>1*1G/160/6L2.2/5R/<br>CBSD_bg_0.3D_E77W_GEr_AR12    | ATMN450B |
| EMEA | Belgium        | LU.SAR0B.006 | AO532h-2BGr AOXPHESTBE1 MC UMAGCrk 1*1G/<br>160/6L2.2/5R/CBSD_bg_0.3D_E77W_GEr_NL12          | ATMN450B |
| EMEA | Middle East    | LU.SAR0B.005 | AO532h-2BGr EM AOXPHESTME6 MC UMAGCrk<br>1*1G/160/6L2.2/5R/<br>CBSD_bg_0.3D_E77W_GEr_EN12    | ATMN450B |
| EMEA | Luxembourg     | LU.SAR0B.004 | AO532h-2BGr AOXPHESTLU3 MC UMAGCrk 1*1G/<br>160/6L2.2/5R/CBSD_bg_0.3D_E77W_GEr_IT41          | ATMN450B |
| EMEA | Finland        | LU.SAR0B.003 | AO532h-2BGr AOXPHESTFI2 MC UMAGCrk 1*1G/160/<br>6L2.2/5R/CBSD_bg_0.3D_E77W_GEr_FI11          | ATMN450B |
| EMEA | Sweden         | LU.SAR0B.002 | AO532h-2BGr AOXPHESTSE1 MC UMAGCrk 1*1G/<br>160/6L2.2/5R/CBSD_bg_0.3D_E77W_GEr_FI13          | ATMN450B |
| EMEA | Russia         | LU.SAR0B.001 | AO532h-2BGr AOXPHESTRU1 MC UMAGCrk 1*1G/<br>160/6L2.2/5R/CBSD_bg_0.3D_E77W_GEr_RU13          | ATMN450B |
| EMEA | Denmark        | LU.SAT0D.001 | AO532h-2DGs SNW7ST32STDK2 MC UMAGCsw<br>1*1G/250/BT/6L2.2/5R/<br>CBSD_bgn_0.3D_E77W_GEs_ENS1 | ATMN450B |

| LCD            | VGA Chip | VRA M 1 | Memory 1 | Memory 2 | HDD 1(GB)   | HDD 2(GB) |
|----------------|----------|---------|----------|----------|-------------|-----------|
| NLED10.1WSVGAG | UMA      | N       | SO1GBII8 | N        | N160GB5.4KS | N         |
| NLED10.1WSVGAG | UMA      | N       | SO1GBII8 | N        | N250GB5.4KS | N         |
| NLED10.1WSVGAG | UMA      | N       | SO1GBII8 | N        | N250GB5.4KS | N         |
| NLED10.1WSVGAG | UMA      | N       | SO1GBII8 | N        | N250GB5.4KS | N         |
| NLED10.1WSVGAG | UMA      | N       | SO1GBII8 | N        | N250GB5.4KS | N         |
| NLED10.1WSVGAG | UMA      | N       | SO1GBII8 | N        | N160GB5.4KS | N         |
| NLED10.1WSVGAG | UMA      | N       | SO1GBII8 | N        | N250GB5.4KS | N         |
| NLED10.1WSVGAG | UMA      | N       | SO1GBII8 | N        | N250GB5.4KS | N         |
| NLED10.1WSVGAG | UMA      | N       | SO1GBII8 | N        | N160GB5.4KS | N         |
| NLED10.1WSVGAG | UMA      | N       | SO1GBII8 | N        | N160GB5.4KS | N         |
| NLED10.1WSVGAG | UMA      | N       | SO1GBII8 | N        | N250GB5.4KS | N         |







































| ODD | Media Processor | Extra SW1 | Card Reader     | Wireless LAN1    | Bluetooth |
|-----|-----------------|-----------|-----------------|------------------|-----------|
| N   | N               | N         | 5 in 1-Build in | 3rd WiFi BG      | BT 2.1    |
| N   | N               | McAfee    | 5 in 1-Build in | 3rd WiFi BG      | BT 2.1    |
| N   | N               | McAfee    | 5 in 1-Build in | 3rd WiFi 1x2 BGN | BT 2.1    |
| N   | N               | McAfee    | 5 in 1-Build in | 3rd WiFi 1x2 BGN | BT 2.1    |
| N   | N               | McAfee    | 5 in 1-Build in | 3rd WiFi BG      | N         |
| N   | N               | McAfee    | 5 in 1-Build in | 3rd WiFi BG      | N         |
| N   | N               | McAfee    | 5 in 1-Build in | 3rd WiFi BG      | BT 2.1    |
| N   | N               | McAfee    | 5 in 1-Build in | 3rd WiFi BG      | BT 2.1    |
| N   | N               | McAfee    | 5 in 1-Build in | 3rd WiFi BG      | N         |
| N   | N               | McAfee    | 5 in 1-Build in | 3rd WiFi BG      | N         |
| N   | N               | McAfee    | 5 in 1-Build in | 3rd WiFi BG      | N         |
| N   | N               | McAfee    | 5 in 1-Build in | 3rd WiFi BG      | N         |
| N   | N               | McAfee    | 5 in 1-Build in | 3rd WiFi BG      | BT 2.1    |
| N   | N               | McAfee    | 5 in 1-Build in | 3rd WiFi BG      | BT 2.1    |
| N   | N               | McAfee    | 5 in 1-Build in | 3rd WiFi BG      | BT 2.1    |
| N   | N               | McAfee    | 5 in 1-Build in | 3rd WiFi BG      | N         |
| N   | N               | McAfee    | 5 in 1-Build in | 3rd WiFi BG      | N         |
| N   | N               | McAfee    | 5 in 1-Build in | 3rd WiFi BG      | N         |
| N   | N               | McAfee    | 5 in 1-Build in | 3rd WiFi BG      | N         |
| N   | N               | McAfee    | 5 in 1-Build in | 3rd WiFi BG      | BT 2.1    |
| N   | N               | McAfee    | 5 in 1-Build in | 3rd WiFi BG      | BT 2.1    |
| N   | N               | McAfee    | 5 in 1-Build in | 3rd WiFi BG      | N         |
| N   | N               | McAfee    | 5 in 1-Build in | 3rd WiFi BG      | N         |
| N   | N               | McAfee    | 5 in 1-Build in | 3rd WiFi BG      | N         |
| N   | N               | McAfee    | 5 in 1-Build in | 3rd WiFi BG      | N         |
| N   | N               | McAfee    | 5 in 1-Build in | 3rd WiFi BG      | BT 2.1    |
| N   | N               | McAfee    | 5 in 1-Build in | 3rd WiFi BG      | BT 2.1    |
| N   | N               | McAfee    | 5 in 1-Build in | 3rd WiFi BG      | N         |
| N   | N               | McAfee    | 5 in 1-Build in | 3rd WiFi BG      | N         |
| N   | N               | McAfee    | 5 in 1-Build in | 3rd WiFi BG      | N         |
| N   | N               | McAfee    | 5 in 1-Build in | 3rd WiFi BG      | BT 2.1    |
| N   | N               | McAfee    | 5 in 1-Build in | 3rd WiFi BG      | BT 2.1    |
| N   | N               | McAfee    | 5 in 1-Build in | 3rd WiFi BG      | N         |
| N   | N               | McAfee    | 5 in 1-Build in | 3rd WiFi BG      | N         |
| N   | N               | McAfee    | 5 in 1-Build in | 3rd WiFi 1x2 BGN | BT 2.1    |
| N   | N               | McAfee    | 5 in 1-Build in | 3rd WiFi 1x2 BGN | BT 2.1    |
| N   | N               | McAfee    | 5 in 1-Build in | 3rd WiFi 1x2 BGN | BT 2.1    |
| N   | N               | McAfee    | 5 in 1-Build in | 3rd WiFi 1x2 BGN | BT 2.1    |
| N   | N               | McAfee    | 5 in 1-Build in | 3rd WiFi BG      | BT 2.1    |



































| ODD | Media Processor | Extra SW1 | Card Reader     | Wireless LAN1    | Bluetooth |
|-----|-----------------|-----------|-----------------|------------------|-----------|
| N   | N               | McAfee    | 5 in 1-Build in | 3rd WiFi BG      | N         |
| N   | N               | McAfee    | 5 in 1-Build in | 3rd WiFi BG      | N         |
| N   | N               | McAfee    | 5 in 1-Build in | 3rd WiFi BG      | N         |
| N   | N               | McAfee    | 5 in 1-Build in | 3rd WiFi BG      | N         |
| N   | N               | McAfee    | 5 in 1-Build in | 3rd WiFi BG      | N         |
| N   | N               | McAfee    | 5 in 1-Build in | 3rd WiFi BG      | N         |
| N   | N               | McAfee    | 5 in 1-Build in | 3rd WiFi BG      | N         |
| N   | N               | McAfee    | 5 in 1-Build in | 3rd WiFi BG      | N         |
| N   | N               | McAfee    | 5 in 1-Build in | 3rd WiFi BG      | N         |
| N   | N               | McAfee    | 5 in 1-Build in | 3rd WiFi BG      | N         |
| N   | N               | McAfee    | 5 in 1-Build in | 3rd WiFi BG      | N         |
| N   | N               | McAfee    | 5 in 1-Build in | 3rd WiFi 1x2 BGN | BT 2.1    |



# Test Compatible Components

---

This computer's compatibility is tested and verified by Acer's internal testing department. All of its system functions are tested under Windows® XP and Windows® 7 environments.

Refer to the following lists for components, adapter cards, and peripherals which have passed these tests. Regarding configuration, combination and test procedures, please refer to the NAV50 series Compatibility Test Report released by the Acer Mobile System Testing Department.

# Windows Environment Test

| Category           | Vendor  | Type            | Description   |
|--------------------|---------|-----------------|---|
| <b>A cover</b>     |         |                 |   |
|                    |         | Blue IMR        | A cover Blue IMR (LCVM+Gradation)   |
|                    |         | Red IMR         | Red IMR   |
|                    |         | Silver IMR      | A cover Silver IMR (Mat+Pattern)  |
| <b>Accessory</b>   |         |                 |   |
|                    |         | Jasper Bag      | Jasper Bag  |
| <b>Adapter</b>     |         |                 |   |
|                    | DELTA   | 40W             | Adapter DELTA 40W 19V 1.7x5.5x11 Black ADP-40 TH AA, LV5 wall-mounted, OBL LF                                     |
| <b>Audio Codec</b> |         |                 |   |
|                    | Realtek | ALC272X         | Realtek Audio Codec ALC272X   |
| <b>B cover</b>     |         |                 |   |
|                    |         | Mirror w/Camera | Mirror w/Camera   |
| <b>Battery</b>     |         |                 |   |
|                    | SANYO   | 3CELL2.2        | Battery SANYO UM-2009G Li-Ion 3S1P<br>SANYO 3 cell 2200mAh Main COMMON<br>ID:UM09G31                              |
|                    | SANYO   | 6CELL2.2        | Battery SANYO UM-2009H Li-Ion 3S2P<br>SANYO 6 cell 4400mAh Main COMMON<br>ID:UM09H31                              |
|                    | SANYO   | 6CELL2.2        | Battery SANYO UM-2009H Li-Ion 3S2P<br>SANYO 6 cell 4400mAh Main COMMON<br>ID:UM09H31                              |
|                    | SIMPLO  | 6CELL2.8        | Battery SIMPLO UM-2009H Li-Ion 3S2P<br>SAMSUNG 6 cell 5600mAh Main COMMON<br>ID:UM09H70                           |
| <b>Bluetooth</b>   |         |                 |   |
|                    | Foxconn | BT 2.1          | Foxconn Bluetooth FOX BRM 2046 BT2.1  |
| <b>Camera</b>      |         |                 |   |
|                    | Suyin   | 0.3M LDV        | Suyin Camera Rose_2G  |
| <b>Card Reader</b> |         |                 |   |
|                    |         | 5 in 1-Build in | 5 in 1-Build in MS, MS Pro, SD, SC, XD  |
| <b>CPU</b>         |         |                 |   |
|                    | INTEL   | ATMN450B        | CPU Intel Atom N450 BGA 1.66G 512K  |
| <b>HDD</b>         |         |                 |   |
|                    | HGST    | N250GB5.4KS     | HDD HGST 2.5" 5400rpm 250GB<br>HTS545025B9A300 Panther B SATA LF F/<br>W:C60F Disk imbalance criteria = 0.014g-cm |
|                    | SEAGATE | N160GB5.4KS     | HDD SEAGATE 2.5" 5400rpm 160GB<br>ST9160314AS Wyatt SATA LF F/W:0001SDM1  |
| <b>Keyboard</b>    |         |                 |   |
|                    | ACER    | NT0T            | Keyboard ACER NT0T JV01_PT Internal 10<br>Standard Black NONE Texture   |
|                    | ACER    | NT0T White      | Keyboard ACER NT0T White JV01_PT Internal<br>10 Standard White NONE Texture                                       |

| Category            | Vendor  | Type                | Description  |
|---------------------|---------|---------------------|--|
| <b>LAN</b>          |         |                     |  |
|                     | Atheros | AR8132L             | Atheros AR8132L  |
| <b>LCD</b>          |         |                     |  |
|                     | AUO     | NLED10.1WSVG<br>A   | LED LCD AUO 10.1" WSVGA None Glare<br>B101AW03 V1 LF 200nit 16ms 400:1       |
|                     | AUO     | NLED10.1WSVG<br>AG  | LED LCD AUO 10.1" WSVGA Glare<br>B101AW03 V0 2A (3G) LF 200nit 8ms 500:1     |
|                     | AUO     | NLED10.1WXGA<br>G   | LED LCD AUO 10.1" WXGA Glare B101EW02<br>V0 LF 200nit 16ms                   |
|                     | SAMSUNG | NLED10.1WSVG<br>AG  | LED LCD SAMSUNG 10.1" WSVGA Glare<br>LTN101NT02-A04 LF 200nit 16ms 400:1     |
| <b>MEM</b>          |         |                     |  |
|                     | MICRON  | SO1GBII8            | Memory MICRON SO-DIMM DDRII 800 1GB<br>MT8HTF12864HDY-800G1 LF 64*16 0.065um |
| <b>NB Chipset</b>   |         |                     |  |
|                     | INTEL   | NM10                | NB Chipset Intel CS CG82NM10   |
| <b>Software</b>     |         |                     |  |
|                     |         | McAfee              | Antivirus application McAfee   |
| <b>VGA Chip</b>     |         |                     |  |
|                     | None    | UMA                 | UMA (Intel)  |
| <b>WiFi Antenna</b> |         |                     |  |
|                     | WNC     | PIFA                | PIFA   |
| <b>Wiping Cloth</b> |         |                     |  |
|                     |         | Wiping Cloth        | Wiping Cloth Wiping Cloth BAP31-41-51<br>Wiping Cloth 15x15cm                |
| <b>Wireless LAN</b> |         |                     |  |
|                     | Foxconn | 3rd WiFi 1x2<br>BGN | Foxconn Wireless LAN Atheros HB93 1x2 BGN<br>(HM)                            |
|                     | Foxconn | 3rd WiFi BG         | Foxconn Wirelss LAN Atheros HB95 1x1 BG<br>(HM)                              |
|                     | Foxconn | 3rd WiFi BG         | Foxconn Wirelss LAN Atheros HB95 1x1 BG<br>(HM)                              |



# Online Support Information

---

This section describes online technical support services available to help you repair your Acer Systems.

If you are a distributor, dealer, ASP or TPM, please refer your technical queries to your local Acer branch office. Acer Branch Offices and Regional Business Units may access our website. However some information sources will require a user i.d. and password. These can be obtained directly from Acer CSD Taiwan.

Acer's Website offers you convenient and valuable support resources whenever you need them.

In the Technical Information section you can download information on all of Acer's Notebook, Desktop and Server models including:

- Service guides for all models
- User's manuals
- Bios updates
- Software utilities
- Spare parts lists
- TABs (Technical Announcement Bulletin)

For these purposes, we have included an Acrobat File to facilitate the problem-free downloading of our technical material.

Also contained on this website are:

- Detailed information on Acer's International Traveler's Warranty (ITW)
- Returned material authorization procedures
- An overview of all the support services we offer, accompanied by a list of telephone, fax and email contacts for all your technical queries.

We are always looking for ways to optimize and improve our services, so if you have any suggestions or comments, please do not hesitate to communicate these to us.





**Numerics**

- 3G Cover
  - Removing 43
- 3G Module
  - Removing 47
  - Replacing 99

**A**

- Antennas
  - Removing 78
  - Replacing 80

**B**

- Battery Pack
  - Removing 42
  - Replacing 102
- BIOS
  - ROM size 17
  - ROM type 17
  - vendor 17
  - Version 17
- BIOS Utility 21–29
  - Advanced 24
  - Boot 27
  - Exit 28
  - Navigating 21
  - Save and Exit 28
  - Security 24
  - System Security 28
- Bluetooth Module
  - Removing 60
  - Replacing 92
- Board Layout
  - Top View 127
- brightness
  - hotkeys 13

**C**

- Camera Board
  - Removing 73
  - Replacing 85
- Common Problems 104

**D**

- DIMM Module

- Removing 45
- Replacing 99

- Display 4
- display
  - hotkeys 13

**E**

- Euro Key 14
- External Module Disassembly
  - Flowchart 41

**F**

- Features 1
- FLASH Utility 29
- Flash Utility 29
- FRU (Field Replaceable Unit) List 135

**H**

- Hard Disk Drive Module
  - Replacing 101
- HDD Cover
  - Removing 43
- Hibernation mode
  - hotkey 13
- Hot Keys 11

**I**

- Indicators 9
- Intermittent Problems 119
- Internal Microphone Failure 111
- Internal Speaker Failure 109

**J**

- Jumper and Connector Locations 127

**K**

- Keyboard
  - Removing 52
  - Replacing 98
- Keyboard Failure 107

**L**

---

- LCD Bezel
  - Removing 72
  - Replacing 86
- LCD Cable
  - Replacing 82
- LCD Failure 107
- LCD Module
  - Removing 69
  - Replacing 87
- LCD Module Disassembly
  - Flowchart 71
- LCD Module Reassembly Procedure 80
- LCD Panel
  - Removing 74
  - Replacing 84
- Lower Covers
  - Removing 43

## M

- Main Module Reassembly Procedure 87
- Main Unit Disassembly
  - Flowchart 50
- Mainboard
  - Removing 65
  - Replacing 90
- Memory Check 104
- Memory Cover
  - Removing 43
- Microphone
  - Removing 74
  - Replacing 84
- Model Definition 146

## N

- No Display Issue 105
- Notebook Manager
  - hotkey 13

## O

- ODD Failure 113, 117
- Online Support Information 213

## P

- Panel 5
  - left 5

- PC Card 9
- POST Codes
  - Reference Tables 121
- Power Board
  - Removing 59
  - Replacing 94
- Power Button Failure 117
- Power On Failure 104

## S

- Speaker Module
  - Removing 61
  - Replacing 89
- speakers
  - hotkey 13
- System
  - Block Diagram 4

## T

- Test Compatible Components 209
- Thermal Module
  - Removing 67
- Touch Pad
  - hotkey 13
- Touch Pad Failure 108
- TouchPad FFC
  - Replacing 93
- Troubleshooting
  - Built-in KB Failure 107
  - Internal Microphone 111
  - Internal Speakers 109
  - LCD Failure 107
  - No Display 105
  - ODD 113, 117
  - Other Failures 118
  - Power Button 117
  - Power On 104
  - Touch Pad 108
  - USB 113
  - WLAN 118

## U

- Undetermined Problems 119
- Upper Cover
  - Removing 54
  - Replacing 96
- USB Board

---

Removing 63  
Replacing 91

USB Failure (Rightside) 113

utility

BIOS 21–29

## **V**

volume

hotkeys 13

## **W**

Windows 2000 Environment Test 210

Wireless Function Failure 118

WLAN Board

Replacing 92

