

Aspire one (AO751h)Series Service Guide

Service guide files and updates are available on the ACER/CSD web; for more information, please refer to <http://csd.acer.com.tw>

PRINTED IN TAIWAN

Revision History

Please refer to the table below for the updates made on this service guide.

Date	Chapter	Updates

Copyright

Copyright © 2009 by Acer Incorporated. All rights reserved. No part of this publication may be reproduced, transmitted, transcribed, stored in a retrieval system, or translated into any language or computer language, in any form or by any means, electronic, mechanical, magnetic, optical, chemical, manual or otherwise, without the prior written permission of Acer Incorporated.

Disclaimer

The information in this guide is subject to change without notice.

Acer Incorporated makes no representations or warranties, either expressed or implied, with respect to the contents hereof and specifically disclaims any warranties of merchantability or fitness for any particular purpose. Any Acer Incorporated software described in this manual is sold or licensed "as is". Should the programs prove defective following their purchase, the buyer (and not Acer Incorporated, its distributor, or its dealer) assumes the entire cost of all necessary servicing, repair, and any incidental or consequential damages resulting from any defect in the software.

Acer is a registered trademark of Acer Corporation.

Intel is a registered trademark of Intel Corporation.

Pentium and Pentium II/III are trademarks of Intel Corporation.

Other brand and product names are trademarks and/or registered trademarks of their respective holders.

Conventions

The following conventions are used in this manual:

SCREEN MESSAGES	Denotes actual messages that appear on screen.
NOTE	Gives bits and pieces of additional information related to the current topic.
WARNING	Alerts you to any damage that might result from doing or not doing specific actions.
CAUTION	Gives precautionary measures to avoid possible hardware or software problems.
IMPORTANT	Reminds you to do specific actions relevant to the accomplishment of procedures.

Preface

Before using this information and the product it supports, please read the following general information.

1. This Service Guide provides you with all technical information relating to the BASIC CONFIGURATION decided for Acer's "global" product offering. To better fit local market requirements and enhance product competitiveness, your regional office MAY have decided to extend the functionality of a machine (e.g. add-on card, modem, or extra memory capability). These LOCALIZED FEATURES will NOT be covered in this generic service guide. In such cases, please contact your regional offices or the responsible personnel/channel to provide you with further technical details.
2. Please note WHEN ORDERING FRU PARTS, that you should check the most up-to-date information available on your regional web or channel. If, for whatever reason, a part number change is made, it will not be noted in the printed Service Guide. For ACER-AUTHORIZED SERVICE PROVIDERS, your Acer office may have a DIFFERENT part number code to those given in the FRU list of this printed Service Guide. You MUST use the list provided by your regional Acer office to order FRU parts for repair and service of customer machines.

System Specifications	1
Features	1
System Block Diagram	3
Your Acer Notebook tour	4
Front View	4
Closed Front View	5
Left View	5
Right View	6
Rear and Base View	7
Indicators	8
TouchPad Basics	9
Using the Keyboard	10
Lock Keys and embedded numeric keypad	10
Windows Keys	11
Hot Keys	12
Special Keys	13
Hardware Specifications and Configurations	14
 System Utilities	 21
BIOS Setup Utility	21
Navigating the BIOS Utility	21
Information	22
Main	23
Intel	24
Security	26
Boot	29
Exit	30
BIOS Flash Utility	31
DOS Flash Utility	31
WinFlash Utility	34
Remove HDD/BIOS Password Utilities	35
Miscellaneous Utilities	37
 Machine Disassembly and Replacement	 41
Disassembly Requirements	41
Related Information	41
General Information	42
Pre-disassembly Instructions	42
Disassembly Process	42
External Module Disassembly Process	43
External Modules Disassembly Flowchart	43
Removing the Battery Pack	44
Removing the Lower Covers	45
Removing the Hard Disk Drive Module	47
Removing the DIMM Module	49
Removing the WLAN Board	50
Removing the 3G Module	52
Main Unit Disassembly Process	54
Main Unit Disassembly Flowchart	54
Removing the Keyboard	55
Removing the Hinge Covers	57
Removing the Upper Cover	58
Removing the TouchPad Bracket and Button Board	61
Removing the Card Reader Board	64

Table of Contents

Removing the CRT Board	66
Removing the LAN Board	68
Removing the LCD Module	70
Removing the Bluetooth Module	73
Removing the LED Board	75
Removing the CPU Fan	77
Removing the Speaker Module	79
Removing the Mainboard	82
Removing the RTC Battery	84
Removing the Thermal Module	85
LCD Module Disassembly Process	86
LCD Module Disassembly Flowchart	86
Removing the LCD Bezel	87
Removing the Camera Board	89
Removing the LCD Panel	90
Removing the LCD Brackets and FPC Cable	92
Removing the Antennas	95
LCD Module Reassembly Procedure	97
Replacing the Antennas	97
Replacing the LCD Cable and Brackets	99
Replacing the LCD Panel	102
Replacing the Camera Board	103
Replacing the LCD Bezel	104
Main Module Reassembly Procedure	105
Replacing the Thermal Module	105
Replacing the Mainboard	106
Replacing the Speaker Module	108
Replacing the CPU Fan	110
Replacing the LED Board	111
Replacing the Bluetooth Module	113
Replacing the LCD Module	114
Replacing the LAN Board	117
Replacing the CRT Board	119
Replacing the Card Reader Board	120
Replacing the TouchPad Bracket and Button Board	121
Replacing the Upper Cover	124
Removing the Hinge Covers	127
Removing the Keyboard	127
Reassembling External Modules	129
Removing the 3G Module	129
Replacing the WLAN Board	130
Removing the DIMM Module	132
Replacing the Hard Disk Drive Module	132
Replacing the Lower Covers	134
Replacing the Battery Pack	136

Troubleshooting

137

Common Problems	137
Power On Issue	138
No Display Issue	139
Random Loss of BIOS Settings	140
LCD Failure	141
Built-In Keyboard Failure	142
TouchPad Failure	143
Internal Speaker Failure	144

Table of Contents

Internal Microphone Failure	146
HDD Not Operating Correctly	147
USB Failure (Right up/down side)	148
Modem Failure	149
External Mouse Failure	150
Other Failures	150
Intermittent Problems	151
Undetermined Problems	151
POST Code Reference Tables	152
Each SmmDriver entry point used in 80_PORT	156
Jumper and Connector Locations	157
Top View	157
Bottom View	158
Clearing Password Check and BIOS Recovery	159
Motherboard CMOS Discharge	159
BIOS Recovery by Crisis Disk	161
FRU (Field Replaceable Unit) List	163
Aspire one Exploded Diagrams	164
Main Assembly	164
LCD Assembly	165
Aspire one FRU List	166
Screw List	172
Model Definition and Configuration	174
Aspire one Series	174
Test Compatible Components	175
Windows XP Environment Test	176
Online Support Information	189
Index	191

Table of Contents

System Specifications

Features

Below is a brief summary of the computer's many features:

Operating System

- Genuine Windows® XP Home (Service Pack 3)
- Genuine Windows Vista™

Platform

- Intel® Atom™ processor
- Mobile Intel® US15W Express Chipset

System Memory

- Single channel with one soDIMM slot.
 - The system supports DDR2 533/667/800 MHz SDRAM, however due to chipset limitations memory will only operate at 533 MHz.
 - soDIMM slot: Supports 512 MB / 1 GB soDIMMs for total system memory of up to 1 GB

Display and graphics

- 11.6" HD WXGA high-brightness (typical 200-nit) Acer CrystalBrite™ TFT LCD, 1366 x 768 pixel resolution

Storage subsystem

- 2.5" 9.5 mm 160 GB or larger hard disk drive
- Multi-in-1 card reader

Audio subsystem

- High-definition audio support
- Two built-in stereo speakers
- MS-Sound compatible
- Built-in digital microphone

Communication

- Integrated Acer Crystal Eye webcam, supporting 0.3-megapixel resolution
- WLAN: Acer InViLink™ 802.11b/g Wi-Fi CERTIFIED® network connection, supporting Acer SignalUp™ wireless technology
- LAN: 10/100 Mbps Fast Ethernet
- WPAN: Bluetooth® 2.0 or 2.1+EDR

-
- WWAN: UMTS/HSPA at 850/1900/2100 MHz and quad-band GSM/GPRS/EDGE (850/900/1800/1900 MHz) (for 3G models)

Privacy control

- Kensington lock slot

Dimensions and Weight

- 284 (W) x 198 (D) x 25.4 (H) mm (11.18 x 7.79 x 1 inches)
- 1.25 kg (2.75 lbs.) with 3-cell battery pack
- 1.35 kg (2.97 lbs.) with 6-cell battery pack

Power subsystem

- 24.4 W 2200 mAh 3-cell Li-ion battery pack
 - 4-hour battery life
- 57.7 W 5200 mAh 6-cell Li-ion battery pack
 - 8-hour battery life
- ENERGY STAR® 4.0
- 30 W adapter with power cord

Special keys and controls

- 86/87/91-key keyboard
- Touchpad pointing device with two buttons

I/O interface

- Multi-in-1 card reader
- Three USB 2.0 ports
- External display (VGA) port
- Headphone/speaker/line-out jack
- Microphone-in jack
- Ethernet (RJ-45) port
- DC-in jack for AC adapter

Environment

- Temperature:
 - Operating: 5 °C to 35 °C
 - Non-operating: -20 °C to 65 °C
- Humidity (non-condensing):
 - Operating: 20% to 80%
 - Non-operating: 20% to 80%

System Block Diagram

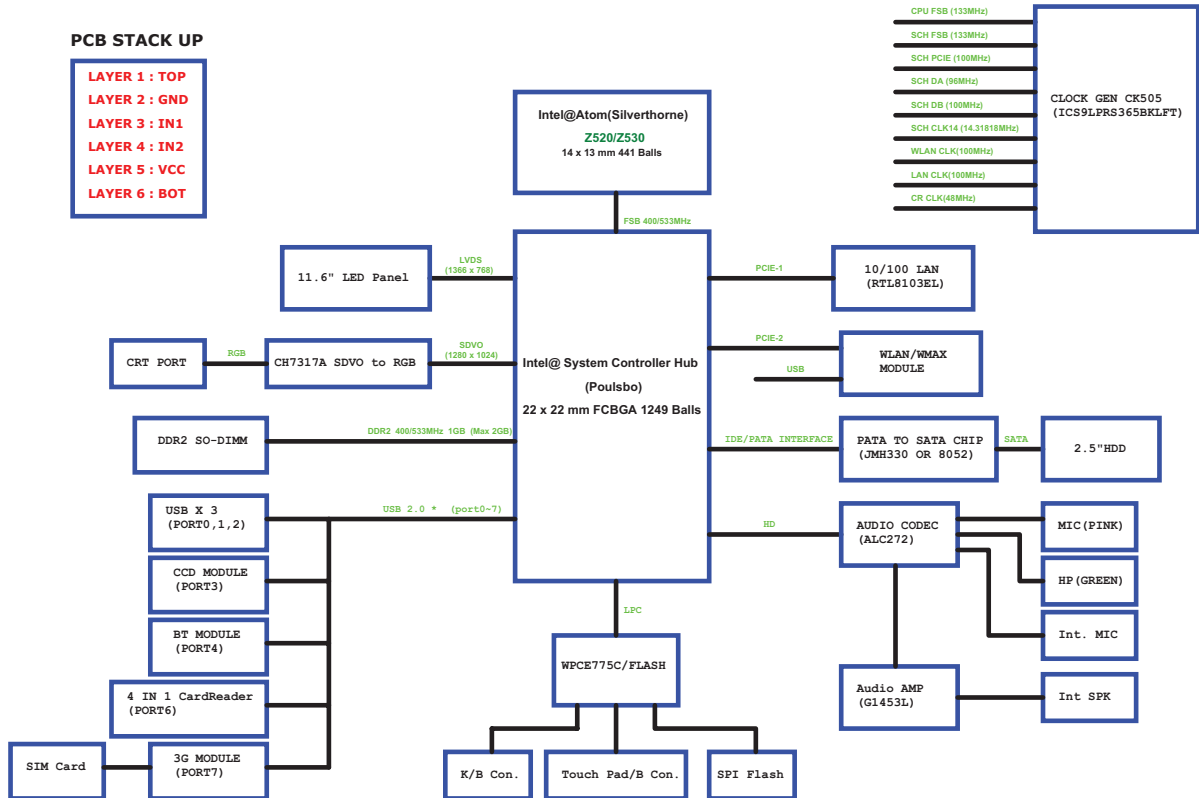





Your Acer Notebook tour

After learning about your computer features, let us show you around your new computer.

Front View





No.	Icon	Item	Description
1		Acer Crystal Eye Webcam	Web camera for video communication.
2		Microphone	Internal microphone for sound recording.
3		Display screen	Also called Liquid-Crystal Display (LCD), displays computer output.
4		Keyboard	For entering data into your computer.
5		TouchPad	Touch-sensitive pointing device which functions like a computer mouse.
6	   	Battery/ Bluetooth/3G/ Wireless LAN communication indicator	Indicates the status of Battery/Bluetooth/3G/ Wireless LAN communication. (only for certain models)
7		Click buttons (left and right)	The left and right buttons function like the left and right mouse buttons.

No.	Icon	Item	Description
8		Status indicators	Light-Emitting Diodes (LEDs) that light up to show the status of the computer's functions and components.
9		Power button/ indicator	Turns the computer on and off while indicating the computer's power status.





Closed Front View



No.	Icon	Item	Description
1		Bluetooth communication switch	Enables/disables the Bluetooth function.
2		3G/Wireless LAN communication switch	Enables/disables the 3G/Wireless LAN

Left View



No.	Icon	Item	Description
1		Ethernet (RJ-45) port	Connects to an Ethernet 10/100-based network.
2		DC-in jack	Connects to an AC adapter
3		USB 2.0 ports	Connect to USB 2.0 devices (e.g. USB mouse).
4		Microphone-in jack	Accepts input from external microphones.
5		Headphones/ speaker/line-out jack	Connects to line-out audio devices (e.g. speakers, headphones).







Right View

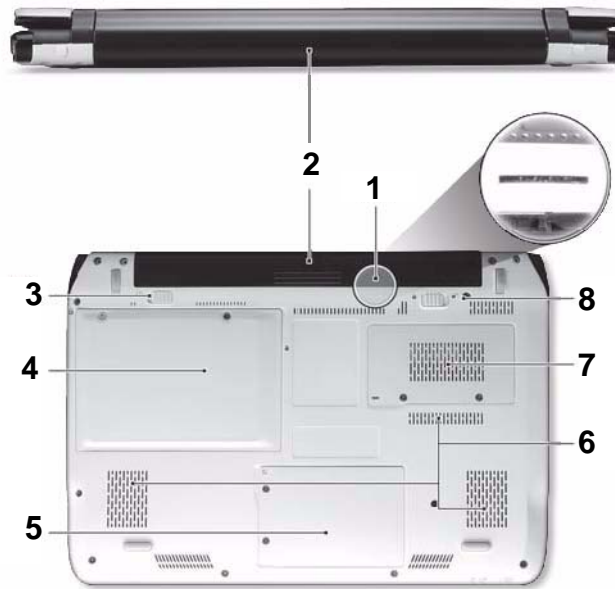

No.	Icon	Item	Description
1		Multi-in-1 card reader	Accepts Secure Digital (SD), MultiMediaCard (MMC), Memory Stick (MS), Memory Stick PRO (MS PRO), xD-Picture Card (xD). Note: Push to remove/install the card. Only one card can operate at any given time.
2		USB 2.0 port	Connects to USB 2.0 devices (e.g. USB mouse).
3		Kensington lock slot	Connects to a Kensington-compatible computer security lock.
4		External display (VGA) port	Connects to a display device (e.g. external monitor, projector).







Rear and Base View



No.	Icon	Item	Description
1		3G SIM card slot	Accepts a 3G SIM card for 3G connectivity. Note: Insert a 3G SIM card to enable 3G communication. The SIM card connectors need to face away from the cover. (only for certain models).
2		Battery bay	Houses the computer's battery pack. Note: The battery shown is for reference only. Your PC may have a different battery, depending on the model purchased.
3		Battery lock	Locks the battery in position.
4		Hard disk bay	Houses the computer's hard disk (secured with screws).
5		Wireless LAN Bay	Houses the computer's Wireless LAN module.
6		Ventilation slots and cooling fan	Enable the computer to stay cool, even after prolonged use. Note: Do not cover or obstruct the fan opening.
7		Memory compartment	Houses the computer's main memory.
8		Battery release latch	Releases the battery for removal.

Indicators

The computer has several easy-to-read status indicators. The battery indicator is visible even when the computer cover is closed.

Icon	Function	Description
	Bluetooth	Indicates the status of Bluetooth communication.
	Wireless LAN	Indicates the status of Wireless LAN communication.
	3G communication	Indicates the status of 3G communication.
	HDD	Indicates when the hard disk drive is active.
	Num Lock	Lights up when Num Lock is activated.
	Caps Lock	Lights up when Caps Lock is activated.
	Battery	Indicates the computer's battery status.

NOTE: 1. **Charging:** The battery light shows amber when the battery is charging. 2. **Fully charged:** The light shows green when in AC mode.

TouchPad Basics

The following items show you how to use the TouchPad:

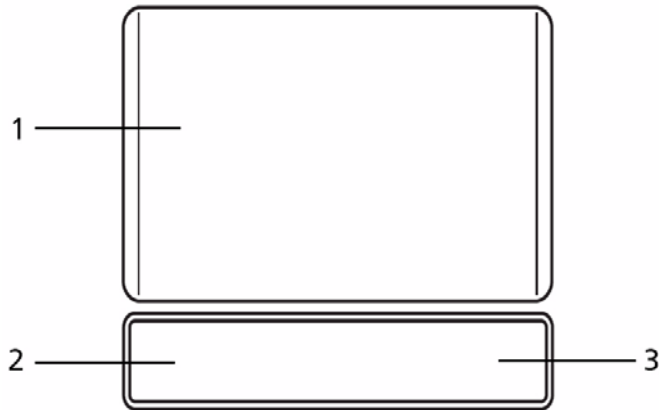

- Move your finger across the TouchPad (1) to move the cursor.
- Press the left (2) and right (3) buttons located beneath the TouchPad to perform selection and execution functions. These two buttons are similar to the left and right buttons on a mouse. Tapping on the TouchPad is the same as clicking the left button.

Function	Left Button (2)	Right Button (3)	Main TouchPad (1)
Execute	Quickly click twice.		Tap twice (at the same speed as double-clicking a mouse button).
Select	Click once.		Tap once.
Drag	Click and hold, then use finger on the TouchPad to drag the cursor.		Tap twice (at the same speed as double-clicking a mouse button); rest your finger on the TouchPad on the second tap and drag the cursor.
Access context menu		Click once.	

NOTE: When using the TouchPad, keep it - and your fingers - dry and clean. The TouchPad is sensitive to finger movement; hence, the lighter the touch, the better the response. Tapping too hard will not increase the TouchPad's responsiveness.

Using the Keyboard

Your Aspire one has a close-to-full-sized keyboard and an embedded numeric keypad, separate cursor, lock, function and special keys.

Lock Keys and embedded numeric keypad

The keyboard has three lock keys which you can toggle on and off.

















Lock key	Description
Caps Lock	When Caps Lock is on, all alphabetic characters typed are in uppercase.
Num Lock <Fn> + <F11>	When Num Lock is on, the embedded keypad is in numeric mode. The keys function as a calculator (complete with the arithmetic operators +, -, *, and /). Use this mode when you need to do a lot of numeric data entry. A better solution would be to connect an external keypad.
Scroll Lock <Fn> + <F12>	When Scroll Lock is on, the screen moves one line up or down when you press the up or down arrow keys respectively. Scroll Lock does not work with some applications.

The embedded numeric keypad functions like a desktop numeric keypad. It is indicated by small characters located on the upper right corner of the keycaps. To simplify the keyboard legend, cursor-control key symbols are not printed on the keys.

Desired access	Num Lock on	Num Lock off
Number keys on embedded keypad	Type numbers in a normal manner.	
Cursor-control keys on embedded keypad	Hold <Shift> while using cursor-control keys.	Hold <Fn> while using cursor-control keys.
Main keyboard keys	Hold <Fn> while typing letters on embedded keypad.	Type the letters in a normal manner.

Windows Keys













The keyboard has two keys that perform Windows-specific functions.

Key	Description
 Windows key	<p>Pressed alone, this key has the same effect as clicking on the Windows Start button; it launches the Start menu. It can also be used with other keys to provide a variety of functions:</p> <ul style="list-style-type: none"><  >: Open or close the Start menu<  > + < D >: Display the desktop<  > + < E >: Open Windows Explore<  > + < F >: Search for a file or folder<  > + < L >: Lock your computer (if you are connected to a network domain), or switch users (if you're not connected to a network domain)<  > + < M >: Minimizes all windows<  > + < R >: Open the Run dialog box<  > + < U >: Open Ease of Access Center<  > + < BREAK >: Display the System Properties dialog box<  > + < SHIFT+M >: Restore minimized windows to the desktop<  > + < TAB >: Cycle through programs on the taskbar by using Windows Flip 3-D<  > + < SPACEBAR >: Bring all gadgets to the front and select Windows Sidebar< CTRL > + <  > + < F >: Search for computers (if you are on a network)< CTRL > + <  > + < TAB >: Use the arrow keys to cycle through programs on the taskbar by using Windows Flip 3-D <p>Note: Depending on your edition of Windows Vista, some shortcuts may not function as described.</p>
 Application key	This key has the same effect as clicking the right mouse button; it opens the application's context menu.

Hot Keys

The computer employs hotkeys or key combinations to access most of the computer's controls like screen brightness and volume output.

To activate hotkeys, press and hold the **<Fn>** key before pressing the other key in the hotkey combination.

Hotkey	Icon	Function	Description
<Fn> + <F1>		Power Options	Display the Power Options Properties dialog box.
<Fn> + <F2>		System Properties	Display the System Properties dialog box.
<Fn> + <F3>		Bluetooth communication switch	Enables/disables the Bluetooth function.
<Fn> + <F4>		Sleep	Puts the computer in Sleep mode.
<Fn> + <F5>		Display toggle	Switches display output between the display screen, external monitor (if connected) and both.
<Fn> + <F6>		Screen blank	Turns the display screen backlight off to save power. Press any key to return.
<Fn> + <F7>		TouchPad toggle	Turns the internal TouchPad on and off.
<Fn> + <F8>		Speaker toggle	Turns the speakers on and off.
<Fn> + <▷>		Brightness up	Increases the screen brightness.
<Fn> + <◁>		Brightness down	Decreases the screen brightness.
<Fn> + <△>		Volume up	Increases the sound volume.
<Fn> + <▽>		Volume down	Decreases the sound volume.

Special Keys

You can locate the Euro symbol and the US dollar sign at the upper-center and/or bottom-right of your keyboard.

The Euro symbol

1. Open a text editor or word processor.
2. Hold <Alt Gr> and then press the <5> key at the upper-center of the keyboard.

NOTE: Some fonts and software do not support the Euro symbol. See www.microsoft.com/typography/faq/faq12.htm for more information.

The US dollar sign

1. Open a text editor or word processor.
2. Hold <Shift> and then press the <4> key at the upper-center of the keyboard.

NOTE: This function varies according to the language settings.

Hardware Specifications and Configurations

Processor

Item	Specification
CPU type	Intel Atom Z520(1.33GHz), Z530(1.6GHz) (Silverthorne)
CPU package	13 x 14mm, Micro-FCBGA
Core Logic	<ul style="list-style-type: none"> Mobile Intel® US15W Express Chipset Intel Poulso AF82US15W (Controller Hub)
Chipset	<ul style="list-style-type: none"> Mobile Intel® US15W Express Chipset
Features	<ul style="list-style-type: none"> Hyper-Threading Technology Intel® Virtualization Technology Execute Disable Bit

Processor Specifications

Item	CPU Speed	Cores	Bus Speed	Mfg Tech	Cache Size	Package	Core Voltage	Acer P/N
Z520	1.33 GHz	1	533 MHz	45 nm	512 KB	Micro-FCBGA	0.75-1.1V	
Z530	1.6 GHz	1	533 MHz	45 nm	512 KB	Micro-FCBGA8	0.75-1.1V	

CPU Fan True Value Table

CPU Temperature of Diode	Fan Speed (RPM)	SPL Spec (dBA)
46	5000	26
52	5700	29
62	6400	31
72	7500	35

- Throttling 50%: On=92C; Off=90C
- OS shut down = 95C
- H/W shut down = 100C

System Controller Hub

Item	Specification
Chipset	Intel Poulso AF82US15W (Controller Hub)
Package	FCBGA 1249-pin
Features	<ul style="list-style-type: none"> 400MHz and 533MHz FSB support Maximum memory support: 2GB Support for DDR2 at 667MHz and 533MHz

System Memory

Item	Specification
Memory controller	Intel Poulsbo AF82US15W
Memory size	2GB
DIMM socket number	1
Supports memory size per socket	2GB
Supports maximum memory size	2GB
Supports DIMM type	DDR2
Supports DIMM Speed	667MHz/533MHz

Hard Disk Drive Interface

Item	Specification					
Vendor & Model Name	Seagate ST9160310AS	Seagate ST9250315AS	Hitachi HTS543216	Hitachi HTS545016	WD WD1600BEVT	Toshiba MK1655GSX
Capacity (GB)	160	250	160	160	160	160
Bytes per sector	512	512	512	512	512	512
Data heads	2	2	2	2	2	2
Drive Format						
Disks	1	1	1	1	1	1
Spindle speed (RPM)	5400	5400	5400	5400	5400	5400
Performance Specifications						
Buffer size	8 MB	8 MB	8 MB	8 MB	8 MB	8
Interface	SATA	SATA	SATA	SATA	SATA	SATA
Fast data transfer rate (Mbits/sec, max)	830	1175	1500	3000	3000	363 - 952 typical
Media data transfer rate (Mbytes/sec max)	300	300	729	775	850	3
DC Power Requirements						
Voltage tolerance	5V ±5%	5V ±5%	5V ±5%	5V ±5%	5V ±5%	5V ±5%

BIOS

Item	Specification
BIOS vendor	Pheonix BIOS
BIOS Version	V0.2105
BIOS ROM type	Flash
BIOS ROM size	

LED 11.6"

Item	Specifications			
Vendor/model name	AUO B11.6XW02	CMO N116B6-L02	LG LP116WH1-TLA1	Samsung LTN116AT01-A01
Screen Diagonal (mm)	11.6"	11.6"	11.6"	11.6"
Active Area (mm)	256.125 x 144	256.125 x 144	256.13 x 144	256.125 x 144
Display resolution (pixels)	1366 x 768	1366 x 768	1366 x 768	1366 x 768
Pixel Pitch (mm)	0.1875 x 0.1875	0.1875 x 0.1875	0.1875 x 0.1875	0.2265(H) x 0.2265(V)
Typical White Luminance (cd/m ²) also called Brightness	200	200	200	200
Contrast Ratio	500:1	500:1	500:1	500:1
Response Time (Optical Rise Time/Fall Time) msec	8	7	8	8
Typical Power Consumption (watt)	4.0	4	4	2.85
Weight (without inverter)	255g	225g	255g	255g
Physical Size (mm)	268 (L) x 161.5 (W)	268 x 161.5 x 5	268.0 x 161.5	268.0 x 161.5
Electrical Interface	LVDS	LVDS	LVDS	LVDS
Viewing Angle (degree) Horizontal (Right) / (Left) Vertical (Upper) / (Lower)	45/45 20/40	45/45 20/45	45/45 20/40	TBD

Bluetooth

Item	Specification
Bluetooth Controller	T60H928.11 miniUSB module
Features	<ul style="list-style-type: none"> • Bluetooth 2.0 plus EDR qualified Embedded USB Module • Extremely small size (26mmX 14mm) • Class 2 specification RF output power • Full piconet and scatternet operation • Full Bluetooth data rate • USB 2.0 full-speed compliant interface • F/W upgrade via Flash download • Very low power consumption • Support AFH (Adaptive Frequency Hopping) • Support BCM WLAN co-existence

Audio Codec and Amplifier

Item	Specification
Audio Controller	Realtek ALC272 Azalia Codec and Amplifier G1454
Features	<ul style="list-style-type: none"> • HD Audio • SNR > 85, High-performance DACs with 95dB SNR (A-Weighting), ADCs with 85dB SNR (A-Weighting) • Internal Digital Microphone • Two speakers, max. 1W output for each • Meets performance and function requirements for Microsoft WLP 3.10, and stricter performance requirements for future WLP • Two stereo DAC support 16/20/24-bit PCM for two independent playback (multiple streaming) • Two stereo ADC supports 16/20/24-bit PCM format for two independent recording • All DACs support independent 44.1k/48k/96k/192kHz sample rate • All ADCs support independent 44.1k/48k/96k/192kHz sample rate • Two independent SPDIF outputs support 16/20/24-bit format and 44.1k/48k/88.2k/96k/192kHz rate • All analog jack ports except MONO, BEEP-IN and HP-OUT are stereo input and output re-tasking • Supports line level mono output • Supports analog PCBEEP input, and features an integrated digital BEEP generator • Support two stereo digital microphone input for microphone array AEC/BF application • Each stereo digital microphone interface has its own clock output to support independent sample rate • Supports legacy analog mixer architecture • Built-in five headphone amplifiers on port-A and port-D, port-E, port-F and port-I. • Headphone amplifier on port-I (HP-OUT) is designed to drive output without external DC blocking capacitors • Software selectable 2.5V and 3.2V reference output for microphone bias • Software selectable boost gain (+10/+20/+30dB) for analog microphone input • Two jack detection pins; each supports detection of up to 4 jacks • Supports two GPIO (General Purpose Input/Output) pins (pin sharing with digital microphone interface) • Supports EAPD (External Amplifier Power Down) control for external amplifier • Supports anti-pop mode when analog power AVDD is on and digital power is off • Supports 1.5V~3.3V scalable I/O for HD Audio link • 48-pin LQFP 'Green' package

LAN Interface

Item	Specification
LAN Chipset	Realtek RTL8103A-GR
Package	48pin-LQFP package
Features	<ul style="list-style-type: none"> Integrated 10/100 BASE -T transceiver PCIe V1.1 compliant supports Wake on LAN and remote wake-up support

Modem

Item	Specification
Modem Module	D-1156U#/A9B soft modem
Package	20-pin TSSOP package
Features	<ul style="list-style-type: none"> Two-chip USB 2.0-compliant soft modem solution: <ul style="list-style-type: none"> SV92U2 host interface in a 48-pin TQFP. CSP1040 DAA in a 20-pin TSSOP. Data mode capabilities: <ul style="list-style-type: none"> ITU-T V.92*: 56000 bits/s.28000 bits/s. ITU-T V.90*: 56000 bits/s.28000 bits/s. ITU-T V.34: 33600 bits/s.2400 bits/s. V.32bis and fallbacks. V.44, V.42, V.42 bis, and MNP. Class 5 data compression. High compression throughput due to parallel access directly to the host PC. Fax mode capabilities: <ul style="list-style-type: none"> ITU-T T.31 class 1 FAX. ITU-T V.17: 14400 bits/s, 12000 bits/s, 9600 bits/s, 7200 bits/s (TCM). ITU-T V.29: 9600 bits/s, 7200 bits/s (QAM). ITU-T V.27ter: 4800 bits/s, 2400 bits/s (DPSK). ITU-T V.21 Channel 2: 300 bits/s (FSK). CSP1040 <ul style="list-style-type: none"> System-powered. Proprietary transformer-based isolation barrier. Programmable event detect for caller-ID reception and power ring detection. Programmable pulse shaping and spark quench Programmable dc-impedance termination for country-specific VI templates. Programmable ac-impedance termination for return loss matching. Programmable ringer-impedance emulation. USB 2.0 compliant device controller. <ul style="list-style-type: none"> Integrated ARM7TDMS core. Integrated high/full-speed USB transceivers. Suitable for bus-powered USB device applications. 2 Kbytes USB FIFO memory. Wake on ring support Overload Detection

Keyboard

Item	Specification
Type	New Acer flat keyboard
Total number of keypads	86/87/91
Windows logo key	Yes
Internal & external keyboard work simultaneously	Yes
Features	<ul style="list-style-type: none">Support Application keys for Windows XP version

Mini Card

Item	Specification
Number Supported	2
Features	<ul style="list-style-type: none">1 for 3G/ WiMAX (full size)1 for WLAN (half size)
Wireless LAN Standards	IEEE 802.11b/11g standard
Operating Frequency	2.400 – 2.497 GHz
WLAN Data Rate	<ul style="list-style-type: none">IEEE 802.11g: 54Mbps with fall back of 48, 36, 24, 18, 12, 9, 6Mbps.IEEE 802.11b with fall back rates of 11, 5.5, 2, and 1Mbps
Modulation Schemes	<ul style="list-style-type: none">IEEE 802.11b/11g: 64QAM (54Mbps, 48Mbps), 16QAM (36Mbps,24Mbps), QPSK (18Mbps, 12Mbps), BPSK (9Mbps, 6Mbps)802.11b: CCK (11 Mbps, 5.5Mbps), DQPSK (2 Mbps), DBPSK (1 Mbps)

Camera

Item	Specifications	
Vendor and model	Liteon 09P2SF001	SuyinCN0316-S30C-OV06-1
Type	640 x 480 VGA (0.3M) size CMOS	640 x 480 VGA (0.3M) size CMOS
Interface	USB 2.0	USB 2.0
Optical aperture	F2.4 ± 5%	F2.4
Focusing range	18.65cm~Infinite, focus on 48cm	40 cm ~ infinity
Dimensions (L x W x H mm)	65 x 8 x 3.84 ± 0.25(H) mm,	65X 7.9X 3.8+/-0.2mm
Sensor type	CMOS	CMOS
Pixel resolution	640 x 480	640 x 480
Pixel size	TBD	3.6um x 3.6um
Image size	TBD	2.36mm(H) x 1.76mm(V)

Wireless LAN

Item	Specification
Type	Atheros AR2425
802.11g	
Radio Technology	IEEE 802.11g standard compliant
Operating Frequency	2412 ~ 2472MHz ISM band
Modulation Schemes	OFDM, DQPSK, DBPSK and CCK

Item	Specification
Channel Numbers	<ul style="list-style-type: none"> 1---11 channels for active channels 12---13 channels for passive channels
Data Rate	54Mbps with fall back rates of 48, 36, 24, 18, 12, 9 and 6Mbps
Media Access Protocol	CSMA/CA with ACK
Transmitter Output Power	Typical 13.5 dBm for 54Mbps
802.11b	
Radio Technology	IEEE 802.11b Direct Sequence Spread Spectrum
Operating Frequency	2412 ~ 2472MHz ISM band
Modulation Schemes	DQPSK, DBPSK and CCK
Channel Number	<ul style="list-style-type: none"> 1---11 channels for active channels 12---13 channels for passive channels
Data Rate	11Mbps with fall back rates of 5.5, 2, and 1Mbps
Media Access Protocol	CSMA/CA with ACK
Transmitter Output Power	18dBm typically

Battery

Item	Specification	
	3 Cell	6 Cell
Vendor & model name	Sanyo UM-2009A/AW Sony UM-2009A/AW Panasonic UM-2009A/AW Simplo UM-2009A/AW	Sanyo UM-2009B 2.2/2.6 Simplo UM-2009B Panasonic UM-2009B
Battery Type	Li-ion	Li-ion
Pack capacity	2200 mAh	4400/5200 mAh
Number of battery cell	3	6
Package configuration	3S1P	3S2P

System Utilities

BIOS Setup Utility

The BIOS Setup Utility is a hardware configuration program built into your computer's BIOS (Basic Input/Output System).

Your computer is already properly configured and optimized, and you do not need to run this utility. However, if you encounter configuration problems, you may need to run Setup. Please also refer to Chapter 4 Troubleshooting when problem arises.

To activate the BIOS Utility, press **F2** during POST (when **Press <F2> to enter Setup** message is prompted on the bottom of screen).

Press **F2** to enter setup. The default parameter of F12 Boot Menu is set to "disabled". If you want to change boot device without entering BIOS Setup Utility, please set the parameter to "enabled".

Press **<F12>** during POST to enter multi-boot menu. In this menu, user can change boot device without entering BIOS SETUP Utility.

Navigating the BIOS Utility

There are six menu options: Information, Main, Advanced, Security, Power, Boot, and Exit.

Follow these instructions:

- To choose a menu, use the left and right arrow keys.
- To choose an item, use the up and down arrow keys.
- To change the value of a parameter, press **F5** or **F6**.
- A plus sign (+) indicates the item has sub-items. Press **Enter** to expand this item.
- Press **Esc** while you are in any of the menu options to go to the Exit menu.
- In any menu, you can load default settings by pressing **F9**. You can also press **F10** to save any changes made and exit the BIOS Setup Utility.

NOTE: You can change the value of a parameter if it is enclosed in square brackets. Navigation keys for a particular menu are shown on the bottom of the screen. Help for parameters are found in the Item Specific Help part of the screen. Read this carefully when making changes to parameter values. **Please note that system information is subject to different models.**

Information

The Information screen displays a summary of your computer hardware information.

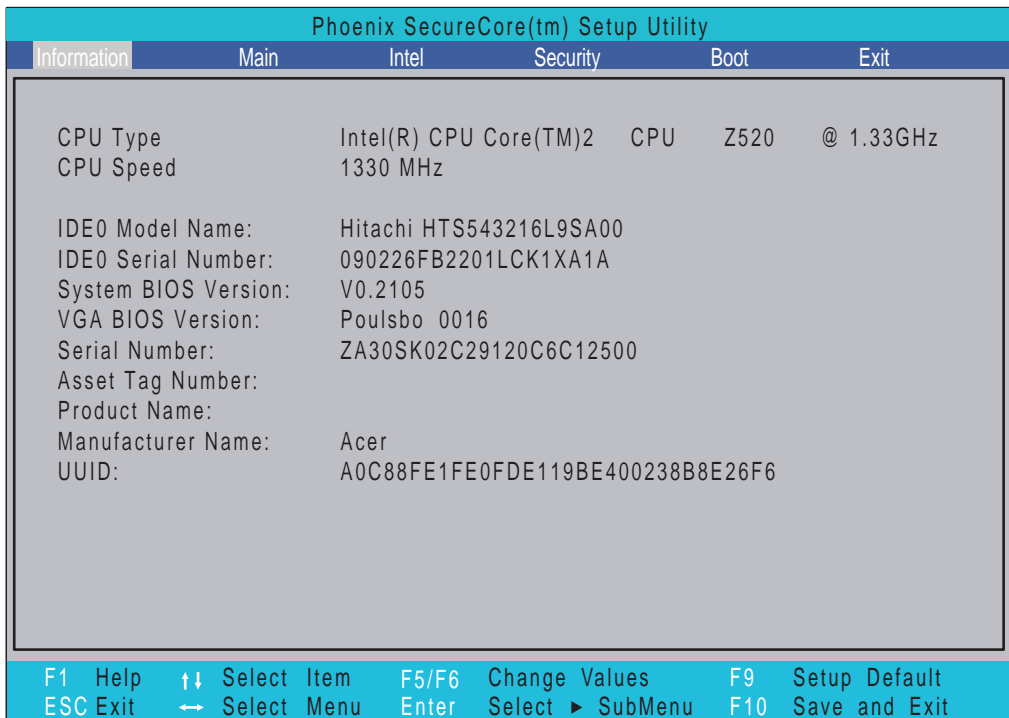

NOTE: The system information is subject to different models.

Parameter	Description
CPU Type	This field shows the CPU type and speed of the system.
CPU Speed	This field shows the speed of the CPU.
IDE0 Model Name	This field shows the model name of HDD installed on primary IDE master.
IDE0 Serial Number	This field displays the serial number of HDD installed on primary IDE master.
System BIOS Version	Displays system BIOS version.
VGA BIOS Version	This field displays the VGA firmware version of the system.
Serial Number	This field displays the serial number of this unit.
Asset Tag Number	This field displays the asset tag number of the system.
Product Name	This field shows product name of the system.
Manufacturer Name	This field displays the manufacturer of this system.
UUID	Universally Unique Identifier (UUID) is an identifier standard used in software construction, standardized by the Open Software Foundation (OSF) as part of the Distributed Computing Environment (DCE).

Main

The Main screen allows the user to set the system time and date as well as enable and disable boot option and recovery.

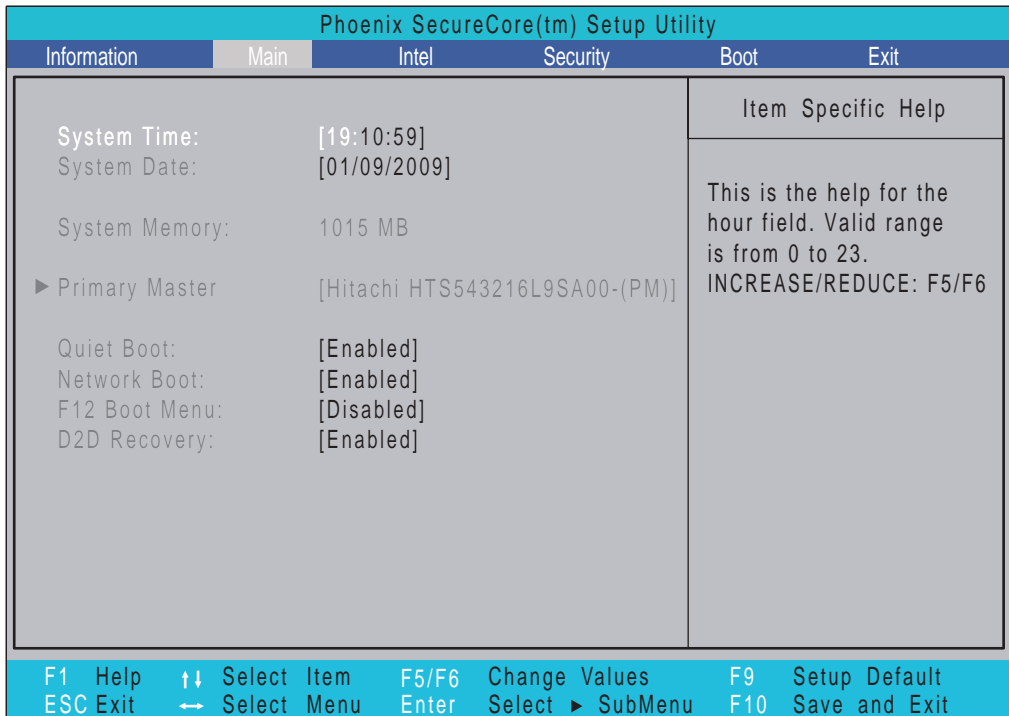

NOTE: The screen above is for your reference only. Actual values may differ.

The table below describes the parameters in this screen. Settings in **boldface** are the default and suggested parameter settings.

Parameter	Description	Format/Option
System Time	Sets the system time. The hours are displayed with 24-hour format.	Format: HH:MM:SS (hour:minute:second)
System Date	Sets the system date.	Format MM/DD/YYYY (month/day/year)
System Memory	This field reports the total memory size of the system. Memory size is fixed to 1015 MB.	N/A
Quiet Boot	Allows startup to skip normal POST messages while booting, decreasing the time needed to boot the system.	Option: Enabled or Disabled
Network Boot	Enables, disables the system boot from LAN (remote server).	Option: Enabled or Disabled
F12 Boot Menu	Enables, disables Boot Menu during POST.	Option: Enabled or Enabled
D2D Recovery	Enables, disables D2D Recovery function. The function allows the user to create a hidden partition on hard disc drive to store operation system and restore the system to factory defaults.	Option: Enabled or Disabled

Intel

The Intel screen allows the user to control various CPU and graphics processor parameters.

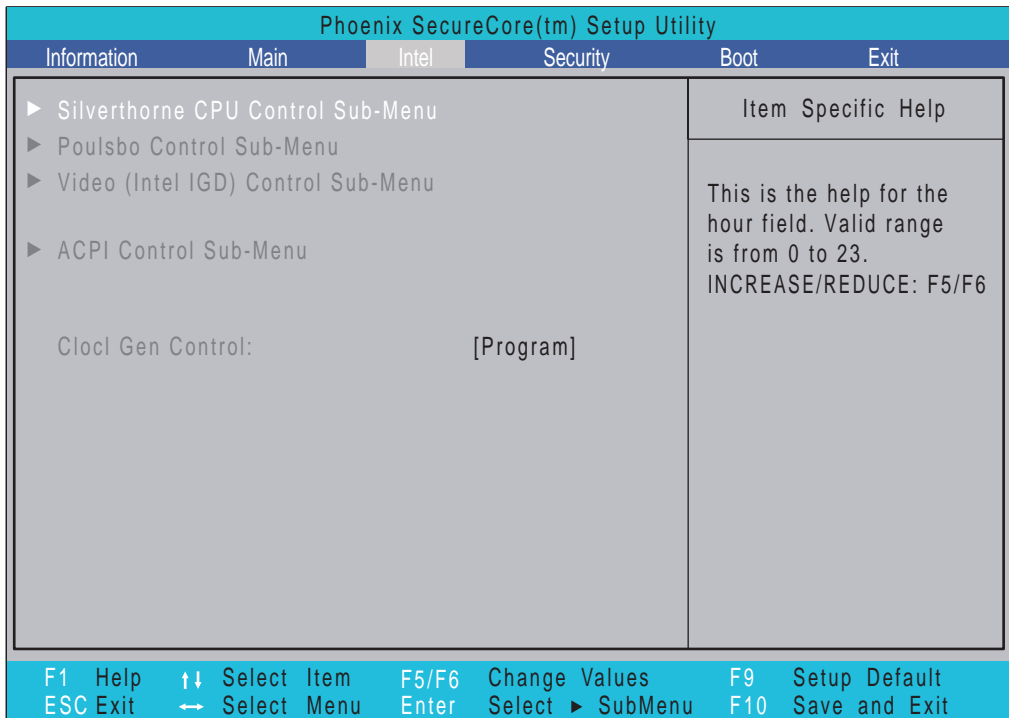

NOTE: The screen above is for your reference only. Actual values may differ.

The table below describes the parameters in this screen. Settings in **boldface** are the default and suggested parameter settings.

Parameter	Description	Format/Option
Silverthorne CPU Control Sub-Menu	Enter the CPU Control menu.	<ul style="list-style-type: none"> • Hyperthreading • Processor Power Management • CPU Thermal Control Sub-Menu • No Execute Modem Mem Protection • Intel (R) Virtualization Technology • Set Max Ext CPUID = 3

Parameter	Description	Format/Option
Poulsbo Control Sub-Menu	Enter the Poulsbo control menu.	<ul style="list-style-type: none"> • PCI Express Control Sub-Menu • Poulsbo USB Control Sub-Menu • Azalia - Device 27, Function 0: • SDIO - Device 30, Function 0/1/2: • PCI Clock Run: • Serial IRQ Quiet Mode: • Pop Up Mode Enable: <ul style="list-style-type: none"> • Pop Down Mode Enable:
Video (Intel IGD) Control Sub-Menu	Enter the Video Control menu.	<ul style="list-style-type: none"> • IGD - Device 2: • IGD - Boot Type: • IGD - LCD Control Sub-Menu • IGD - TV Control Sub-Menu <ul style="list-style-type: none"> • Pre-Allocated Memory Size: • Graphic Memory Aperture Size:
ACPI Control Sub-Menu	Enter the ACPI Control menu.	<ul style="list-style-type: none"> • Active Trip Point: • Passive Cooling Trip Point: <ul style="list-style-type: none"> • Passive TC1 Value: • Passive TC2 Value: • Passive TSP Value: • Critical Trip Point: • FACP - RTC S4 Flag Value: • FACP - PM Timer Flag Value: • HPET Support: <ul style="list-style-type: none"> • HPET Base Address: • ALS Support: • EMA Support:
Clock Gen Control:	Enables you to specify the clock generation control for the clock circuit.	Option: Program or ?

Security

The Security screen contains parameters that help safeguard and protect your computer from unauthorized use.

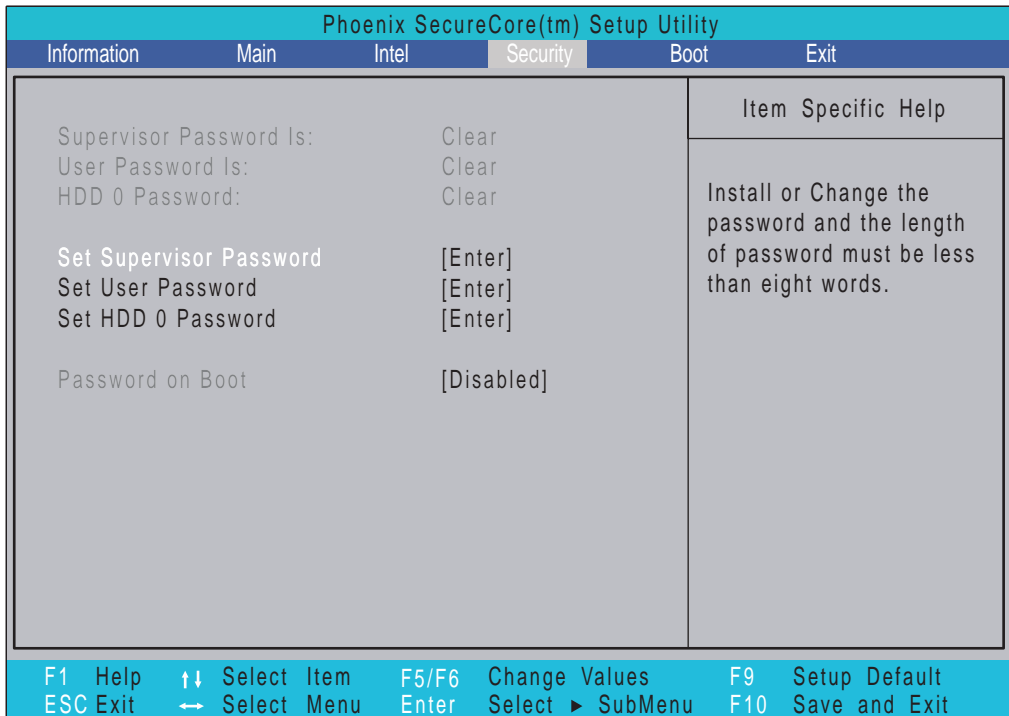

The table below describes the parameters in this screen. Settings in **boldface** are the default and suggested parameter settings.

Parameter	Description	Option
Supervisor Password Is	Shows the setting of the Supervisor password	Clear or Set
User Password Is	Shows the setting of the user password.	Clear or Set
HDD0 Password IS	Shows the setting of the HDD password	Clear or Set
Set Supervisor Password	Press Enter to set the supervisor password. When set, this password protects the BIOS Setup Utility from unauthorized access. The user can not either enter the Setup menu nor change the value of parameters.	
Set User Password	Press Enter to set the user password. When user password is set, this password protects the BIOS Setup Utility from unauthorized access. The user can enter Setup menu only and does not have right to change the value of parameters.	
Set HDD0 Password	Enter HDD password.	
Password on Boot	Defines whether a password is required or not while the events defined in this group happened. The following sub-options are all requires the Supervisor password for changes and should be grayed out if the user password was used to enter setup.	Enabled or Disabled

NOTE: When you are prompted to enter a password, you have three tries before the system halts. Don't forget your password. If you forget your password, you may have to return your notebook computer to your dealer to reset it.

Setting a Password

Follow these steps as you set the user or the supervisor password:

1. Use the ↑ and ↓ keys to highlight the Set Supervisor Password parameter and press the **Enter** key. The Set Supervisor Password box appears:

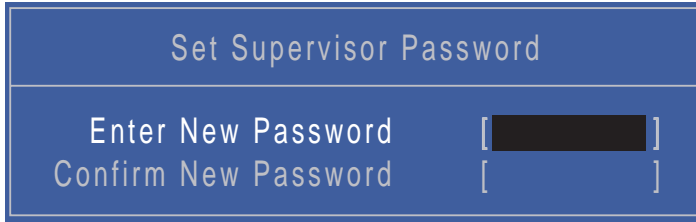

The screenshot shows a blue BIOS screen titled "Set Supervisor Password". Below the title, there are two input fields: "Enter New Password" and "Confirm New Password". The "Enter New Password" field contains a blacked-out password, and the "Confirm New Password" field is empty.

2. Type a password in the "Enter New Password" field. The password length can not exceed 8 alphanumeric characters (A-Z, a-z, 0-9, not case sensitive). Retype the password in the "Confirm New Password" field.

IMPORTANT: Be very careful when typing your password because the characters do not appear on the screen.

3. Press **Enter**. After setting the password, the computer sets the User Password parameter to "Set".
4. If desired, you can opt to enable the Password on boot parameter.
5. When you are done, press F10 to save the changes and exit the BIOS Setup Utility.

Removing a Password

Follow these steps:

1. Use the ↑ and ↓ keys to highlight the Set Supervisor Password parameter and press the **Enter** key. The Set Password box appears:



The screenshot shows a blue BIOS screen titled "Set Password". Below the title, there are three input fields: "Enter Current Password", "Enter New Password", and "Confirm New Password". The "Enter Current Password" field contains a blacked-out password, while the other two fields are empty.

2. Type the current password in the Enter Current Password field and press **Enter**.
3. Press **Enter** twice **without** typing anything in the Enter New Password and Confirm New Password fields. The computer then sets the Supervisor Password parameter to "Clear".
4. When you have changed the settings, press u to save the changes and exit the BIOS Setup Utility.

Changing a Password

1. Use the ↑ and ↓ keys to highlight the Set Supervisor Password parameter and press the **Enter** key. The Set Password box appears.



The screenshot shows a blue BIOS screen titled "Set Supervisor Password". Below the title, there are three input fields, each with a cursor and a pair of brackets: "Enter Current Password", "Enter New Password", and "Confirm New Password".

2. Type the current password in the Enter Current Password field and press **Enter**.
3. Type a password in the Enter New Password field. Retype the password in the Confirm New Password field.
4. Press **Enter**. After setting the password, the computer sets the User Password parameter to "Set".
5. If desired, you can enable the Password on boot parameter.
6. When you are done, press **F10** to save the changes and exit the BIOS Setup Utility.

If the verification is OK, the screen will display as following.

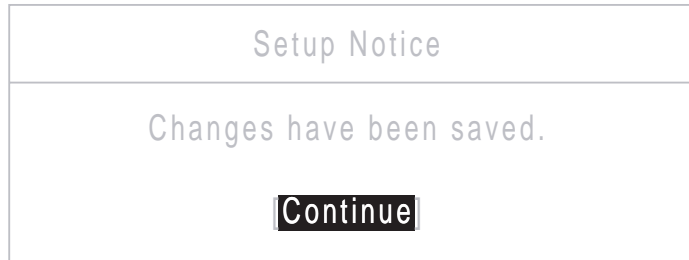

The screenshot shows a white BIOS screen titled "Setup Notice". Below the title, the text "Changes have been saved." is displayed. At the bottom, there is a black button with the word "Continue" in white.

The password setting is complete after the user presses **Enter**.

If the current password entered does not match the actual current password, the screen will show you the Setup Warning.



The screenshot shows a white BIOS screen titled "Setup Warning" in red. Below the title, the text "Invalid Password." is displayed in red. At the bottom, there is a black button with the word "Continue" in white.

If the new password and confirm new password strings do not match, the screen displays the following message.



The screenshot shows a white BIOS screen titled "Setup Warning" in red. Below the title, the text "Passwords do not match. Re-enter password." is displayed in red. At the bottom, there is a black button with the word "Continue" in white.

Boot

This menu allows the user to decide the order of boot devices to load the operating system. Bootable devices includes the USB diskette drives, the onboard hard disk drive and the DVD drive in the module bay.

Phoenix SecureCore(tm) Setup Utility					
Information	Main	Security	Intel	Boot	Exit
Boot priority order:				Item Specific Help	
1. IDE HDD: Hitachi HTS543216L9SA00-(P)				Use <↑> or <↓> to select a device, then press <F5> to move it down the list, or <F6> to move it up the list. Press <Esc> to escape the menu	
2. IDE CD:					
3. PCI BEV: Realtek Boot Agent					
4. USB HDD:					
5. USB CDROM:					
6. USB FDC:					
7. USB KEY:					
8.					
Excluded from boot order:					
F1 Help	↑↓ Select Item	F5/F6 Change Values	F9 Setup Default		
ESC Exit	←→ Select Menu	Enter Select ► SubMenu	F10 Save and Exit		

Exit

The Exit screen allows you to save or discard any changes you made and quit the BIOS Utility.

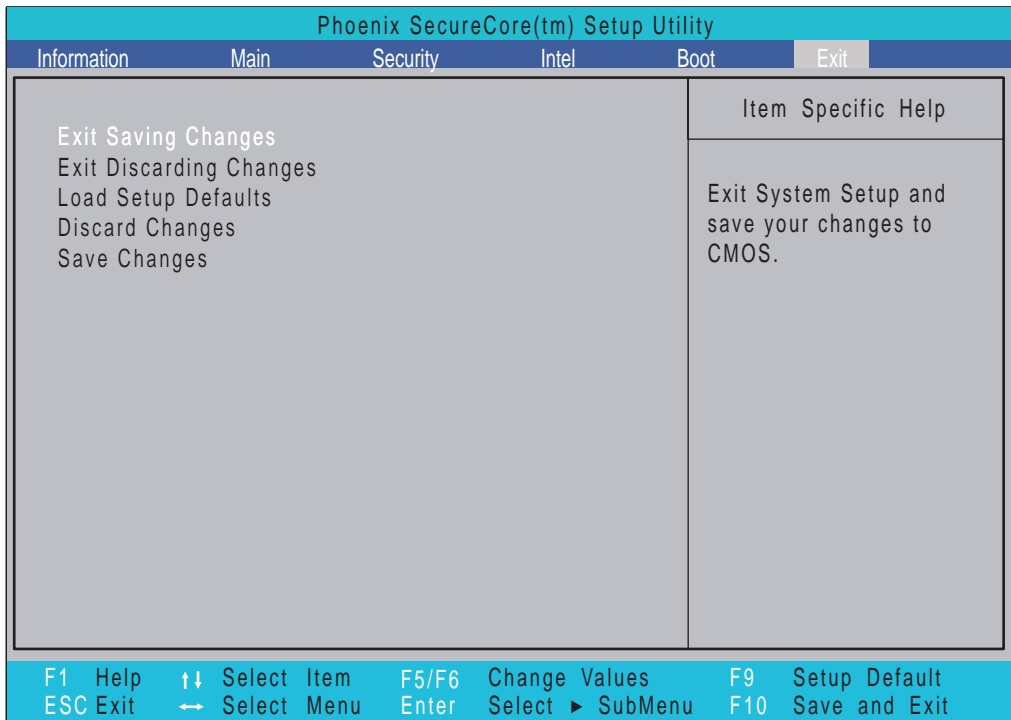

The table below describes the parameters in this screen.

Parameter	Description
Exit Saving Changes	Exit System Setup and save your changes to CMOS.
Exit Discarding Changes	Exit utility without saving setup data to CMOS.
Load Setup Default	Load default values for all SETUP item.
Discard Changes	Load previous values from CMOS for all SETUP items.
Save Changes	Save Setup Data to CMOS.

BIOS Flash Utility

The BIOS flash memory update is required for the following conditions:

- New versions of system programs
- New features or options
- Restore a BIOS when it becomes corrupted.

Use the Phlash utility to update the system BIOS flash ROM.

NOTE: If you do not have a crisis recovery diskette at hand, then you should create a **Crisis Recovery Diskette** before you use the Phlash utility.

NOTE: Do not install memory-related drivers (XMS, EMS, DPML) when you use the Phlash.

NOTE: Please use the AC adaptor power supply when you run the Phlash utility. If the battery pack does not contain enough power to finish BIOS flash, you may not boot the system because the BIOS is not completely loaded.

Fellow the steps below to run the Phlash.

1. Prepare a bootable diskette.
2. Copy the flash utilities to the bootable diskette.
3. Then boot the system from the bootable diskette. The flash utility has auto-execution function.

DOS Flash Utility

Perform the following steps to use the DOS Flash Utility:

1. Press F2 during boot to enter the Setup Menu.
2. Select **Boot Menu** to modify the boot priority order, for example, if using USB HDD to Update BIOS, move USB HDD to position 1.

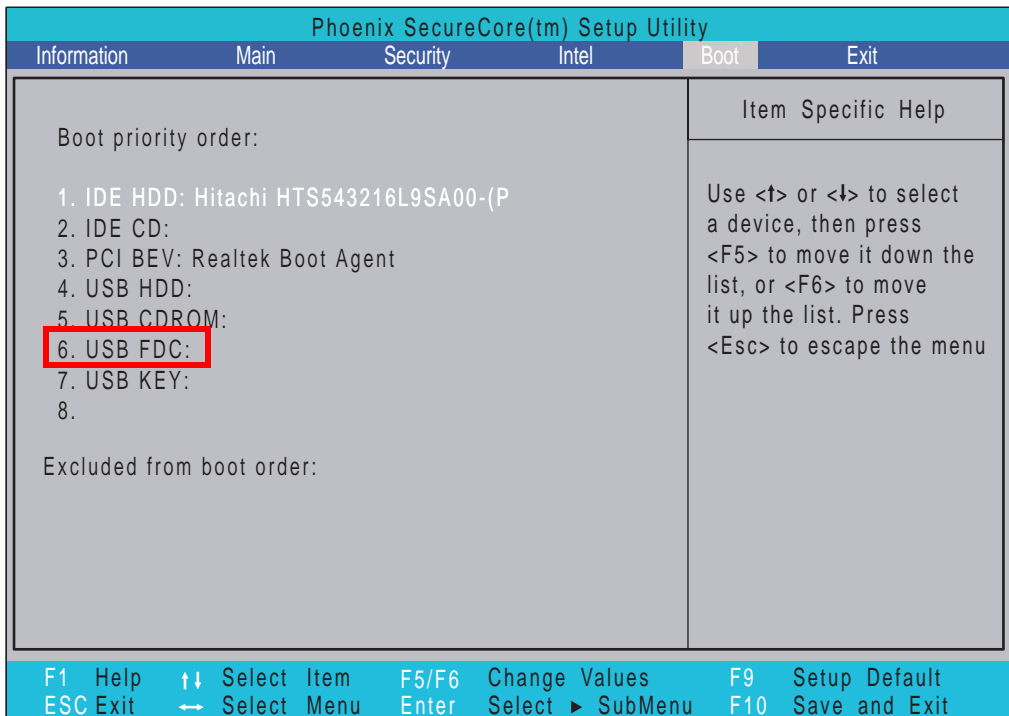

3. Execute the **IFLASH.BAT** batch file to update BIOS.

The flash process begins as shown.



4. In flash BIOS, the message **Please do not remove AC Power Source** displays.

NOTE: If the AC power is not connected, the following message displays.



Plug in the AC power to continue.

5. Flash is complete when the message Flash programming complete displays.

WinFlash Utility

Perform the following steps to use the WinFlash Utility:

1. Double click the WinFlash executable.
2. Click **OK** to begin the update. A progress screen displays.

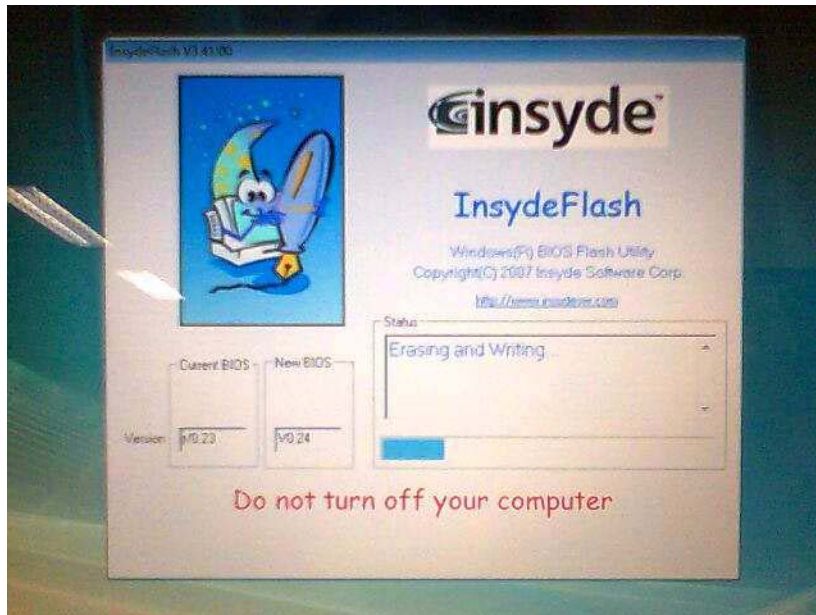

3. When the process is complete, close all programs and applications and reboot the system.

Remove HDD/BIOS Password Utilities

This section provides you with details about removing HDD/BIOS password methods:

Removing HDD Password:

If you key in the wrong HDD password three times, an error code is generated.



To reset the HDD password, perform the following steps:

1. On a different machine, run the **HDD_PW.EXE** file along with the error code generated. For example:
hdd_pw 15494 0
2. Select an option to generate upper case or lower case ASCII code for unlocking the HDD.
3. Two strings are generated as output. Select and note down either one of the strings.

```
C:\WINDOWS\system32\cmd.exe
F:\>cd password
F:\password>dir/v
Volume in drive F has no label.
Volume Serial Number is D4F6-0236

Directory of F:\password

[.]          [.]          BIOS_PW.EXE  HDD_PW.EXE
1.           2 File(s)    35,354 bytes
2.           2 Dir(s)    487,895,040 bytes free

F:\password>hdd_pw 15494 0
unlock6.exe v1.1 2 May 2003

Choice what kind of the password to be generated:
0.) Exit....
1.) Scan Code
2.) Upper case ASCII Code
3.) Lower case ASCII Code
Enter your choice: 2
@KJFM42
UUUIQ96
```

4. Reboot the machine with the locked HDD and then use either one of the strings as the HDD user password.



Removing BIOS Passwords:

If you key in the wrong Supervisor password three times, an error code is generated and system is disabled.



To unlock the BIOS, perform the following steps:

1. On a different machine, run the **BIOS_PW.EXE** file along with the error code generated. For example:
bios_pw 14452 0
2. Four ASCII strings are generated as output. Select and note down any one of the strings.

```
ex C:\WINDOWS\system32\cmd.exe
Microsoft Windows XP [Version 5.1.2600]
(C) Copyright 1985-2001 Microsoft Corp.

C:\Documents and Settings\M54>d:
D:\>bios_pw 14452 0 1.
unlock6.exe v1.0 1 July 1997
qjjs9vy
0?yqmjd
cjl14tm
6mbzja.j 2.
D:\>_
```

3. Reboot the machine with the locked BIOS and then use either any of the strings as the BIOS user password.



Miscellaneous Utilities

Using Boot Sequence Selector

Boot Sequence Selector allows the boot order to be changes without accessing the BIOS. To use Boot Sequence Selector, perform the following steps:

1. Enter into DOS.
2. Execute BS.exe to display the usage screen.

```
d:\BOOTSEQ>bs

*** Boot Sequence Selector Version 0.03 ***
Create by Rockwell Chuang 10/01/2005.

Usage:
      BS [ 1 | 2 | 3 | 4 ]

BS 1 : [ Floppy ] => [ HardDisk ] => [ CD-ROM ] => [ LAN   ]
BS 2 : [ HardDisk ] => [ CD-ROM ] => [ LAN   ] => [ Floppy ]
BS 3 : [ CD-ROM ] => [ HardDisk ] => [ LAN   ] => [ Floppy ]
BS 4 : [ LAN   ] => [ Floppy ] => [ HardDisk ] => [ CD-ROM ]

d:\BOOTSEQ>
```

3. Select the desired boot sequence by entering the corresponding sequence, for example, enter BS2 to change the boot sequence to HDD|CD ROM|LAN|Floppy.

Using DMITools

The DMI (Desktop Management Interface) Tool copies BIOS information to eeprom to be used in the DMI pool for hardware management.

When the BIOS displays **Verifying DMI pool data** it is checking the table correlates with the hardware before sending to the operating system (Windows, etc.).

To update the DMI Pool, perform the following steps:

1. Enter into DOS.
2. Execute **dmitools.exe**. The following messages show dmitools usage:
DMITTOOLS [/R | /WP | /WS | /WU] [STRING]
 - dmitools /r ==> Read dmi string from bios
 - dmitools /wm xxxx ==> Write manufacturer name to eeprom
 - dmitools /wp xxxx ==> Write product name to eeprom
 - dmitools /ws xxxx ==> Write serial number to eeprom
 - dmitools /wu xxxx ==> Write uuid to eeprom
 - dmitools /wa xxxx ==> Write asset tag to eeprom

IMPORTANT:The following write examples (2 to 5) require a system reboot to take effect

Example 1: Read DMI Information from Memory

Input:

```
dmitools /r
```

Output:

```
Manufacturer (Type1, Offset04h): Acer  
Product Name (Type1, Offset05h): Aspire one xxxxx  
Serial Number (Type1, Offset07h): 01234567890123456789  
UUID String (Type1, Offset08h): xxxxxxxx-xxxx-xxxx-xxxx-xxxxxxxxxxxx  
Asset Tag (Type3, Offset04h): Acer Asstag
```

Example 2: Write Product Name to EEPROM

Input:

```
dmitools /wp Acer
```

Example 3: Write Serial Number to EEPROM

Input:

```
dmitools /ws 01234567890123456789
```

Example 4: Write UUID to EEPROM (Create UUID from Intel WFM20.pdf)

Input:

```
dmitools /wu
```

Example 5: Write Asset Tag to EEPROM

Input:

```
dmitools /wa Acer Asstag
```

Using the LAN MAC Utility

Perform the following steps to write MAC information to eeprom:

1. Use a text editor, for example Notepad, to edit the MAC.CFG file as shown:



```
MAC.CFG - 0000000000000000
Title= MAC Address byte
WriteData='001122334455'
StartAddr=7A
WriteLeng=6
KeepByte=0
```

- WriteData= '001122334455' <----- MAC value
 - StartAddr=7A <----- MAC address
 - WriteLeng=6 <----- MAC value length
 - KeepByte=0 <----- can be any value
2. Boot into DOS.
3. Execute **MAC.BAT** to write MAC information to eeprom.

```
C:\MAC>mac.bat  
C:\MAC>eeprom w MAC.cfg  
Progress --> \  
Write Data to EEPROM OK!!
```

Machine Disassembly and Replacement

This chapter contains step-by-step procedures on how to disassemble the notebook computer for maintenance and troubleshooting.

Disassembly Requirements

To disassemble the computer, you need the following tools:

- Wrist grounding strap and conductive mat for preventing electrostatic discharge
- Flat screwdriver
- Philips screwdriver
- Plastic flat screwdriver
- Plastic tweezers

NOTE: The screws for the different components vary in size. During the disassembly process, group the screws with the corresponding components to avoid mismatch when putting back the components.

Related Information

The product previews seen in the disassembly procedures may not represent the final product color or configuration.

IMPORTANT: Cable paths and positioning may not represent the actual model. During the removal and replacement of components, ensure all available cable channels and clips are used and that the cables are replaced in the same position.

General Information

Pre-disassembly Instructions

Before proceeding with the disassembly procedure, make sure that you do the following:

1. Turn off the power to the system and all peripherals.
2. Unplug the AC adapter and all power and signal cables from the system.



3. Place the system on a flat, stable surface.
4. Remove the battery pack.

Disassembly Process

The disassembly process is divided into the following sections:

- External components disassembly
- Main unit disassembly
- LCD module disassembly

The flowcharts provided in the succeeding disassembly sections illustrate the entire disassembly sequence. Observe the order of the sequence to avoid damage to any of the hardware components. For example, if you want to remove the Mainboard, you must first remove the Keyboard, and LCD Module then disassemble the inside assembly frame in that order.

Main Screw List

Screw	Quantity	Part Number
M2*5-I(BZN)(NYLOK)		86.TG607.004
M2.0*2.5-I(BUWZN)		86.TPK07.001
M2.0*3.0-I-NI-NYLOK IRON S.P		TBD
M2.0*5.0-I(NI)		86.S0207.002
M3*0.5+3.5I IRON S.P		TBD
M2.0*2,I,NI,NYLOK IRON S.P		TBD

External Module Disassembly Process

NOTE: The product previews seen in the disassembly procedures may not represent the final product color or configuration.

External Modules Disassembly Flowchart

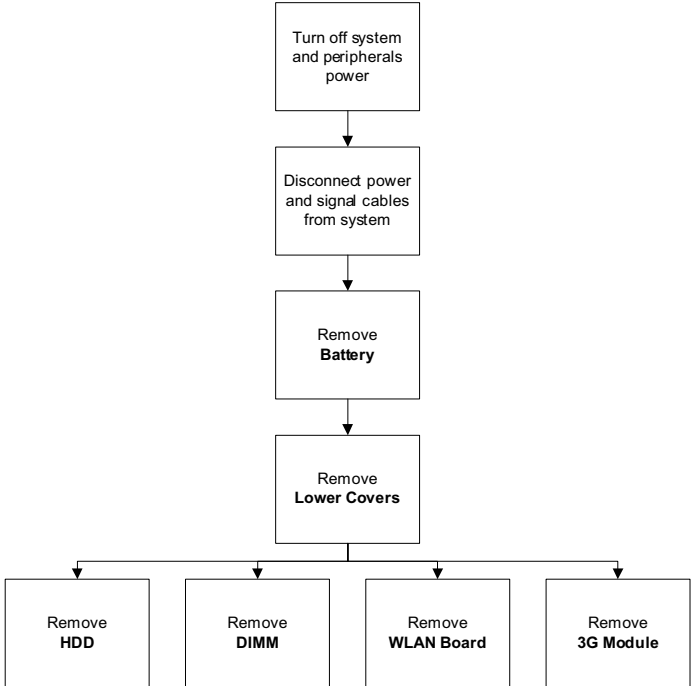

Screw List

Step	Screw	Quantity	Part No.
HDD Carrier	M3*3	4	TBD
WLAN Board	M2*3	1	TBD
3G Module	M2*3	1	TBD

Removing the Battery Pack

1. Turn the computer over.
2. Slide the battery lock/unlock latch to the unlock position.



3. Slide and hold the battery release latch to the release position (1), then slide out the battery pack from the main unit (2).

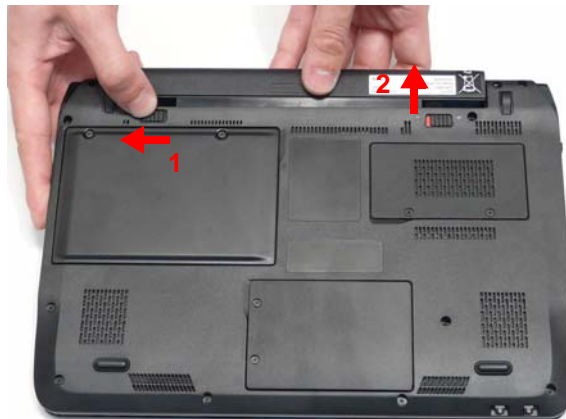

Removing the Lower Covers

1. See "Removing the Battery Pack" on page 44.
2. Loosen the six captive screws in the HDD, Memory, and 3G Covers.

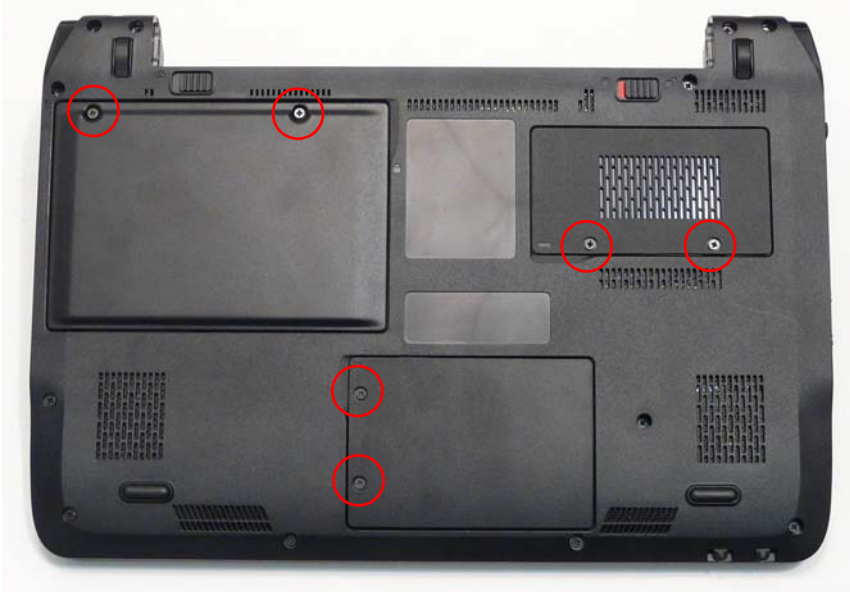

3. Lift the HDD cover up to remove.



4. Lift the Memory cover up to remove.



5. Lift the 3G cover up to remove.



Removing the Hard Disk Drive Module

1. See “Removing the Lower Covers” on page 45.
2. Remove the single screw securing the HDD Module in place.



3. Slide the HDD in the direction of the arrow to disconnect the HDD from the interface connector.

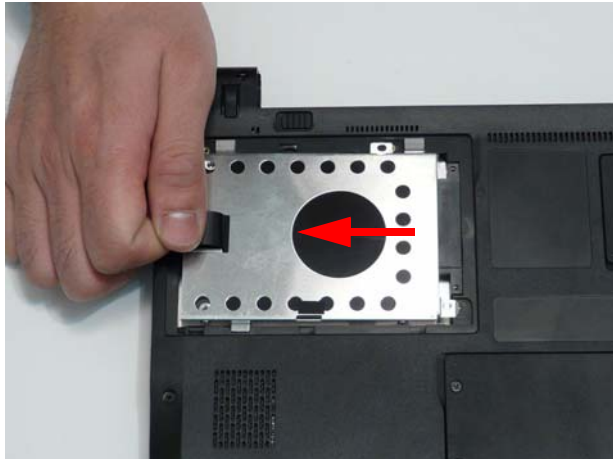

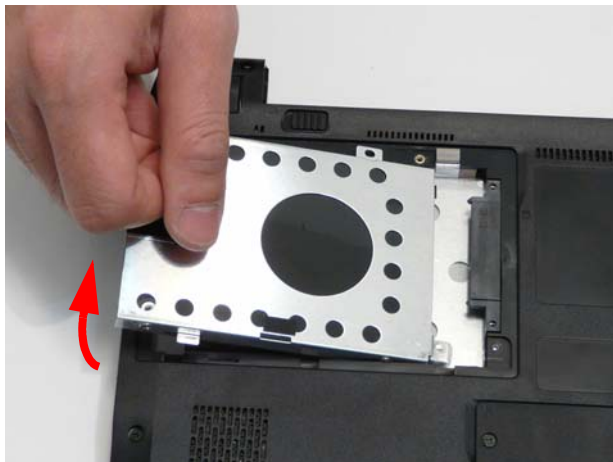

4. Lift the hard disk drive module out of the bay.

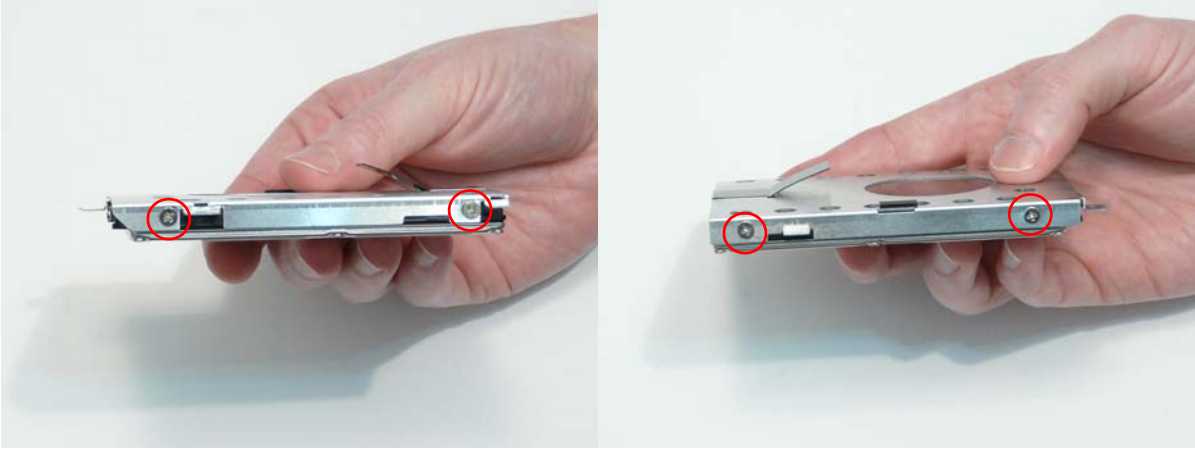

NOTE: To prevent damage to device, avoid pressing down on it or placing heavy objects on top of it.

5. Remove the four screws (two each side) securing the hard disk to the carrier.



Step	Size	Quantity	Screw Type
HDD Carrier	M3*3	4	

6. Remove the HDD from the carrier.

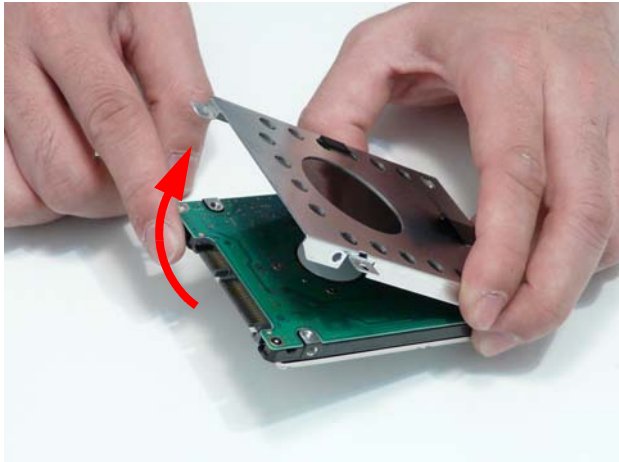

Removing the DIMM Module

1. See "Removing the Lower Covers" on page 45.
2. Push out the release latches on both sides of the DIMM socket to release the DIMM module.



3. Remove the DIMM module.



Removing the WLAN Board

1. See "Removing the Lower Covers" on page 45.
2. Disconnect the Antenna cables from the WLAN Board.
NOTE: Cable placement is Black to the MAIN terminal (right) and White to the AUX terminal (left).



3. Remove the single screw securing the WLAN Board in place.



Step	Size	Quantity	Screw Type
WLAN Board	M2*3	1	

4. Remove the WLAN Board from the Mainboard.



Removing the 3G Module

IMPORTANT: 3G functionality is not supported by all models.

1. See "Removing the Lower Covers" on page 45.
2. Disconnect the 3G Antenna cables from the 3G Module.

IMPORTANT: The Blue cable attaches to the MAIN terminal (left) and the Yellow cable attaches to the AUX terminal (right).



3. Move the antenna away and remove the single screw from the 3G Module.



Step	Size	Quantity	Screw Type
3G Module	M2*3	1	

-
4. Detach the 3G Module from the socket.



NOTE: When reattaching the antennas, ensure the cables are tucked into the chassis to prevent damage.

Main Unit Disassembly Process

IMPORTANT: Cable paths and positioning may not represent the actual model. During the removal and replacement of components, ensure all available cable channels and clips are used and that the cables are replaced in the same position.

NOTE: The product previews seen in the disassembly procedures may not represent the final product color or configuration.

Main Unit Disassembly Flowchart

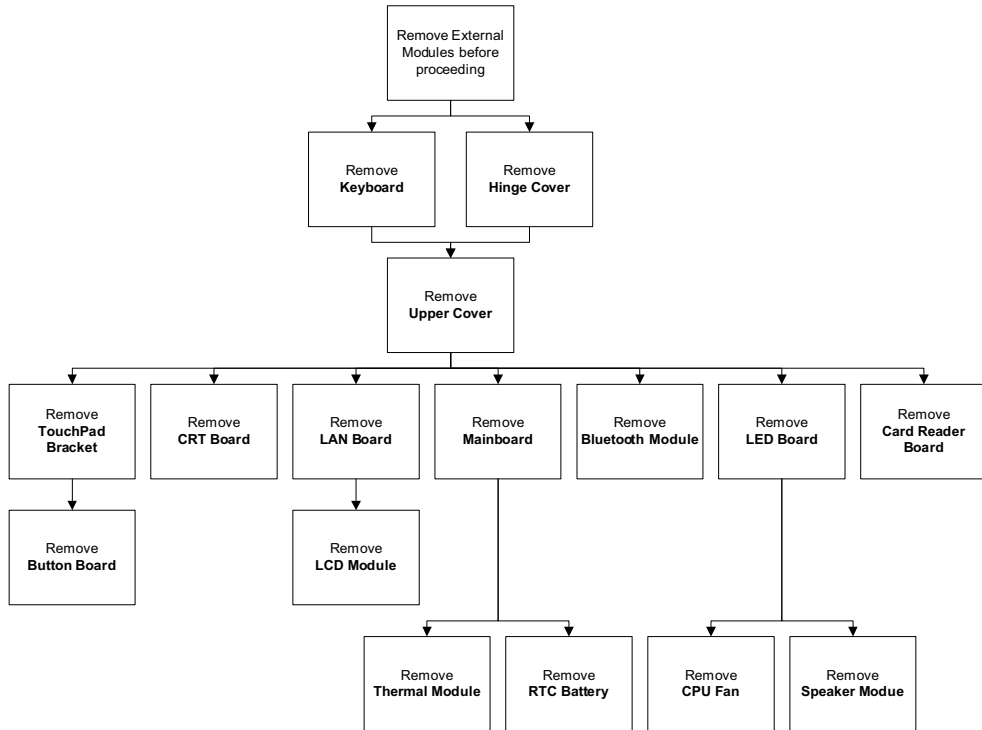

Screw List

Step	Screw	Quantity	Part No.
Hinge Covers	M2*5	4	86.TG607.004
Upper Cover	M2*5	24	86.TG607.004
	M2*3	2	TBD
	M2*2.5	5	86.TPK07.001
TouchPad Bracket	M2*3	3	TBD
Card Reader Board	M2*5	1	86.TG607.004
CRT Board	M2*5	1	86.TG607.004
LAN Board	M2*5	1	86.TG607.004
LCD Module	M2*3	2	TBD
	M2*5	3	86.S0207.002
LED Board	M2*5	1	86.S0207.002
CPU Fan	M2*3	3	TBD
Speaker Module	M2*3	3	TBD
Mainboard	M2*5	1	86.S0207.002
Thermal Module	M2*2	3	TBD

Removing the Keyboard

1. See "Removing the Battery Pack" on page 44.
2. Turn the computer rightside up and open the lid to the full extent.
3. Unlock the four securing latches by pressing down with a suitable plastic tool.

IMPORTANT: The use of metal tools may damage the outer casing. Use plastic tools where available.



4. Lift the Keyboard away from the Upper Cover as shown.

IMPORTANT: Do not remove the Keyboard from the Upper Cover; the Keyboard FFC is still attached.



5. Turn the Keyboard over and open Keyboard FFC securing latch as shown.



6. Disconnect the FFC and remove the Keyboard.



Removing the Hinge Covers

1. See "Removing the Battery Pack" on page 44.
2. Turn the computer over. Remove the four screws securing the Hinge Covers to the Lower Cover.



Step	Size	Quantity	Screw Type
Hinge Covers	M2*5	4	



3. Lift the Hinge Covers away from the Upper Cover as shown.

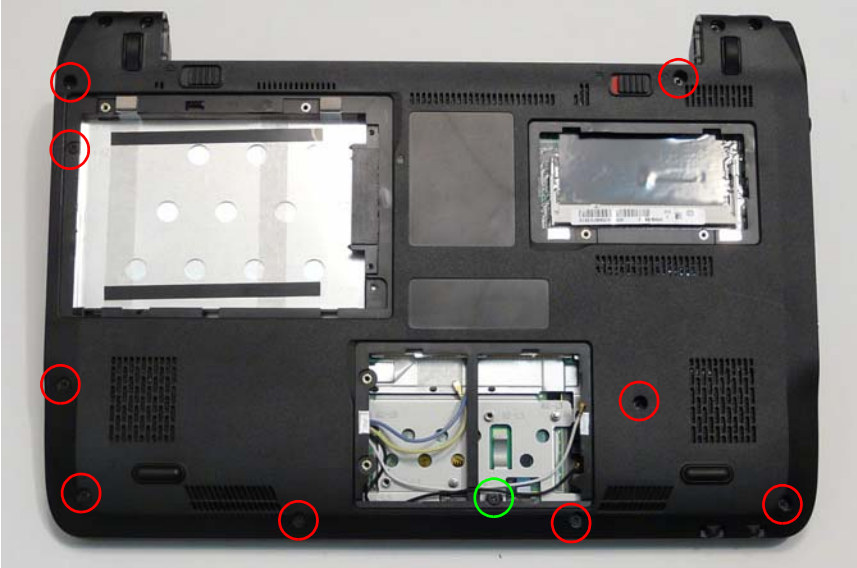

Removing the Upper Cover

1. See "Removing the Keyboard" on page 55.
2. Remove the ten screws securing the Upper Cover to the Lower Cover.



Step	Size	Quantity	Screw Type
Upper Cover (red callouts)	M2*5	9	
Upper Cover (green callouts)	M2*3	1	

3. Turn the computer over and disconnect the following cable from the Mainboard.

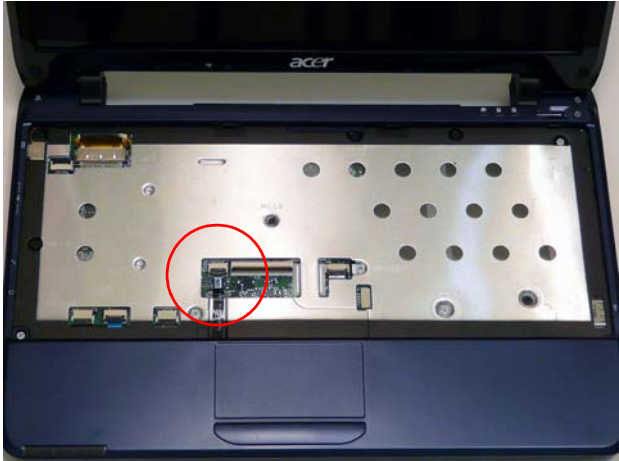

Release the locking latch as shown.

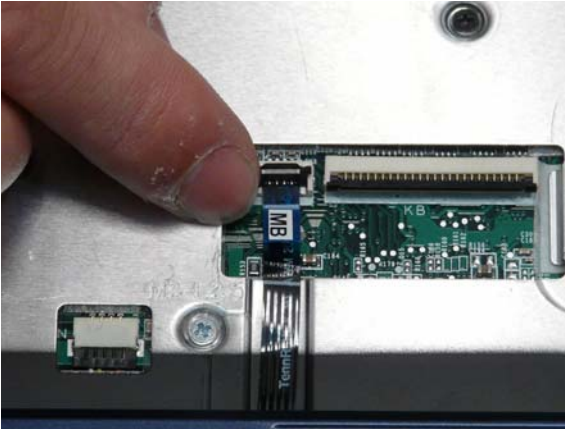



Disconnect the FFC as shown.

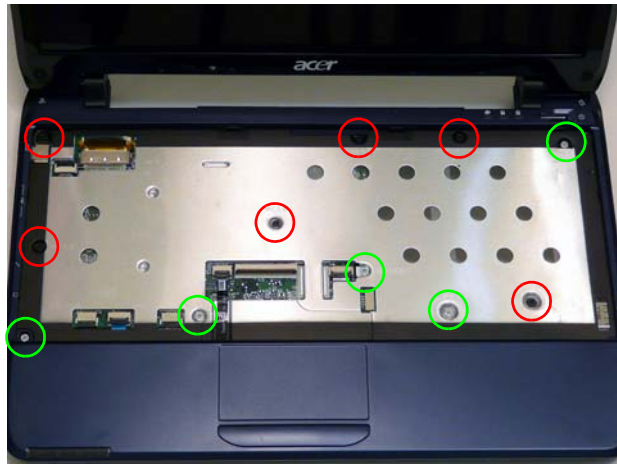

4. Remove the eleven securing screws from the Upper Cover.



Step	Size	Quantity	Screw Type
Upper Cover (red callout)	M2*5	6	
Upper Cover (green callout)	M2*2.5	5	

5. Starting at the front the cover, pry apart the Upper and Lower Covers as shown.



6. Working along the front to the left and right, pry apart the covers as shown.

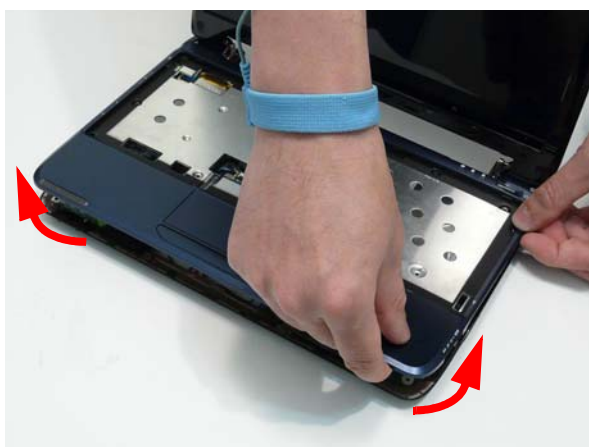

7. Lift the Upper Cover clear of the Lower Cover.



Removing the TouchPad Bracket and Button Board

IMPORTANT: The TouchPad Board cannot be removed individually. To replace the TouchPad Board, replace the entire Upper Cover.

1. See "Removing the Upper Cover" on page 58.
2. Open the locking latches and disconnect the two FFCs from the Button Board as shown.

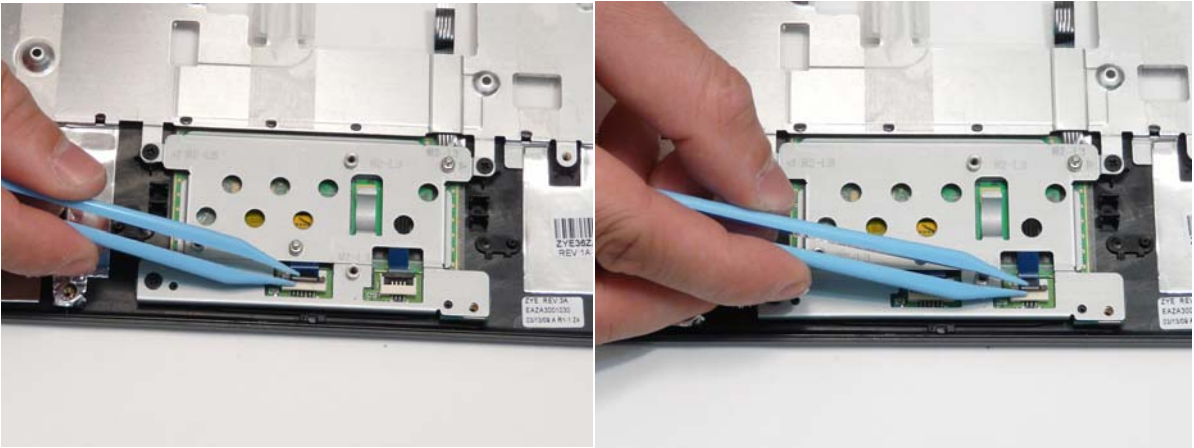

3. Remove the three screws securing the TouchPad Bracket to the Upper Cover.

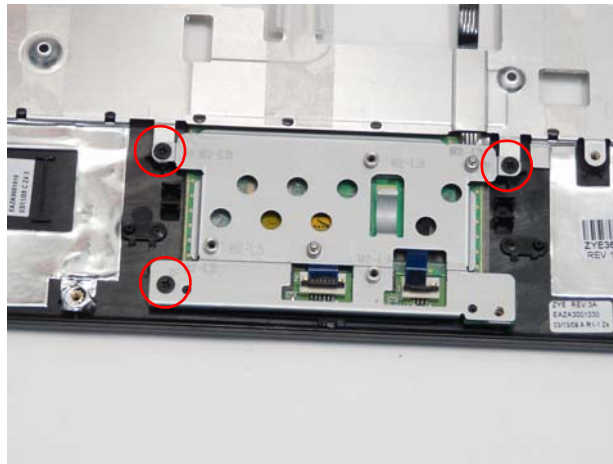

Step	Size	Quantity	Screw Type
TouchPad Bracket	M2*3	3	

IMPORTANT: Ensure that the FFCs are disconnected before attempting to remove the TouchPad Bracket.

4. Lift the TouchPad Bracket away from the Upper Cover as shown.

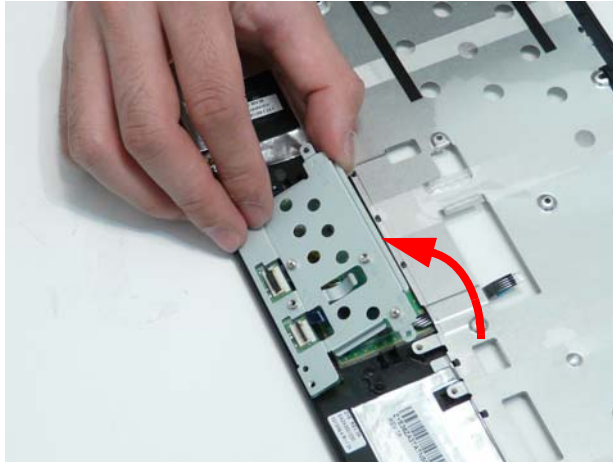

5. Turn the TouchPad Bracket over and remove the Button Board from the bracket.

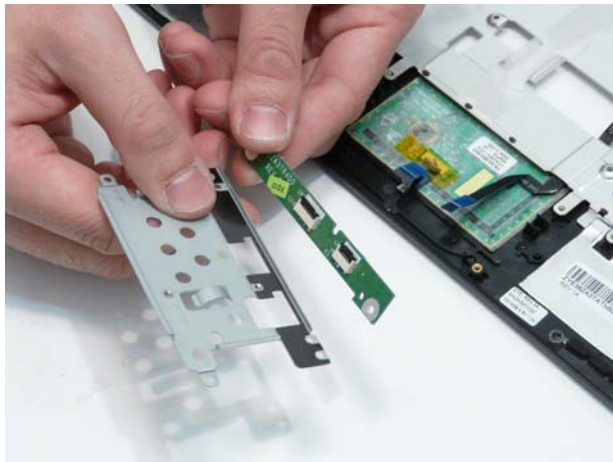

6. Remove the adhesive strip securing the TouchPad FFC in place.



7. Open the FFC locking latch and disconnect the FFC from the TouchPad connector.

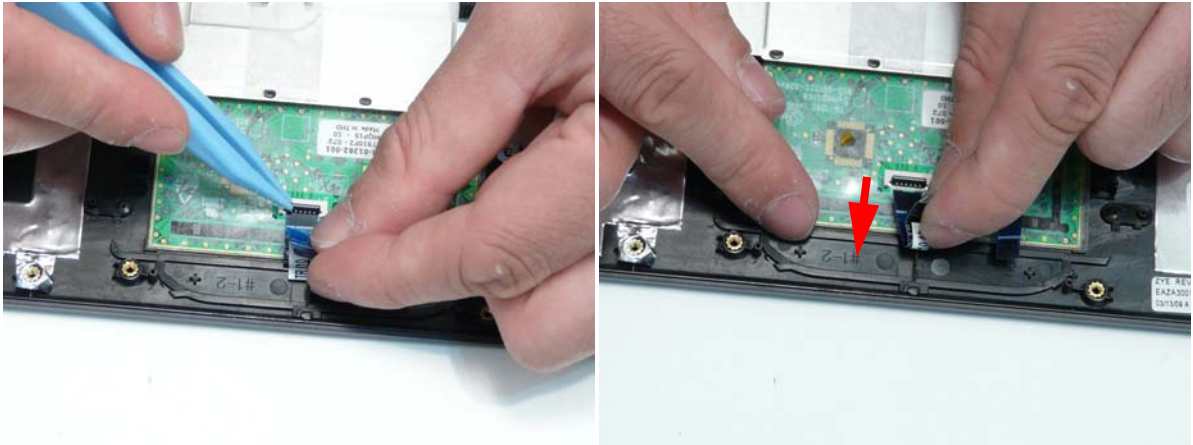

8. Turn the Upper Cover over and push the FFC through the cover as shown.



9. Turn the Upper Cover over and pull the FFC through the cover as shown.
IMPORTANT: Ensure that the FFC pull tab is not torn off during removal.



Removing the Card Reader Board

1. See "Removing the Upper Cover" on page 58.
2. Open the locking latch and disconnect the FFC from the Card Reader Board.



3. Open the locking latch and disconnect the FFC from the Mainboard.

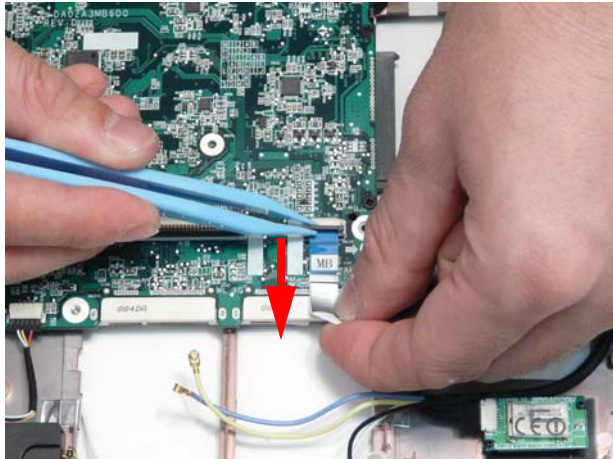

4. Remove the single screw securing the Card Reader Board to the Lower Cover.



Step	Size	Quantity	Screw Type
Card Reader Board	M2*5	1	

5. Remove the board from the Lower Cover, left side first to release the I/O ports.

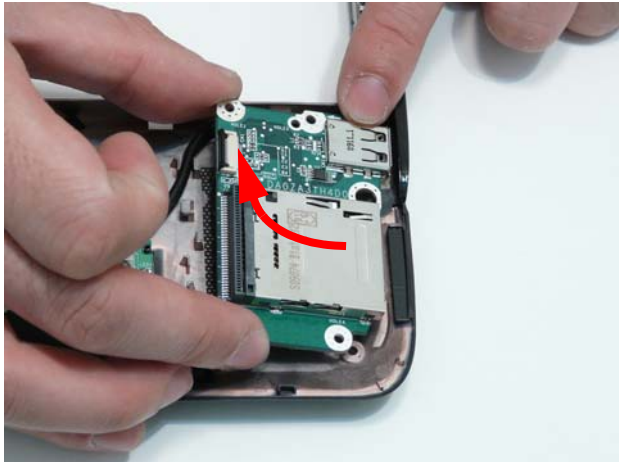

Removing the CRT Board

1. See "Removing the Upper Cover" on page 58.
2. Remove the single screw securing the CRT Board to the Lower Cover.



Step	Size	Quantity	Screw Type
CRT Board	M2*5	1	

3. Lift the CRT Board left side first and turn it over to expose the CRT cable.
- IMPORTANT:** Do not remove the board from the Lower Cover; the CRT cable is still attached.



4. Disconnect the cable from the CRT Board and remove the board from the Lower Cover.



Removing the LAN Board

1. See "Removing the Upper Cover" on page 58.
2. Lift the adhesive strip securing the LVDS cable in place and disconnect the cable from the Mainboard.

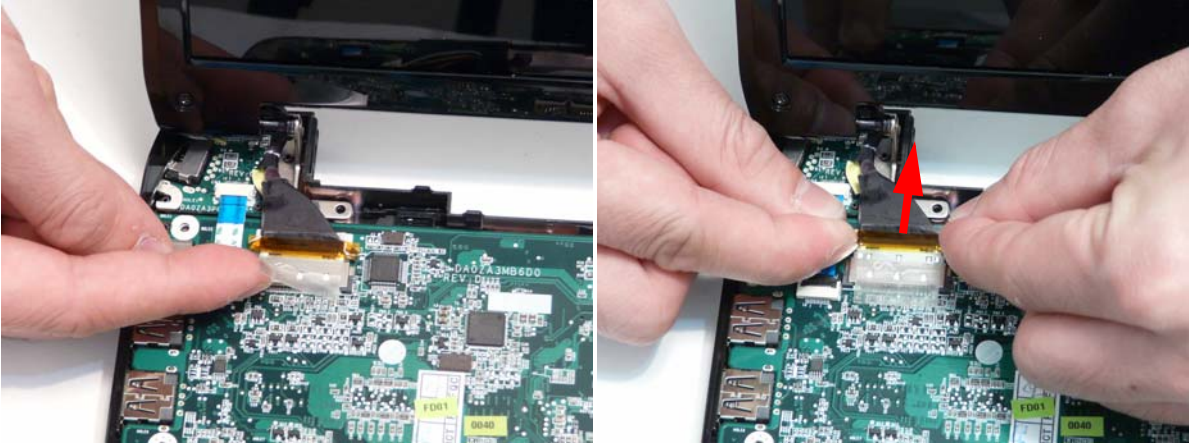

3. Disconnect the FFC cable from the LAN Board by pulling on the cable tab as shown.
NOTE: This FFC connector does not use a cable latch to secure the FFC in place.

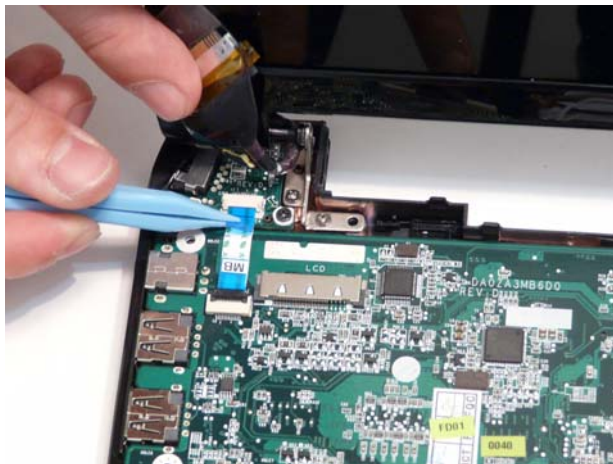

4. Open the FFC locking latch and disconnect the LAN Board cable from the Mainboard.

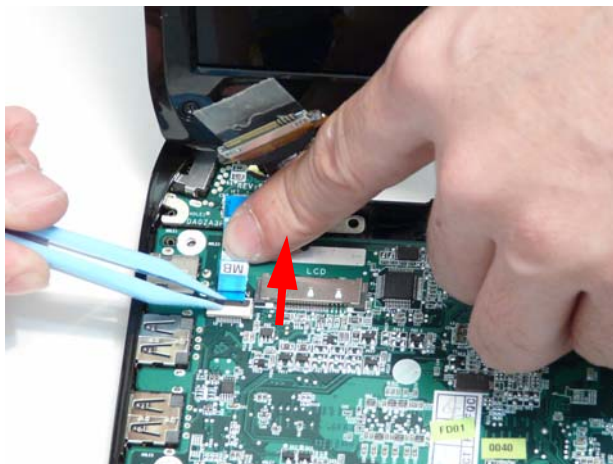

5. Remove the single screw securing the LAN Board to the Lower Cover.



Step	Size	Quantity	Screw Type
LAN Board	M2*5	1	

6. Push the RJ-45 connector through the Lower Cover as shown and remove the LAN Board from the computer.

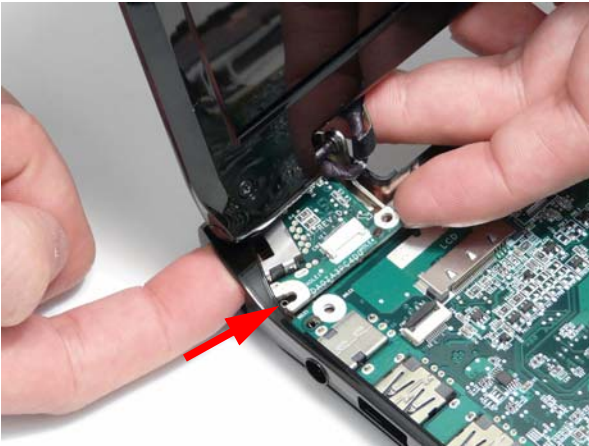

Removing the LCD Module

1. See "Removing the CRT Board" on page 66.

NOTE: It is not necessary to remove the LAN Board before removing the LCD Module.

2. Lift the adhesive strip securing the LVDS cable in place and disconnect the cable from the Mainboard.

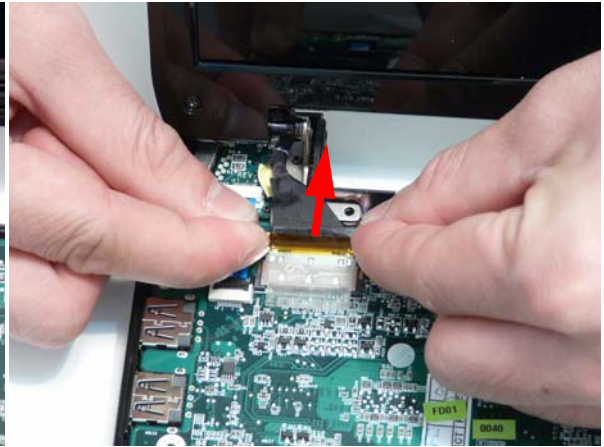

3. Remove the Antenna cables from the cable channel on the Lower Cover as shown, all the way to the hinge well.

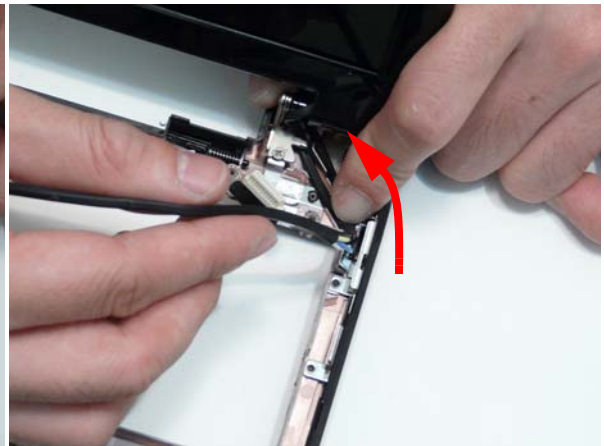
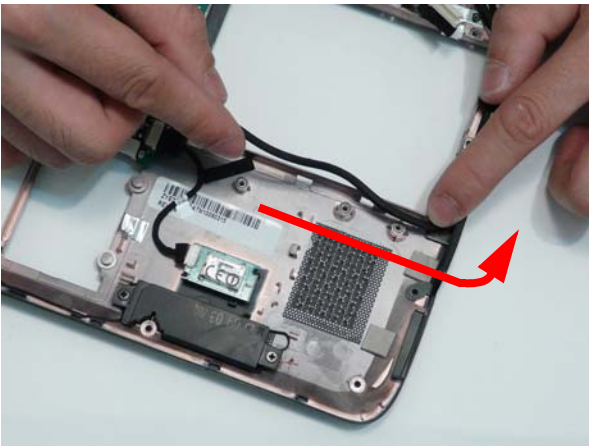

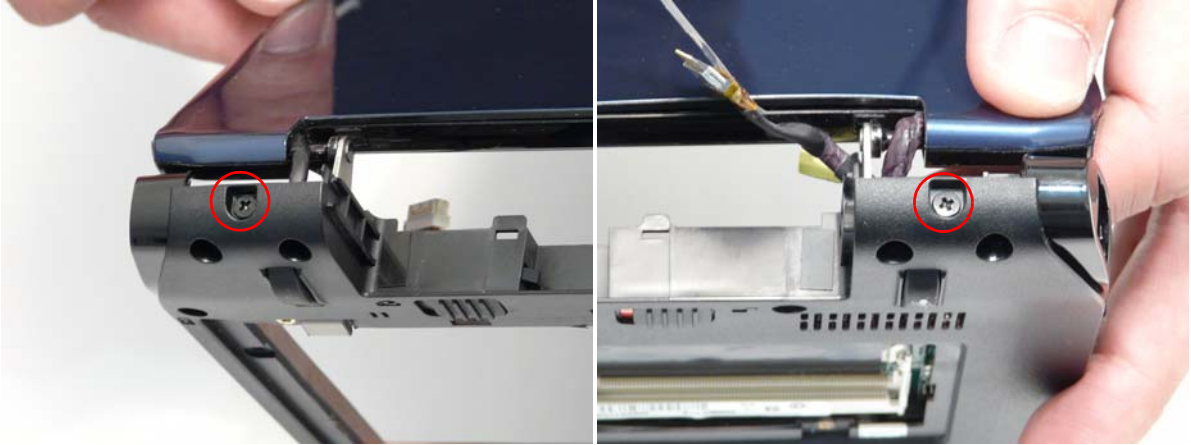

4. Remove the two screws on the rear of the Lower Cover securing the LCD Module to the computer.

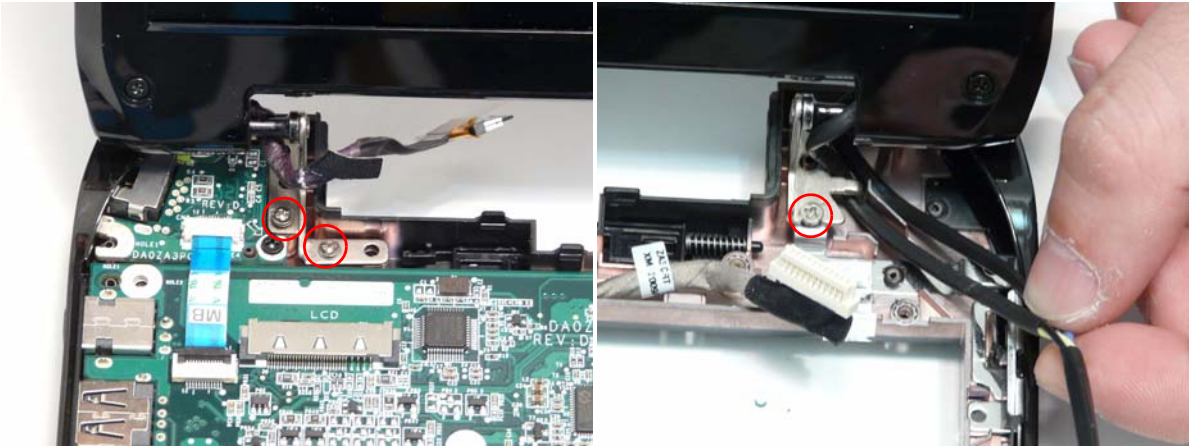

Step	Size	Quantity	Screw Type
LCD Module	M2*3	2	

5. Remove the three screws (two on the left hinge and one on the right) securing the LCD Module to the Lower Cover.



Step	Size	Quantity	Screw Type
LCD Module	M2*5	3	

IMPORTANT: Ensure that the LCD cables are free from all cable clips before removing the LCD Module.

6. Using both hands, lift the LCD Module away from the Lower Cover.

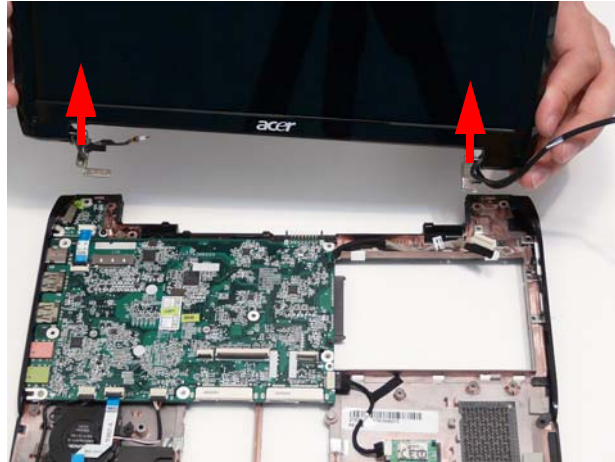

Removing the Bluetooth Module

1. See "Removing the Upper Cover" on page 58.
2. Disconnect the Bluetooth cable from the Mainboard.

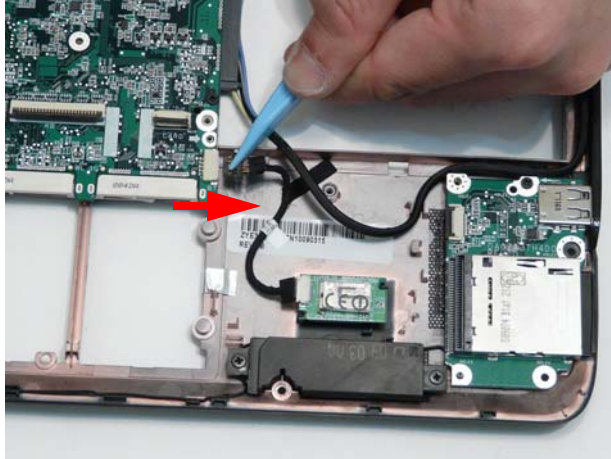

3. Lift the adhesive strip to detach the cable from the Lower Cover.

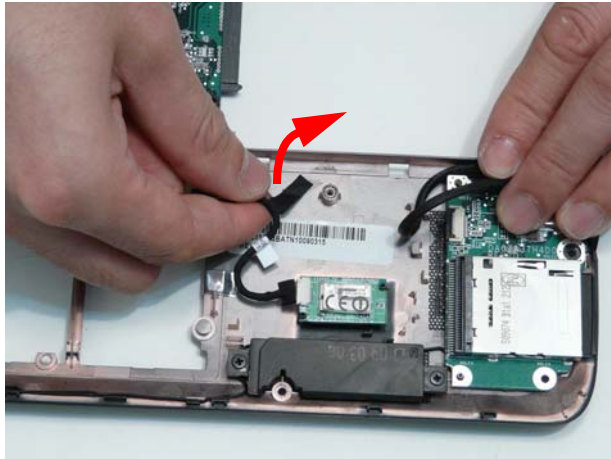

4. Disconnect the cable from the Bluetooth Module.

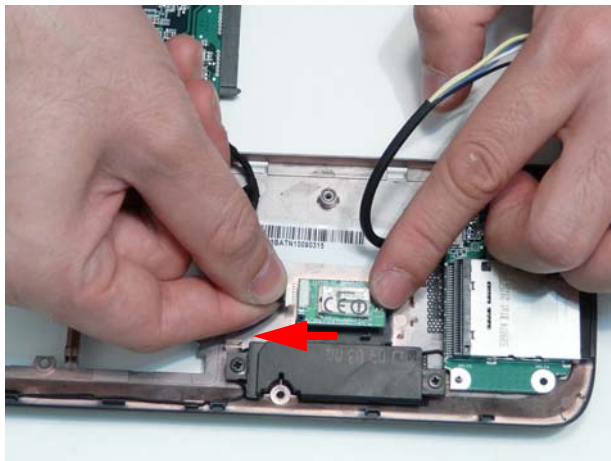

5. Lift the Bluetooth Module, left side first, to remove it from the Lower Cover.

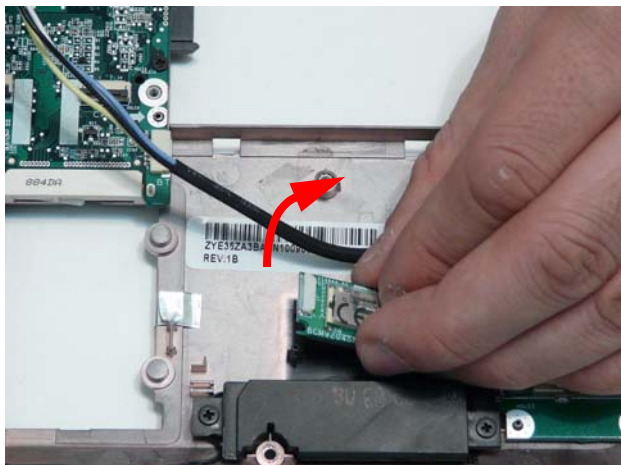

Removing the LED Board

1. See "Removing the Upper Cover" on page 58.
2. Open the locking latch and disconnect the LED Board FFC from the Mainboard.

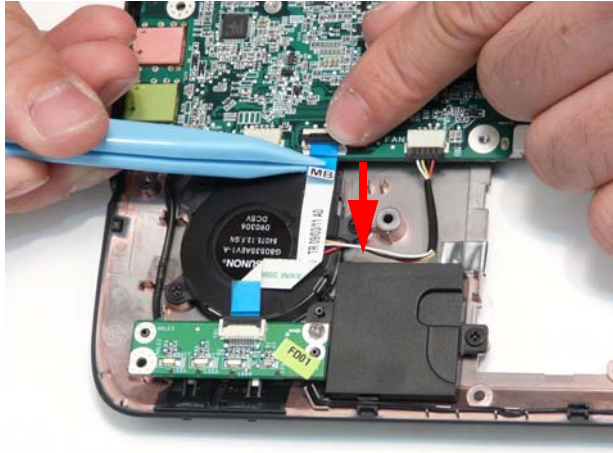

3. Open the locking latch and disconnect the FFC from the LED Board.

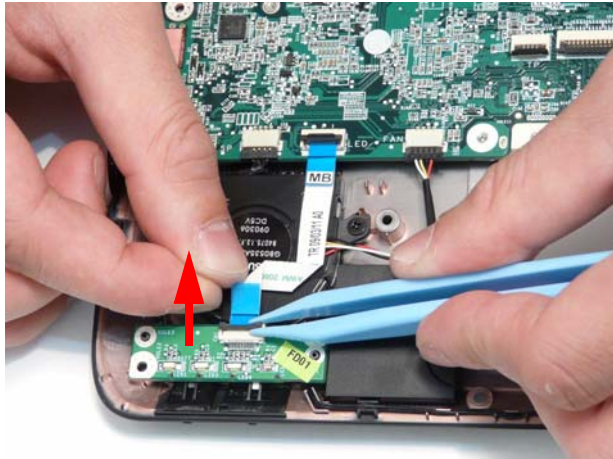

4. Remove the single screw securing the LED Board to the Lower Cover.



Step	Size	Quantity	Screw Type
LED Board	M2*5	1	

5. Lift the LED Board from the Lower Cover.

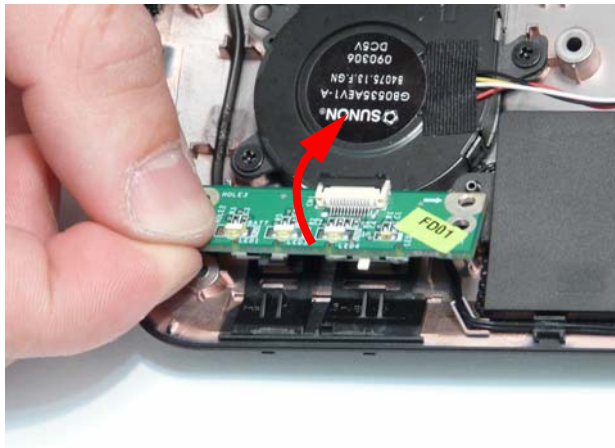

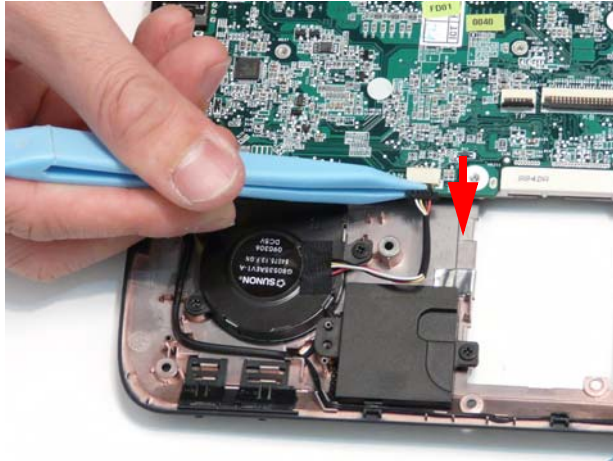

Removing the CPU Fan

1. See "Removing the LED Board" on page 75.
2. Disconnect the fan power cable from the Mainboard.

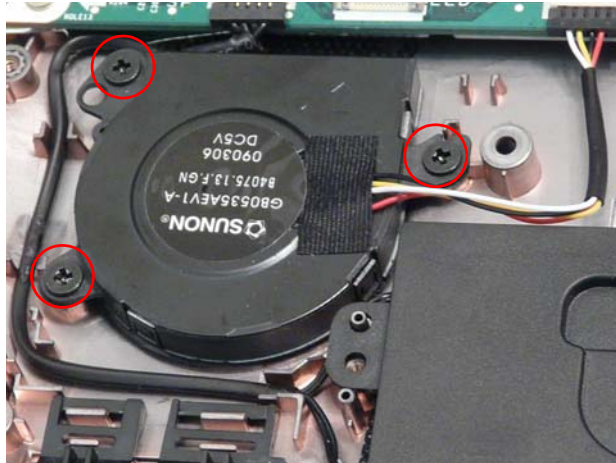

3. Remove the three screws securing the CPU Fan to the Lower Cover.



Step	Size	Quantity	Screw Type
CPU Fan	M2*3	3	

4. Lift the CPU Fan clear of the Lower Cover.

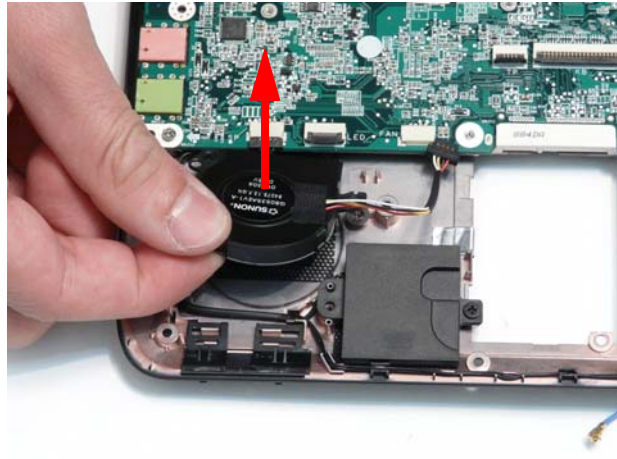

Removing the Speaker Module

1. See "Removing the CPU Fan" on page 77.
2. Disconnect the Speaker cable from the Mainboard.



3. Remove the Speaker cable from the cable channel. Ensure that the cable is free from all cable clips.

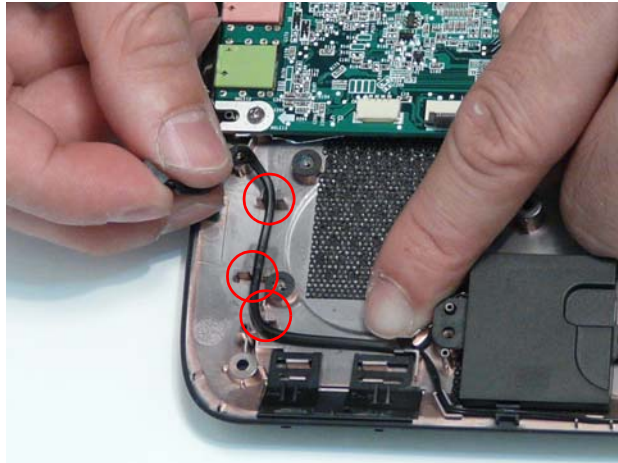

- Remove the three screws securing the Speakers to the Lower Cover.

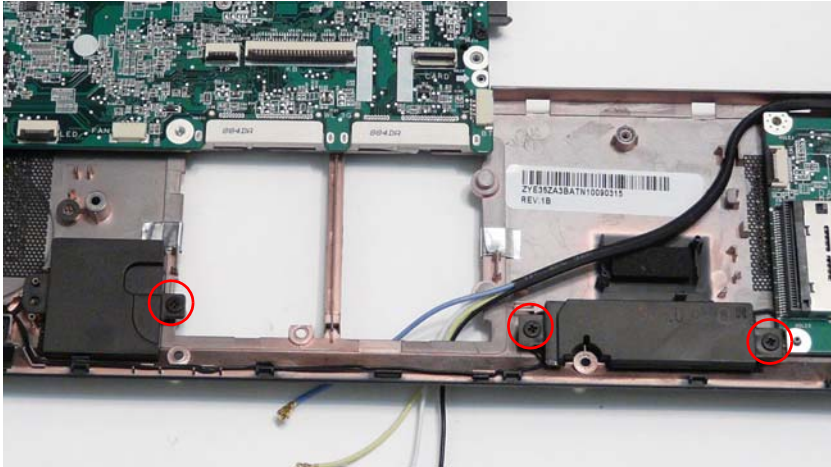

Step	Size	Quantity	Screw Type
Speaker Module	M2*3	3	

- Lift the left side speaker from the Lower Cover as shown.

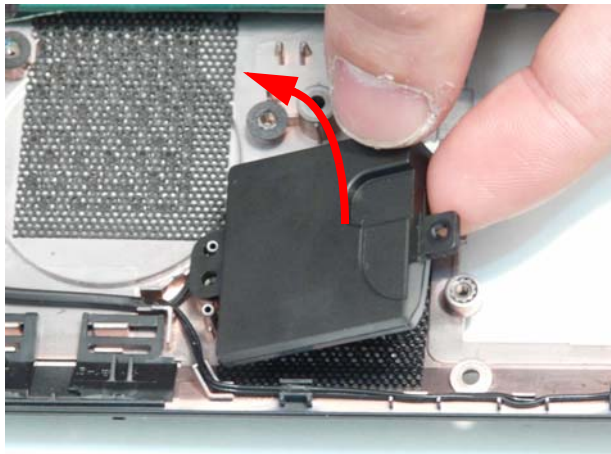

- Remove the cable from the cable channel at the front of the Lower Cover. Ensure the cable is free from all cable clips.

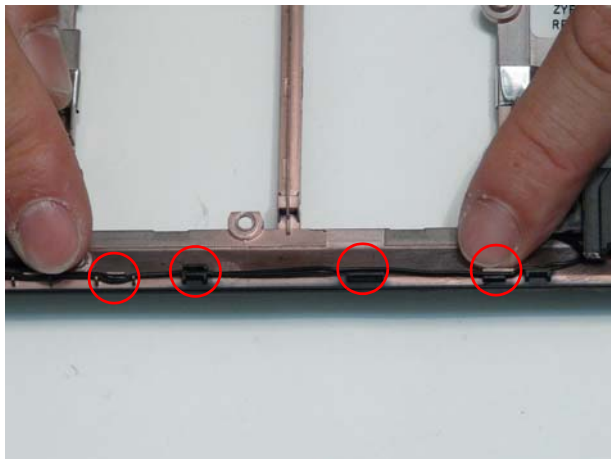

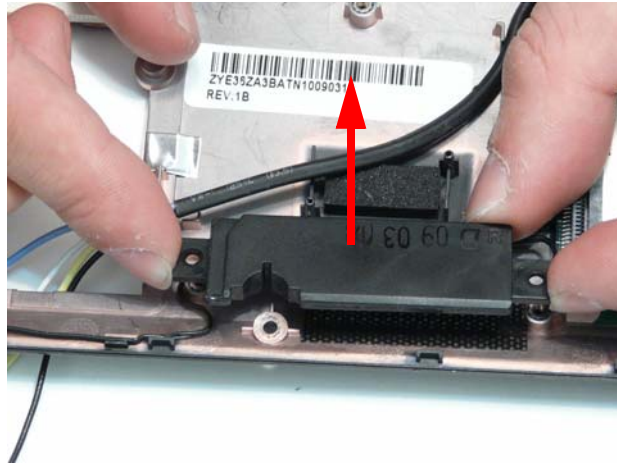

7. Lift the right side speaker from the Lower Cover as shown.

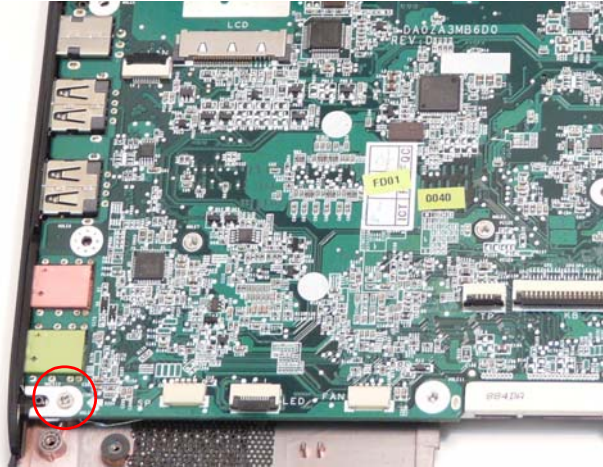

Removing the Mainboard

1. See "Removing the LED Board" on page 75.
2. Remove the single screw in the lower-left corner securing the Mainboard to the Lower Cover.



Step	Size	Quantity	Screw Type
Mainboard	M2*5	1	

3. Lift the Mainboard right side first to release the I/O ports and remove the board from the Lower Cover.

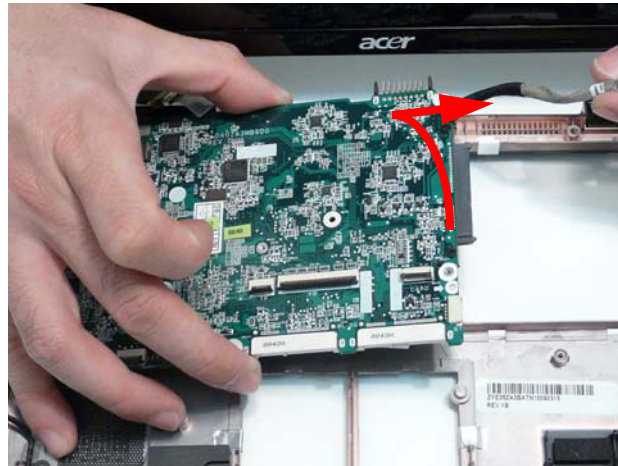

4. Turn the Mainboard over to expose the CRT cable connector. Disconnect the CRT cable as shown.

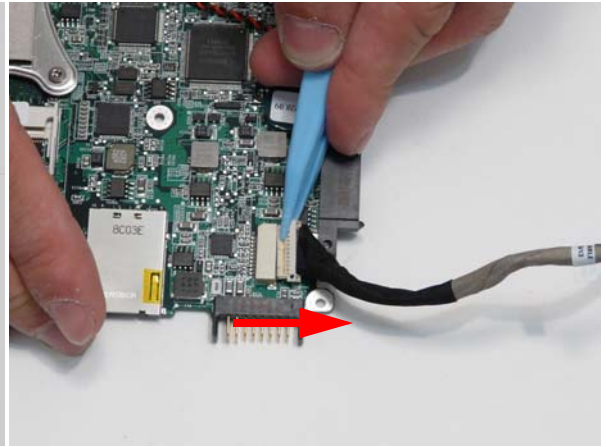
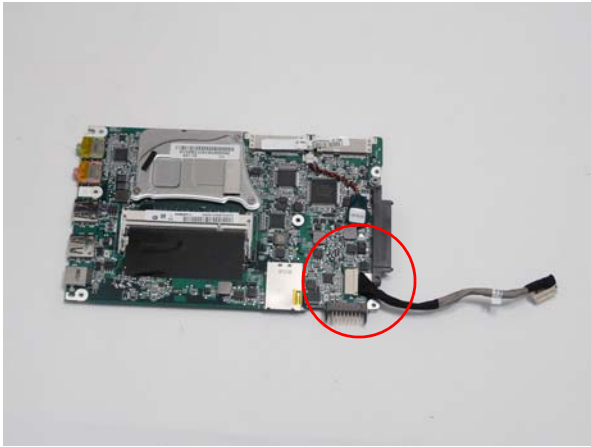

Removing the RTC Battery

IMPORTANT: Follow local regulations for disposal of all batteries.

1. See “Removing the Mainboard” on page 82.
2. Disconnect the RTC Battery as shown.

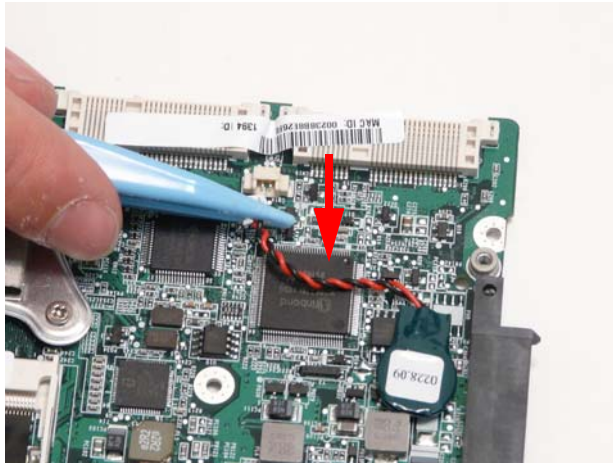

3. Lift the battery upward to detach the adhesive.

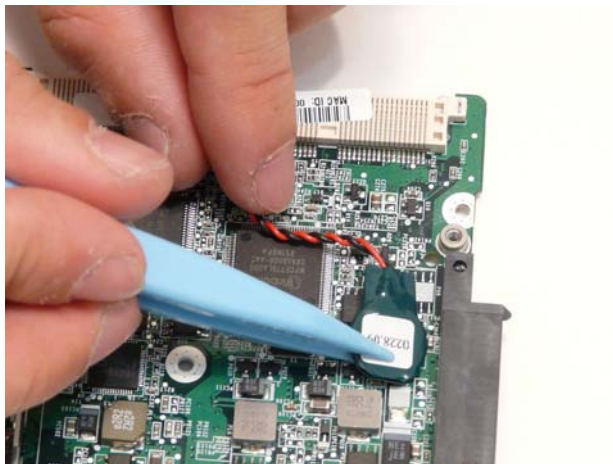



4. Attach the replacement battery to the Mainboard and connect the cable as shown.

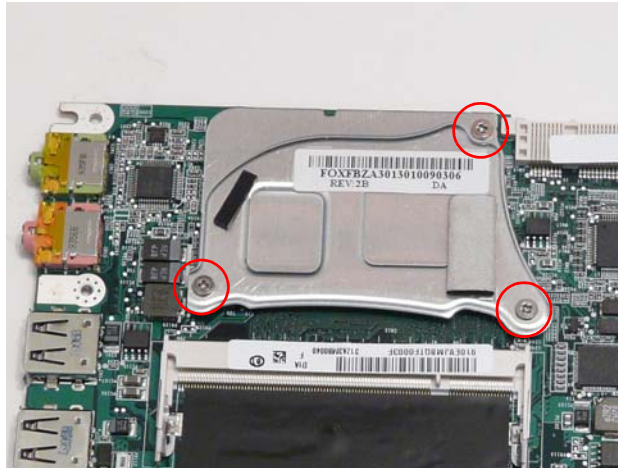

Removing the Thermal Module

1. See “Removing the Mainboard” on page 82.
2. Remove the three screws securing the Thermal Module to the Mainboard.



Step	Size	Quantity	Screw Type
Thermal Module	M2*2	3	

3. Lift the Thermal Module clear of the Mainboard.

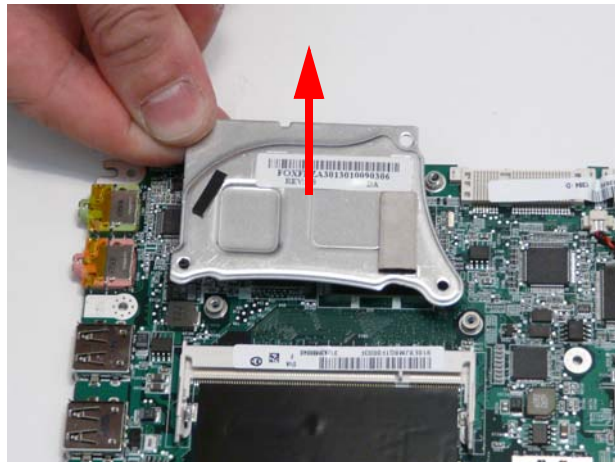

LCD Module Disassembly Process

IMPORTANT: Cable paths and positioning may not represent the actual model. During the removal and replacement of components, ensure all available cable channels and clips are used and that the cables are replaced in the same position.

NOTE: The product previews seen in the disassembly procedures may not represent the final product color or configuration. The following procedure outlines the steps to disassemble the LCD Module on models with 3G functionality. Models that do not support 3G do not require the removal of the yellow and blue Antenna cables detailed below.

LCD Module Disassembly Flowchart

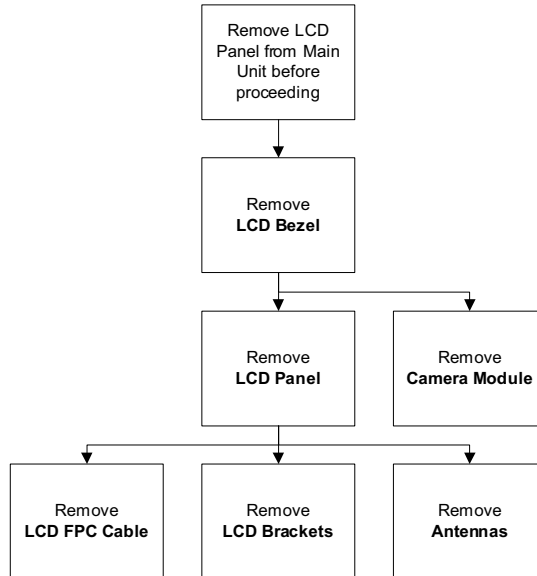

Screw List

Step	Screw	Quantity	Part No.
LCD Bezel	M2*5	6	86.TG607.004
LCD Panel	M2*2	2	TBD
LCD Brackets	M2*3	4	TBD

Removing the LCD Bezel

1. See "Removing the LCD Module" on page 70.
2. Remove the six screws securing the bezel to the LCD Module.



Step	Size	Quantity	Screw Type
LCD Bezel	M2*5	6	

3. Starting from the inside top edge, pry the bezel away from the panel. Continue moving along the top, prying the bezel away from the LCD Module. If necessary, use a plastic pry to release the corners of the bezel.



4. Work down the sides as shown, then pry apart the bottom edge to remove the bezel.



5. Lift up the bezel and remove it from the LCD Module.



Removing the Camera Board

1. See "Removing the LCD Bezel" on page 87.
2. Disconnect the cable from the Camera Board as shown.

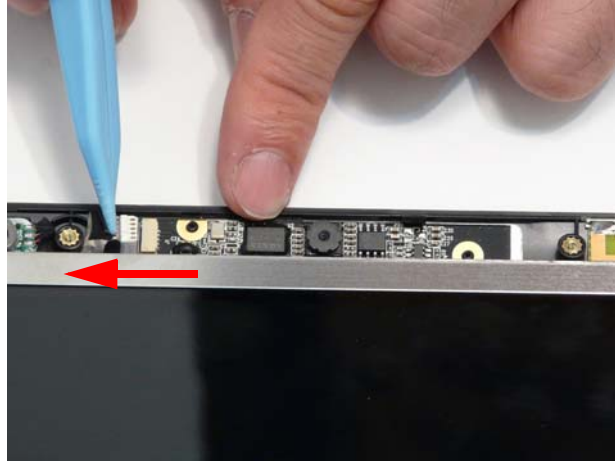

3. Remove the Camera Board from the LCD Module.

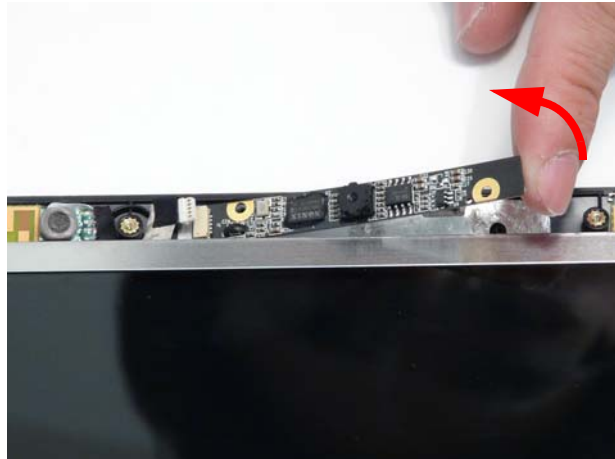

Removing the LCD Panel

1. See "Removing the Camera Board" on page 89.
2. Release the LCD cables from the hinge brackets as shown.

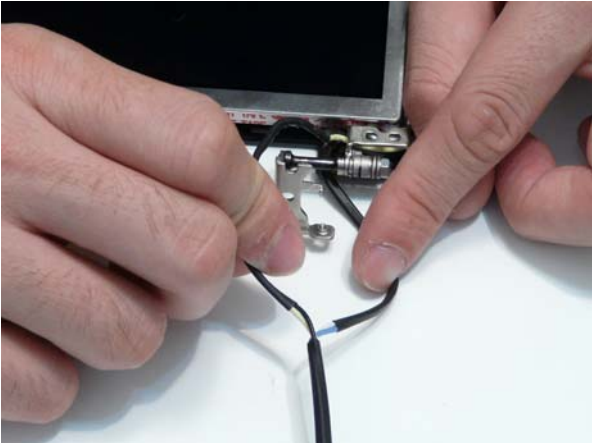

3. Lift the Microphone Module upward to detach the adhesive holding it in place.

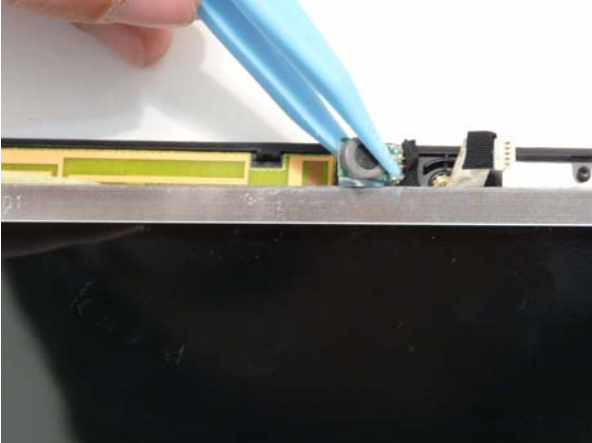

4. Remove the two screws securing the LCD Panel to the LCD Module



Step	Size	Quantity	Screw Type
LCD Panel	M2*2	2	

5. Lift the LCD Panel out of the LCD Module front edge first.



Removing the LCD Brackets and FPC Cable

1. See "Removing the LCD Panel" on page 90.
2. Remove the four securing screws (two each side) from the LCD Brackets.

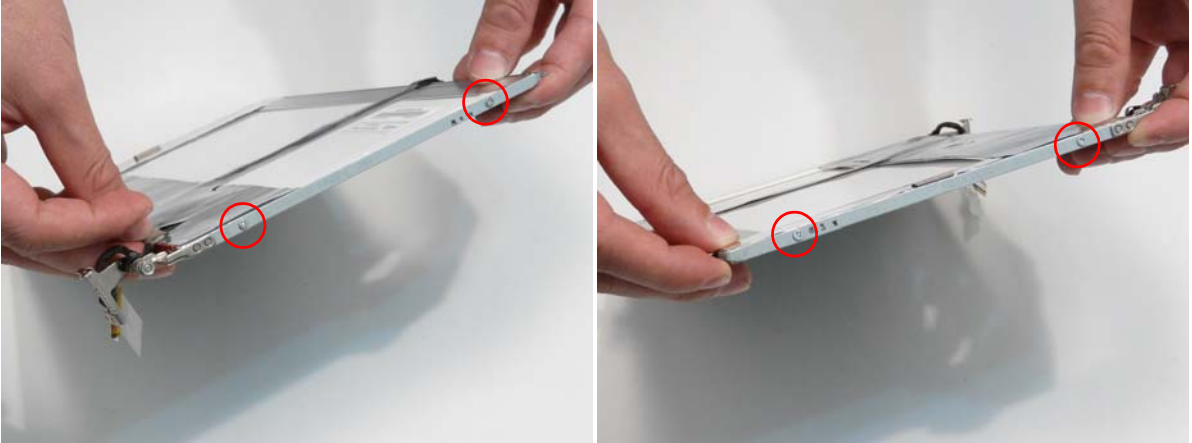

Step	Size	Quantity	Screw Type
LCD Brackets	M2*3	4	

3. Turn the LCD panel over on a clean surface. Lift the cable protection strip away from the LCD Panel to detach the adhesive securing it in place.

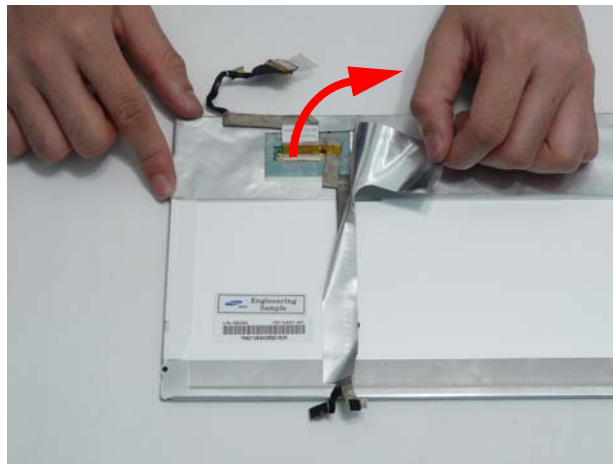

4. Lift the LCD Cable to detach the adhesive securing the cable to the LCD Panel.

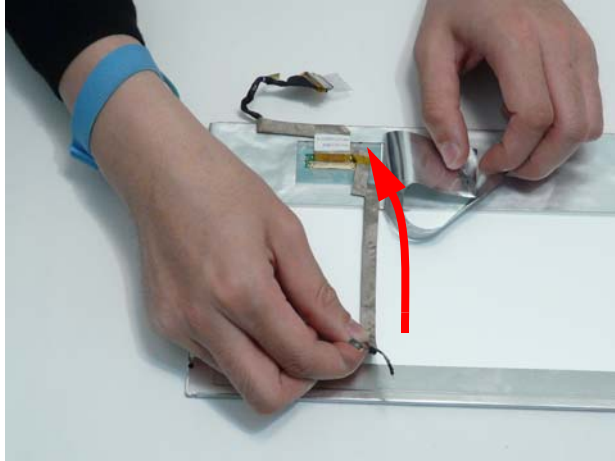

5. Carefully lift the adhesive tape securing the cable connector to the LCD Panel.

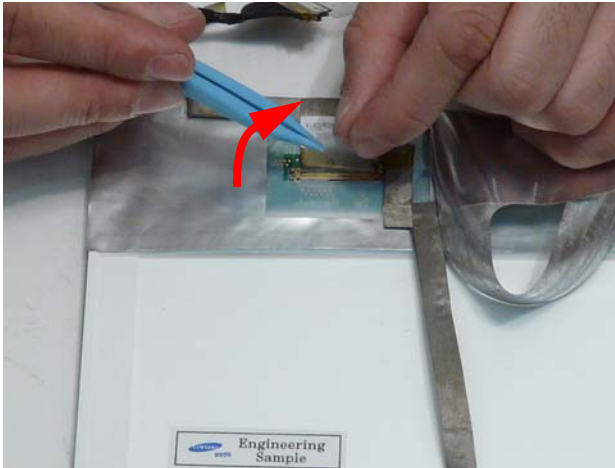

6. Hold the adhesive tape clear of the LCD Panel and disconnect the LCD cable as shown.

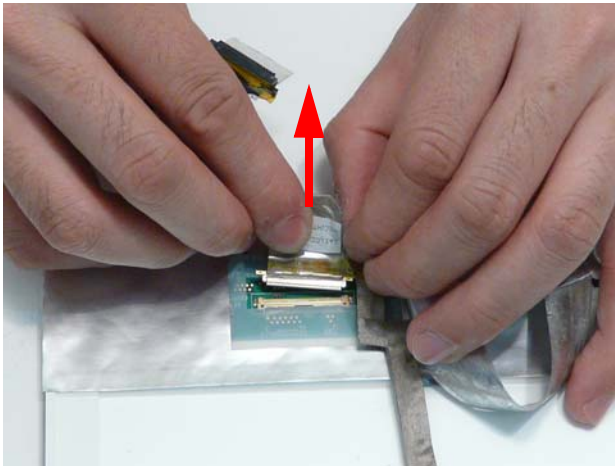

7. Remove the cable from the LCD Panel.

IMPORTANT: If the LCD Panel is replaced, remove the protective strips from the defective panel as shown and reuse them on the replacement panel. See “Replacing the LCD Cable and Brackets” on page 99.

NOTE: The vertical strip shown in the final image may appear on the right of the panel for some models.

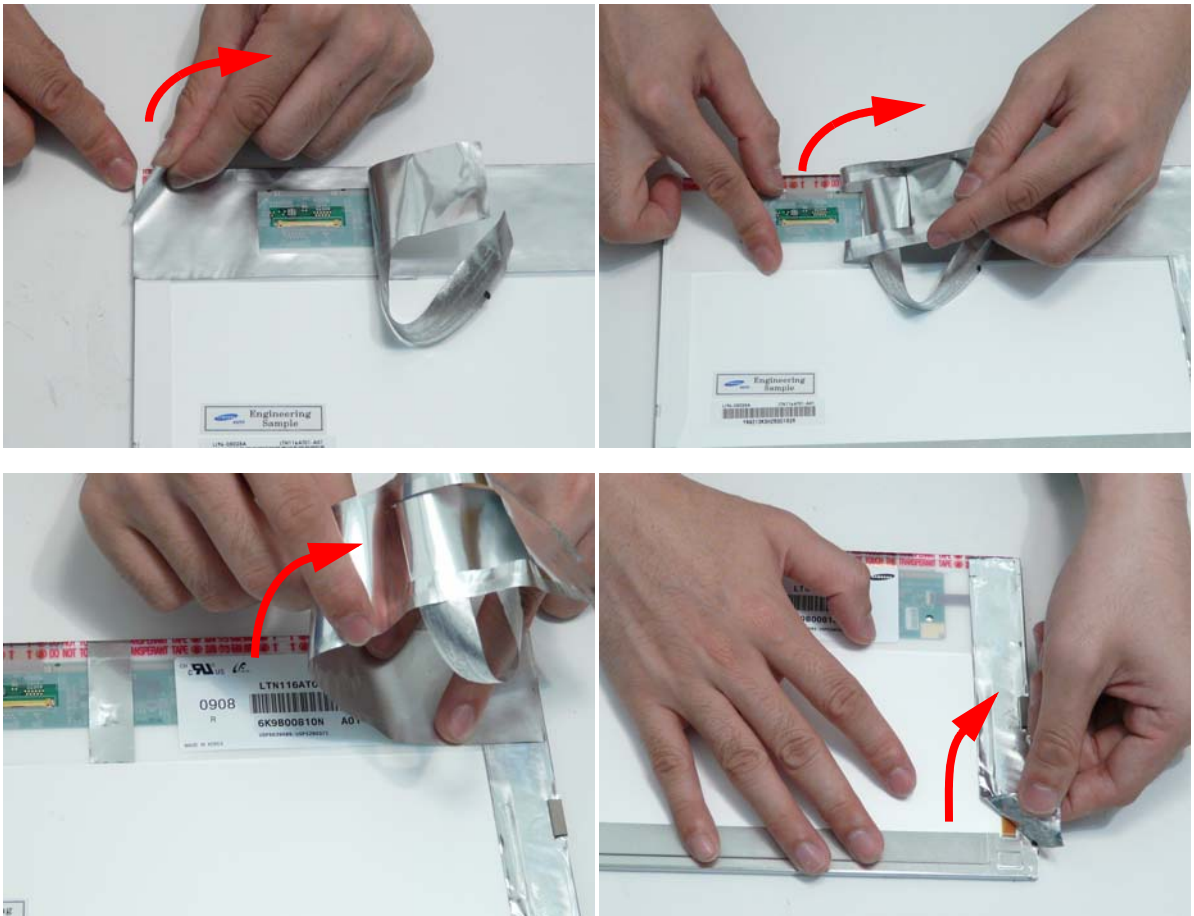

Removing the Antennas

1. See "Removing the LCD Panel" on page 90.
2. Carefully pry up the right Antenna pad, as shown, and remove the pad from the LCD Module.
IMPORTANT: A strong adhesive is used to secure the Antenna pad in place. Take care not to bend the pad during removal.

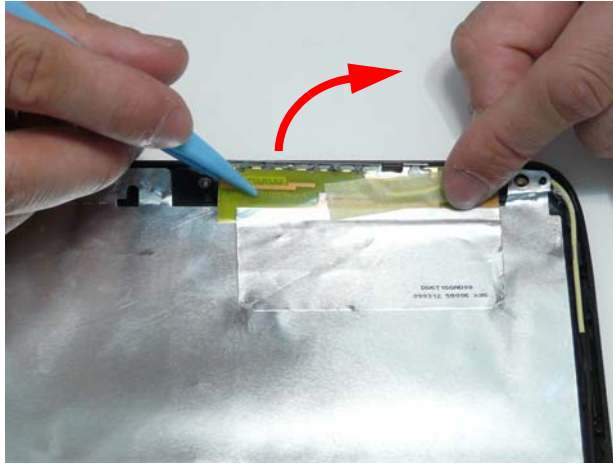

3. Remove the cable from the cable channel. Ensure that the cable is free from all cable clips.

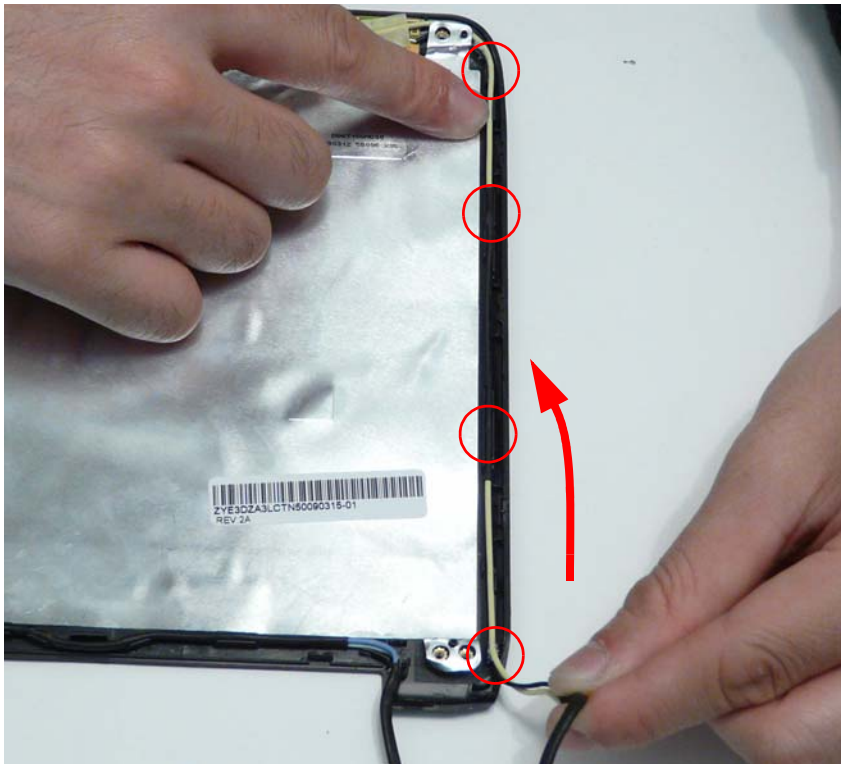

4. Carefully pry up the left Antenna pad, as shown, and remove the pad from the LCD Module.

IMPORTANT: A strong adhesive is used to secure the Antenna pad in place. Take care not to bend the pad during removal.



5. Remove the cable from the cable channel. Ensure that the cable is free from all cable clips.

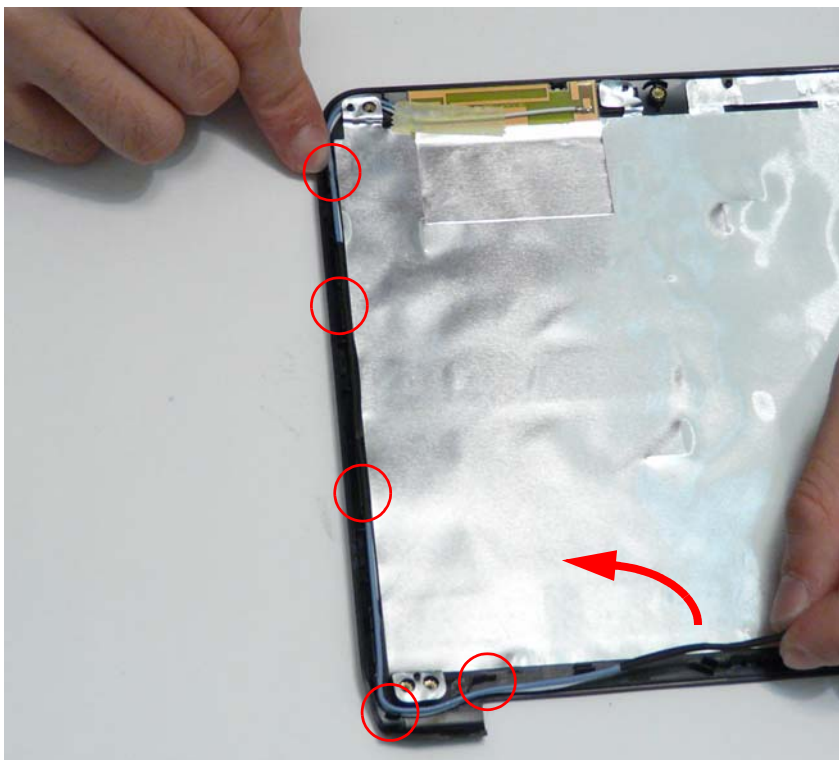

LCD Module Reassembly Procedure

Replacing the Antennas

1. Remove the protective covering on the left and right Antenna pads. Place the Antenna pads in the LCD Module and press down to secure the adhesive in place.

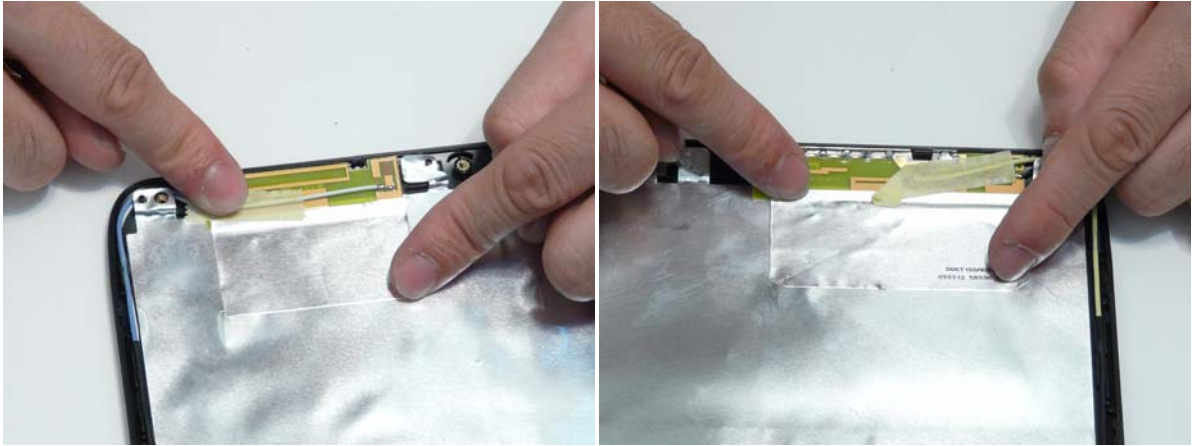

2. Run the left side cable down the side and along the lower edge of the LCD Module using all the available cable clips.



3. Run the right side cable down the side of the LCD Module using all the available cable clips.



NOTE: The LCD Module appears as shown when the Antennas are replaced correctly. Ensure that the Antennas run through the hinge well as shown to avoid trapping when the LCD Panel is replaced.



Replacing the LCD Cable and Brackets

IMPORTANT: If the LCD Panel is replaced, remove the protective strips from the defective panel and reuse them on the replacement panel as shown.

NOTE: The vertical strip shown in the first image may appear on the right of the panel for some models.

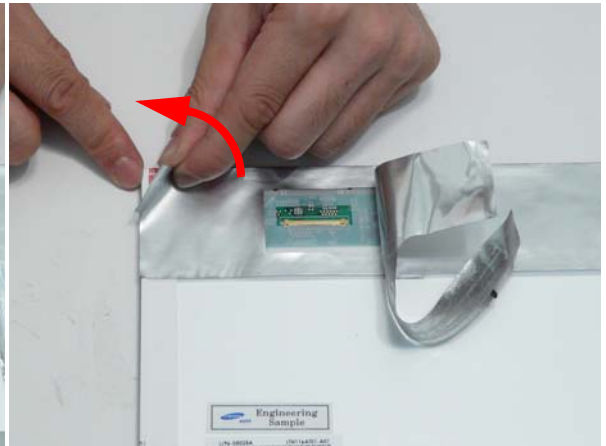
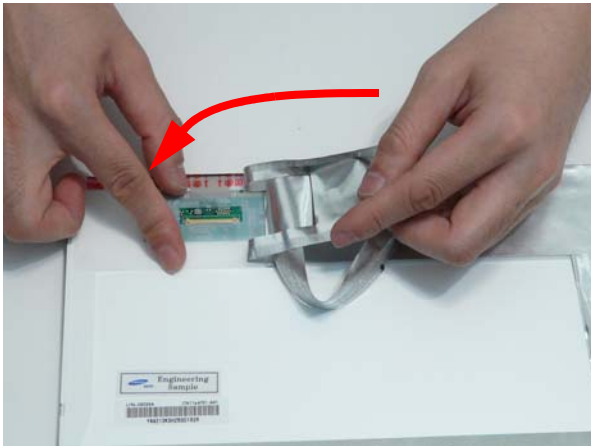
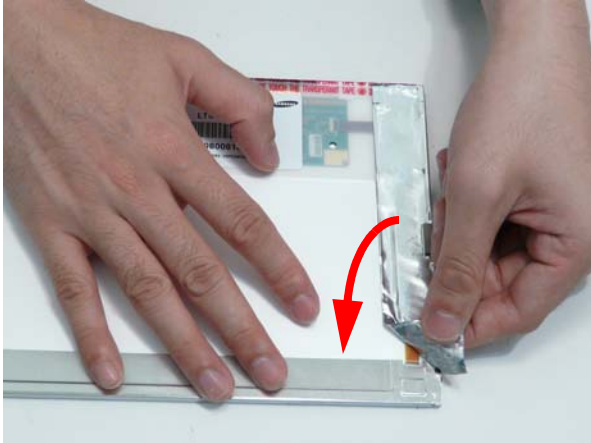

1. Insert the LCD Cable into the panel connector as shown.

2. Secure the connector by replacing the adhesive strip as shown. Press down to secure the adhesive.

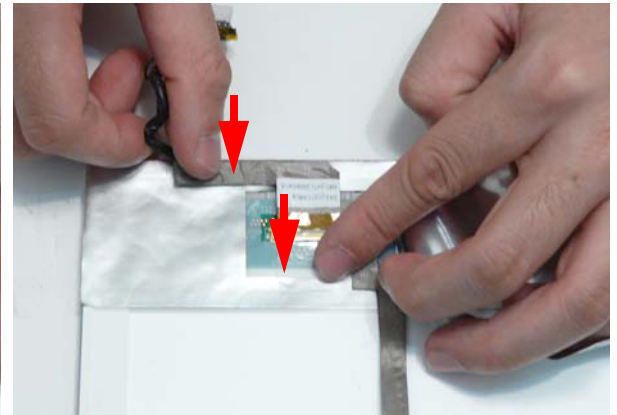
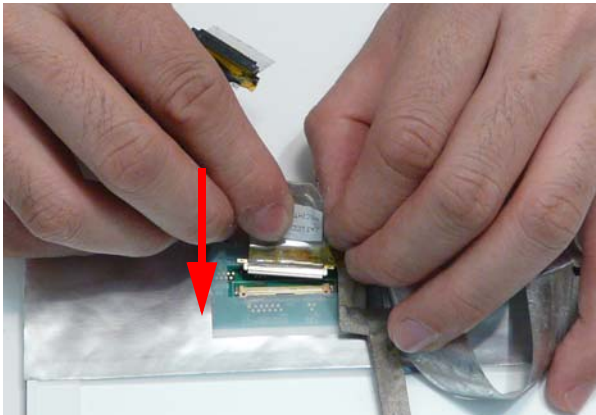

3. Run the LCD cable along the bottom of the panel as shown. Press down to secure the adhesive.

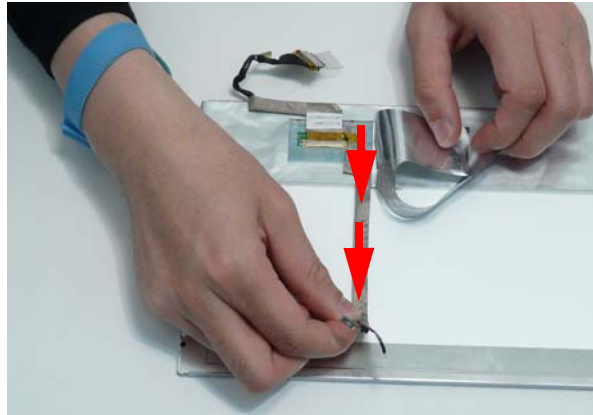

IMPORTANT: Ensure that the LCD Cable runs as shown to avoid trapping when the Bezel is replaced.

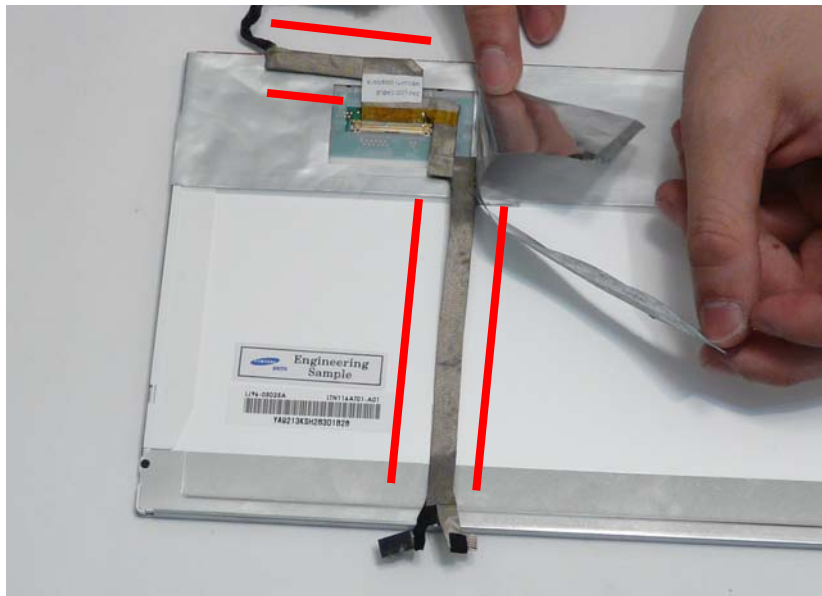

4. Replace the cable protection strip and press down to secure it in place.

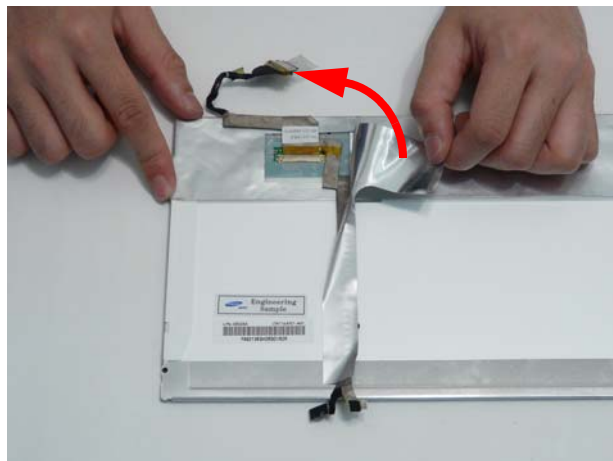

5. replace the four screws (two each side) securing the LCD Brackets to the LCD Panel.

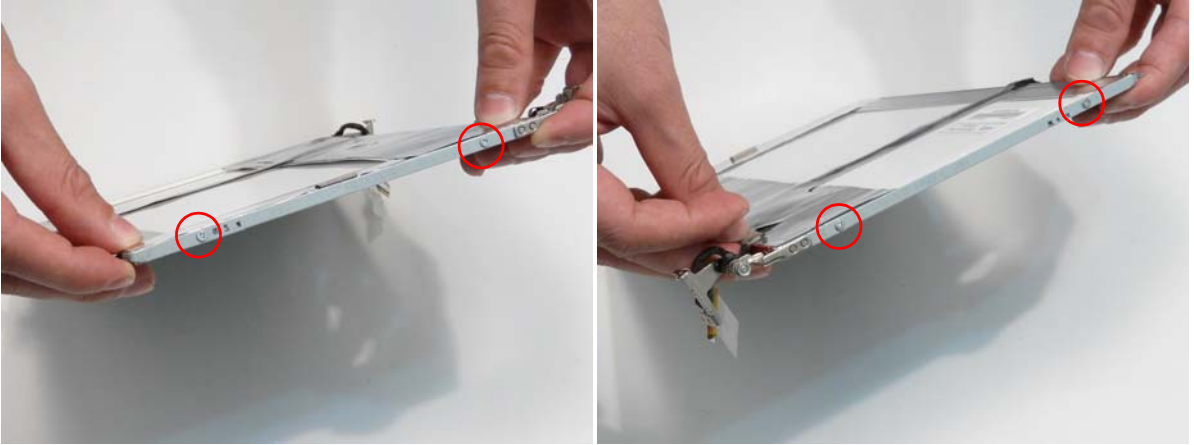

Replacing the LCD Panel

1. Replace the LCD Panel top edge first as shown. Lower the Panel in to the LCD Module, ensuring the LCD cables are not trapped between the panel and the casing.



2. Ensure the cables and Antennas pass through the hinge wells as shown.



3. Press down to secure the adhesive holding the Microphone in place.

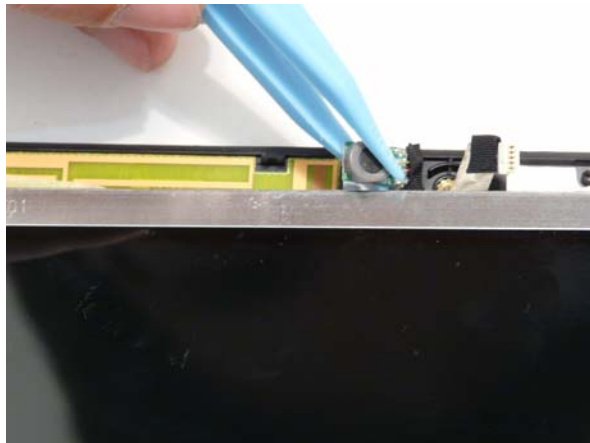

-
4. Replace the two securing screws.



Replacing the Camera Board

1. Align the locating slots on the Camera Module with the locating pins on the LCD Module.
2. Place the Camera Module in the LCD Module and press down to secure it in place.

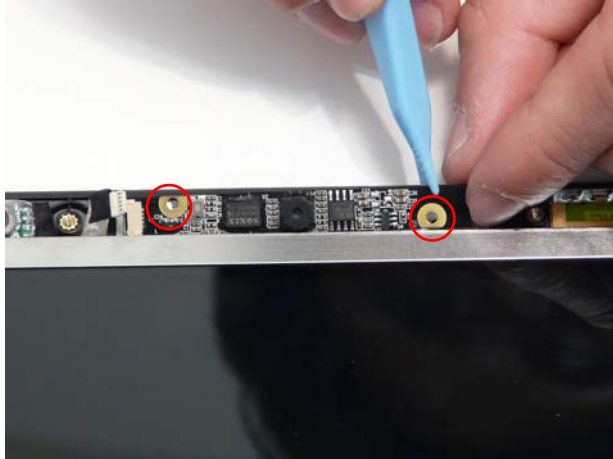

3. Connect the Camera cable as shown.

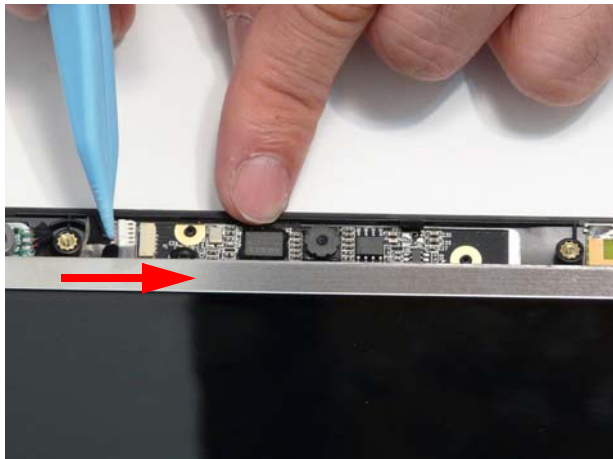

Replacing the LCD Bezel

1. Replace the bezel bottom edge first as shown. Ensure that the cables are not trapped between the bezel and LCD Module and pass through the hinge wells.



2. Press down around the edges of the bezel until there are no gaps between the covers.

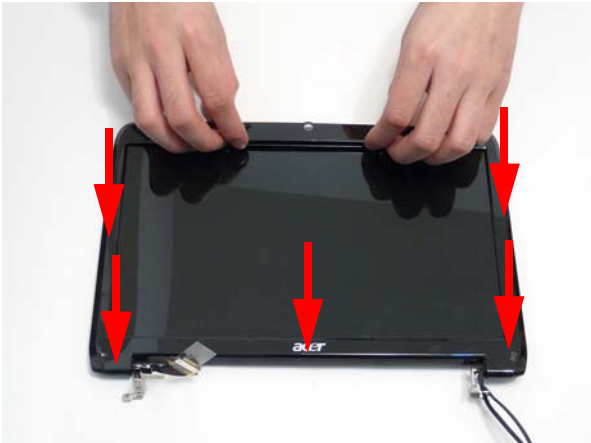

3. Replace the six screws securing the bezel to the LCD Module.



Main Module Reassembly Procedure

Replacing the Thermal Module

IMPORTANT: Ensure all heat pads are in place before replacing the Thermal Module.

The following thermal pads are approved for use:

- Eapus XR-PE

1. Place the pads as shown.

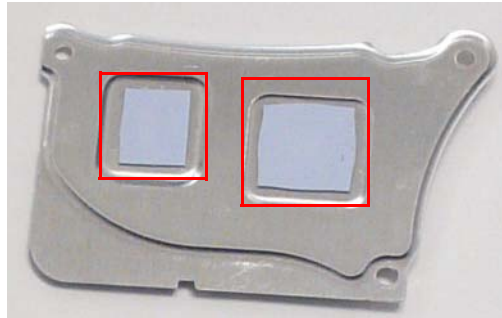

2. Place the Thermal Module onto the Mainboard.

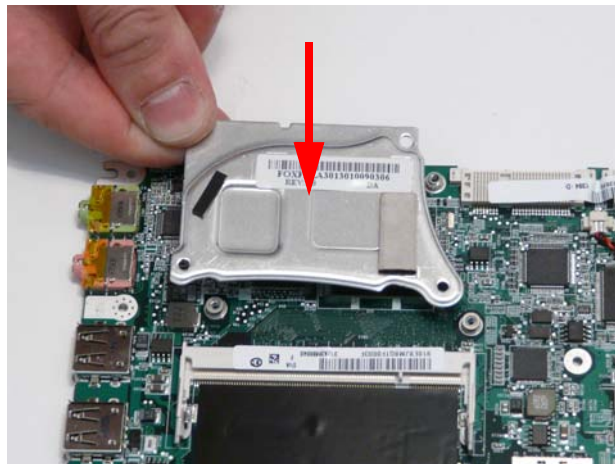

3. Replace the three screws securing the Thermal Module to the Mainboard.

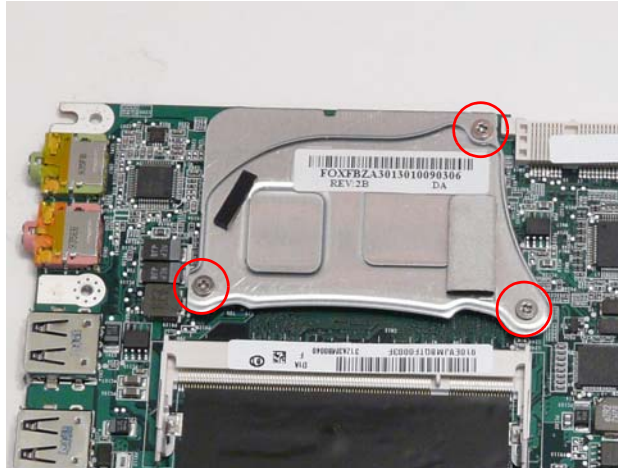

Step	Size	Quantity	Screw Type
Thermal Module	M2*2	3	

Replacing the Mainboard

1. Connect the CRT cable as shown.

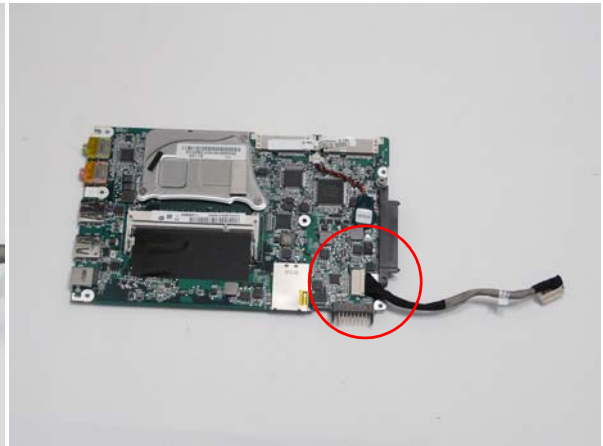
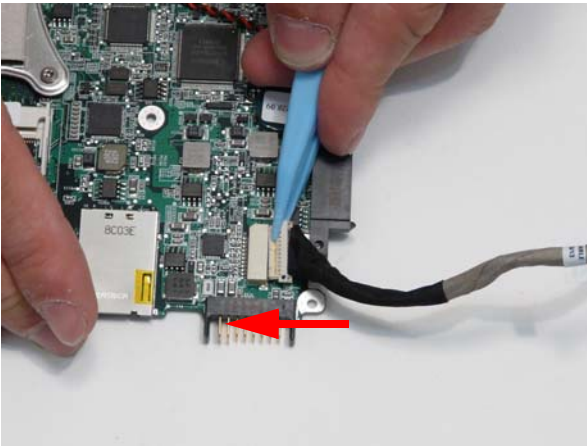

2. Turn the Mainboard over and slide the mainboard into the Lower Cover right side-first.

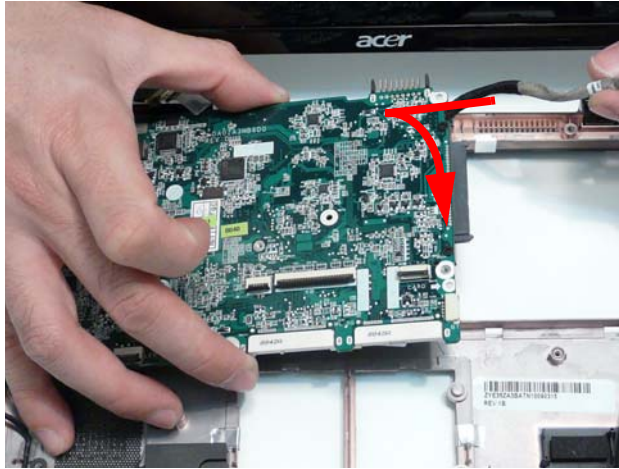

3. Replace the single screw in the lower-left corner to secure the Mainboard to the Lower Cover.

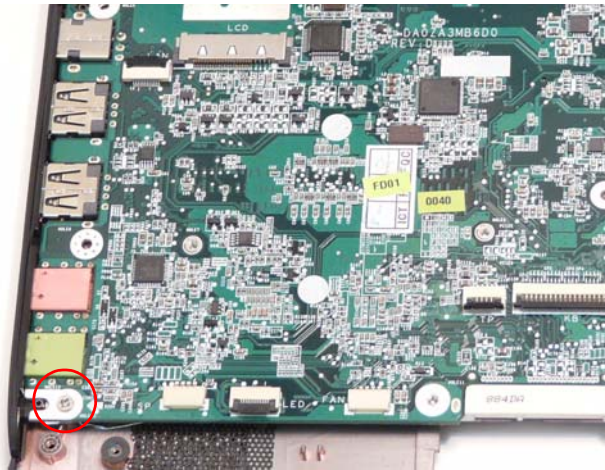

Step	Size	Quantity	Screw Type
Mainboard	M2*5	1	

Replacing the Speaker Module

1. Place the right side speaker into the Lower Cover as shown.

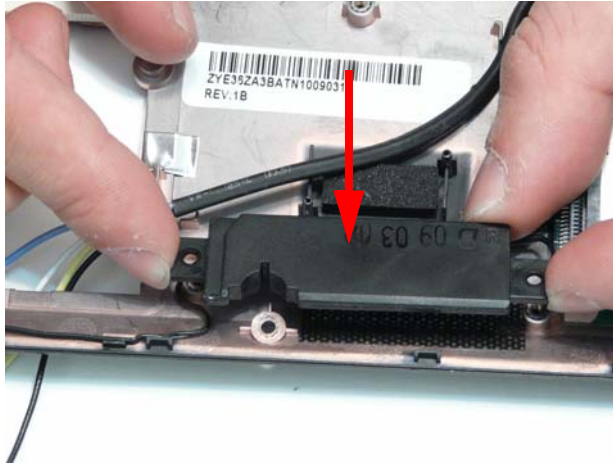

2. Insert the cable into the cable channel at the front of the Lower Cover. Ensure the cable is secured by all cable clips.

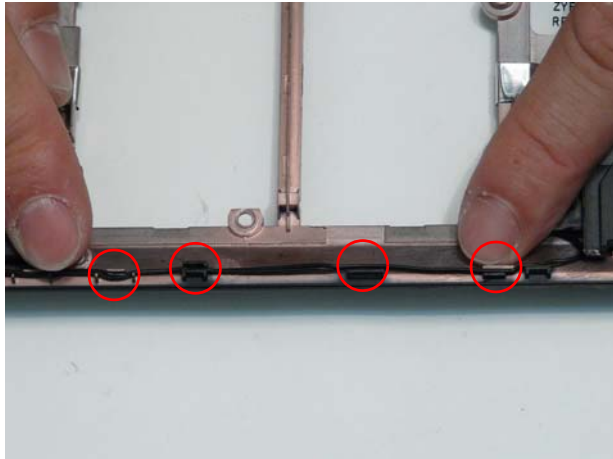

3. Place the left side speaker into the Lower Cover as shown.

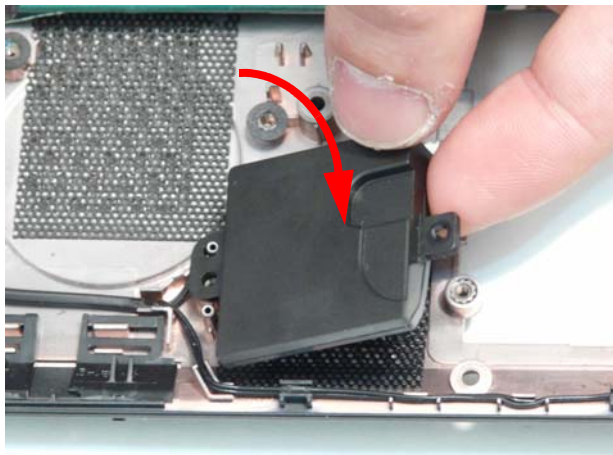

4. Insert the Speaker cable into the cable channel. Ensure that the cable passes through all cable clips.

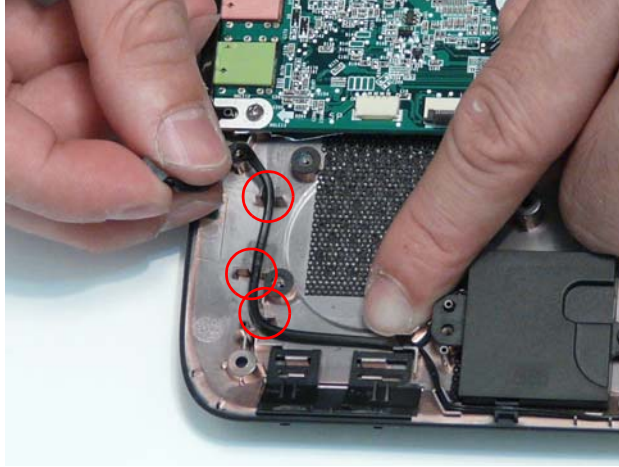

5. Replace the three screws to secure the Speakers to the Lower Cover.

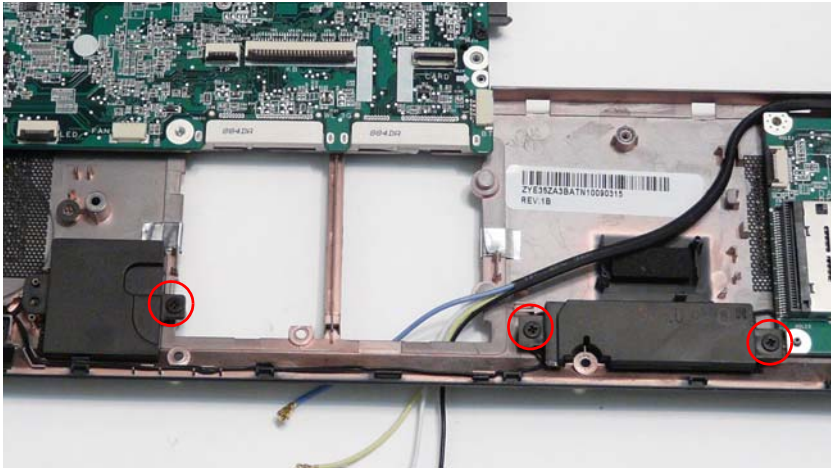

Step	Size	Quantity	Screw Type
Speaker Module	M2*3	3	

6. Connect the Speaker cable to the Mainboard.

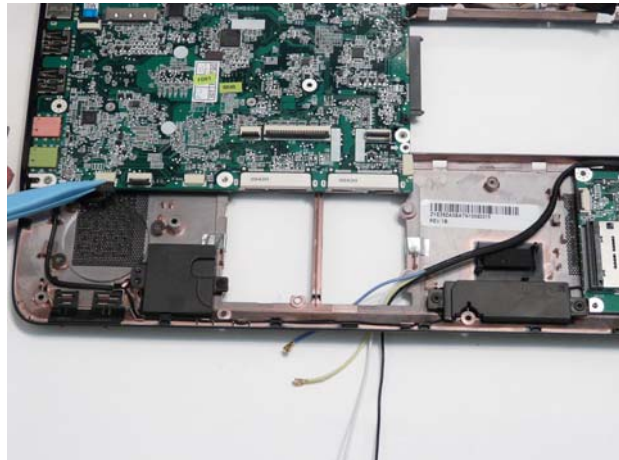

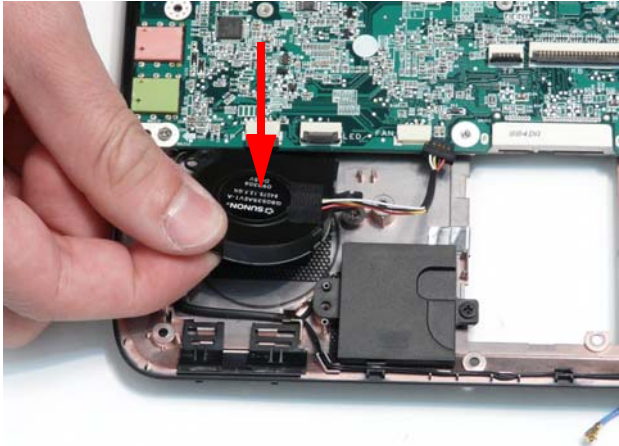

Replacing the CPU Fan

1. Place the CPU Fan into the Lower Cover.

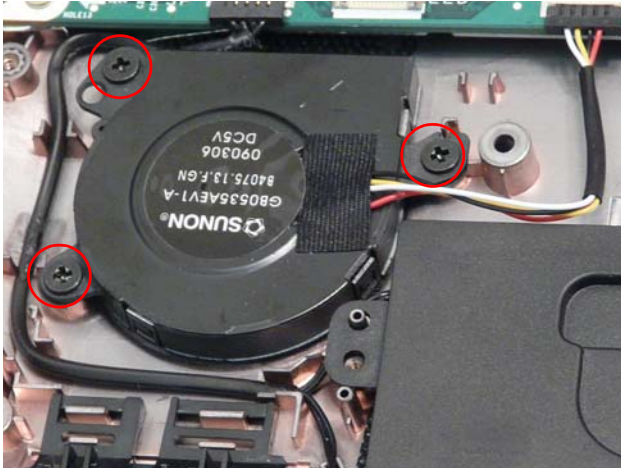

2. Replace the three screws to secure the CPU Fan to the Lower Cover.



Step	Size	Quantity	Screw Type
CPU Fan	M2*3	3	

3. Connect the fan power cable to the Mainboard.



Replacing the LED Board

1. Place the LED Board into the Lower Cover.



2. Replace the single screw to secure the LED Board to the Lower Cover.



Step	Size	Quantity	Screw Type
LED Board	M2*5	1	

3. Connect the LED Board FFC to the LED Board and close the locking latch.

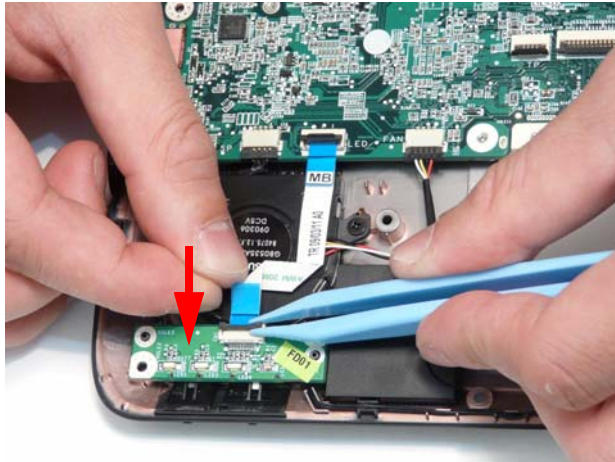

4. Connect the LED Board FFC to the Mainboard and close the locking latch.

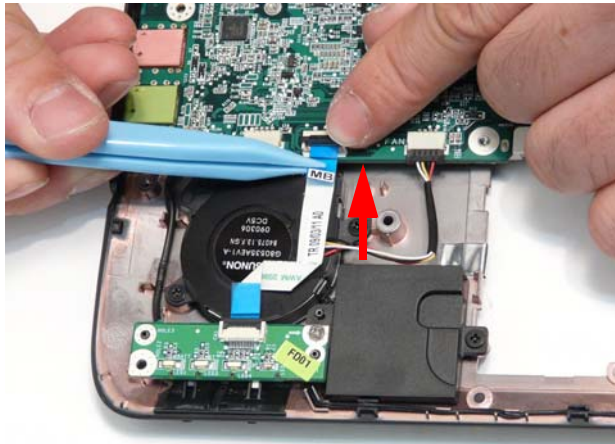

Replacing the Bluetooth Module

1. Insert the Bluetooth Module, right side first, into Lower Cover so that it is held by the tab.

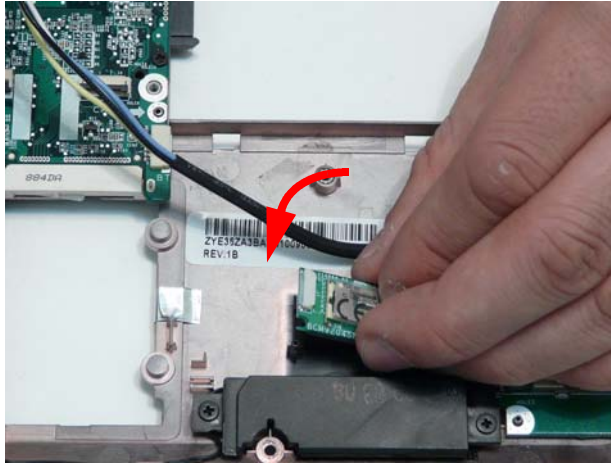

2. Connect the cable to the Bluetooth Module.

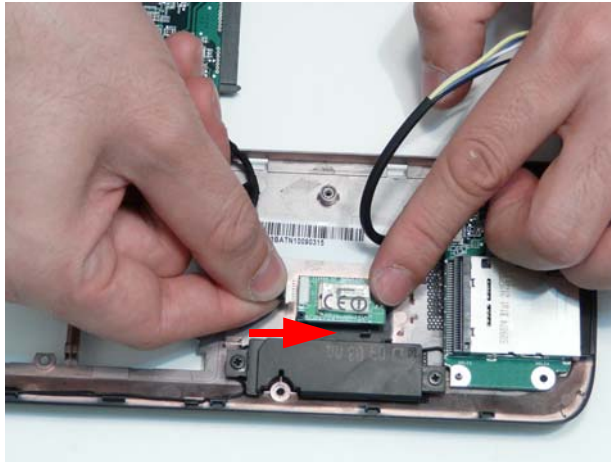

3. Press on the adhesive strip to attach the cable to the Lower Cover.

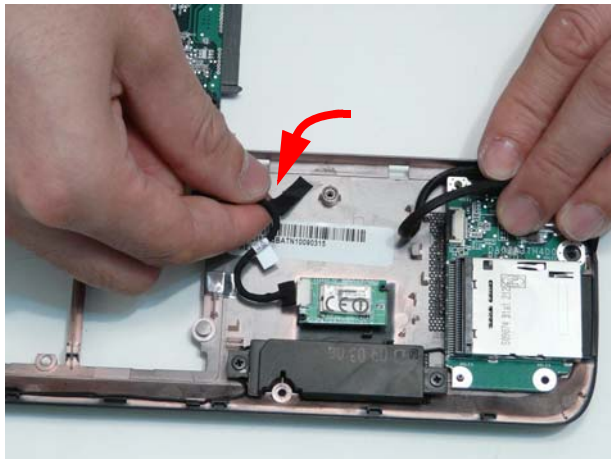

4. Connect the Bluetooth cable to the Mainboard.

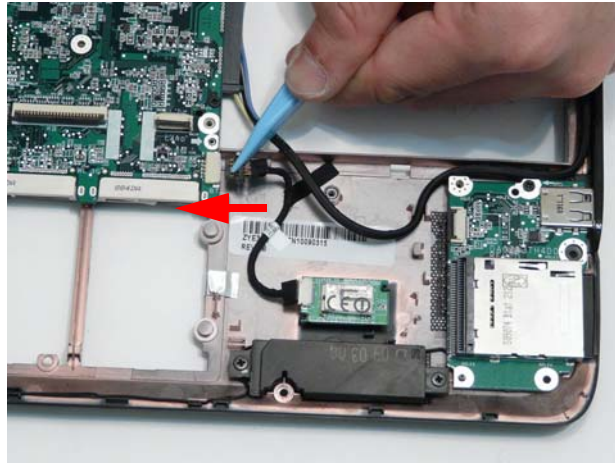

Replacing the LCD Module

IMPORTANT: Ensure that the LCD cables are not pinched by the hinges while replacing the LCD Module.

1. Using both hands, place the LCD Module into the Lower Cover.

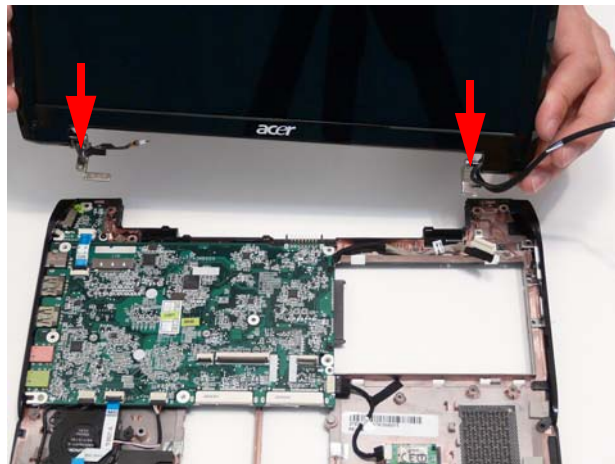



2. Replace the three screws (two on the left hinge and one on the right) to secure the LCD Module to the Lower Cover.

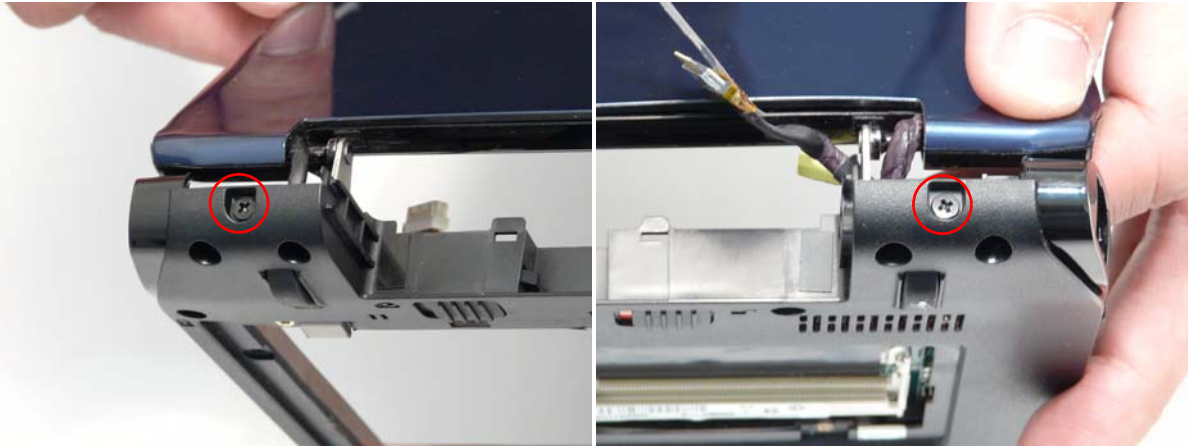

Step	Size	Quantity	Screw Type
LCD Module	M2*5	3	

3. Replace the two screws on the rear of the Lower Cover to secure the LCD Module to the computer.



Step	Size	Quantity	Screw Type
LCD Module	M2*3	2	

4. Insert the Antenna cables into the cable channel on the Lower Cover as shown, all the way from the hinge well.

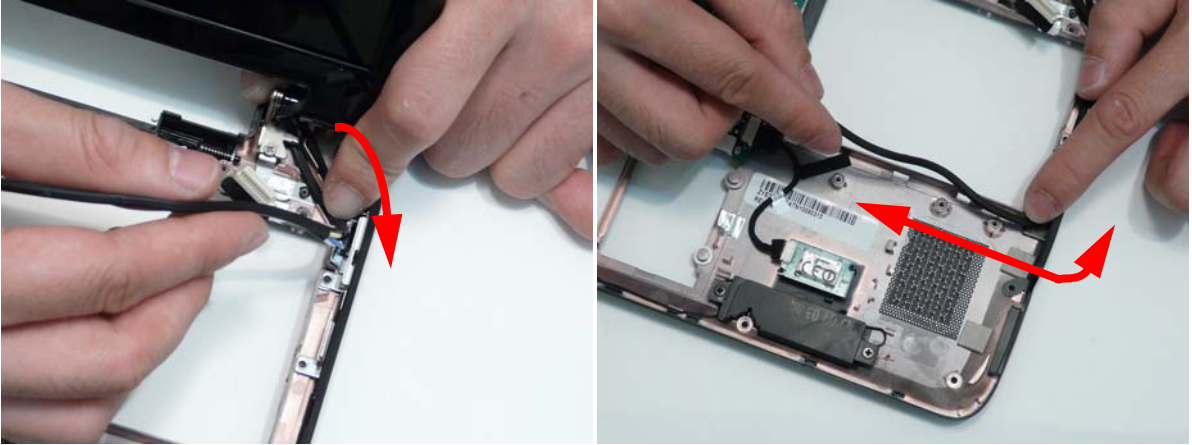

5. Connect the LVDS cable to the Mainboard and press the adhesive strip in place.

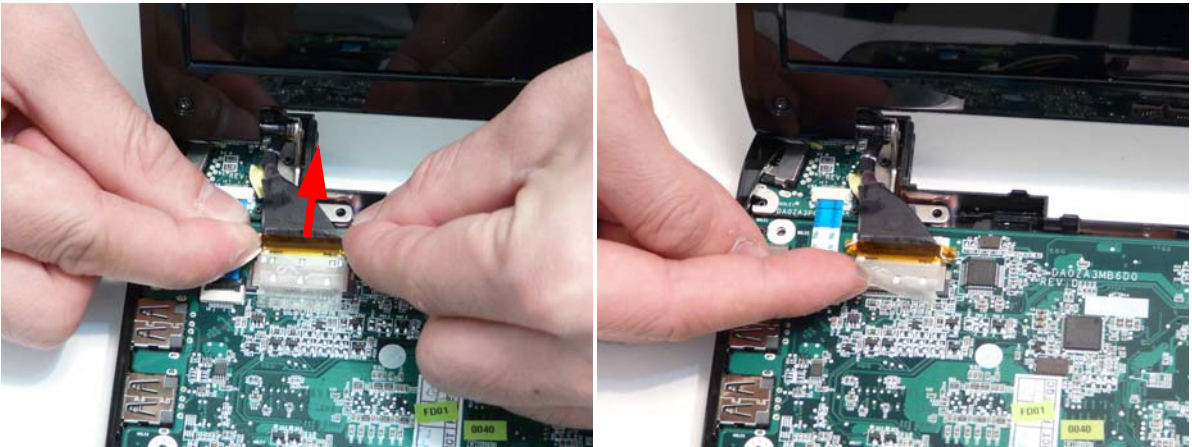

Replacing the LAN Board

NOTE: The LVDS cable needs to be disconnected to allow access for replacing the LAN board.

1. Lift the adhesive strip securing the LVDS cable in place and disconnect the cable from the Mainboard.

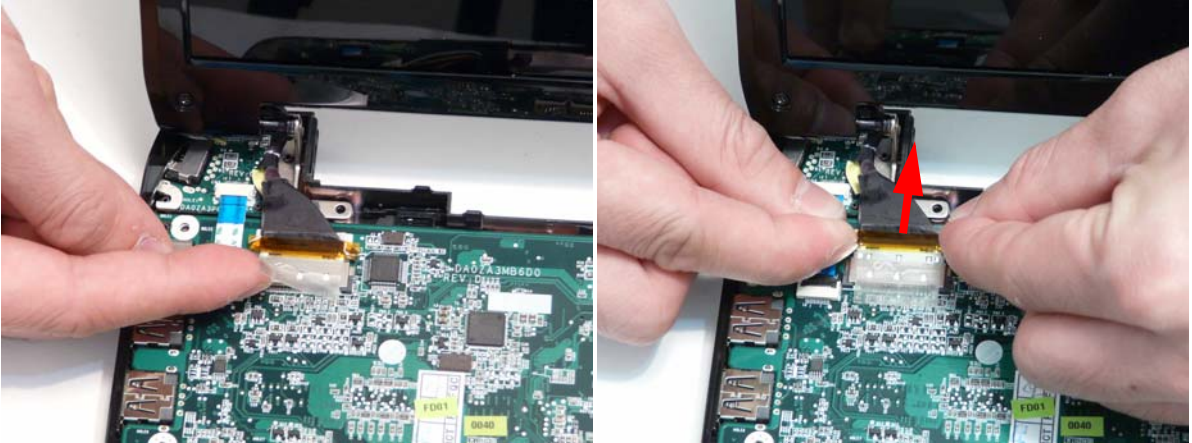

2. Push the RJ-45 connector through the Lower Cover as shown and place the LAN Board into the Lower Cover.

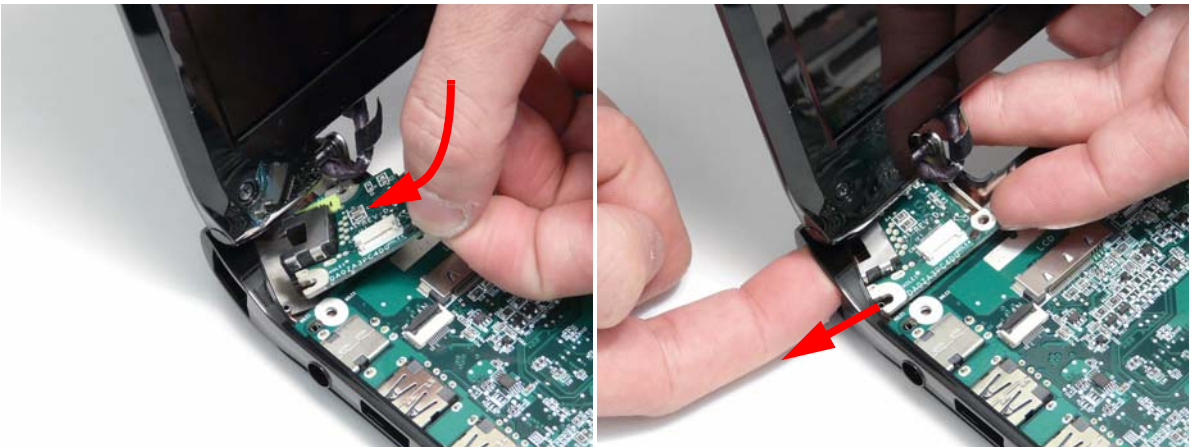

3. Replace the single screw to secure the LAN Board to the Lower Cover.



Step	Size	Quantity	Screw Type
LAN Board	M2*5	1	

4. Connect the FFC cable to the LAN Board by pushing on the cable tab as shown.

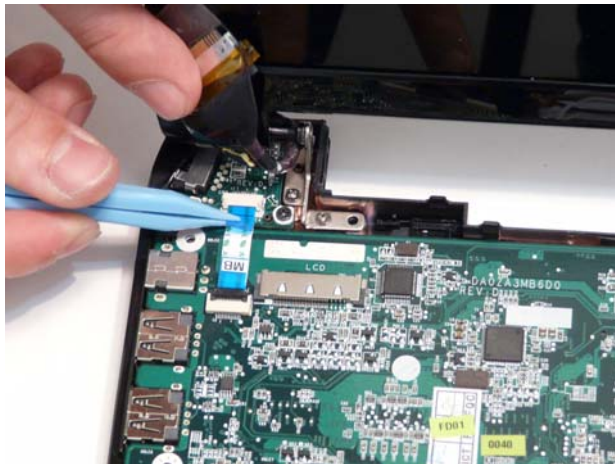

5. Connect the LAN Board cable to the Mainboard and close the locking latch.

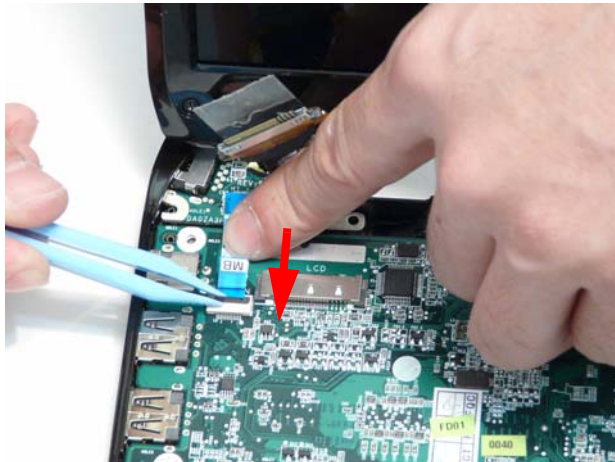

6. Replace the LVDS cable.

Replacing the CRT Board

1. Connect the cable from the CRT Board and insert the board into the Lower Cover.

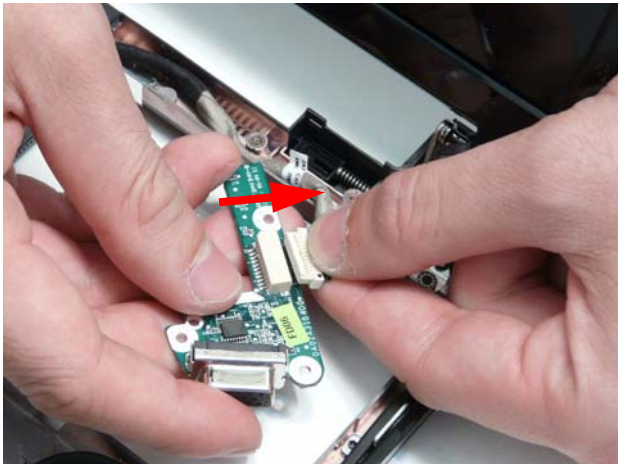

2. Turn the CRT Board over and place it into the cover right side first.

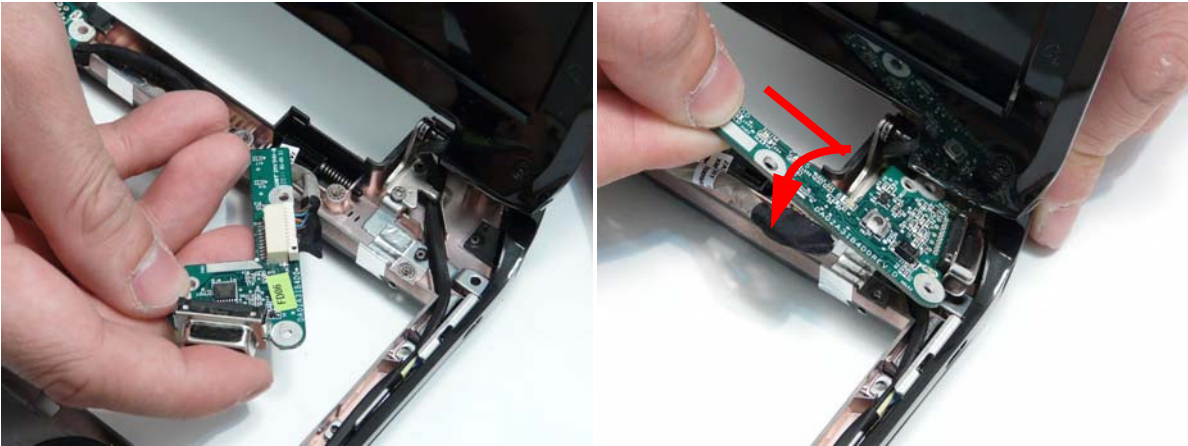

3. Replace the single screw to secure the CRT Board to the Lower Cover.



Step	Size	Quantity	Screw Type
CRT Board	M2*5	1	

Replacing the Card Reader Board

1. Place the board into the Lower Cover, right side first so the I/O ports align with the openings in the lower cover.

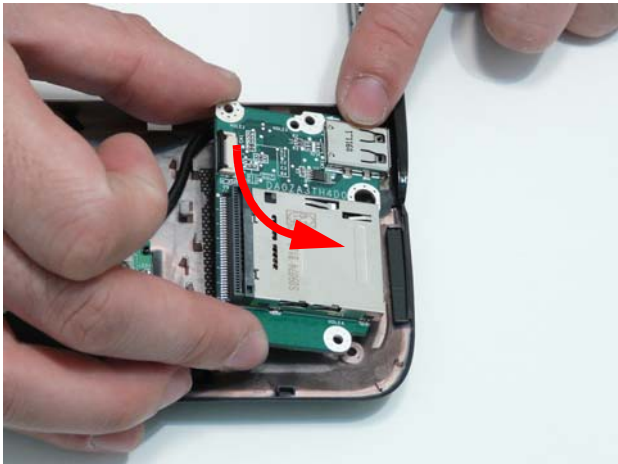

2. Replace the single screw to secure the Card Reader Board to the Lower Cover.



Step	Size	Quantity	Screw Type
Card Reader Board	M2*5	1	

3. Connect the FFC to the Mainboard and close the locking latch.

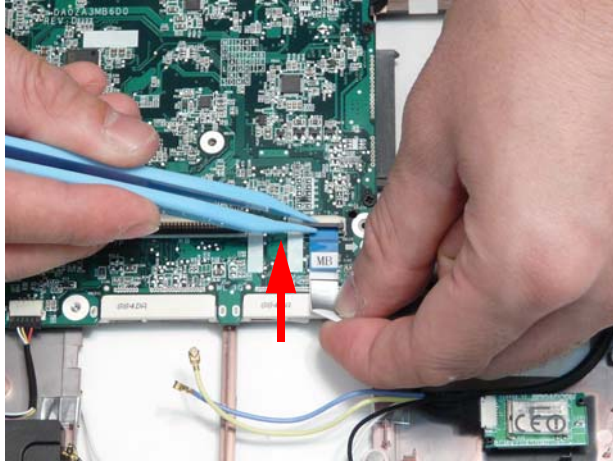

4. Connect the FFC to the Card Reader Board and close the locking latch.



Replacing the TouchPad Bracket and Button Board

IMPORTANT: The TouchPad Board cannot be removed from the Upper Cover. To replace the TouchPad Board, replace the entire Upper Cover.

1. Push the FFC through the cover as shown.

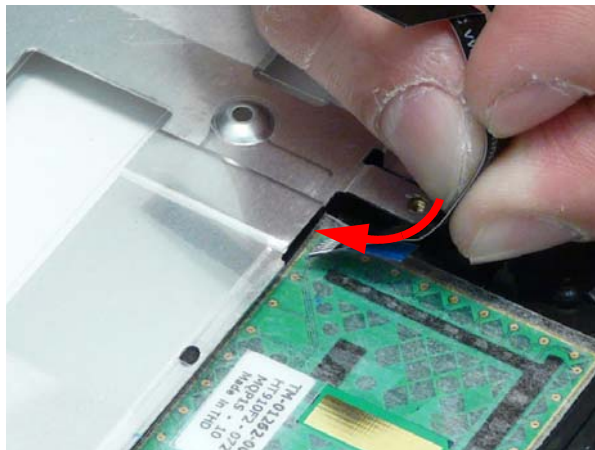

2. Turn the Upper Cover over and pull the FFC through the cover as shown.

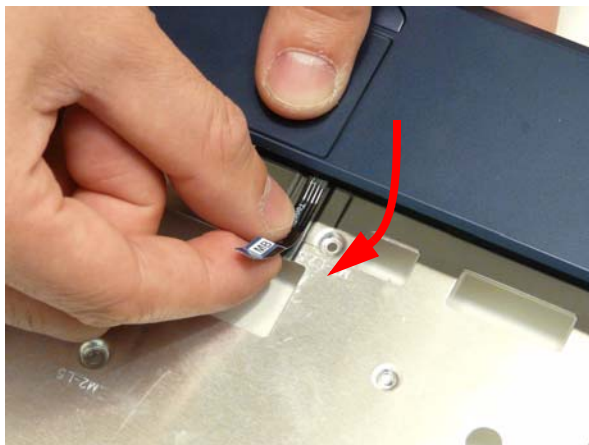

3. Replace the adhesive strip to secure the TouchPad FFC in place.

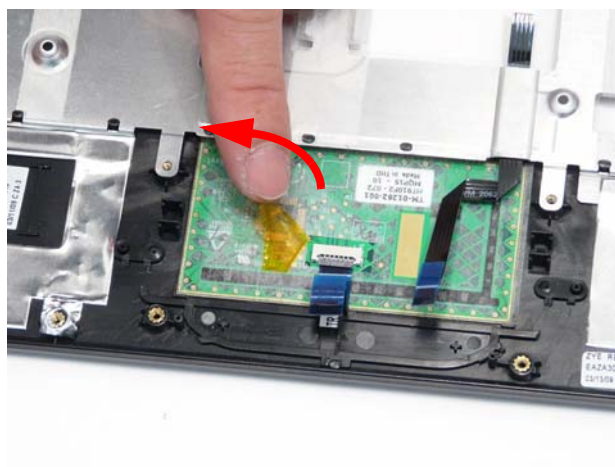

4. Connect the FFC to the TouchPad connector and close the FFC locking latch.

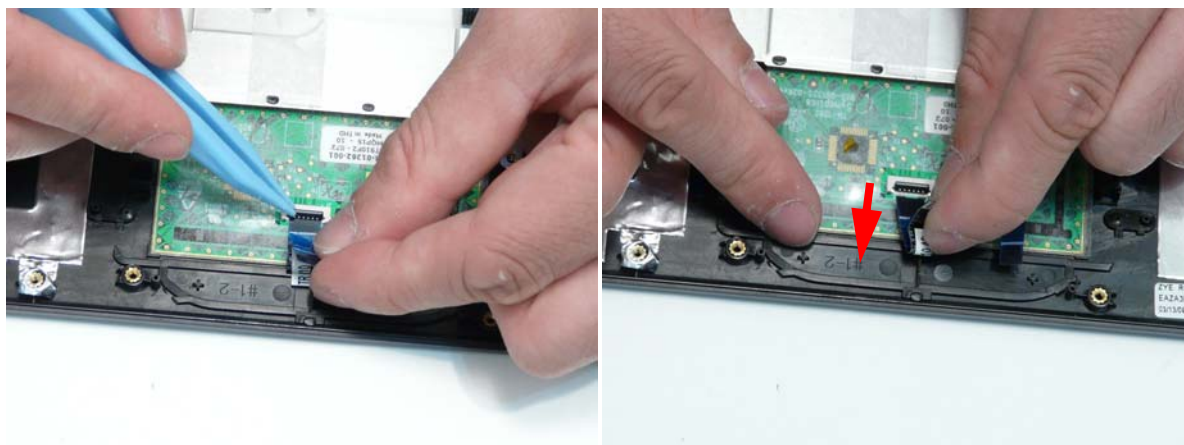

5. Place the Button Board into the bracket and turn the TouchPad Bracket over, taking care to align the screw holes.

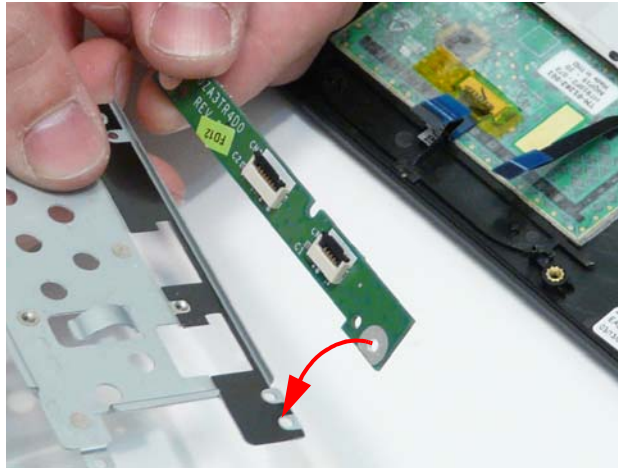

6. Insert the TouchPad Bracket into the Upper Cover.

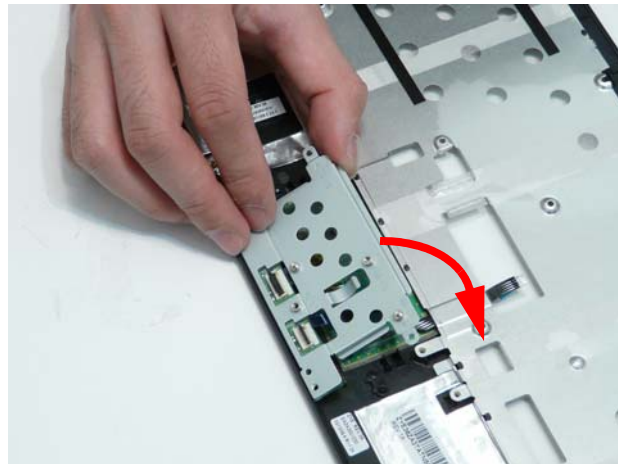

7. Replace the three screws to secure the TouchPad Bracket to the Upper Cover.

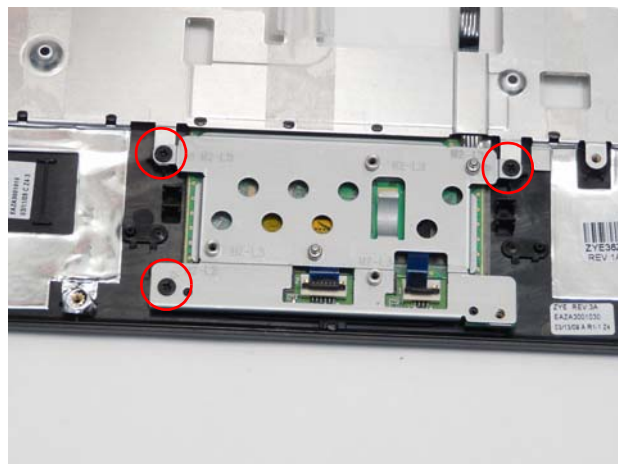

Step	Size	Quantity	Screw Type
TouchPad Bracket	M2*3	3	

8. Connect the two FFCs to the Button Board and close the locking latches as shown.

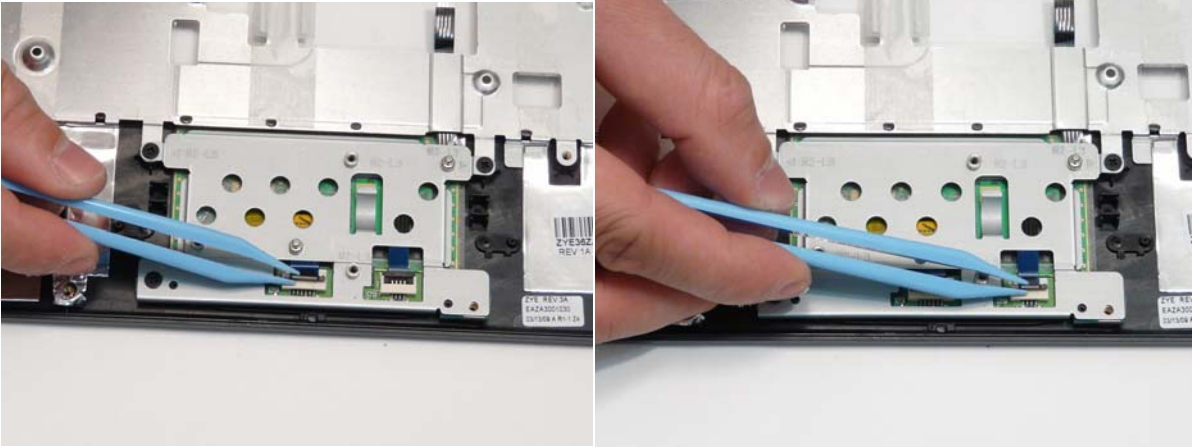

Replacing the Upper Cover

1. Place the Upper Cover into the Lower Cover back edge first.





2. lightly press the edges of the cover in place to align it to the lower cover.,

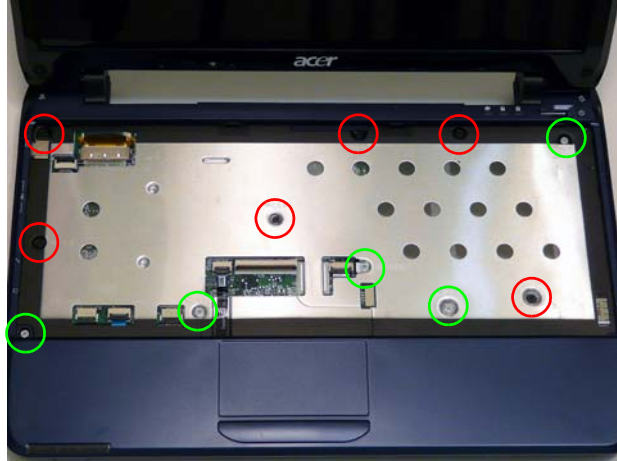

3. Replace the eleven screws to secure the Upper Cover.



Step	Size	Quantity	Screw Type
Upper Cover (red callout)	M2*5	6	
Upper Cover (green callout)	M2*2.5	5	

4. Connect the following cable to the Mainboard.

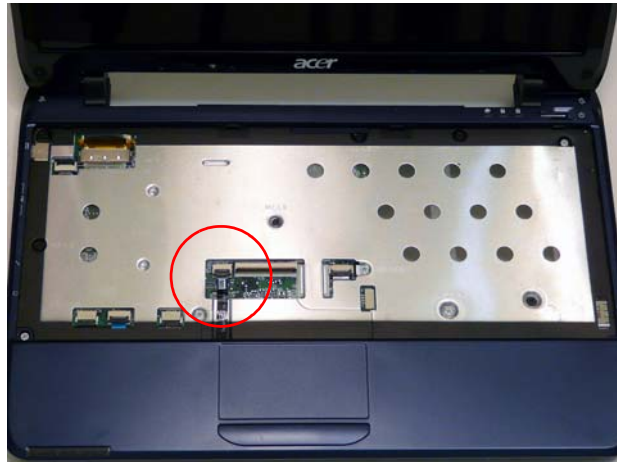



Connect the FFC as shown.

Close the locking latch as shown.



5. Turn the computer over and replace the ten screws to secure the Upper Cover to the Lower Cover.



Step	Size	Quantity	Screw Type
Upper Cover (red callouts)	M2*5	9	
Upper Cover (green callouts)	M2*3	1	

Removing the Hinge Covers

1. Connect the Hinge Covers to the Upper Cover as shown.

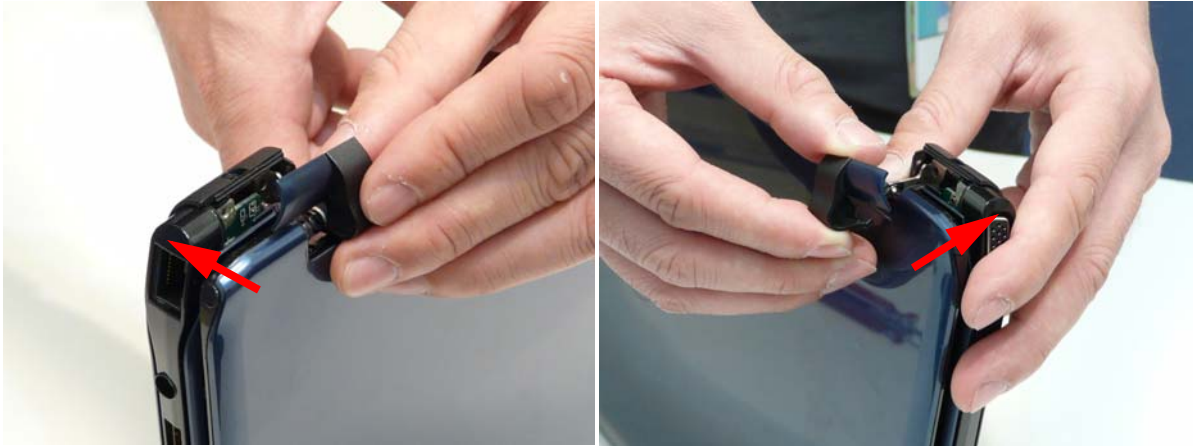

2. Turn the computer over. Replace the four screws to secure the Hinge Covers to the Lower Cover.

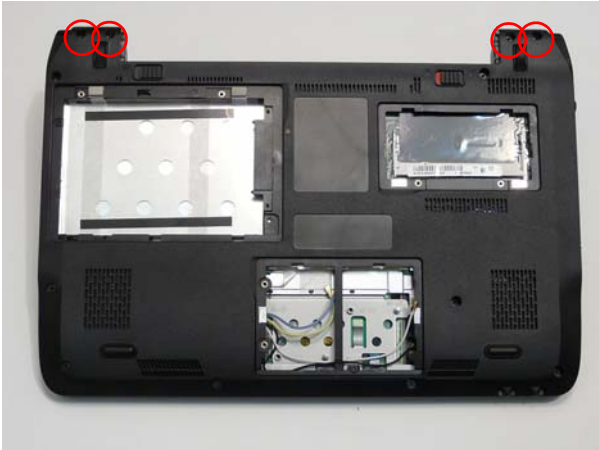

Step	Size	Quantity	Screw Type
Hinge Covers	M2*5	4	

Removing the Keyboard

1. See "Removing the Battery Pack" on page 44.

2. Turn the computer rightside up and open the lid to the full extent.
3. Holding the keyboard on edge, insert the Keyboard FFC and secure the latch as shown.



4. Place the Keyboard into the Upper Cover bottom edge first, taking care to align the mounting tabs.



5. Press the keyboard into place in the four indicated points. An audible click indicates the keyboard is in place.



Reassembling External Modules

Removing the 3G Module

IMPORTANT: 3G functionality is not supported by all models.

1. Attach the 3G Module to the socket.



NOTE: When replacing the 3G module, ensure the cables are tucked into the chassis to prevent damage.

2. Move the antenna away and replace the single screw for the 3G Module.



Step	Size	Quantity	Screw Type
3G Module	M2*3	1	

3. Connect the 3G Antenna cables to the 3G Module.

IMPORTANT: The Blue cable attaches to the MAIN terminal (left) and the Yellow cable attaches to the AUX terminal (right).



Replacing the WLAN Board

1. Insert the WLAN Board into the Mainboard.



2. Replace the single screw to secure the WLAN Board in place.



Step	Size	Quantity	Screw Type
WLAN Board	M2*3	1	

3. Connect the Antenna cables to the WLAN Board.

NOTE: Cable placement is Black to the MAIN terminal (right) and White to the AUX terminal (left).



Removing the DIMM Module

1. Insert the DIMM module at an angle then push down into place until the latches on the sides click into place.



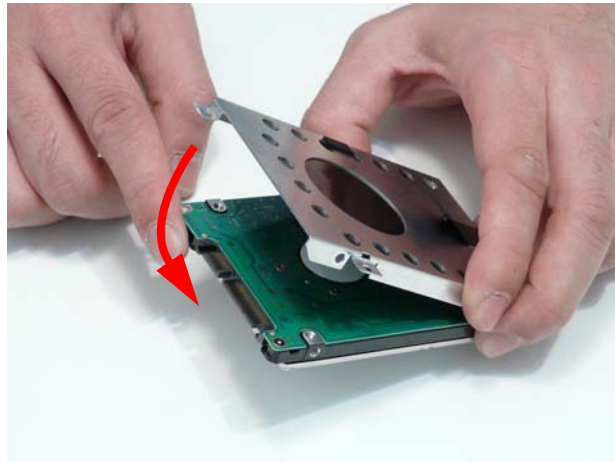

Replacing the Hard Disk Drive Module

2. Attach the HDD to the carrier.

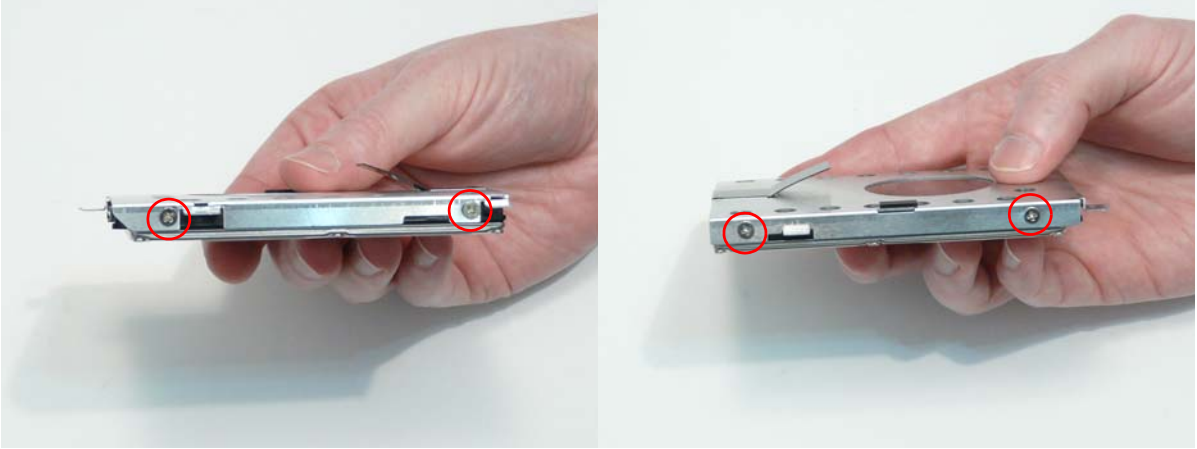

3. Replace the four screws (two each side) to secure the hard disk to the carrier.



Step	Size	Quantity	Screw Type
HDD Carrier	M3*3	4	

4. Place the hard disk drive module into the bay.

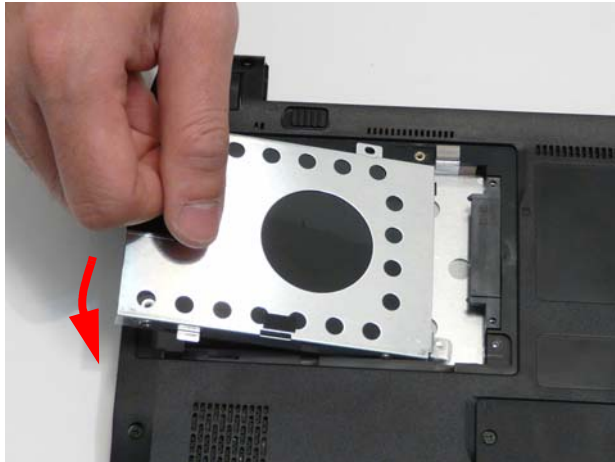

NOTE: To prevent damage to the device, avoid pressing down on it or placing heavy objects on top of it.

5. Slide the HDD in the direction of the arrow to connect the HDD to the interface connector.

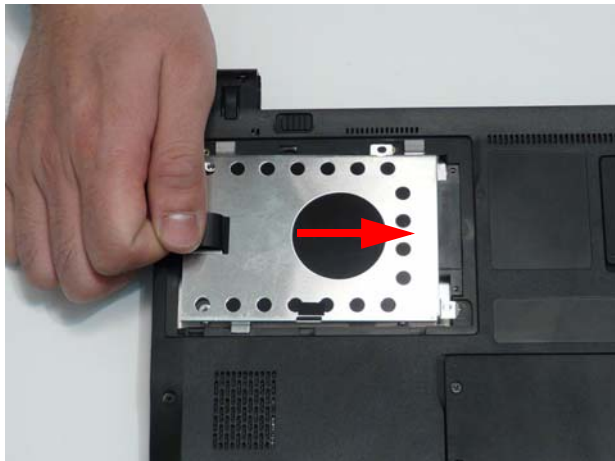

-
6. Replace the single screw to secure the HDD Module in place.



Replacing the Lower Covers

1. Insert the HDD cover into the Lower Cover.



2. Insert the Memory cover into the Lower Cover.



3. Insert the 3G cover into the Lower Cover.



4. Tighten the six captive screws in the HDD, Memory, and 3G Covers.

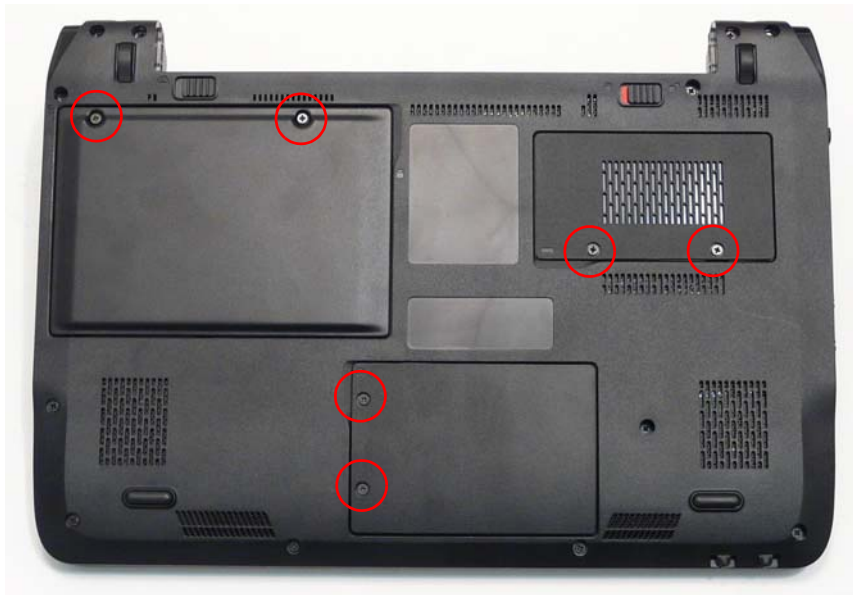

Replacing the Battery Pack

1. Turn the computer over.
2. Slide the battery lock/unlock latch to the unlock position.

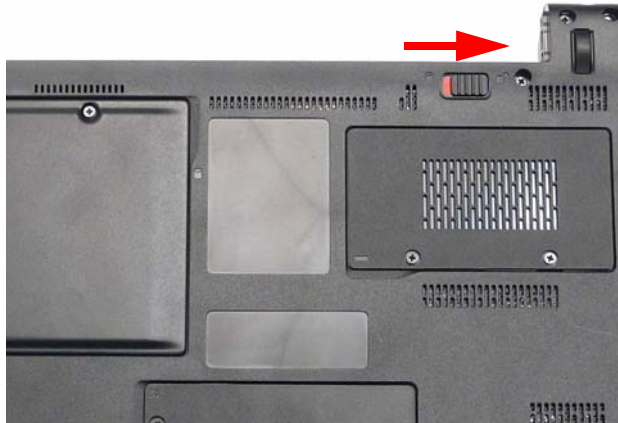

3. Slide and hold the battery release latch to the release position (1), then slide the battery pack into the main unit (2).



Troubleshooting

Common Problems

Use the following procedure as a guide for computer problems.

NOTE: The diagnostic tests are intended to test only Acer products. Non-Acer products, prototype cards, or modified options can give false errors and invalid system responses.

1. Obtain the failing symptoms in as much detail as possible.
2. Verify the symptoms by attempting to re-create the failure by running the diagnostic test or by repeating the same operation.
3. Use the following table with the verified symptom to determine which page to go to.

Symptoms (Verified)	Go To
Power On Issue	Page 138
No Display Issue	Page 139
LCD Failure	Page 141
Internal Keyboard Failure	Page 142
TouchPad Failure	Page 143
Internal Speaker Failure	Page 144
Internal Microphone Failure	Page 146
Rightside USB Failure	Page 148
Modem Failure	Page 149
Other Functions Failure	Page 150
Intermittent Failures	Page 151
Undermined Failures	Page 151

4. If the Issue is still not resolved, see "Online Support Information" on page 189.

Power On Issue

If the system doesn't power on, perform the following actions one at a time to correct the problem. Do not replace non-defective FRUs:

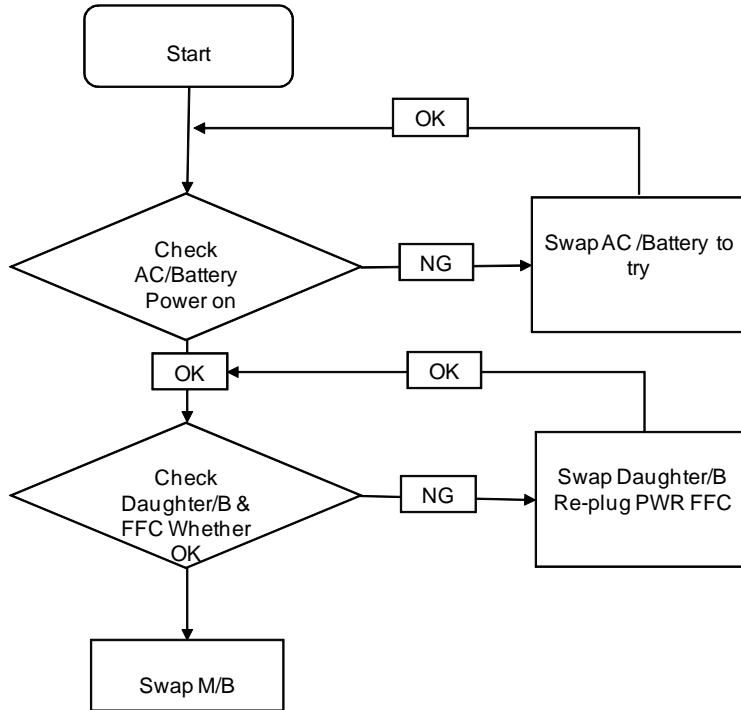

Computer Shuts down Intermittently

If the system powers off at intervals, perform the following actions one at a time to correct the problem.

1. Check the power cable is properly connected to the computer and the electrical outlet.
2. Remove any extension cables between the computer and the outlet.
3. Remove any surge protectors between the computer and the electrical outlet. Plug the computer directly into a known good electrical outlet.
4. Remove all external and non-essential hardware connected to the computer that are not necessary to boot the computer to the failure point.
5. Remove any recently installed software.
6. If the Issue is still not resolved, see "Online Support Information" on page 189.

No Display Issue

If the **Display** doesn't work, perform the following actions one at a time to correct the problem. Do not replace non-defective FRUs:

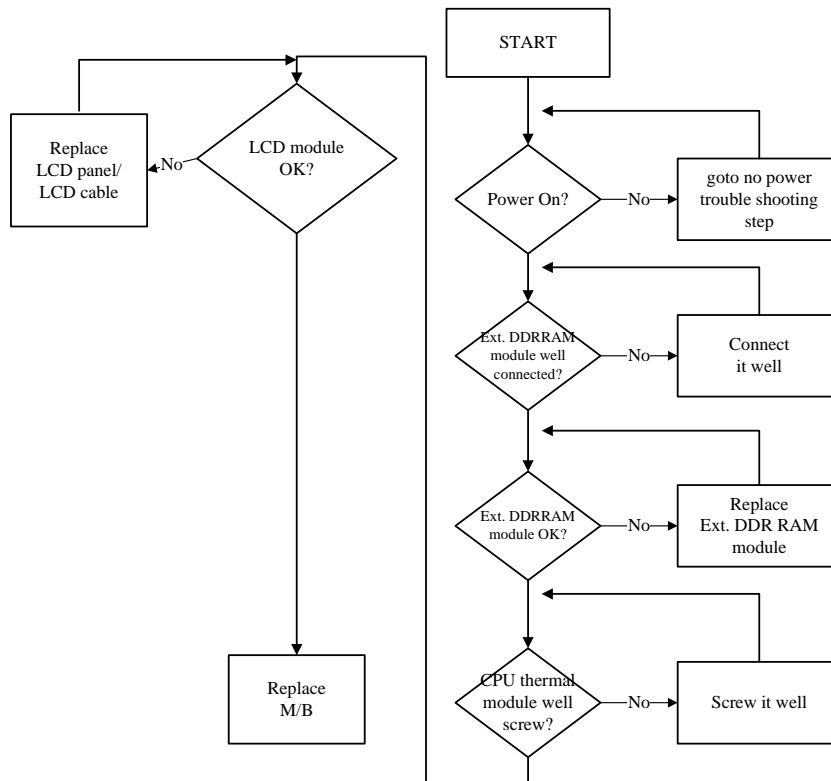

No POST or Video

If the POST or video doesn't display, perform the following actions one at a time to correct the problem.

1. Make sure that the internal display is selected. On this notebook model, switching between the internal display and the external display is done by pressing **Fn+F5**. Reference Product pages for specific model procedures.
2. Make sure the computer has power by checking at least one of the following occurs:
 - Fans start up
 - Status LEDs light up

If there is no power, see “Power On Issue” on page 138.

3. Drain any stored power by removing the power cable and battery and holding down the power button for 10 seconds. Reconnect the power and reboot the computer.
4. Connect an external monitor to the computer and switch between the internal display and the external display is by pressing **Fn+F5** (on this model).

If the POST or video appears on the external display, see “LCD Failure” on page 141.

5. Disconnect power and all external devices including port replicators or docking stations. Remove any memory cards and CD/DVD discs. Restart the computer.

If the computer boots correctly, add the devices one by one until the failure point is discovered.

6. Reseat the memory modules.
7. Remove the drives (see “Disassembly Process” on page 42).
8. If the Issue is still not resolved, see “Online Support Information” on page 189.

Abnormal Video Display

If video displays abnormally, perform the following actions one at a time to correct the problem.

1. Reboot the computer.
2. If permanent vertical/horizontal lines or dark spots display in the same location, the LCD is faulty and should be replaced. See “Disassembly Process” on page 42.
3. If extensive pixel damage is present (different colored spots in the same locations on the screen), the LCD is faulty and should be replaced. See “Disassembly Process” on page 42.
4. Adjust the brightness to its highest level. See the User Manual for instructions on adjusting settings.
NOTE: Ensure that the computer is not running on battery alone as this may reduce display brightness.
If the display is too dim at the highest brightness setting, the LCD is faulty and should be replaced. See “Disassembly Process” on page 42.
5. Check the display resolution is correctly configured:
 - a. Minimize or close all Windows.
 - b. If display size is only abnormal in an application, check the view settings and control/mouse wheel zoom feature in the application.
 - c. If desktop display resolution is not normal, right-click on the desktop and select **Personalize**→ **Display Settings**.
 - d. Click and drag the Resolution slider to the desired resolution.
 - e. Click **Apply** and check the display. Readjust if necessary.
6. Roll back the video driver to the previous version if updated.
7. Remove and reinstall the video driver.
8. Check the Device Manager to determine that:
 - The device is properly installed. There are no red Xs or yellow exclamation marks.
 - There are no device conflicts.
 - No hardware is listed under Other Devices.
9. If the Issue is still not resolved, see “Online Support Information” on page 189.
10. Run the Windows Memory Diagnostic from the operating system DVD and follow the onscreen prompts.
11. If the Issue is still not resolved, see “Online Support Information” on page 189.

Random Loss of BIOS Settings

If the computer is experiencing intermittent loss of BIOS information, perform the following actions one at a time to correct the problem.

1. If the computer is more than one year old, replace the CMOS battery.
2. Run a complete virus scan using up-to-date software to ensure the computer is virus free.
3. If the computer is experiencing HDD or ODD BIOS information loss, disconnect and reconnect the power and data cables between devices.
If the BIOS settings are still lost, replace the cables.
4. If HDD information is missing from the BIOS, the drive may be defective and should be replaced.
5. Replace the Motherboard.
6. If the Issue is still not resolved, see “Online Support Information” on page 189.

LCD Failure

If the **LCD** fails, perform the following actions one at a time to correct the problem. Do not replace non-defective FRUs:

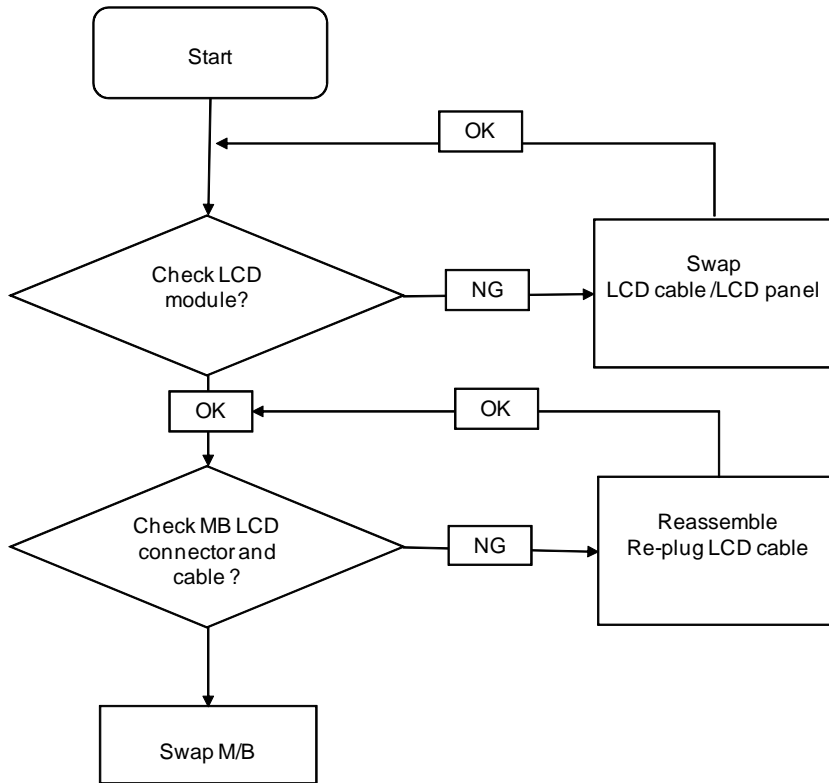

Built-In Keyboard Failure

If the built-in **Keyboard** fails, perform the following actions one at a time to correct the problem. Do not replace non-defective FRUs:

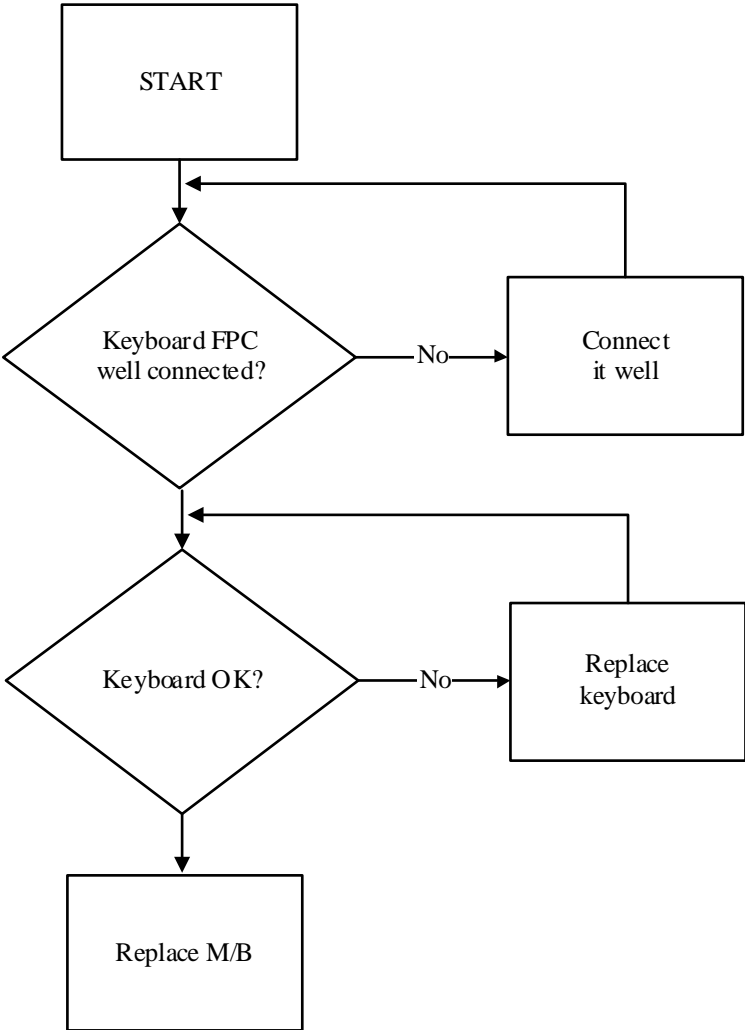

TouchPad Failure

If the **TouchPad** doesn't work, perform the following actions one at a time to correct the problem. Do not replace non-defective FRUs:

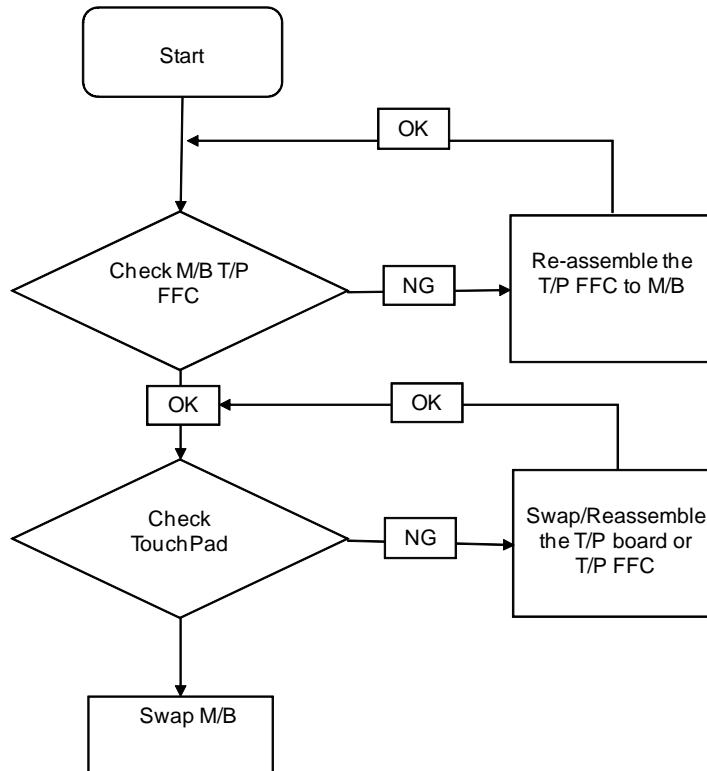

Internal Speaker Failure

If the internal **Speakers** fail, perform the following actions one at a time to correct the problem. Do not replace non-defective FRUs:

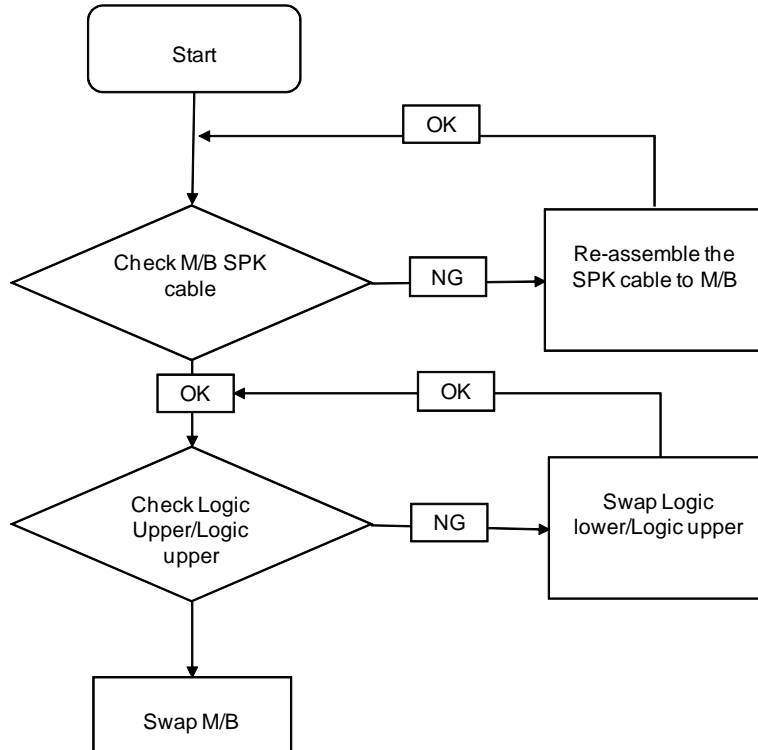

Sound Problems

If sound problems are experienced, perform the following actions one at a time to correct the problem.

1. Reboot the computer.
2. Navigate to **Start** → **Control Panel** → **System and Maintenance** → **System** → **Device Manager**. Check the Device Manager to determine that:
 - The device is properly installed.
 - There are no red Xs or yellow exclamation marks.
 - There are no device conflicts.
 - No hardware is listed under Other Devices.
3. Roll back the audio driver to the previous version, if updated recently.
4. Remove and reinstall the audio driver.
5. Ensure that all volume controls are set mid range:
 - a. Click the volume icon on the taskbar and drag the slider to 50. Ensure that the volume is not muted.
 - b. Click Mixer to verify that other audio applications are set to 50 and not muted.
6. Navigate to **Start** → **Control Panel** → **Hardware and Sound** → **Sound**. Ensure that Speakers are selected as the default audio device (green check mark).

NOTE: If Speakers does not show, right-click on the **Playback** tab and select **Show Disabled Devices** (clear by default).
7. Select Speakers and click **Configure** to start **Speaker Setup**. Follow the onscreen prompts to configure the speakers.
8. Remove and recently installed hardware or software.

-
9. Restore system and file settings from a known good date using **System Restore**.
If the issue is not fixed, repeat the preceding steps and select an earlier time and date.
 10. Reinstall the Operating System.
 11. If the Issue is still not resolved, see "Online Support Information" on page 189.

Internal Microphone Failure

If the internal **Microphone** fails, perform the following actions one at a time to correct the problem. Do not replace non-defective FRUs:

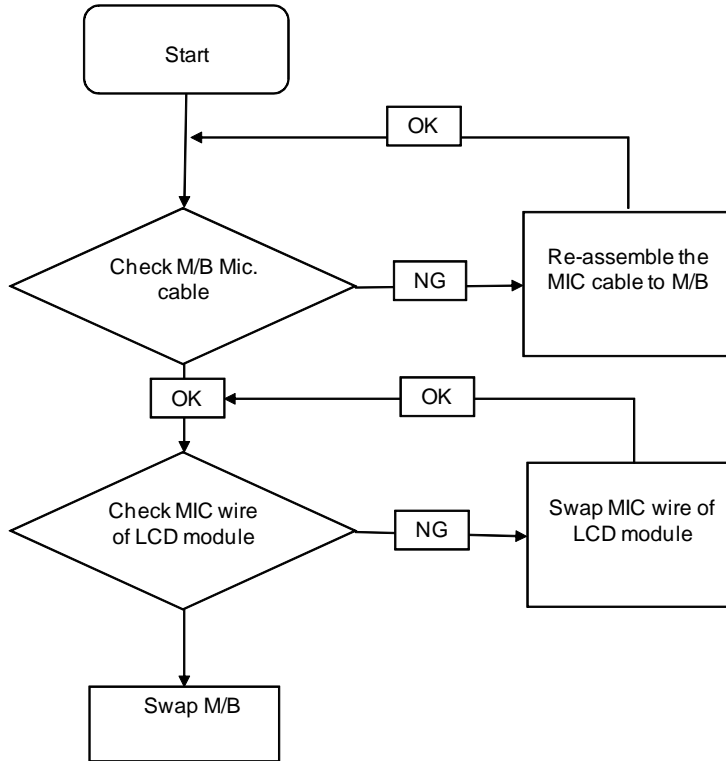

Microphone Problems

If internal or external **Microphones** do not operate correctly, perform the following actions one at a time to correct the problem.

1. Check that the microphone is enabled. Navigate to **Start** → **Control Panel** → **Hardware and Sound** → **Sound** and select the **Recording** tab.
2. Right-click on the **Recording** tab and select **Show Disabled Devices** (clear by default).
3. The microphone appears on the **Recording** tab.
4. Right-click on the microphone and select **Enable**.
5. Select the microphone then click **Properties**. Select the **Levels** tab.
6. Increase the volume to the maximum setting and click **OK**.
7. Test the microphone hardware:
 - a. Select the microphone and click **Configure**.
 - b. Select **Set up microphone**.
 - c. Select the microphone type from the list and click **Next**.
 - d. Follow the onscreen prompts to complete the test.
8. If the Issue is still not resolved, see "Online Support Information" on page 189.

HDD Not Operating Correctly

If the **HDD** does not operate correctly, perform the following actions one at a time to correct the problem.

1. Disconnect all external devices.
2. Run a complete virus scan using up-to-date software to ensure the computer is virus free.
3. Run the Windows Vista Startup Repair Utility:
 - a. insert the Windows Vista Operating System DVD in the ODD and restart the computer.
 - b. When prompted, press any key to start to the operating system DVD.
 - c. The **Install Windows** screen displays. Click **Next**.
 - d. Select **Repair your computer**.
 - e. The **System Recovery Options** screen displays. Click **Next**.
 - f. Select the appropriate operating system, and click **Next**.

NOTE: Click **Load Drivers** if controller drives are required.

- g. Select **Startup Repair**.
- h. Startup Repair attempts to locate and resolve issues with the computer.
- i. When complete, click **Finish**.

If an issue is discovered, follow the onscreen information to resolve the problem.

4. Run the Windows Memory Diagnostic Tool. For more information see Windows Help and Support.
5. Restart the computer and press F2 to enter the BIOS Utility. Check the BIOS settings are correct and that CD/DVD drive is set as the first boot device on the Boot menu.
6. Ensure all cables and jumpers on the HDD and ODD are set correctly.
7. Remove any recently added hardware and associated software.
8. Run the Windows Disk Defragmenter. For more information see Windows Help and Support.
9. Run Windows Check Disk by entering **chkdsk /r** from a command prompt. For more information see Windows Help and Support.
10. Restore system and file settings from a known good date using **System Restore**.

If the issue is not fixed, repeat the preceding steps and select an earlier time and date.
11. Replace the HDD. See "Disassembly Process" on page 42.

USB Failure (Right up/down side)

If the rightside **USB** port fails, perform the following actions one at a time to correct the problem. Do not replace non-defective FRUs:

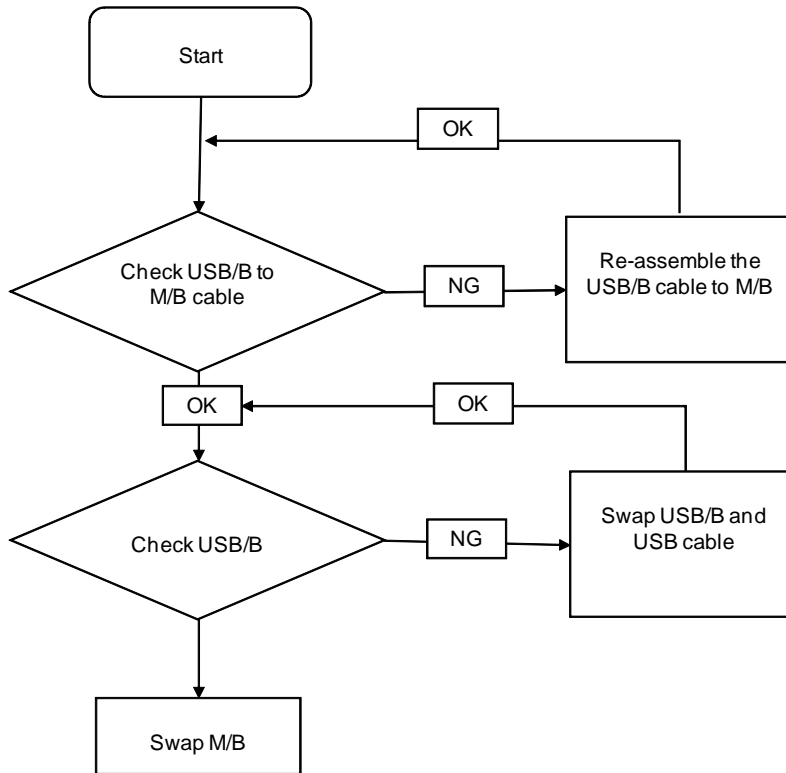

Modem Failure

If the modem fails, perform the following actions one at a time to correct the problem. Do not replace non-defective FRUs:

External Mouse Failure

If an external **Mouse** fails, perform the following actions one at a time to correct the problem.

1. Try an alternative mouse.
2. If the mouse uses a wireless connection, insert new batteries and confirm there is a good connection. See the mouse user manual.
3. If the mouse uses a USB connection, try an alternate USB port.
4. Try an alternative program to verify mouse operation. Reinstall the program experiencing mouse failure.
5. Restart the computer.
6. Remove any recently added hardware and associated software.
7. Remove any recently added software and reboot.
8. Restore system and file settings from a known good date using **System Restore**.

If the issue is not fixed, repeat the preceding steps and select an earlier time and date.

9. Run the Event Viewer to check the events log for errors. For more information see Windows Help and Support.
10. Roll back the mouse driver to the previous version if updated recently.
11. Remove and reinstall the mouse driver.
12. Check the Device Manager to determine that:
 - The device is properly installed. There are no red Xs or yellow exclamation marks.
 - There are no device conflicts.
 - No hardware is listed under Other Devices.
13. If the Issue is still not resolved, see "Online Support Information" on page 189.

Other Failures

If the CRT Switch, Dock, LAN Port, external MIC or Speakers, PCI Express Card, 5-in-1 Card Reader or Volume Wheel fail, perform the following general steps to correct the problem. Do not replace non-defective FRUs:

1. Check Drive whether is OK.
2. Check Test Fixture is ok.
3. Swap M/B to Try.

Intermittent Problems

Intermittent system hang problems can be caused by a variety of reasons that have nothing to do with a hardware defect, such as: cosmic radiation, electrostatic discharge, or software errors. FRU replacement should be considered only when a recurring problem exists.

When analyzing an intermittent problem, do the following:

1. Run the advanced diagnostic test for the system board in loop mode at least 10 times.
2. If no error is detected, do not replace any FRU.
3. If any error is detected, replace the FRU. Rerun the test to verify that there are no more errors.

Undetermined Problems

The diagnostic problems does not identify which adapter or device failed, which installed devices are incorrect, whether a short circuit is suspected, or whether the system is inoperative.

Follow these procedures to isolate the failing FRU (do not isolate non-defective FRU).

NOTE: Verify that all attached devices are supported by the computer.

NOTE: Verify that the power supply being used at the time of the failure is operating correctly. (See “Power On Issue” on page 138):

1. Power-off the computer.
2. Visually check them for damage. If any problems are found, replace the FRU.
3. Remove or disconnect all of the following devices:
 - Non-Acer devices
 - Printer, mouse, and other external devices
 - Battery pack
 - Hard disk drive
 - DIMM
 - CD-ROM/Diskette drive Module
 - PC Cards
4. Power-on the computer.
5. Determine if the problem has changed.
6. If the problem does not recur, reconnect the removed devices one at a time until you find the failing FRU.
7. If the problem remains, replace the following FRU one at a time. Do not replace a non-defective FRU:
 - System board
 - LCD assembly

POST Code Reference Tables

These tables describe the POST codes and components of the POST process.

Code	Beeps	POST Routine Description
02h		Verify Real Mode
03h		Disable Non-Maskable Interrupt (NMI)
04h		Get CPU type
06h		Initialize system hardware
08h		Initialize chipset with initial POST values
09h		Set IN POST flag
0Ah		Initialize CPU registers
0Bh		Enable CPU cache
0Ch		Initialize caches to initial POST values
0Eh		Initialize I/O component
0Fh		Initialize the local bus IDE
10h		Initialize Power Management
11h		Load alternate registers with initial POST values
12h		Restore CPU control word during warm boot
13h		Initialize PCI Bus Mastering devices
14h		Initialize keyboard controller
16h	1-2-2-3	BIOS ROM checksum
17h		Initialize cache before memory autosize
18h		8254 timer initialization
1Ah		8237 DMA controller initialization
1Ch		Reset Programmable Interrupt Controller
20h	1-3-1-1	Test DRAM refresh
22h	1-3-1-3	Test 8742 Keyboard Controller
24h		Set ES segment register to 4 GB
26h		Enable A20 line
28h		Autosize DRAM
29h		Initialize POST Memory Manager
2Ah		Clear 512 KB base RAM
2Ch	1-3-4-1	RAM failure on address line xxxx*
2Eh	1-3-4-3	RAM failure on data bits xxxx* of low byte of memory bus
2Fh		Enable cache before system BIOS shadow
30h	1-4-1-1	RAM failure on data bits xxxx* of high byte of memory bus
32h		Test CPU bus-clock frequency
33h		Initialize Phoenix Dispatch Manager
36h		Warm start shut down
38h		Shadow system BIOS ROM
3Ah		Autosize cache
3Ch		Advanced configuration of chipset registers
3Dh		Load alternate registers with CMOS values
42h		Initialize interrupt vectors

Code	Beeps	POST Routine Description
45h		POST device initialization
46h	2-1-2-3	Check ROM copyright notice
48h		Check video configuration against CMOS
49h		Initialize PCI bus and devices
4Ah		Initialize all video adapters in system
4Bh		QuietBoot start (optional)
4Ch		Shadow video BIOS ROM
4Eh		Display BIOS copyright notice
50h		Display CPU type and speed
51h		Initialize EISA board
52h		Test keyboard
54h		Set key click if enabled
58h	2-2-3-1	Test for unexpected interrupts
59h		Initialize POST display service
5Ah		Display prompt "Press F2 to enter SETUP"
5Bh		Disable CPU cache
5Ch		Test RAM between 512 and 640 KB
60h		Test extended memory
62h		Test extended memory address lines
64h		Jump to UserPatch1
66h		Configure advanced cache registers
67h		Initialize Multi Processor APIC
68h		Enable external and CPU caches
69h		Setup System Management Mode (SMM) area
6Ah		Display external L2 cache size
6Bh		Load custom defaults (optional)
6Ch		Display shadow-area message
6Eh		Display possible high address for UMB recovery
70h		Display error messages
72h		Check for configuration errors
76h		Check for keyboard errors
7Ch		Set up hardware interrupt vectors
7Eh		Initialize coprocessor if present
80h		Disable onboard Super I/O ports and IRQs
81h		Late POST device initialization
82h		Detect and install external RS232 ports
83h		Configure non-MCD IDE controllers
84h		Detect and install external parallel ports
85h		Initialize PC-compatible PnP ISA devices
86h		Re-initialize onboard I/O ports.
87h		Configure Motherboard Configurable Devices (optional)
88h		Initialize BIOS Data Area
89h		Enable Non-Maskable Interrupts (NMIs)

Code	Beeps	POST Routine Description
8Ah		Initialize Extended BIOS Data Area
8Bh		Test and initialize PS/2 mouse
8Ch		Initialize floppy controller
8Fh		Determine number of ATA drives (optional)
90h		Initialize hard-disk controllers
91h		Initialize local-bus hard-disk controllers
92h		Jump to UserPatch2
93h		Build MPTABLE for multi-processor boards
95h		Install CD ROM for boot
96h		Clear huge ES segment register
97h		Fixup Multi Processor table
98h	1-2	Search for option ROMs. One long, two short beeps on checksum failure
99h		Check for SMART Drive (optional)
9Ah		Shadow option ROMs
9Ch		Set up Power Management
9Dh		Initialize security engine (optional)
9Eh		Enable hardware interrupts
9Fh		Determine number of ATA and SCSI drives
A0h		Set time of day
A2h		Check key lock
A4h		Initialize Typematic rate
A8h		Erase F2 prompt
AAh		Scan for F2 key stroke
ACh		Enter SETUP
A Eh		Clear Boot flag
B0h		Check for errors
B2h		POST done - prepare to boot operating system
B4h	1	One short beep before boot
B5h		Terminate QuietBoot (optional)
B6h		Check password (optional)
B9h		Prepare Boot
BAh		Initialize DMI parameters
BBh		Initialize PnP Option ROMs
BCh		Clear parity checkers
BDh		Display MultiBoot menu
BEh		Clear screen (optional)
BFh		Check virus and backup reminders
C0h		Try to boot with INT 19
C1h		Initialize POST Error Manager (PEM)
C2h		Initialize error logging
C3h		Initialize error display function
C4h		Initialize system error handler
C5h		PnPnd dual CMOS (optional)

Code	Beeps	POST Routine Description
C6h		Initialize notebook docking (optional)
C7h		Initialize notebook docking late
C8h		Force check (optional)
C9h		Extended checksum (optional)
D2h		Unknown interrupt

Code	Beeps	For Boot Block in Flash ROM
E0h		Initialize the chipset
E1h		Initialize the bridge
E2h		Initialize the CPU
E3h		Initialize system timer
E4h		Initialize system I/O
E5h		Check force recovery boot
E6h		Checksum BIOS ROM
E7h		Go to BIOS
E8h		Set Huge Segment
E9h		Initialize Multi Processor
EAh		Initialize OEM special code
EBh		Initialize PIC and DMA
ECh		Initialize Memory type
EDh		Initialize Memory size
EEh		Shadow Boot Block
EFh		System memory test
F0h		Initialize interrupt vectors
F1h		Initialize Run Time Clock
F2h		Initialize video
F3h		Initialize System Management Mode
F4h	1	Output one beep before boot
F5h		Boot to Mini DOS
F6h		Clear Huge Segment
F7h		Boot to Full DOS

* If the BIOS detects error 2C, 2E, or 30 (base 512K RAM error), it displays an additional word-bitmap (xxxx) indicating the address line or bits that failed. For example, "2C 0002" means address line 1 (bit one set) has failed. "2E 1020" means data bits 12 and 5 (bits 12 and 5 set) have failed in the lower 16 bits. Note that error 30 cannot occur on 386SX systems because they have a 16 rather than 32-bit bus. The BIOS also sends the bitmap to the port-80 LED display. It first displays the check point code, followed by a delay, the high-order byte, another delay, and then the low-order byte of the error. It repeats this sequence continuously.

Each SmmDriver entry point used in 80_PORT

Code	Description
0xD4	SMM_ACCESS
0xDE	SMM_CONTROL
0xCC	SMM_BASE
0xD2	SMM_RUNTIME
0xDF	SB_SMM_DISPATCH
0xD0	SMM_THUNK
0xCA	SMM_ACPI_SW_CHILD
0xFE	SMM_PLATFORM
0xD8	SMM_GMCH_MBI
0x90	SMM_FW_BLOCK_SERVICE
0x91	SMM_VARIABLE
0x92	SMM_IHISI
0x93	SMM_INT15_MICROCODE
0x94	SMM_PNP
0x95	SMM_INIT_PPM
0xD3	SMM_OEM_SERVICE

Jumper and Connector Locations

Top View

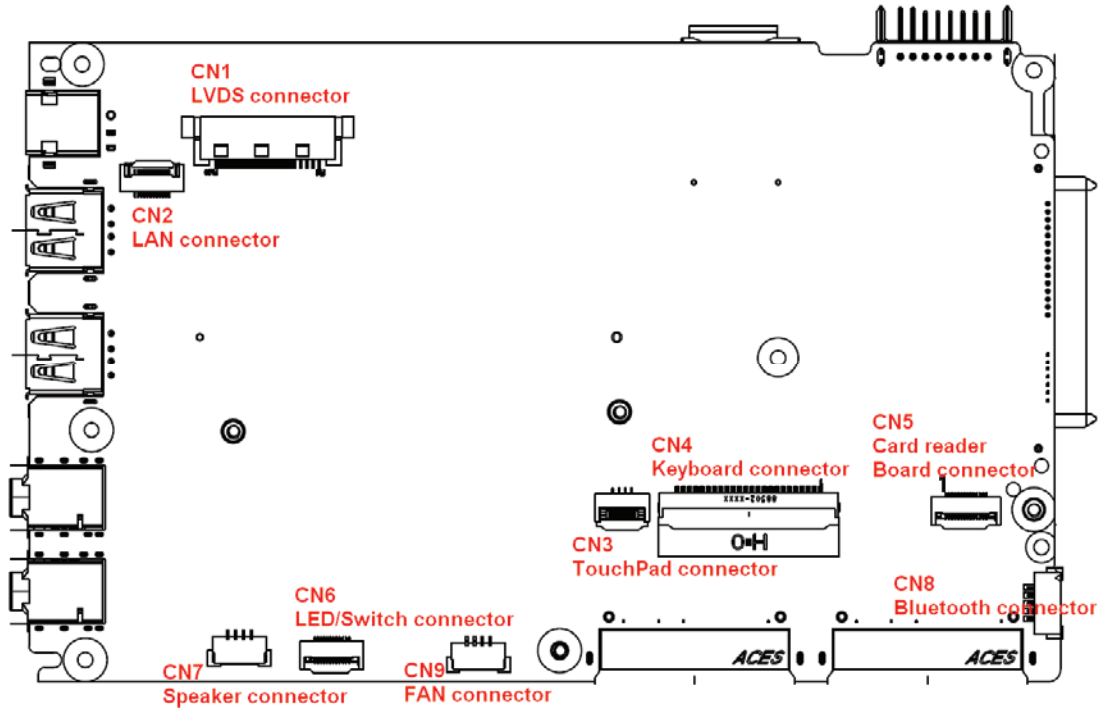

Item	Description	Item	Description
CN1	LVDS connector	CN6	LED/Switch connector
CN2	LAN connector	CN7	Speaker connector
CN3	Touchpad connector	CN8	Bluetooth connector
CN4	Keyboard connector	CN9	Fan connector
CN5	Card reader board connector		

Bottom View

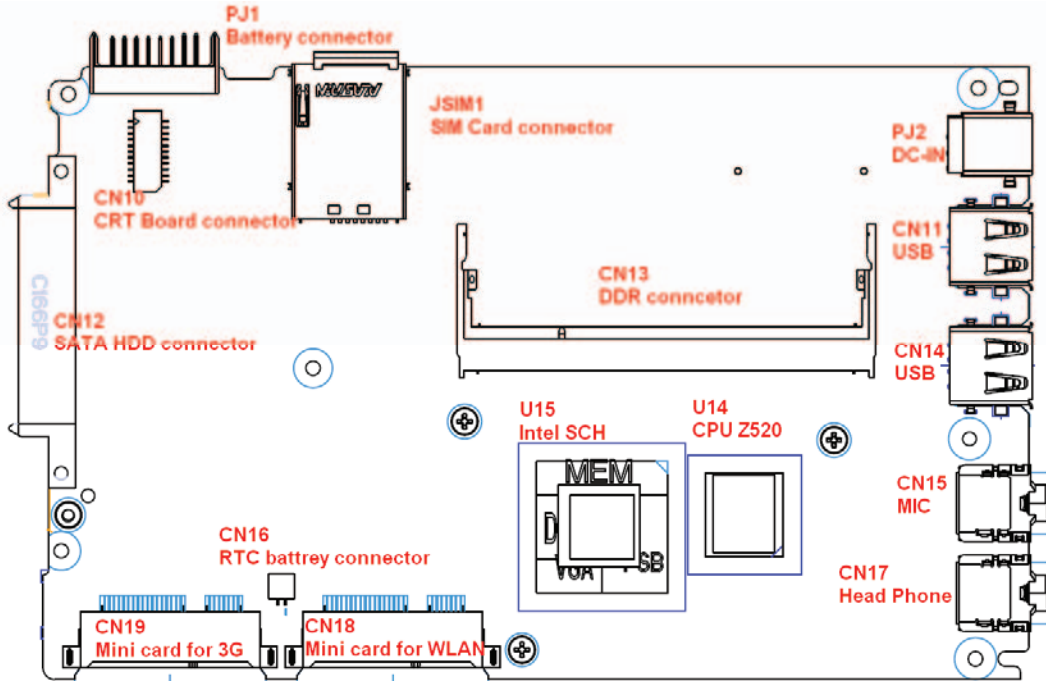

Item	Description	Item	Description
PJ1	Battery connector	CN16	RTC battery connector
PJ2	DC-in connector	CN17	Headphone connector
CN10	CRT board connector	CN18	Mini card for WLAN
CN11	USB connector	CN19	Mini card for 3G
CN12	SATA HDD connector	JSIM1	SIM card connector
CN13	DDR connector	U14	CPU Z520
CN14	USB connector	U15	Intel SCH
CN15	MIC connector		

Clearing Password Check and BIOS Recovery

This section provide you the standard operating procedures of clearing password and BIOS recovery for Aspire one. Aspire one provides one Hardware Open Gap on the main board for clearing the CMOS, and one Hotkey for enabling BIOS Recovery.

Motherboard CMOS Discharge

Discharging the CMOS clears all user settings.

1. Decompose the NB and take out the Main Board Locate the RTC Battery and Jumpers.

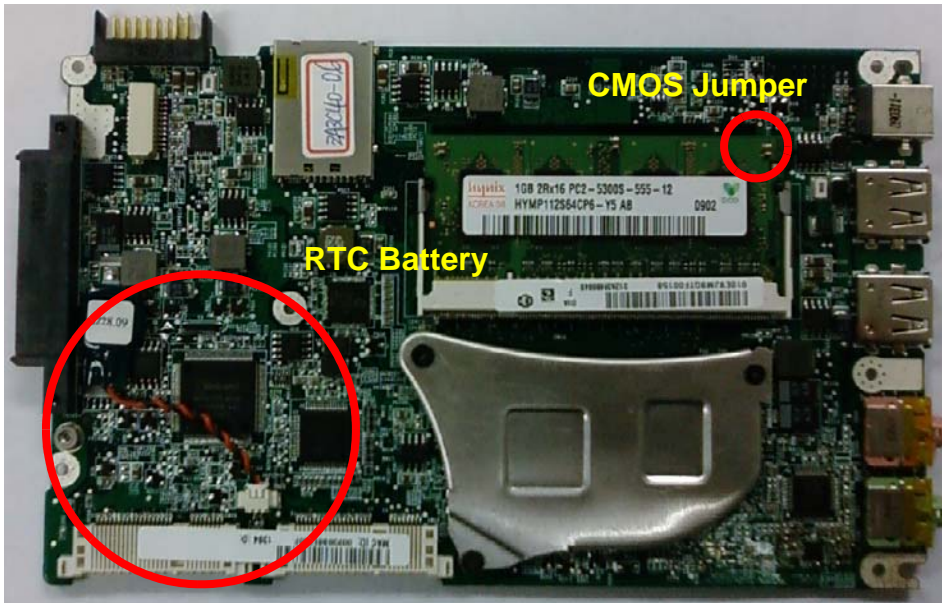

2. Disconnect the RTC battery

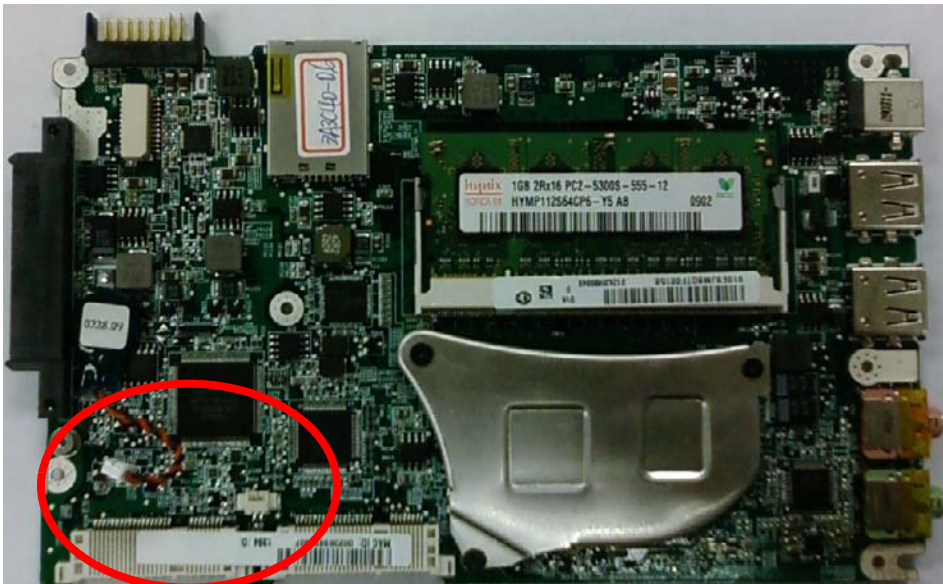

-
3. Remove the SDRAM module and short the G2 pad.

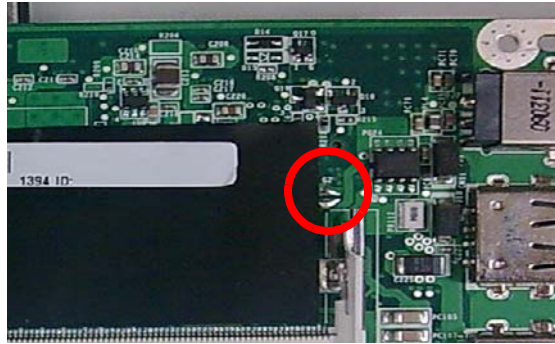

4. Reconnect the TRTC battery and reassemble the unit.

BIOS Recovery by Crisis Disk

BIOS Recovery Boot Block:

BIOS Recovery Boot Block is a special block of BIOS. It is used to boot up the system with minimum BIOS initialization. Users can enable this feature to restore the BIOS firmware to a successful one once the previous BIOS flashing process failed.

BIOS Recovery Hotkey:

The system provides a function hotkey: **Fn+Esc**, for enable BIOS Recovery process when system is powered on during BIOS POST. To use this function, it is strongly recommended to have the AC adapter and Battery present. If this function is enabled, the system will force the BIOS to enter a special BIOS block, called Boot Block.

Steps for BIOS Recovery by USB Flash Crisis Disk:

Before doing this, a Crisis Diskette should be prepared ready in hand. The Crisis Diskette could be made by executing the Crisis Disk program in another system with Windows XP OS.

Follow the steps below:

1. Plug in the USB disk.
2. Launch the **wincris.exe** program to create a USB Crisis Disk. Click **Start** to initiate the process.
3. Select the **Quick Format** option to format the disk and click **Start**. Follow the instructions on the screen to create the disk.
4. Copy the **KAV60.fd** BIOS file into USB flash disk root directory.

NOTE: Do not place any other *.fd file in the USB flash disk root directory.

To use the Crisis USB key, do the following:

1. Plug USB storage into USB port.
2. Press **Fn + ESC** button then plug in AC power.
The Power button flashes orange once.
3. Press **Power** button to initiate system CRISIS mode.
When CRISIS is complete, the system auto restarts with a workable BIOS.
4. Update the latest version BIOS for this machine by regular BIOS flashing process.

FRU (Field Replaceable Unit) List

This chapter gives you the FRU (Field Replaceable Unit) listing in global configurations of Aspire one. Refer to this chapter whenever ordering for parts to repair or for RMA (Return Merchandise Authorization).

Please note that WHEN ORDERING FRU PARTS, you should check the most up-to-date information available on your regional web or channel. For whatever reasons a part number change is made, it will not be noted on the printed Service Guide. For ACER AUTHORIZED SERVICE PROVIDERS, your Acer office may have a DIFFERENT part number code from those given in the FRU list of this printed Service Guide. You MUST use the local FRU list provided by your regional Acer office to order FRU parts for repair and service of customer machines.

NOTE: To scrap or to return the defective parts, you should follow the local government ordinance or regulations on how to dispose it properly, or follow the rules set by your regional Acer office on how to return it.

Aspire one Exploded Diagrams

Main Assembly

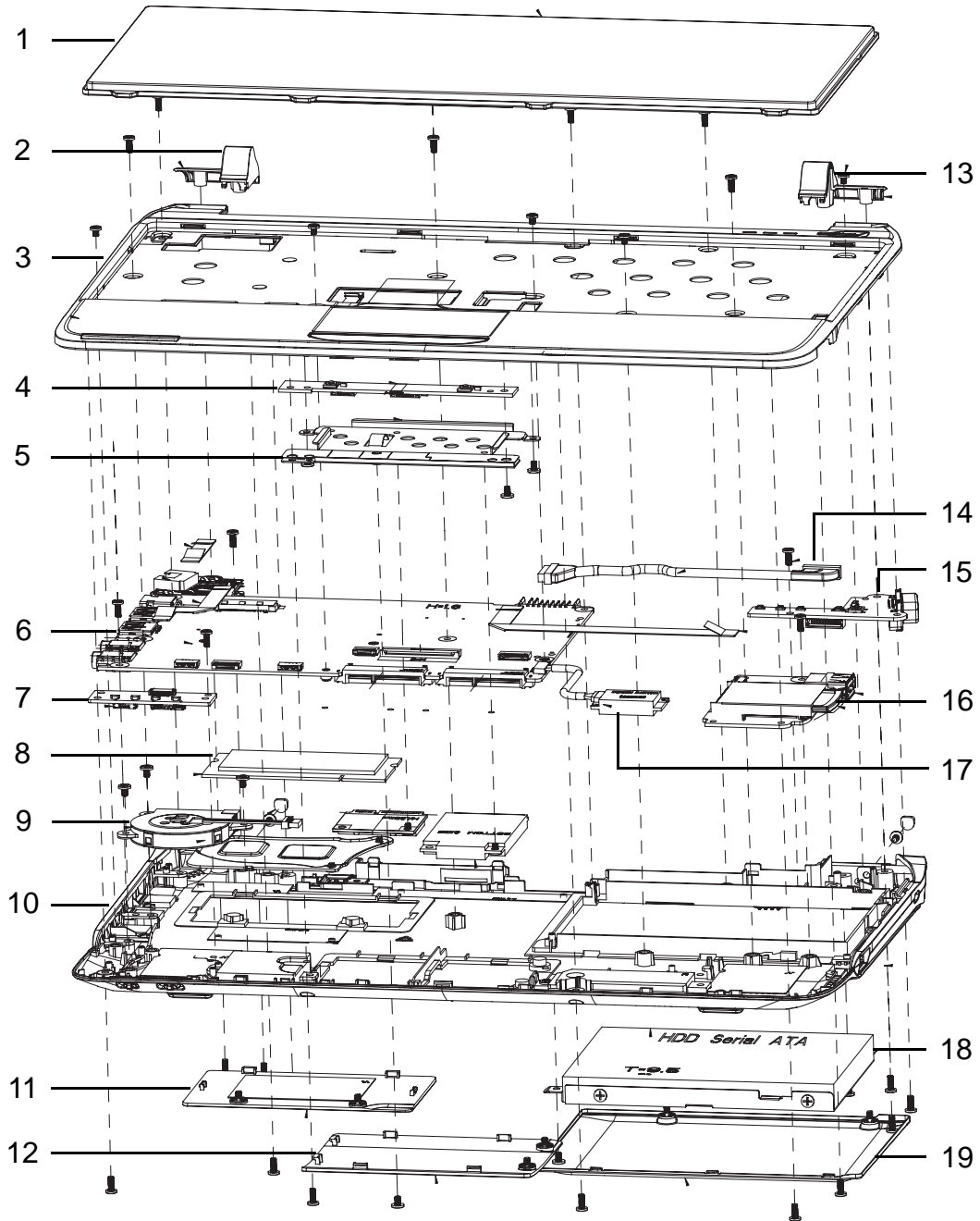

Item	Description	Part Number	Item	Description	Part Number
1	Keyboard		11	Memory Door	
2	Hinge Cover_L		12	MiniPCI Door	
3	Upper Cover		13	Hinge Cover_R	
4	Button Board		14	CRT Cable	
5	TouchPad Bracket		15	CRT Board	
6	Mainboard		16	Card Reader Board	

Item	Description	Part Number	Item	Description	Part Number
7	LED Board		17	Bluetooth Module	
8	Memory Module		18	HDD	
9	CPU Fan		19	HDD Door	
10	Lower Cover				

LCD Assembly

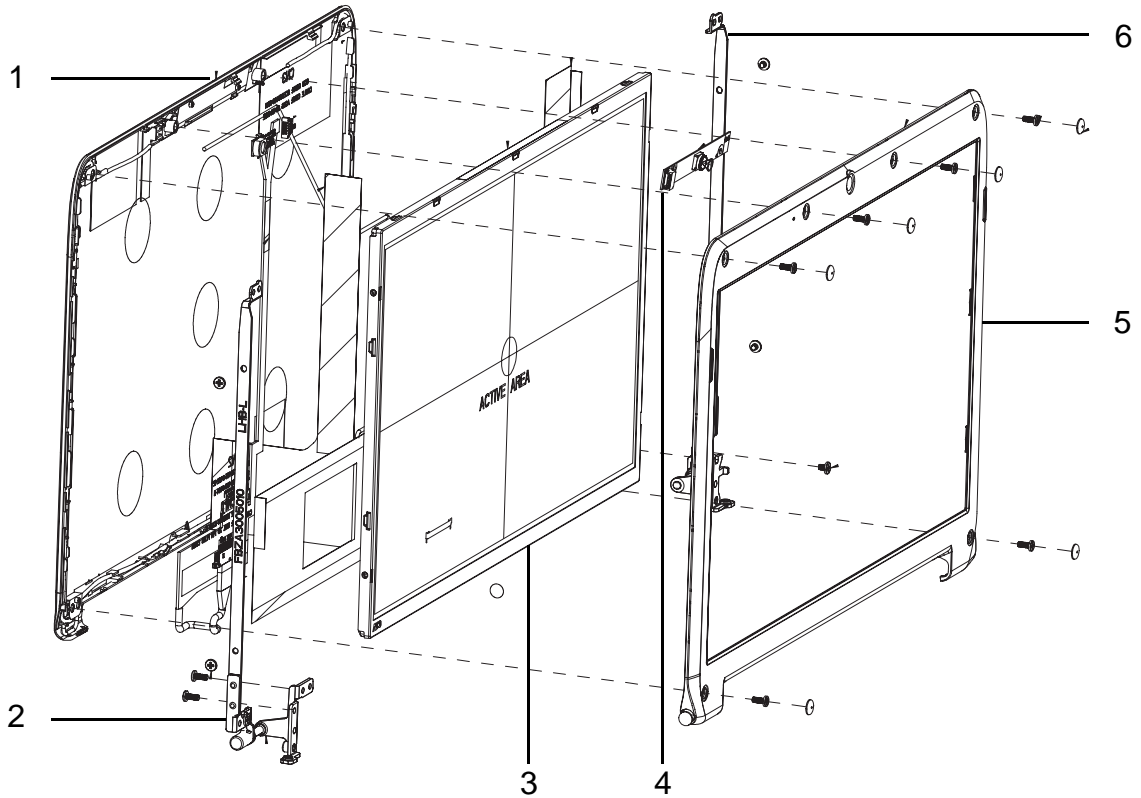

Item	Description	Part Number
1	LCD Module	TBD
2	LCD Bracket_L	TBD
3	LCD Panel	TBD
4	Camera	57.S6507.001
5	LCD Bezel	TBD
6	LCD Bracket_R	TBD

Aspire one FRU List

Category	Description	Acer P/N
ADAPTER		
	ADAPTER DELTA 30W 19V 1.7X5.5X11 BLACK ADP-30JH BA LF	AP.03001.001
	ADAPTER LITE-ON 30W 1.7X5.5X11 BLACK PA-1300-04AC LF	AP.03003.001
	ADAPTER HIPRO 30W 19V 1.7X5.5X11 BLACK HP-A0301R3 B1LF LF	AP.0300A.001
BATTERY		
	Battery SIMPLO UM-2009A Li-Ion 3S1P PANASONIC 3 cell 2200mAh Main COMMON black, Panasonic 2.2CG	BT.00307.013
	Battery SIMPLO UM-2009A Li-Ion 3S1P SAMSUNG 3 cell 2200mAh Main COMMON black, SDI 2.2F	BT.00307.014
	Battery SIMPLO UM-2009A Li-Ion 3S1P LGC 3 cell 2200mAh Main COMMON black, LGC 2.2 S3	BT.00307.015
	Battery SONY UM-2009A Li-Ion 3S1P SONY 3 cell 2200mAh Main COMMON black	TBD
	Battery SANYO UM-2009A Li-Ion 3S1P SANYO 3 cell 2200mAh Main COMMON black	TBD
	Battery PANASONIC UM-2009A Li-Ion 3S1P PANASONIC 3 cell 2200mAh Main COMMON 2.2CG	TBD
	Battery SIMPLO UM-2009B Li-Ion 3S2P SAMSUNG 6 cell 5200mAh Main COMMON Black, SDI 2.6 C	BT.00607.074
	Battery SIMPLO UM-2009B Li-Ion 3S2P LGC 6 cell 5200mAh Main COMMON Black, LGC 2.6 B3	BT.00607.075
	Battery PANASONIC UM-2009B Li-Ion 3S2P PANASONIC 6 cell 5800mAh Main COMMON black	BT.00605.039
	Battery SIMPLO UM-2009AW Li-Ion 3S1P PANASONIC 3 cell 2200mAh Main COMMON white, Panasonic 2.2CG	BT.00307.016
BOARD		
	Option 3G GTM382EL	LC.21300.007
	3G UNDP-1	LC.21300.005
	Foxconn Wireless LAN Atheros HB63 BG (HM)	NI.23600.048
	Lan Intel WLAN 512ANXMMWG Echo Peak 5150 MM#895364	KI.EPM01.003
	BLUETOOTH MODULE (T60H928.11)	BT.21100.005
	LED/B ASSY(3G.BT) S.P	TBD
	LED/B ASSY(BT) S.P	TBD
	LED/B ASSY(WO 3G/BT) S.P	TBD
	CRT/B ASSY S.P	TBD
	LAN/B ASSY S.P	TBD
	CR/B ASSY S.P	TBD
	TP/B ASSY S.P	TBD
CCD		
	Suyin Camera Rosa 2G, MODULE CN0316-S30C-OV06-1	57.S6507.001
	Liteon CAMERA MODULE 09P2SF001(CMOS,0.3M,VGA)	TBD
CABLE		

Category	Description	Acer P/N
	PWR CORD V943B30001218008 DANISH 3P	27.A03V7.006
	PWR CORD(ISR)1.8M 3PBLK FZ0I0008-038	27.TATV7.005
	PWR CORD V50CB3T3012180QD TW-110V,3P	27.A99V7.002
	POWER CORD(SWI)1.8M 3PBLACK FZ010008-011	27.A99V7.004
	POWER CORD(IT) 1.8M 3PBLACK FZ010008-008	27.A99V7.005
	POWER CORD(S.A) 1.8M 3BLACK FZ010008-006	27.T48V7.001
	POWER CORD US 3PIN ROHS	27.TAXV7.001
	POWER CORD(EU) 1.8M 3PBLACK FM010008-010	27.TATV7.001
	POWER CORD(UK) 1.8M 3PBLACK FP010008-013	27.TATV7.003
	POWER CORD BRAZIL IMETRO 3 PIN	27.S0607.001
	POWER CORD(S.A) 1.8M 3BLACK FZ010008-006	27.T48V7.001
	POWER CORD UK 3PIN	27.A03V7.004
	CABLE ASSY LCD 11.6 3V S.P	TBD
	CABLE ASSY BLUETOOTH S.P	TBD
	CABLE ASSY CRT S.P	TBD
	CABLE FFC LED 5V S.P	TBD
	CABLE FFC LAN 5V S.P	TBD
	CABLE FFC CARDREAD 5V S.P	TBD
CASE/COVER/BRACKET ASSEMBLY		
	LCD COVER ASSY-BK S.P	TBD
	LCD COVER 3G ASSY-BK S.P	TBD
	LCD COVER ASSY-WH S.P	TBD
	LCD COVER 3G ASSY-WH S.P	TBD
	LCD COVER SUB ASSY-BLUE S.P	TBD
	LCD COVER 3G SUB ASSY-BLUE S.P	TBD
	LCD COVER SUB ASSY-RED S.P	TBD
	LCD COVER 3G SUB ASSY-RED S.P	TBD
	LCD COVER SUB ASSY-PINK S.P	TBD
	LCD COVER 3G SUB ASSY-PINK S.P	TBD
	LCD COVER SUB ASSY-BK_UV S.P	TBD
	LCD COVER 3G SUB ASSY-BK_UV S.P	TBD
	LCD COVER SUB ASSY-WH_UV	TBD
	LCD COVER 3G SUB ASSY-WH_UV	TBD
	LCD COVER SUB ASSY-BLUE_UV	TBD
	LCD COVER 3G SUB ASSY-BLUE_UV	TBD
	LCD COVER SUB ASSY-RED_UV	TBD
	LCD COVER 3G SUB ASSY-RED_UV	TBD
	LCD COVER SUB ASSY-PINK_UV	TBD
	LCD COVER 3G SUB ASSY-PINK_UV	TBD
	LCD BEZEL ASSY-BK S.P	TBD
	LCD BEZEL ASSY-WH S.P	TBD

Category	Description	Acer P/N
	TOP BT SUB ASSY-BK S.P	TBD
	TOP 3G BT SUB ASSY-BK S.P	TBD
	TOP SUB ASSY-BK S.P	TBD
	TOP 3G SUB ASSY-BK S.P	TBD
	TOP BT SUB ASSY-SILVER S.P	TBD
	TOP 3G BT SUB ASSY-SILVER S.P	TBD
	TOP SUB ASSY-SILVER S.P	TBD
	TOP 3G SUB ASSY-SILVER S.P	TBD
	TOP BT SUB ASSY-BLUE S.P	TBD
	TOP 3G BT SUB ASSY-BLUE S.P	TBD
	TOP SUB ASSY-BLUE S.P	TBD
	TOP 3G SUB ASSY-BLUE S.P	TBD
	TOP SUB ASSY-RED S.P	TBD
	TOP 3G SUB ASSY-RED S.P	TBD
	TOP BT SUB ASSY-RED S.P	TBD
	TOP 3G BT SUB ASSY-RED S.P	TBD
	TOP SUB ASSY-PINK	TBD
	TOP 3G SUB ASSY-PINK	TBD
	TOP BT SUB ASSY-PINK	TBD
	TOP 3G BT SUB ASSY-PINK	TBD
	BASE WF ASSY-BK S.P	TBD
	BASE BT WF ASSY-BK S.P	TBD
	BASE WF ASSY-WH S.P	TBD
	BASE BT WF ASSY-WH S.P	TBD
	BASE WF ASSY-BK WO/3G S.P	TBD
	BASE BT WF ASSY-BK WO/3G S.P	TBD
	BASE WF ASSY-WH WO/3G S.P	TBD
	BASE BT WF ASSY-WH WO/3G S.P	TBD
	HDD DOOR ASSY-BK S.P	TBD
	HDD DOOR ASSY-WH S.P	TBD
	RAM DOOR ASSY-BK S.P	TBD
	RAM DOOR ASSY-WH S.P	TBD
	3G CARD DOOR ASSY-BK S.P	TBD
	3G CARD DOOR ASSY-WH S.P	TBD
	HINGE-R S.P	TBD
	HINGE-L S.P	TBD
	HINGE COVER L BK S.P	TBD
	HINGE COVER L SILVER S.P	TBD
	HINGE COVER L RED S.P	TBD
	HINGE COVER L BLUE S.P	TBD
	HINGE COVER L PINK S.P	TBD

Category	Description	Acer P/N
	HINGE COVER R BK S.P	TBD
	HINGE COVER R SILVER S.P	TBD
	HINGE COVER R RED S.P	TBD
	HINGE COVER R BLUE S.P	TBD
	HINGE COVER R PINK S.P	TBD
	TP BRACKET S.P	TBD
SATA HDD/HARD DISK DRIVE		
	HDD SEAGATE 2.5" 5400rpm 160GB ST9160310AS Crockett SATA LF F/W:0303	KH.16001.034
	HDD TOSHIBA 2.5" 5400rpm 160GB MK1655GSX Libra SATA LF F/W: FG011J	KH.16004.006
	HDD WD 2.5" 5400rpm 160GB WD1600BEVT-22ZCTO ML160 SATA LF F/W:11.01A11	KH.16008.022
	HDD SEAGATE 2.5" 5400rpm 250GB ST9250315AS Wyatt SATA LF F/W:0001SDM1	KH.25001.016
	HDD HGST 2.5" 5400rpm 160GB HTS545016B9A300 Panther B SATA LF F/W:C60F	KH.16007.024
	HDD(160G)HTS543216L9SA00 S.P	TBD
	HDD HGST 2.5" 5400rpm 160GB HTS543216L9A300 Falcon-B SATA LF F/W:C40C	TBD
	HDD HGST 2.5" 5400rpm 250GB HTS543225L9A300 Falcon-B SATA LF F/W:C40C	KH.25007.013
	HDD WD 2.5" 5400rpm 250GB WD2500BEVT-22ZCT0 ML160 SATA LF F/W:11.01A11	KH.25008.021
	HDD HGST 2.5" 5400rpm 250GB HTS545025B9A300 Panther B SATA LF F/W:C60F	KH.25007.015
	HDD TOSHIBA 2.5" 5400rpm 250GB MK2555GSX Libra SATA LF F/W:FG001J	KH.25004.003
	HDD-BKT S.P	TBD
KEYBOARD		
	K/B(GREEK) BLACK S.P	TBD
	K/B(TAIWAN) BLACK S.P	TBD
	K/B(THAI) BLACK S.P	TBD
	K/B(HEBREW) BLACK S.P	TBD
	K/B(KOREA) BLACK S.P	TBD
	K/B(ARAB-EN) BLACK S.P	TBD
	K/B(UI) BLACK S.P	TBD
	K/B(RUSSIAN) BLACK S.P	TBD
	K/B(CHINA) BLACK S.P	TBD
	K/B(UK) BLACK S.P	TBD
	K/B(SWEDISH) BLACK S.P	TBD
	K/B(FRENCH) BLACK S.P	TBD
	K/B(PORTUGUESE) BLACK S.P	TBD
	K/B(DUTCH) BLACK S.P	TBD
	K/B(BRAZIL) BLACK S.P	TBD
	K/B(SWISS) BLACK S.P	TBD

Category	Description	Acer P/N
	K/B(POLAND) BLACK S.P	TBD
	K/B(DANISH) BLACK S.P	TBD
	K/B(ITALIAN) BLACK S.P	TBD
	K/B(BELGIUM) BLACK S.P	TBD
	K/B(GERMAN) BLACK S.P	TBD
	K/B(SLOVAK) BLACK S.P	TBD
	K/B(CZECH) BLACK S.P	TBD
	K/B(FRA-EN CAN) BLACK S.P	TBD
	K/B(CROATIAN) BLACK S.P	TBD
	K/B(FRA-CAN) BLACK S.P	TBD
	K/B(CZ-SLOVAK) BK S.P	TBD
	K/B(NORWEGIAN) BLACK S.P	TBD
	K/B(HUNGARIAN) BLACK S.P	TBD
	K/B(SPANISH) BLACK S.P	TBD
	K/B(LA) BLACK S.P	TBD
	K/B(ICELAND) BLACK S.P	TBD
	K/B(TURKISH) BLACK S.P	TBD
	K/B(NORDICS) BLACK S.P	TBD
	K/B(ARAB-FR) BLACK S.P	TBD
	K/B(JAP) BLACK S.P	TBD
	PERSIAN(FARSI)	TBD
	ROMANIAN	TBD
	SLOVENIA	TBD
	BULGARIAN	TBD
	TURKISH	TBD
LCD		
	LED LCD AUO 11.6" WXGA Glare B116XW02 V0 LF 200nit 8ms 500:1	TBD
	LED LCD CMO 11.6" WXGA Glare N116B6-L02 LF 200nit 10ms 500:1	TBD
	LED LCD SAMSUNG 11.6" WXGA Glare LTN116AT01-A01 LF 200nit 8ms	TBD
	LED LCD LPL 11.6" WXGA Glare LP116WH1-TLA1 LF 200nit 8ms 500:1	TBD
MAINBOARD		
	MB ASSY(1.33G/3G/BT) S.P	TBD
	MB ASSY(1.33G/BT) S.P	TBD
	MB ASSY(1.33G/WO 3G/BT) S.P	TBD
	MB ASSY(1.60G/BT/WO 3G) S.P	TBD
	MB ASSY(1.60G/3G/BT) S.P	TBD
	MB(1.60G/WO 3G/BT) S.P	TBD
MEMORY		

Category	Description	Acer P/N
	Memory NANYA SO-DIMM DDRII 667 1GB NT1GT64UH8D0FN-3C LF 64*16 0.07um	KN.1GB03.026
	Memory SAMSUNG SO-DIMM DDRII 667 1GB M470T2864EH3-CE6 LF 64*16 0.055um	TBD
	Memory SAMSUNG SO-DIMM DDRII 667 512MB M470T6464QZ3-CE6 LF	KN.5120B.026
	Memory SAMSUNG SO-DIMM DDRII 667 512MB M470T6464QZ3-CE6 LF	KN.5120B.026
	Memory HYNIX SO-DIMM DDRII 667 512MB HYMP164S64CP6-Y5 LF	KN.5120G.024
	Memory ELPIDA SO-DIMM DDRII 667 1GB EBE11UE6AESA-6E-F LF 64*16 0.065um	KN.1GB09.010
	Memory ELPIDA SO-DIMM DDRII 667 1GB EBE11UE6ACUA-6E-E LF 64*16 0.065um	KN.1GB09.008
	Memory HYNIX SO-DIMM DDRII 667 1GB HMP112S6EFR6C-Y5 LF 64*16 0.055um	TBD
	Memory NANYA SO-DIMM DDRII 667 2GB NT2GT64U8HD0BN-3C LF	KN.2GB03.011
	Memory SAMSUNG SO-DIMM DDRII 667 2GB M470T5663EH3-CE6 LF 128*8 0.055um	KN.2GB0B.011
	Memory HYNIX SO-DIMM DDRII 667 2GB HMP125S6EFR8C-Y5 LF 128*8 0.055um	KN.2GB0G.012
	MEMORY HYNIX SO-DIMM DDRII 667 2GB HYMP125S64CP8-Y5 LF	KN.2GB0G.004
HEATSINK		
	HEATSINK ASSY	TBD
	FAN MODULE	TBD
MISCELLANEOUS		
	RUBBER HIGE SCW HOLE BK S.P	TBD
	LCD-BEZEL-RUBBER-U-ZG5 S.P	TBD
	LCD PANEL 3G AL-FOIL S.P	TBD
	LCD PANEL 3G AL-FOIL-A S.P	TBD
	LCD BEZEL RUBBER-U ZA3(GAZA3004,REV3A)	TBD
	LCD BEZEL RUBBER DOWN-U ZA3(GAZA3005,R3A)	TBD
	RUBBER FOOT FRONT ZA3(GAZA3007,R3A)BK	TBD
	RUBBER FOOT BACK ZA3(GAZA3008,R3A)BK	TBD

Screw List

Category	Description	Acer P/N
Screw		
	M2*5-I(BZN)(NYLOK)	86.TG607.004
	M2.0*2.5-I(BUWZN)	86.TPK07.001
	M2.0*3.0-I-NI-NYLOK IRON S.P	TBD
	M2.0*5.0-I(NI)	86.S0207.002
	M2.0*3.0-I(BKAG)(NYLOK) IRON	TBD
	2.0*4.0	86.W0107.003
	M2.0*4-I(BZN)(NYLOK)IRON	86.S6507.003
	M3*0.5+3.5I IRON S.P	TBD
	M2.0*2,I,NI,NYLOK IRON S.P	TBD

Model Definition and Configuration

Aspire one Series

Test Compatible Components

This computer's compatibility is tested and verified by Acer's internal testing department. All of its system functions are tested under Windows® XP Home, Windows® XP Pro environment.

Refer to the following lists for components, adapter cards, and peripherals which have passed these tests. Regarding configuration, combination and test procedures, please refer to the Aspire one series Compatibility Test Report released by the Acer Mobile System Testing Department.

Windows XP Environment Test

BRAND	Type	Description
3G		
	UNDP-1	3G UNDP-1
Option	GTM382E	Option 3G GTM382EL
	UNDP-1	3G UNDP-1
Option	GTM382E	Option 3G GTM382EL
	UNDP-1	3G UNDP-1
Option	GTM382E	Option 3G GTM382EL
	UNDP-1	3G UNDP-1
Option	GTM382E	Option 3G GTM382EL
Adapter		
DELTA	30W	Adapter DELTA 30W 19V 1.7x5.5x11 Black ADP-30JH BA LF
LITE-ON	30W	Adapter LITE-ON 30W 19V 1.7x5.5x11 Black PA-1300-04AC LF
HIPRO	30W	Adapter HIPRO 30W 19V 1.7x5.5x11 Black HP-A0301R3 B1LF LF
DELTA	30W	Adapter DELTA 30W 19V 1.7x5.5x11 Black ADP-30JH BA LF
LITE-ON	30W	Adapter LITE-ON 30W 19V 1.7x5.5x11 Black PA-1300-04AC LF
HIPRO	30W	Adapter HIPRO 30W 19V 1.7x5.5x11 Black HP-A0301R3 B1LF LF
DELTA	30W	Adapter DELTA 30W 19V 1.7x5.5x11 Black ADP-30JH BA LF
LITE-ON	30W	Adapter LITE-ON 30W 19V 1.7x5.5x11 Black PA-1300-04AC LF
HIPRO	30W	Adapter HIPRO 30W 19V 1.7x5.5x11 Black HP-A0301R3 B1LF LF
DELTA	30W	Adapter DELTA 30W 19V 1.7x5.5x11 Black ADP-30JH BA LF
LITE-ON	30W	Adapter LITE-ON 30W 19V 1.7x5.5x11 Black PA-1300-04AC LF
HIPRO	30W	Adapter HIPRO 30W 19V 1.7x5.5x11 Black HP-A0301R3 B1LF LF
DELTA	30W	Adapter DELTA 30W 19V 1.7x5.5x11 Black ADP-30JH BA LF
LITE-ON	30W	Adapter LITE-ON 30W 19V 1.7x5.5x11 Black PA-1300-04AC LF
HIPRO	30W	Adapter HIPRO 30W 19V 1.7x5.5x11 Black HP-A0301R3 B1LF LF
DELTA	30W	Adapter DELTA 30W 19V 1.7x5.5x11 Black ADP-30JH BA LF
LITE-ON	30W	Adapter LITE-ON 30W 19V 1.7x5.5x11 Black PA-1300-04AC LF
HIPRO	30W	Adapter HIPRO 30W 19V 1.7x5.5x11 Black HP-A0301R3 B1LF LF
DELTA	30W	Adapter DELTA 30W 19V 1.7x5.5x11 Black ADP-30JH BA LF
LITE-ON	30W	Adapter LITE-ON 30W 19V 1.7x5.5x11 Black PA-1300-04AC LF
HIPRO	30W	Adapter HIPRO 30W 19V 1.7x5.5x11 Black HP-A0301R3 B1LF LF
DELTA	30W	Adapter DELTA 30W 19V 1.7x5.5x11 Black ADP-30JH BA LF
LITE-ON	30W	Adapter LITE-ON 30W 19V 1.7x5.5x11 Black PA-1300-04AC LF
HIPRO	30W	Adapter HIPRO 30W 19V 1.7x5.5x11 Black HP-A0301R3 B1LF LF
Audio Codec		
Realtek	ALC272X	Realtek Audio Codec ALC272X
Realtek	ALC272X	Realtek Audio Codec ALC272X
Realtek	ALC272X	Realtek Audio Codec ALC272X
Realtek	ALC272X	Realtek Audio Codec ALC272X
Realtek	ALC272X	Realtek Audio Codec ALC272X
Realtek	ALC272X	Realtek Audio Codec ALC272X
Realtek	ALC272X	Realtek Audio Codec ALC272X
Realtek	ALC272X	Realtek Audio Codec ALC272X

BRAND	Type	Description
Battery		
SANYO	3CELL2.2	Battery SANYO UM-2009A Li-Ion 3S1P SANYO 3 cell 2200mAh Main COMMON black w/Halogen Free
SANYO	3CELL2.2	Battery SANYO UM-2009AW Li-Ion 3S1P SANYO 3 cell 2200mAh Main COMMON white
SONY	3CELL2.2	Battery SONY UM-2009A Li-Ion 3S1P SONY 3 cell 2200mAh Main COMMON black
SONY	3CELL2.2	Battery SONY UM-2009AW Li-Ion 3S1P SONY 3 cell 2200mAh Main COMMON white
PANASONIC	3CELL2.2	Battery PANASONIC UM-2009A Li-Ion 3S1P PANASONIC 3 cell 2200mAh Main COMMON 2.2CG
PANASONIC	3CELL2.2	Battery PANASONIC UM-2009AW Li-Ion 3S1P PANASONIC 3 cell 2200mAh Main COMMON white
SIMPLO	3CELL2.2	Battery SIMPLO UM-2009A Li-Ion 3S1P PANASONIC 3 cell 2200mAh Main COMMON black, Panasonic 2.2CG
SIMPLO	3CELL2.2	Battery SIMPLO UM-2009A Li-Ion 3S1P SAMSUNG 3 cell 2200mAh Main COMMON black, SDI 2.2F
SIMPLO	3CELL2.2	Battery SIMPLO UM-2009A Li-Ion 3S1P LGC 3 cell 2200mAh Main COMMON black, LGC 2.2 S3
SIMPLO	3CELL2.2	Battery SIMPLO UM-2009AW Li-Ion 3S1P PANASONIC 3 cell 2200mAh Main COMMON white, Panasonic 2.2CG
SIMPLO	3CELL2.2	Battery SIMPLO UM-2009AW Li-Ion 3S1P SAMSUNG 3 cell 2200mAh Main COMMON white, SDI 2.2F
SIMPLO	3CELL2.2	Battery SIMPLO UM-2009AW Li-Ion 3S1P LGC 3 cell 2200mAh Main COMMON white, LG 2.2 S3
SANYO	6CELL2.6	Battery SANYO UM-2009B Li-Ion 3S2P SANYO 6 cell 5200mAh Main COMMON black w/Halogen Free
SANYO	6CELL2.2	Battery SANYO UM-2009B Li-Ion 3S2P SANYO 6 cell 4400mAh Main COMMON 2.2A w/Halogen Free
SANYO	3CELL2.2	Battery SANYO UM-2009A Li-Ion 3S1P SANYO 3 cell 2200mAh Main COMMON black w/Halogen Free
SANYO	3CELL2.2	Battery SANYO UM-2009AW Li-Ion 3S1P SANYO 3 cell 2200mAh Main COMMON white
SONY	3CELL2.2	Battery SONY UM-2009A Li-Ion 3S1P SONY 3 cell 2200mAh Main COMMON black
SONY	3CELL2.2	Battery SONY UM-2009AW Li-Ion 3S1P SONY 3 cell 2200mAh Main COMMON white
PANASONIC	3CELL2.2	Battery PANASONIC UM-2009A Li-Ion 3S1P PANASONIC 3 cell 2200mAh Main COMMON 2.2CG
PANASONIC	3CELL2.2	Battery PANASONIC UM-2009AW Li-Ion 3S1P PANASONIC 3 cell 2200mAh Main COMMON white
SIMPLO	3CELL2.2	Battery SIMPLO UM-2009A Li-Ion 3S1P PANASONIC 3 cell 2200mAh Main COMMON black, Panasonic 2.2CG
SIMPLO	3CELL2.2	Battery SIMPLO UM-2009A Li-Ion 3S1P SAMSUNG 3 cell 2200mAh Main COMMON black, SDI 2.2F
SIMPLO	3CELL2.2	Battery SIMPLO UM-2009A Li-Ion 3S1P LGC 3 cell 2200mAh Main COMMON black, LGC 2.2 S3
SIMPLO	3CELL2.2	Battery SIMPLO UM-2009AW Li-Ion 3S1P PANASONIC 3 cell 2200mAh Main COMMON white, Panasonic 2.2CG
SIMPLO	3CELL2.2	Battery SIMPLO UM-2009AW Li-Ion 3S1P SAMSUNG 3 cell 2200mAh Main COMMON white, SDI 2.2F
SIMPLO	3CELL2.2	Battery SIMPLO UM-2009AW Li-Ion 3S1P LGC 3 cell 2200mAh Main COMMON white, LG 2.2 S3

BRAND	Type	Description
SANYO	6CELL2.6	Battery SANYO UM-2009B Li-Ion 3S2P SANYO 6 cell 5200mAh Main COMMON black w/Halogen Free
SANYO	6CELL2.2	Battery SANYO UM-2009B Li-Ion 3S2P SANYO 6 cell 4400mAh Main COMMON 2.2A w/Halogen Free
SANYO	3CELL2.2	Battery SANYO UM-2009A Li-Ion 3S1P SANYO 3 cell 2200mAh Main COMMON black w/Halogen Free
SANYO	3CELL2.2	Battery SANYO UM-2009AW Li-Ion 3S1P SANYO 3 cell 2200mAh Main COMMON white
SONY	3CELL2.2	Battery SONY UM-2009A Li-Ion 3S1P SONY 3 cell 2200mAh Main COMMON black
SONY	3CELL2.2	Battery SONY UM-2009AW Li-Ion 3S1P SONY 3 cell 2200mAh Main COMMON white
PANASONIC	3CELL2.2	Battery PANASONIC UM-2009A Li-Ion 3S1P PANASONIC 3 cell 2200mAh Main COMMON 2.2CG
PANASONIC	3CELL2.2	Battery PANASONIC UM-2009AW Li-Ion 3S1P PANASONIC 3 cell 2200mAh Main COMMON white
SIMPLO	3CELL2.2	Battery SIMPLO UM-2009A Li-Ion 3S1P PANASONIC 3 cell 2200mAh Main COMMON black, Panasonic 2.2CG
SIMPLO	3CELL2.2	Battery SIMPLO UM-2009A Li-Ion 3S1P SAMSUNG 3 cell 2200mAh Main COMMON black, SDI 2.2F
SIMPLO	3CELL2.2	Battery SIMPLO UM-2009A Li-Ion 3S1P LGC 3 cell 2200mAh Main COMMON black, LGC 2.2 S3
SIMPLO	3CELL2.2	Battery SIMPLO UM-2009AW Li-Ion 3S1P PANASONIC 3 cell 2200mAh Main COMMON white, Panasonic 2.2CG
SIMPLO	3CELL2.2	Battery SIMPLO UM-2009AW Li-Ion 3S1P SAMSUNG 3 cell 2200mAh Main COMMON white, SDI 2.2F
SIMPLO	3CELL2.2	Battery SIMPLO UM-2009AW Li-Ion 3S1P LGC 3 cell 2200mAh Main COMMON white, LG 2.2 S3
SANYO	6CELL2.6	Battery SANYO UM-2009B Li-Ion 3S2P SANYO 6 cell 5200mAh Main COMMON black w/Halogen Free
SIMPLO	6CELL2.2	Battery SIMPLO UM-2009B Li-Ion 3S2P LGC 6 cell 4400mAh Main COMMON ID:UM09B73
SANYO	3CELL2.2	Battery SANYO UM-2009A Li-Ion 3S1P SANYO 3 cell 2200mAh Main COMMON black w/Halogen Free
SANYO	3CELL2.2	Battery SANYO UM-2009AW Li-Ion 3S1P SANYO 3 cell 2200mAh Main COMMON white
SONY	3CELL2.2	Battery SONY UM-2009A Li-Ion 3S1P SONY 3 cell 2200mAh Main COMMON black
SONY	3CELL2.2	Battery SONY UM-2009AW Li-Ion 3S1P SONY 3 cell 2200mAh Main COMMON white
PANASONIC	3CELL2.2	Battery PANASONIC UM-2009A Li-Ion 3S1P PANASONIC 3 cell 2200mAh Main COMMON 2.2CG
PANASONIC	3CELL2.2	Battery PANASONIC UM-2009AW Li-Ion 3S1P PANASONIC 3 cell 2200mAh Main COMMON white
SIMPLO	3CELL2.2	Battery SIMPLO UM-2009A Li-Ion 3S1P PANASONIC 3 cell 2200mAh Main COMMON black, Panasonic 2.2CG
SIMPLO	3CELL2.2	Battery SIMPLO UM-2009A Li-Ion 3S1P SAMSUNG 3 cell 2200mAh Main COMMON black, SDI 2.2F
SIMPLO	3CELL2.2	Battery SIMPLO UM-2009A Li-Ion 3S1P LGC 3 cell 2200mAh Main COMMON black, LGC 2.2 S3
SIMPLO	3CELL2.2	Battery SIMPLO UM-2009AW Li-Ion 3S1P PANASONIC 3 cell 2200mAh Main COMMON white, Panasonic 2.2CG
SIMPLO	3CELL2.2	Battery SIMPLO UM-2009AW Li-Ion 3S1P SAMSUNG 3 cell 2200mAh Main COMMON white, SDI 2.2F

BRAND	Type	Description
SIMPLO	3CELL2.2	Battery SIMPLO UM-2009AW Li-Ion 3S1P LGC 3 cell 2200mAh Main COMMON white, LG 2.2 S3
SANYO	6CELL2.6	Battery SANYO UM-2009B Li-Ion 3S2P SANYO 6 cell 5200mAh Main COMMON black w/Halogen Free
SANYO	6CELL2.2	Battery SANYO UM-2009B Li-Ion 3S2P SANYO 6 cell 4400mAh Main COMMON 2.2A w/Halogen Free
SANYO	3CELL2.2	Battery SANYO UM-2009A Li-Ion 3S1P SANYO 3 cell 2200mAh Main COMMON black w/Halogen Free
SANYO	3CELL2.2	Battery SANYO UM-2009AW Li-Ion 3S1P SANYO 3 cell 2200mAh Main COMMON white
SONY	3CELL2.2	Battery SONY UM-2009A Li-Ion 3S1P SONY 3 cell 2200mAh Main COMMON black
SONY	3CELL2.2	Battery SONY UM-2009AW Li-Ion 3S1P SONY 3 cell 2200mAh Main COMMON white
PANASONIC	3CELL2.2	Battery PANASONIC UM-2009A Li-Ion 3S1P PANASONIC 3 cell 2200mAh Main COMMON 2.2CG
PANASONIC	3CELL2.2	Battery PANASONIC UM-2009AW Li-Ion 3S1P PANASONIC 3 cell 2200mAh Main COMMON white
SIMPLO	3CELL2.2	Battery SIMPLO UM-2009A Li-Ion 3S1P PANASONIC 3 cell 2200mAh Main COMMON black, Panasonic 2.2CG
SIMPLO	3CELL2.2	Battery SIMPLO UM-2009A Li-Ion 3S1P SAMSUNG 3 cell 2200mAh Main COMMON black, SDI 2.2F
SIMPLO	3CELL2.2	Battery SIMPLO UM-2009A Li-Ion 3S1P LGC 3 cell 2200mAh Main COMMON black, LG 2.2 S3
SIMPLO	3CELL2.2	Battery SIMPLO UM-2009AW Li-Ion 3S1P PANASONIC 3 cell 2200mAh Main COMMON white, Panasonic 2.2CG
SIMPLO	3CELL2.2	Battery SIMPLO UM-2009AW Li-Ion 3S1P SAMSUNG 3 cell 2200mAh Main COMMON white, SDI 2.2F
SIMPLO	3CELL2.2	Battery SIMPLO UM-2009AW Li-Ion 3S1P LGC 3 cell 2200mAh Main COMMON white, LG 2.2 S3
SANYO	6CELL2.6	Battery SANYO UM-2009B Li-Ion 3S2P SANYO 6 cell 5200mAh Main COMMON black w/Halogen Free
SANYO	6CELL2.2	Battery SANYO UM-2009B Li-Ion 3S2P SANYO 6 cell 4400mAh Main COMMON 2.2A w/Halogen Free
SANYO	3CELL2.2	Battery SANYO UM-2009A Li-Ion 3S1P SANYO 3 cell 2200mAh Main COMMON black w/Halogen Free
SANYO	3CELL2.2	Battery SANYO UM-2009AW Li-Ion 3S1P SANYO 3 cell 2200mAh Main COMMON white
SONY	3CELL2.2	Battery SONY UM-2009A Li-Ion 3S1P SONY 3 cell 2200mAh Main COMMON black
SONY	3CELL2.2	Battery SONY UM-2009AW Li-Ion 3S1P SONY 3 cell 2200mAh Main COMMON white
PANASONIC	3CELL2.2	Battery PANASONIC UM-2009A Li-Ion 3S1P PANASONIC 3 cell 2200mAh Main COMMON 2.2CG
PANASONIC	3CELL2.2	Battery PANASONIC UM-2009AW Li-Ion 3S1P PANASONIC 3 cell 2200mAh Main COMMON white
SIMPLO	3CELL2.2	Battery SIMPLO UM-2009A Li-Ion 3S1P PANASONIC 3 cell 2200mAh Main COMMON black, Panasonic 2.2CG
SIMPLO	3CELL2.2	Battery SIMPLO UM-2009A Li-Ion 3S1P SAMSUNG 3 cell 2200mAh Main COMMON black, SDI 2.2F
SIMPLO	3CELL2.2	Battery SIMPLO UM-2009A Li-Ion 3S1P LGC 3 cell 2200mAh Main COMMON black, LG 2.2 S3
SIMPLO	3CELL2.2	Battery SIMPLO UM-2009AW Li-Ion 3S1P PANASONIC 3 cell 2200mAh Main COMMON white, Panasonic 2.2CG

BRAND	Type	Description
SIMPLO	3CELL2.2	Battery SIMPLO UM-2009AW Li-Ion 3S1P SAMSUNG 3 cell 2200mAh Main COMMON white, SDI 2.2F
SIMPLO	3CELL2.2	Battery SIMPLO UM-2009AW Li-Ion 3S1P LGC 3 cell 2200mAh Main COMMON white, LG 2.2 S3
SANYO	6CELL2.6	Battery SANYO UM-2009B Li-Ion 3S2P SANYO 6 cell 5200mAh Main COMMON black w/Halogen Free
SIMPLO	6CELL2.2	Battery SIMPLO UM-2009B Li-Ion 3S2P LGC 6 cell 4400mAh Main COMMON ID:UM09B73
SANYO	3CELL2.2	Battery SANYO UM-2009A Li-Ion 3S1P SANYO 3 cell 2200mAh Main COMMON black w/Halogen Free
SANYO	3CELL2.2	Battery SANYO UM-2009AW Li-Ion 3S1P SANYO 3 cell 2200mAh Main COMMON white
SONY	3CELL2.2	Battery SONY UM-2009A Li-Ion 3S1P SONY 3 cell 2200mAh Main COMMON black
SONY	3CELL2.2	Battery SONY UM-2009AW Li-Ion 3S1P SONY 3 cell 2200mAh Main COMMON white
PANASONIC	3CELL2.2	Battery PANASONIC UM-2009A Li-Ion 3S1P PANASONIC 3 cell 2200mAh Main COMMON 2.2CG
PANASONIC	3CELL2.2	Battery PANASONIC UM-2009AW Li-Ion 3S1P PANASONIC 3 cell 2200mAh Main COMMON white
SIMPLO	3CELL2.2	Battery SIMPLO UM-2009A Li-Ion 3S1P PANASONIC 3 cell 2200mAh Main COMMON black, Panasonic 2.2CG
SIMPLO	3CELL2.2	Battery SIMPLO UM-2009A Li-Ion 3S1P SAMSUNG 3 cell 2200mAh Main COMMON black, SDI 2.2F
SIMPLO	3CELL2.2	Battery SIMPLO UM-2009A Li-Ion 3S1P LGC 3 cell 2200mAh Main COMMON black, LG 2.2 S3
SIMPLO	3CELL2.2	Battery SIMPLO UM-2009AW Li-Ion 3S1P PANASONIC 3 cell 2200mAh Main COMMON white, Panasonic 2.2CG
SIMPLO	3CELL2.2	Battery SIMPLO UM-2009AW Li-Ion 3S1P SAMSUNG 3 cell 2200mAh Main COMMON white, SDI 2.2F
SIMPLO	3CELL2.2	Battery SIMPLO UM-2009AW Li-Ion 3S1P LGC 3 cell 2200mAh Main COMMON white, LG 2.2 S3
SANYO	6CELL2.6	Battery SANYO UM-2009B Li-Ion 3S2P SANYO 6 cell 5200mAh Main COMMON black w/Halogen Free
PANASONIC	6CELL2.2	Battery PANASONIC UM-2009B Li-Ion 3S2P PANASONIC 6 cell 4400mAh Main COMMON ID:UM09B51
SANYO	3CELL2.2	Battery SANYO UM-2009A Li-Ion 3S1P SANYO 3 cell 2200mAh Main COMMON black w/Halogen Free
SANYO	3CELL2.2	Battery SANYO UM-2009AW Li-Ion 3S1P SANYO 3 cell 2200mAh Main COMMON white
SONY	3CELL2.2	Battery SONY UM-2009A Li-Ion 3S1P SONY 3 cell 2200mAh Main COMMON black
SONY	3CELL2.2	Battery SONY UM-2009AW Li-Ion 3S1P SONY 3 cell 2200mAh Main COMMON white
PANASONIC	3CELL2.2	Battery PANASONIC UM-2009A Li-Ion 3S1P PANASONIC 3 cell 2200mAh Main COMMON 2.2CG
PANASONIC	3CELL2.2	Battery PANASONIC UM-2009AW Li-Ion 3S1P PANASONIC 3 cell 2200mAh Main COMMON white
SIMPLO	3CELL2.2	Battery SIMPLO UM-2009A Li-Ion 3S1P PANASONIC 3 cell 2200mAh Main COMMON black, Panasonic 2.2CG
SIMPLO	3CELL2.2	Battery SIMPLO UM-2009A Li-Ion 3S1P SAMSUNG 3 cell 2200mAh Main COMMON black, SDI 2.2F
SIMPLO	3CELL2.2	Battery SIMPLO UM-2009A Li-Ion 3S1P LGC 3 cell 2200mAh Main COMMON black, LG 2.2 S3

BRAND	Type	Description
SIMPLO	3CELL2.2	Battery SIMPLO UM-2009AW Li-Ion 3S1P PANASONIC 3 cell 2200mAh Main COMMON white, Panasonic 2.2CG
SIMPLO	3CELL2.2	Battery SIMPLO UM-2009AW Li-Ion 3S1P SAMSUNG 3 cell 2200mAh Main COMMON white, SDI 2.2F
SIMPLO	3CELL2.2	Battery SIMPLO UM-2009AW Li-Ion 3S1P LGC 3 cell 2200mAh Main COMMON white, LG 2.2 S3
SANYO	6CELL2.6	Battery SANYO UM-2009B Li-Ion 3S2P SANYO 6 cell 5200mAh Main COMMON black w/Halogen Free
SANYO	6CELL2.2	Battery SANYO UM-2009B Li-Ion 3S2P SANYO 6 cell 4400mAh Main COMMON UM09B31
Bluetooth		
Foxconn	BT 2.0	Foxconn Bluetooth FOX_BRM_2.0 F/W 300
Foxconn	BT 2.0	Foxconn Bluetooth FOX_BRM_2.0 F/W 300
Foxconn	BT 2.0	Foxconn Bluetooth FOX_BRM_2.0 F/W 300
Foxconn	BT 2.0	Foxconn Bluetooth FOX_BRM_2.0 F/W 300
Foxconn	BT 2.0	Foxconn Bluetooth FOX_BRM_2.0 F/W 300
Foxconn	BT 2.0	Foxconn Bluetooth FOX_BRM_2.0 F/W 300
Foxconn	BT 2.0	Foxconn Bluetooth FOX_BRM_2.0 F/W 300
Foxconn	BT 2.0	Foxconn Bluetooth FOX_BRM_2.0 F/W 300
Camera		
Suyin	0.3M LDV	Suyin Camera Rose_2G
Chicony	0.3M LDV	Chicony Camera Lilac_2G
Suyin	0.3M LDV	Suyin Camera Rose_2G
Chicony	0.3M LDV	Chicony Camera Lilac_2G
Suyin	0.3M LDV	Suyin Camera Rose_2G
Chicony	0.3M LDV	Chicony Camera Lilac_2G
Suyin	0.3M LDV	Suyin Camera Rose_2G
Chicony	0.3M LDV	Chicony Camera Lilac_2G
Suyin	0.3M LDV	Suyin Camera Rose_2G
Chicony	0.3M LDV	Chicony Camera Lilac_2G
Suyin	0.3M LDV	Suyin Camera Rose_2G
Chicony	0.3M LDV	Chicony Camera Lilac_2G
Suyin	0.3M LDV	Suyin Camera Rose_2G
Chicony	0.3M LDV	Chicony Camera Lilac_2G
Suyin	0.3M LDV	Suyin Camera Rose_2G
Chicony	0.3M LDV	Chicony Camera Lilac_2G
Card Reader		
N/A	5 in 1-Build in	5 in 1-Build in MS, MS Pro, SD, SC, XD
N/A	5 in 1-Build in	5 in 1-Build in MS, MS Pro, SD, SC, XD
N/A	5 in 1-Build in	5 in 1-Build in MS, MS Pro, SD, SC, XD
N/A	5 in 1-Build in	5 in 1-Build in MS, MS Pro, SD, SC, XD
N/A	5 in 1-Build in	5 in 1-Build in MS, MS Pro, SD, SC, XD
N/A	5 in 1-Build in	5 in 1-Build in MS, MS Pro, SD, SC, XD
N/A	5 in 1-Build in	5 in 1-Build in MS, MS Pro, SD, SC, XD
N/A	5 in 1-Build in	5 in 1-Build in MS, MS Pro, SD, SC, XD
CPU/Processor		
INTEL	ATMZ520B	CPU Intel Atom Z520 BGA 1.33G 512K 533 C-0

BRAND	Type	Description
INTEL	ATMZ520B	CPU Intel Atom Z520 BGA 1.33G 512K 533 C-0
INTEL	ATMZ520B	CPU Intel Atom Z520 BGA 1.33G 512K 533 C-0
INTEL	ATMZ520B	CPU Intel Atom Z520 BGA 1.33G 512K 533 C-0
INTEL	ATMZ520B	CPU Intel Atom Z520 BGA 1.33G 512K 533 C-0
INTEL	ATMZ530B	CPU Intel Atom Z520 1.6G 512K 533 C-0
INTEL	ATMZ520B	CPU Intel Atom Z520 BGA 1.33G 512K 533 C-0
INTEL	ATMZ520B	CPU Intel Atom Z520 BGA 1.33G 512K 533 C-0
INTEL	ATMZ520B	CPU Intel Atom Z520 BGA 1.33G 512K 533 C-0
HDD		
SEAGATE	N160GB5.4KS	HDD SEAGATE 2.5" 5400rpm 160GB ST9160310AS Crockett SATA LF F/W:0303
TOSHIBA	N160GB5.4KS	HDD TOSHIBA 2.5" 5400rpm 160GB MK1655GSX Libra SATA LF F/W:FG011J
HGST	N160GB5.4KS	HDD HGST 2.5" 5400rpm 160GB HTS543216L9A300 Falcon-B SATA LF F/W:C40C
HGST	N160GB5.4KS	HDD HGST 2.5" 5400rpm 160GB HTS545016B9A300 Panther B SATA LF F/W:C60F
WD	N160GB5.4KS	HDD WD 2.5" 5400rpm 160GB WD1600BEVT-22ZCTO ML160 SATA LF F/W:11.01A11
SEAGATE	N250GB5.4KS	HDD SEAGATE 2.5" 5400rpm 250GB ST9250315AS Wyatt SATA LF F/W:0001SDM1
SEAGATE	N160GB5.4KS	HDD SEAGATE 2.5" 5400rpm 160GB ST9160310AS Crockett SATA LF F/W:0303
TOSHIBA	N160GB5.4KS	HDD TOSHIBA 2.5" 5400rpm 160GB MK1655GSX Libra SATA LF F/W:FG011J
HGST	N160GB5.4KS	HDD HGST 2.5" 5400rpm 160GB HTS543216L9A300 Falcon-B SATA LF F/W:C40C
HGST	N160GB5.4KS	HDD HGST 2.5" 5400rpm 160GB HTS545016B9A300 Panther B SATA LF F/W:C60F
WD	N160GB5.4KS	HDD WD 2.5" 5400rpm 160GB WD1600BEVT-22ZCTO ML160 SATA LF F/W:11.01A11
SEAGATE	N250GB5.4KS	HDD SEAGATE 2.5" 5400rpm 250GB ST9250315AS Wyatt SATA LF F/W:0001SDM1
SEAGATE	N160GB5.4KS	HDD SEAGATE 2.5" 5400rpm 160GB ST9160310AS Crockett SATA LF F/W:0303
TOSHIBA	N160GB5.4KS	HDD TOSHIBA 2.5" 5400rpm 160GB MK1655GSX Libra SATA LF F/W:FG011J
HGST	N160GB5.4KS	HDD HGST 2.5" 5400rpm 160GB HTS543216L9A300 Falcon-B SATA LF F/W:C40C
HGST	N160GB5.4KS	HDD HGST 2.5" 5400rpm 160GB HTS545016B9A300 Panther B SATA LF F/W:C60F
WD	N160GB5.4KS	HDD WD 2.5" 5400rpm 160GB WD1600BEVT-22ZCTO ML160 SATA LF F/W:11.01A11
SEAGATE	N250GB5.4KS	HDD SEAGATE 2.5" 5400rpm 250GB ST9250315AS Wyatt SATA LF F/W:0001SDM1
SEAGATE	N160GB5.4KS	HDD SEAGATE 2.5" 5400rpm 160GB ST9160310AS Crockett SATA LF F/W:0303
TOSHIBA	N160GB5.4KS	HDD TOSHIBA 2.5" 5400rpm 160GB MK1655GSX Libra SATA LF F/W:FG011J
HGST	N160GB5.4KS	HDD HGST 2.5" 5400rpm 160GB HTS543216L9A300 Falcon-B SATA LF F/W:C40C

BRAND	Type	Description
HGST	N160GB5.4KS	HDD HGST 2.5" 5400rpm 160GB HTS545016B9A300 Panther B SATA LF F/W:C60F
WD	N160GB5.4KS	HDD WD 2.5" 5400rpm 160GB WD1600BEVT-22ZCTO ML160 SATA LF F/W:11.01A11
SEAGATE	N250GB5.4KS	HDD SEAGATE 2.5" 5400rpm 250GB ST9250315AS Wyatt SATA LF F/W:0001SDM1
SEAGATE	N160GB5.4KS	HDD SEAGATE 2.5" 5400rpm 160GB ST9160310AS Crockett SATA LF F/W:0303
TOSHIBA	N160GB5.4KS	HDD TOSHIBA 2.5" 5400rpm 160GB MK1655GSX Libra SATA LF F/W:FG011J
HGST	N160GB5.4KS	HDD HGST 2.5" 5400rpm 160GB HTS543216L9A300 Falcon-B SATA LF F/W:C40C
HGST	N160GB5.4KS	HDD HGST 2.5" 5400rpm 160GB HTS545016B9A300 Panther B SATA LF F/W:C60F
WD	N160GB5.4KS	HDD WD 2.5" 5400rpm 160GB WD1600BEVT-22ZCTO ML160 SATA LF F/W:11.01A11
SEAGATE	N250GB5.4KS	HDD SEAGATE 2.5" 5400rpm 250GB ST9250315AS Wyatt SATA LF F/W:0001SDM1
SEAGATE	N160GB5.4KS	HDD SEAGATE 2.5" 5400rpm 160GB ST9160310AS Crockett SATA LF F/W:0303
TOSHIBA	N160GB5.4KS	HDD TOSHIBA 2.5" 5400rpm 160GB MK1655GSX Libra SATA LF F/W:FG011J
HGST	N160GB5.4KS	HDD HGST 2.5" 5400rpm 160GB HTS543216L9A300 Falcon-B SATA LF F/W:C40C
HGST	N160GB5.4KS	HDD HGST 2.5" 5400rpm 160GB HTS545016B9A300 Panther B SATA LF F/W:C60F
WD	N160GB5.4KS	HDD WD 2.5" 5400rpm 160GB WD1600BEVT-22ZCTO ML160 SATA LF F/W:11.01A11
SEAGATE	N250GB5.4KS	HDD SEAGATE 2.5" 5400rpm 250GB ST9250315AS Wyatt SATA LF F/W:0001SDM1
SEAGATE	N160GB5.4KS	HDD SEAGATE 2.5" 5400rpm 160GB ST9160310AS Crockett SATA LF F/W:0303
TOSHIBA	N160GB5.4KS	HDD TOSHIBA 2.5" 5400rpm 160GB MK1655GSX Libra SATA LF F/W:FG011J
HGST	N160GB5.4KS	HDD HGST 2.5" 5400rpm 160GB HTS543216L9A300 Falcon-B SATA LF F/W:C40C
HGST	N160GB5.4KS	HDD HGST 2.5" 5400rpm 160GB HTS545016B9A300 Panther B SATA LF F/W:C60F
WD	N160GB5.4KS	HDD WD 2.5" 5400rpm 160GB WD1600BEVT-22ZCTO ML160 SATA LF F/W:11.01A11
SEAGATE	N250GB5.4KS	HDD SEAGATE 2.5" 5400rpm 250GB ST9250315AS Wyatt SATA LF F/W:0001SDM1
SEAGATE	N160GB5.4KS	HDD SEAGATE 2.5" 5400rpm 160GB ST9160310AS Crockett SATA LF F/W:0303
TOSHIBA	N160GB5.4KS	HDD TOSHIBA 2.5" 5400rpm 160GB MK1655GSX Libra SATA LF F/W:FG011J
HGST	N160GB5.4KS	HDD HGST 2.5" 5400rpm 160GB HTS543216L9A300 Falcon-B SATA LF F/W:C40C
HGST	N160GB5.4KS	HDD HGST 2.5" 5400rpm 160GB HTS545016B9A300 Panther B SATA LF F/W:C60F
WD	N160GB5.4KS	HDD WD 2.5" 5400rpm 160GB WD1600BEVT-22ZCTO ML160 SATA LF F/W:11.01A11
SEAGATE	N250GB5.4KS	HDD SEAGATE 2.5" 5400rpm 250GB ST9250315AS Wyatt SATA LF F/W:0001SDM1

BRAND	Type	Description
Keyboard		
ACER	NT1T	Keyboard ACER NT-1T JV11 Internal 11 Standard Black NONE Texture
ACER	NT1T	Keyboard ACER NT-1T JV11 Internal 11 Standard Black NONE Texture
ACER	NT1T	Keyboard ACER NT-1T JV11 Internal 11 Standard Black NONE Texture
ACER	NT1T	Keyboard ACER NT-1T JV11 Internal 11 Standard Black NONE Texture
ACER	NT1T	Keyboard ACER NT-1T JV11 Internal 11 Standard Black NONE Texture
ACER	NT1T	Keyboard ACER NT-1T JV11 Internal 11 Standard Black NONE Texture
ACER	NT1T	Keyboard ACER NT-1T JV11 Internal 11 Standard Black NONE Texture
ACER	NT1T	Keyboard ACER NT-1T JV11 Internal 11 Standard Black NONE Texture
LAN		
Realtek	RTL8103EA	Realtek RTL8103EA
Realtek	RTL8103EA	Realtek RTL8103EA
Realtek	RTL8103EA	Realtek RTL8103EA
Realtek	RTL8103EA	Realtek RTL8103EA
Realtek	RTL8103EA	Realtek RTL8103EA
Realtek	RTL8103EA	Realtek RTL8103EA
Realtek	RTL8103EA	Realtek RTL8103EA
Realtek	RTL8103EA	Realtek RTL8103EA
LCD		
AUO	NLED11.6WXGAG	LED LCD AUO 11.6" WXGA Glare B116XW02 V0 LF 200nit 8ms 500:1
SAMSUNG	NLED11.6WXGAG	LED LCD SAMSUNG 11.6" WXGA Glare LTN116AT01-A01 LF 200nit 8ms
LPL	NLED11.6WXGAG	LED LCD LPL 11.6" WXGA Glare LP116WH1-TLA1 LF 200nit 8ms 500:1
CMO	NLED11.6WXGAG	LED LCD CMO 11.6" WXGA Glare N116B6-L02 LF 200nit 10ms 500:1
AUO	NLED11.6WXGAG	LED LCD AUO 11.6" WXGA Glare B116XW02 V0 LF 200nit 8ms 500:1
SAMSUNG	NLED11.6WXGAG	LED LCD SAMSUNG 11.6" WXGA Glare LTN116AT01-A01 LF 200nit 8ms
LPL	NLED11.6WXGAG	LED LCD LPL 11.6" WXGA Glare LP116WH1-TLA1 LF 200nit 8ms 500:1
CMO	NLED11.6WXGAG	LED LCD CMO 11.6" WXGA Glare N116B6-L02 LF 200nit 10ms 500:1
AUO	NLED11.6WXGAG	LED LCD AUO 11.6" WXGA Glare B116XW02 V0 LF 200nit 8ms 500:1
SAMSUNG	NLED11.6WXGAG	LED LCD SAMSUNG 11.6" WXGA Glare LTN116AT01-A01 LF 200nit 8ms
LPL	NLED11.6WXGAG	LED LCD LPL 11.6" WXGA Glare LP116WH1-TLA1 LF 200nit 8ms 500:1
CMO	NLED11.6WXGAG	LED LCD CMO 11.6" WXGA Glare N116B6-L02 LF 200nit 10ms 500:1
AUO	NLED11.6WXGAG	LED LCD AUO 11.6" WXGA Glare B116XW02 V0 LF 200nit 8ms 500:1
SAMSUNG	NLED11.6WXGAG	LED LCD SAMSUNG 11.6" WXGA Glare LTN116AT01-A01 LF 200nit 8ms
LPL	NLED11.6WXGAG	LED LCD LPL 11.6" WXGA Glare LP116WH1-TLA1 LF 200nit 8ms 500:1
CMO	NLED11.6WXGAG	LED LCD CMO 11.6" WXGA Glare N116B6-L02 LF 200nit 10ms 500:1
AUO	NLED11.6WXGAG	LED LCD AUO 11.6" WXGA Glare B116XW02 V0 LF 200nit 8ms 500:1
SAMSUNG	NLED11.6WXGAG	LED LCD SAMSUNG 11.6" WXGA Glare LTN116AT01-A01 LF 200nit 8ms
LPL	NLED11.6WXGAG	LED LCD LPL 11.6" WXGA Glare LP116WH1-TLA1 LF 200nit 8ms 500:1
CMO	NLED11.6WXGAG	LED LCD CMO 11.6" WXGA Glare N116B6-L02 LF 200nit 10ms 500:1
AUO	NLED11.6WXGAG	LED LCD AUO 11.6" WXGA Glare B116XW02 V0 LF 200nit 8ms 500:1
SAMSUNG	NLED11.6WXGAG	LED LCD SAMSUNG 11.6" WXGA Glare LTN116AT01-A01 LF 200nit 8ms
LPL	NLED11.6WXGAG	LED LCD LPL 11.6" WXGA Glare LP116WH1-TLA1 LF 200nit 8ms 500:1

BRAND	Type	Description
CMO	NLED11.6WXGAG	LED LCD CMO 11.6" WXGA Glare N116B6-L02 LF 200nit 10ms 500:1
AUO	NLED11.6WXGAG	LED LCD AUO 11.6" WXGA Glare B116XW02 V0 LF 200nit 8ms 500:1
SAMSUNG	NLED11.6WXGAG	LED LCD SAMSUNG 11.6" WXGA Glare LTN116AT01-A01 LF 200nit 8ms
LPL	NLED11.6WXGAG	LED LCD LPL 11.6" WXGA Glare LP116WH1-TLA1 LF 200nit 8ms 500:1
CMO	NLED11.6WXGAG	LED LCD CMO 11.6" WXGA Glare N116B6-L02 LF 200nit 10ms 500:1
Memory		
NANYA	SO1GBII6	Memory NANYA SO-DIMM DDRII 667 1GB NT1GT64UH8D0FN-3C LF 64*16 0.07um
ELPIDA	SO1GBII6	Memory ELPIDA SO-DIMM DDRII 667 1GB EBE11UE6AESA-6E-F LF 64*16 0.065um
SAMSUNG	SO1GBII6	Memory SAMSUNG SO-DIMM DDRII 667 1GB M470T2864QZ3-CE6 LF
HYNIX	SO1GBII6	Memory HYNIX SO-DIMM DDRII 667 1GB HYMP112S64CP6-Y5 LF
SAMSUNG	SO2GBII6	Memory SAMSUNG SO-DIMM DDRII 667 2GB M470T5663EH3-CE6 LF 128*8 0.055um
HYNIX	SO2GBII6	Memory HYNIX SO-DIMM DDRII 667 2GB HYMP125S64CP8-Y5 LF
NANYA	SO1GBII6	Memory NANYA SO-DIMM DDRII 667 1GB NT1GT64UH8D0FN-3C LF 64*16 0.07um
ELPIDA	SO1GBII6	Memory ELPIDA SO-DIMM DDRII 667 1GB EBE11UE6AESA-6E-F LF 64*16 0.065um
SAMSUNG	SO1GBII6	Memory SAMSUNG SO-DIMM DDRII 667 1GB M470T2864QZ3-CE6 LF
HYNIX	SO1GBII6	Memory HYNIX SO-DIMM DDRII 667 1GB HYMP112S64CP6-Y5 LF
SAMSUNG	SO2GBII6	Memory SAMSUNG SO-DIMM DDRII 667 2GB M470T5663EH3-CE6 LF 128*8 0.055um
NANYA	SO1GBII6	Memory NANYA SO-DIMM DDRII 667 1GB NT1GT64UH8D0FN-3C LF 64*16 0.07um
ELPIDA	SO1GBII6	Memory ELPIDA SO-DIMM DDRII 667 1GB EBE11UE6AESA-6E-F LF 64*16 0.065um
SAMSUNG	SO1GBII6	Memory SAMSUNG SO-DIMM DDRII 667 1GB M470T2864QZ3-CE6 LF
HYNIX	SO1GBII6	Memory HYNIX SO-DIMM DDRII 667 1GB HYMP112S64CP6-Y5 LF
SAMSUNG	SO2GBII6	Memory SAMSUNG SO-DIMM DDRII 667 2GB M470T5663EH3-CE6 LF 128*8 0.055um
NANYA	SO1GBII6	Memory NANYA SO-DIMM DDRII 667 1GB NT1GT64UH8D0FN-3C LF 64*16 0.07um
ELPIDA	SO1GBII6	Memory ELPIDA SO-DIMM DDRII 667 1GB EBE11UE6AESA-6E-F LF 64*16 0.065um
SAMSUNG	SO1GBII6	Memory SAMSUNG SO-DIMM DDRII 667 1GB M470T2864QZ3-CE6 LF
HYNIX	SO1GBII6	Memory HYNIX SO-DIMM DDRII 667 1GB HYMP112S64CP6-Y5 LF
SAMSUNG	SO2GBII6	Memory SAMSUNG SO-DIMM DDRII 667 2GB M470T5663EH3-CE6 LF 128*8 0.055um
NANYA	SO1GBII6	Memory NANYA SO-DIMM DDRII 667 1GB NT1GT64UH8D0FN-3C LF 64*16 0.07um
ELPIDA	SO1GBII6	Memory ELPIDA SO-DIMM DDRII 667 1GB EBE11UE6AESA-6E-F LF 64*16 0.065um
SAMSUNG	SO1GBII6	Memory SAMSUNG SO-DIMM DDRII 667 1GB M470T2864QZ3-CE6 LF
HYNIX	SO1GBII6	Memory HYNIX SO-DIMM DDRII 667 1GB HYMP112S64CP6-Y5 LF
SAMSUNG	SO2GBII6	Memory SAMSUNG SO-DIMM DDRII 667 2GB M470T5663EH3-CE6 LF 128*8 0.055um
SAMSUNG	SO512MBII6	Memory SAMSUNG SO-DIMM DDRII 667 512MB M470T6464QZ3-CE6 LF
HYNIX	SO512MBII6	Memory HYNIX SO-DIMM DDRII 667 512MB HYMP164S64CP6-Y5 LF 64*16 0.065um

BRAND	Type	Description
NANYA	SO1GBII6	Memory NANYA SO-DIMM DDRII 667 1GB NT1GT64UH8D0FN-3C LF 64*16 0.07um
ELPIDA	SO1GBII6	Memory ELPIDA SO-DIMM DDRII 667 1GB EBE11UE6AESA-6E-F LF 64*16 0.065um
SAMSUNG	SO1GBII6	Memory SAMSUNG SO-DIMM DDRII 667 1GB M470T2864QZ3-CE6 LF
HYNIX	SO1GBII6	Memory HYNIX SO-DIMM DDRII 667 1GB HYMP112S64CP6-Y5 LF
SAMSUNG	SO2GBII6	Memory SAMSUNG SO-DIMM DDRII 667 2GB M470T5663EH3-CE6 LF 128*8 0.055um
NANYA	SO1GBII6	Memory NANYA SO-DIMM DDRII 667 1GB NT1GT64UH8D0FN-3C LF 64*16 0.07um
ELPIDA	SO1GBII6	Memory ELPIDA SO-DIMM DDRII 667 1GB EBE11UE6AESA-6E-F LF 64*16 0.065um
SAMSUNG	SO1GBII6	Memory SAMSUNG SO-DIMM DDRII 667 1GB M470T2864QZ3-CE6 LF
HYNIX	SO1GBII6	Memory HYNIX SO-DIMM DDRII 667 1GB HYMP112S64CP6-Y5 LF
SAMSUNG	SO2GBII6	Memory SAMSUNG SO-DIMM DDRII 667 2GB M470T5663EH3-CE6 LF 128*8 0.055um
NANYA	SO1GBII6	Memory NANYA SO-DIMM DDRII 667 1GB NT1GT64UH8D0FN-3C LF 64*16 0.07um
ELPIDA	SO1GBII6	Memory ELPIDA SO-DIMM DDRII 667 1GB EBE11UE6AESA-6E-F LF 64*16 0.065um
SAMSUNG	SO1GBII6	Memory SAMSUNG SO-DIMM DDRII 667 1GB M470T2864QZ3-CE6 LF
HYNIX	SO1GBII6	Memory HYNIX SO-DIMM DDRII 667 1GB HYMP112S64CP6-Y5 LF
SAMSUNG	SO2GBII6	Memory SAMSUNG SO-DIMM DDRII 667 2GB M470T5663EH3-CE6 LF 128*8 0.055um
Modem		
N/A	External USB Lite+LSI modem	External USB Lite+LSI modem
N/A	External USB Lite+LSI modem	External USB Lite+LSI modem
N/A	External USB Lite+LSI modem	External USB Lite+LSI modem
N/A	External USB Lite+LSI modem	External USB Lite+LSI modem
N/A	External USB Lite+LSI modem	External USB Lite+LSI modem
N/A	External USB Lite+LSI modem	External USB Lite+LSI modem
N/A	External USB Lite+LSI modem	External USB Lite+LSI modem
N/A	External USB Lite+LSI modem	External USB Lite+LSI modem
Northbridge Chipset		
INTEL	US15W	NB Chipset Intel CS AF82US15W D-2 MM#899760
INTEL	US15W	NB Chipset Intel CS AF82US15W D-2 MM#899760
INTEL	US15W	NB Chipset Intel CS AF82US15W D-2 MM#899760
INTEL	US15W	NB Chipset Intel CS AF82US15W D-2 MM#899760
INTEL	US15W	NB Chipset Intel CS AF82US15W D-2 MM#899760
INTEL	US15W	NB Chipset Intel CS AF82US15W D-2 MM#899760
INTEL	US15W	NB Chipset Intel CS AF82US15W D-2 MM#899760
INTEL	US15W	NB Chipset Intel CS AF82US15W D-2 MM#899760

BRAND	Type	Description
Software		
N/A	McAfee	Antivirus application McAfee
N/A	McAfee	Antivirus application McAfee
N/A	McAfee	Antivirus application McAfee
N/A	McAfee	Antivirus application McAfee
N/A	McAfee	Antivirus application McAfee
N/A	McAfee	Antivirus application McAfee
N/A	McAfee	Antivirus application McAfee
N/A	McAfee	Antivirus application McAfee
VGA Chip		
None	UMA	UMA (Intel)
None	UMA	UMA (Intel)
None	UMA	UMA (Intel)
None	UMA	UMA (Intel)
None	UMA	UMA (Intel)
None	UMA	UMA (Intel)
None	UMA	UMA (Intel)
None	UMA	UMA (Intel)
WiFi Antenna		
WNC	PIFA	PIFA
WNC	PIFA	PIFA
WNC	PIFA	PIFA
WNC	PIFA	PIFA
WNC	PIFA	PIFA
WNC	PIFA	PIFA
WNC	PIFA	PIFA
WNC	PIFA	PIFA
WLAN		
Foxconn	3rd WiFi BG	Foxconn Wireless LAN Atheros HB63 BG (HM)
Foxconn	3rd WiFi BG	Foxconn Wireless LAN Atheros HB63 BG (HM)
Foxconn	3rd WiFi BG	Foxconn Wireless LAN Atheros HB63 BG (HM)
Foxconn	3rd WiFi BG	Foxconn Wireless LAN Atheros HB63 BG (HM)
Foxconn	3rd WiFi BG	Foxconn Wireless LAN Atheros HB63 BG (HM)
Foxconn	3rd WiFi BG	Foxconn Wireless LAN Atheros HB63 BG (HM)
Foxconn	3rd WiFi BG	Foxconn Wireless LAN Atheros HB63 BG (HM)
Foxconn	3rd WiFi BG	Foxconn Wireless LAN Atheros HB63 BG (HM)

Online Support Information

This section describes online technical support services available to help you repair your Acer Systems.

If you are a distributor, dealer, ASP or TPM, please refer your technical queries to your local Acer branch office. Acer Branch Offices and Regional Business Units may access our website. However some information sources will require a user i.d. and password. These can be obtained directly from Acer CSD Taiwan.

Acer's Website offers you convenient and valuable support resources whenever you need them.

In the Technical Information section you can download information on all of Acer's Notebook, Desktop and Server models including:

- Service guides for all models
- User's manuals
- Training materials
- Bios updates
- Software utilities
- Spare parts lists
- TABs (Technical Announcement Bulletin)

For these purposes, we have included an Acrobat File to facilitate the problem-free downloading of our technical material.

Also contained on this website are:

- Detailed information on Acer's International Traveler's Warranty (ITW)
- Returned material authorization procedures
- An overview of all the support services we offer, accompanied by a list of telephone, fax and email contacts for all your technical queries.

We are always looking for ways to optimize and improve our services, so if you have any suggestions or comments, please do not hesitate to communicate these to us.

Numerics

- 3G Cover
 - Removing 45
 - Replacing 134
- 3G Module
 - Removing 52, 129

A

- Antennas
 - Removing 95
 - Replacing 97

B

- Battery Pack
 - Removing 44
 - Replacing 136
- BIOS
 - ROM size 15
 - ROM type 15
 - vendor 15
 - Version 15
- BIOS Utility 21–31
 - Advanced 26
 - Boot 29
 - Exit 30
 - Navigating 21
 - Save and Exit 30
 - Security 26
 - System Security 30
- Bluetooth Module
 - Removing 73, 113
- Board Layout
 - Top View 157
- brightness
 - hotkeys 12
- Button Board
 - Removing 61, 121

C

- Camera Board
 - Removing 89
 - Replacing 103
- caps lock
 - on indicator 8

- Card Reader Board
 - Removing 64, 120
- Common Problems 138
- CPU Fan
 - Removing 77, 110
- CRT Board
 - Removing 66, 119
- CRT Cable
 - Removing 82
 - Replacing 106

D

- DIMM Module
 - Removing 49, 132
- Display 3
- display
 - hotkeys 12

E

- Euro Key 13
- External Module Disassembly
 - Flowchart 43

F

- Features 1
- FLASH Utility 31
- Flash Utility 31
- FRU (Field Replaceable Unit) List 163

H

- Hard Disk Drive Module
 - Removing 47, 132
- HDD Cover
 - Removing 45
 - Replacing 134
- Hibernation mode
 - hotkey 12
- Hinge Covers
 - Removing 57, 127
- Hot Keys 10

I

Indicators 8
Intermittent Problems 151
Internal Microphone Failure 146
Internal Speaker Failure 144

J

Jumper and Connector Locations 157
 Top View 157

K

Keyboard
 Removing 55, 127
Keyboard Failure 142

L

LAN Board
 Removing 68, 117
LCD Bezel
 Removing 87
 Replacing 104
LCD Brackets
 Removing 92
 Replacing 99
LCD Cable
 Removing 92
 Replacing 99
LCD Failure 141
LCD Module
 Removing 70, 114
LCD Module Disassembly
 Flowchart 86
LCD Module Reassembly Procedure 97
LCD Panel
 Removing 90
 Replacing 102
LED Board
 Removing 75
 Replacing 111
Lower Covers
 Removing 45
 Replacing 134

M

Main Module Reassembly Procedure 105
Main Unit Disassembly

 Flowchart 54
Mainboard
 Removing 82
 Replacing 106
media access
 on indicator 8
Memory Check 138
Memory Cover
 Removing 45
 Replacing 134
Microphone
 Removing 90
 Replacing 102
Model Definition 174

N

No Display Issue 139
num lock
 on indicator 8

O

ODD Failure 148
Online Support Information 189

P

Panel 4
 left 4
PC Card 8
POST Codes
 Reference Tables 152
Power On Failure 138

R

RTC Battery
 Removing 84
 Replacing 84

S

Speaker Module
 Removing 79
 Replacing 108
speakers
 hotkey 12
System
 Block Diagram 3

T

Test Compatible Components 175

Thermal Module

Removing 85, 105

Top 157

Touch Pad

hotkey 12

Touch Pad Failure 143

TouchPad Bracket

Removing 61

Replacing 121

Troubleshooting

Built-in KB Failure 142

Internal Microphone 146

Internal Speakers 144

LCD Failure 141

No Display 139

ODD 148

Other Failures 150

Power On 138

Touch Pad 143

USB 148

WLAN 150

U

Undetermined Problems 151

Upper Cover

Removing 58, 124

USB Failure (Rightside) 148

utility

BIOS 21–31

V

volume

hotkeys 12

W

Windows 2000 Environment Test 176

Wireless Function Failure 150

WLAN Board

Removing 50, 130

