

TravelMate α-550

Service Guide

Service guide files and updates are available on the ACER/CSD web; for more information, please refer to <http://csd.acer.com.tw>

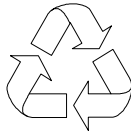

100% Recycled Paper

PART NO.: HLX.0550.001

PRINTED IN TAIWAN

Revision History

Please refer to the table below for the updates made on TravelMate α-550 service guide.

Date	Chapter	Updates

Copyright

Copyright © 1999 by Acer Incorporated. All rights reserved. No part of this publication may be reproduced, transmitted, transcribed, stored in a retrieval system, or translated into any language or computer language, in any form or by any means, electronic, mechanical, magnetic, optical, chemical, manual or otherwise, without the prior written permission of Acer Incorporated.

Disclaimer

The information in this guide is subject to change without notice.

Acer Incorporated makes no representations or warranties, either expressed or implied, with respect to the contents hereof and specifically disclaims any warranties of merchantability or fitness for any particular purpose. Any Acer Incorporated software described in this manual is sold or licensed "as is". Should the programs prove defective following their purchase, the buyer (and not Acer Incorporated, its distributor, or its dealer) assumes the entire cost of all necessary servicing, repair, and any incidental or consequential damages resulting from any defect in the software.

Acer is a registered trademark of Acer Corporation.

Intel is a registered trademark of Intel Corporation.

Pentium and Pentium II/III are trademarks of Intel Corporation.

Other brand and product names are trademarks and/or registered trademarks of their respective holders.

Conventions

The following conventions are used in this manual:

Screen messages	Denotes actual messages that appear on screen.
NOTE	Gives bits and pieces of additional information related to the current topic.
WARNING	Alerts you to any damage that might result from doing or not doing specific actions.
CAUTION	Gives precautionary measures to avoid possible hardware or software problems.
IMPORTANT	Reminds you to do specific actions relevant to the accomplishment of procedures.

Preface

Before using this information and the product it supports, please read the following general information.

1. This Service Guide provides you with all technical information relating to the BASIC CONFIGURATION decided for Acer's "global" product offering. To better fit local market requirements and enhance product competitiveness, your regional office MAY have decided to extend the functionality of a machine (e.g. add-on card, modem, or extra memory capability). These LOCALIZED FEATURES will NOT be covered in this generic service guide. In such cases, please contact your regional offices or the responsible personnel/channel to provide you with further technical details.
2. Please note WHEN ORDERING FRU PARTS, that you should check the most up-to-date information available on your regional web or channel. If, for whatever reason, a part number change is made, it will not be noted in the printed Service Guide. For ACER-AUTHORIZED SERVICE PROVIDERS, your Acer office may have a DIFFERENT part number code to those given in the FRU list of this printed Service Guide. You MUST use the list provided by your regional Acer office to order FRU parts for repair and service of customer machines.

Chapter 1	System Specifications	1
	Features	1
	System Block Diagram	3
	Board Layout	4
	Top View	4
	Bottom View	5
	Outlook View	6
	Front View	6
	Left Panel	8
	Right Panel	9
	Rear Panel	10
	Bottom Panel	11
	Indicators	12
	Lock Keys	14
	Embedded Numeric Keypad	15
	Windows Keys	16
	Hot Keys	17
	Keyboard Ergonomics	18
	Touchpad	19
	Touchpad Basics	19
	Launch Keys	21
	Hardware Specifications and Configurations	23
Chapter 2	System Utilities	37
	BIOS Setup Utility	37
	Navigating the BIOS Utility	37
	Main	38
	System Devices	39
	Security	40
	Others	42
	Boot	43
	Exit	44
	BIOS Flash Utility	45
	System Utility Diskette	45
	System Diagnostic Diskette	45
	Running Diagnostics Program	46
Chapter 3	Machine Disassembly and Replacement	51
	General Information	52
	Before You Begin	52
	Disassembly Procedure Flowchart	53
	Removing the HDD Module/Thermal Module/CPU and DVD-ROM	56
	Removing the LCD Module/the Keyboard and the System Window	57
	Removing the LCD Module	57
	Removing the keyboard	57
	Removing the system window	57
	Disassembling the Main Unit	58
	Separate the main unit into the logic upper and the logic lower assembly ...	58
	Disassembling the logic upper	58
	Disassembling the logic lower	60
	Disassembling the LCD Module-15 Inch	62
	Disassembling the External Modules	63
	Disassembling the HDD Module	63
	Disassembling the Floppy Disk Drive Module	63

Table of Contents

Disassembling the DVD-ROM Module	63
Chapter 4 Troubleshooting	65
System Check Procedures	66
External Diskette Drive Check	66
External CD-ROM Drive Check	66
Keyboard or Auxiliary Input Device Check	67
Memory Check	67
Power System Check	67
Touchpad Check	68
Power-On Self-Test (POST) Error Message	69
Index of Error Messages	70
Index of Symptom-to-FRU Error Message	73
Intermittent Problems	76
Undetermined Problems	77
Index of AFlash BIOS Error Message	78
Index of PQA Diagnostic Error Code, Message	79
Chapter 5 Jumper and Connector Locations	81
Top View	81
SW1 Settings (Lid switch)	84
SW2 Settings	84
Bottom View	85
Chapter 6 FRU (Field Replaceable Unit) List	99
Appendix A Model Definition and Configuration	116
Main Features	117
Appendix B Test Compatible Components	119
Microsoft Windows XP Environment Test	120
Appendix C Online Support Information	121
Index	123

System Specifications

Features

This computer was designed with the user in mind. Here are just a few of its many features:

Performance

- Intel® Pentium™ III or Intel® Celeron™ processor with one-die level 2 cache
- 128 MB memory onboard and one memory upgrade slot
- Large LCD display with adjustable video memory
- High-capacity, Enhanced-IDE hard disk
- Lithium-Ion main battery pack
- Power management system
- DualView capability
- Simultaneous LCD and CRT display

Display

- 14.1" Thin-Film Transistor (TFT) liquid-crystal display (LCD) displaying 16.7 million colors at 1024X768 eXtended Graphics Array (XGA) resolution -or- 15.0" TFT LCD displaying 16.7 million colors at 1400X1050 Super eXtended Graphics Array Plus (SXGA+) resolution
- AGP 4X support
- Video memory allocation from main memory (BIOS)
- Simultaneous LCD and CRT display

Multimedia

- 16-bit high-fidelity stereo audio with 3-D sound
- Built-in dual stereo speakers
- Internal optical drive (CD-ROM, DVD-ROM, or DVD/CD-RW combo)
- Audio DJ (CD playback) feature
- S-video (NTSC/PAL) output

Connectivity

- High-speed 56Kbps V.90 fax/data software modem
- Ethernet/Fast Ethernet (10/100 Mbps)
- CarBus PC Card slots
- Universal Serial Bus (USB) ports
- IEEE 1394 port

Human-centric design and ergonomics

- All-in-one design (CD or DVD, floppy drive, and hard disk)
- Sleek, smooth and stylish design
- Full-sized keyboard
- Wide and curved palm rest
- Ergonomically-centered touchpad pointing device
- Launch keys (supports Audio DJ feature)

Expansion

- Upgradeable memory and hard disk

Keyboard and Pointing Device

- 85-/86-key Windows keyboard
- Ergonomically-centered touchpad pointing device

I/O Ports

- One type III or two type I/II PC Card slots (PCMCIA, CardBus)
- One RJ-11 modem jack (V.90, 56K)
- One RJ-45 network jack (Ethernet 10/100)
- One DC-in jack
- One parallel port (ECP/EPP)
- One external monitor port
- One keyboard/mouse port (PS/2)
- One speaker/headphone-out jack (3.5mm minijack)
- One microphone-in jack (3.5mm minijack)
- One video-out jack (S-video)
- Two Universal Serial Bus (USB) ports
- One IEEE 1394 port

System Block Diagram

System Block Diagram

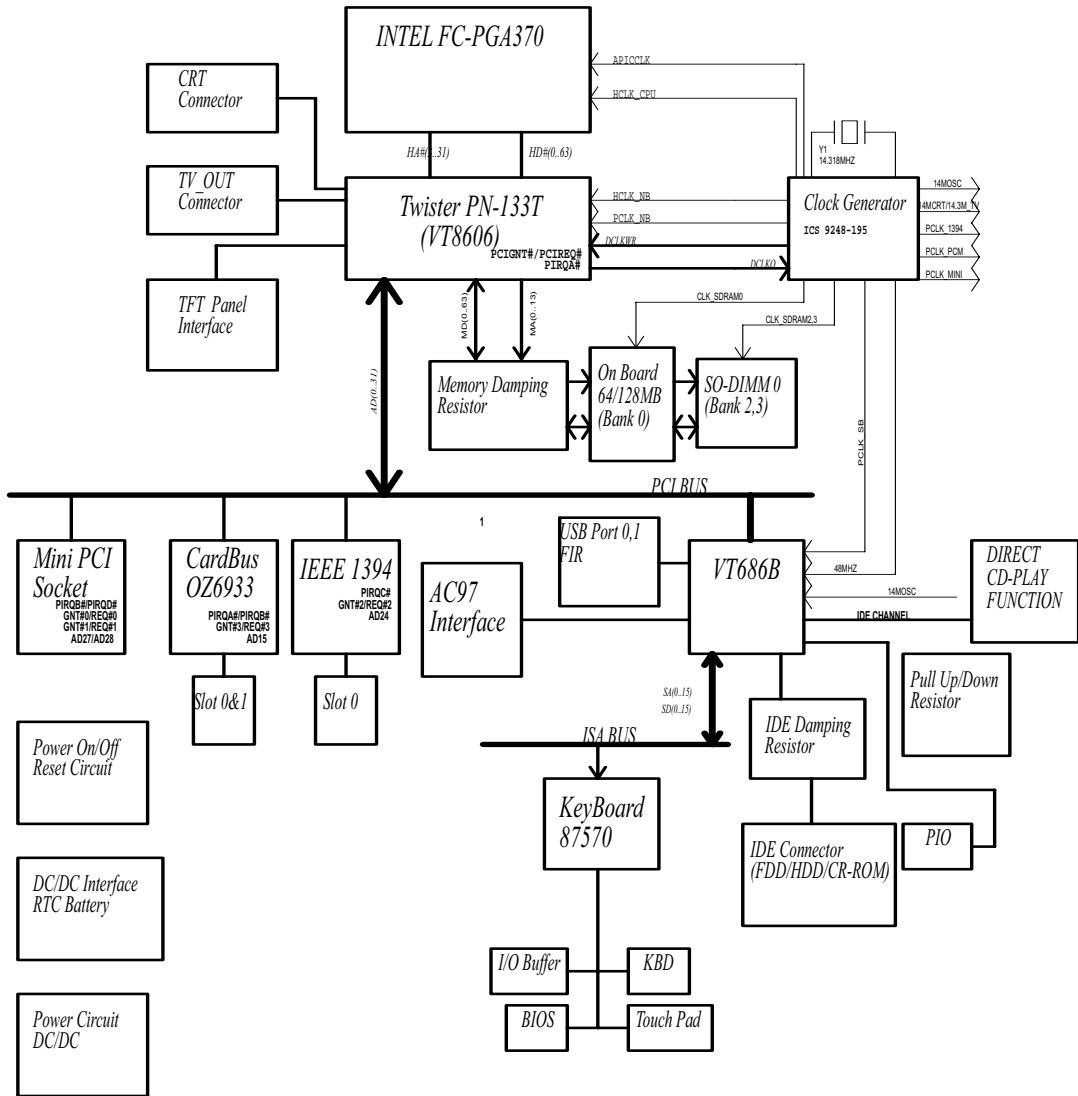

Board Layout

Top View

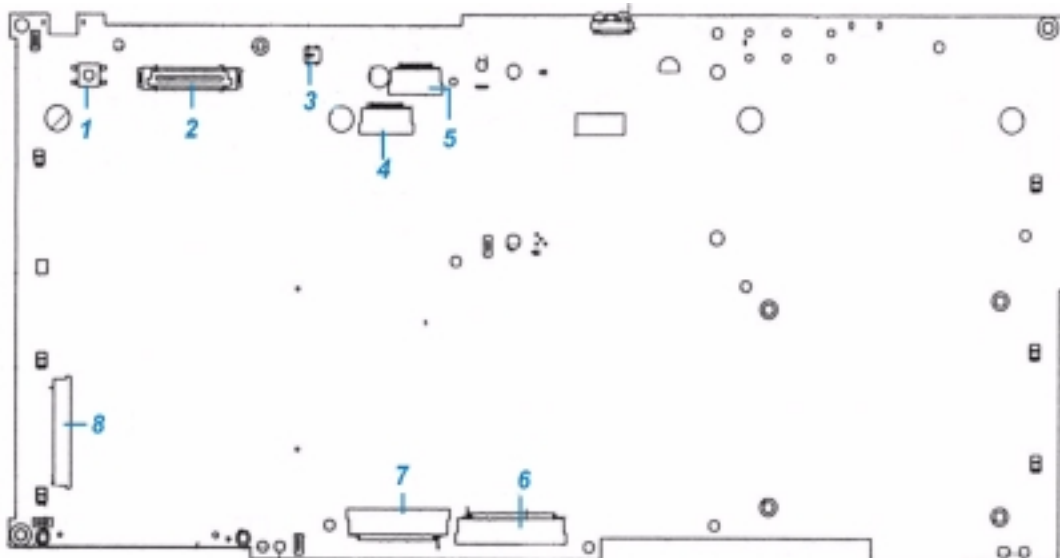

- | | | | |
|---|-------------------------|---|--|
| 1 | Power On/Off LID switch | 5 | Software debug only, normally shipping on this connector |
| 2 | LCD connector | 6 | FDD connector |
| 3 | LID switch | 7 | Internal keyboard connector |
| 4 | System board connector | 8 | Switch board connector |

Bottom View

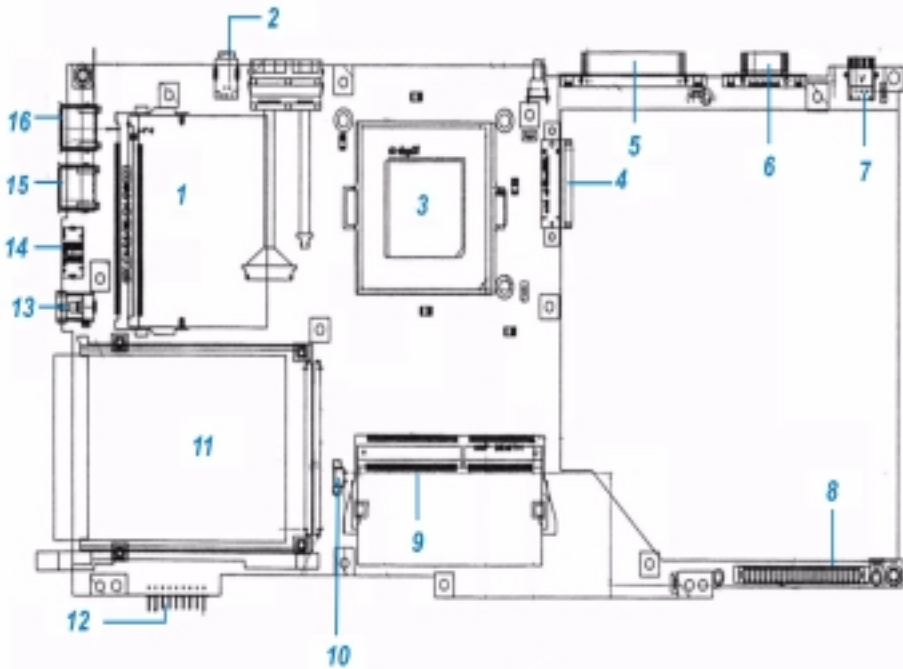



- | | | | |
|---|-----------------------------------|----|--|
| 1 | Mini PCI connector | 9 | So-DIMM connector for SDRAM only |
| 2 | 1394 Connector | 10 | CPU fan connector |
| 3 | CPU socket for FC-PGA370 | 11 | PCMCIA socket connector |
| 4 | CD-ROM connector | 12 | Battery connector |
| 5 | Print port connector | 13 | AC adapter input connector |
| 6 | CRT connector | 14 | PS/2 keyboard and PS/2 mouse connector |
| 7 | TV out connector for S-video only | 15 | USB connector |
| 8 | HDD connector | 16 | USB connector |

Outlook View

A general introduction of ports allow you to connect peripheral devices, as you would with a desktop PC.

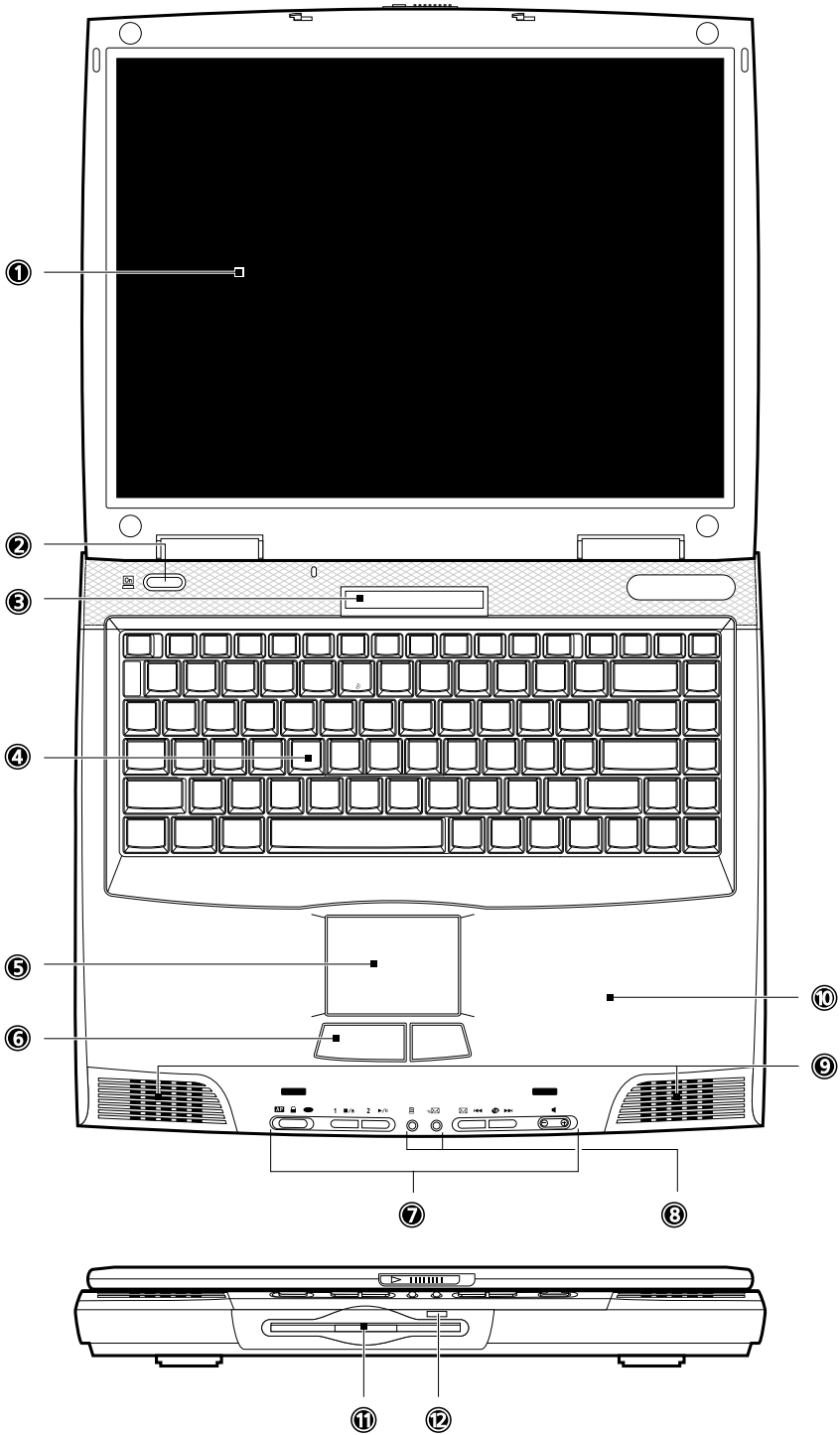
Front View



#	Icon	Item	Description
1	1	Display screen	Also called LCD (liquid-crystal display), displays computer output.
2		Power button	Turns on the computer power.
3		Status LCD	LCD that display icons to show the status of the computer and its functions and components.
4		Keyboard	Inputs data into your computer.
5		Touchpad	Touch-sensitive pointing device which functions like a computer mouse.
6		Click buttons (left and right)	The left and right buttons function like the left and right mouse buttons.
7		Launch keys	Buttons for launching frequently-used programs. Please see User's Guide "Launch keys" on page 22 for more details.
8		Status indicators	Shows the power and email status.
9		Speaker	Outputs sound.
10		Palmrest	Comfortable support area for your hands when you use the computer.
11		Floppy drive	Accepts a 3.65-inch diskette.
12		Floppy drive eject button	Press to eject the diskette from the floppy drive.



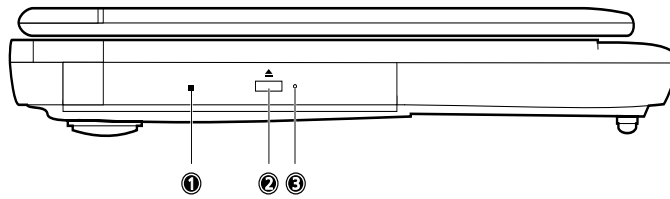



Left Panel

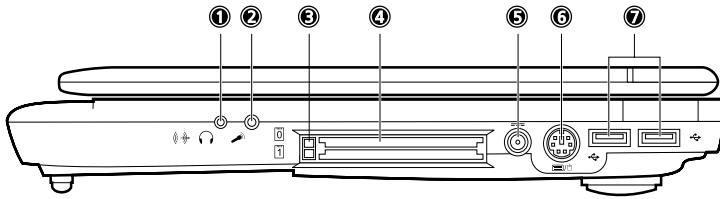

#	Icon	Item	Description
1		Optical drive	Depending on your model: --CD-ROM drive reads CDs --DVD-ROM drive reads CDs and DVDs --DVD/CD-RW combo drive reads CDs and DVDs, and writes to CD-Rs and CD-RWs.
2		Optical drive eject button	Ejects the disc from the optical drive.
3		Optical drive emergency eject hole	Eject the disc from the optical drive when the computer is turned off. See User's Guide "How do I eject the optical drive tray with the computer turned off?" on page 78 for more details.





Right Panel

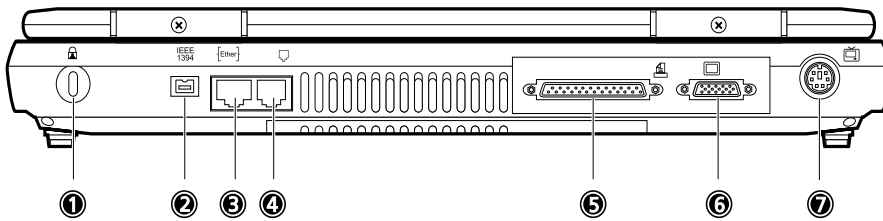

#	Icon	Item	Description
1		Speaker/headphone-out jack	Connects to audio line-out devices (e.g., speakers, headphones).
2		Microphone-in jack	Connects and external microphone.
3		PC Card eject buttons	Eject the selected PC Card from its slot.
4		PC Card slots	Accepts one Type III or two TypeII/ PC Card(s).
5		DC-in jack	Connects to the AC adapter.
6		PS/2 port	Connects to a PS/2-compatible device (e.g., PS/2 keyboard/mouse/keypad).
7		USB port (two)	Connects to the USB devices (e.g., USB mouse).

Rear Panel



#	Icon	Item	Description
1		Security keylock	Connects to a Kensington-compatible computer security lock.
2	IEEE 1394	IEEE 1394 port	Connects to a IEEE 1394 compatible device (e.g., digital camcorder).
3	{Ether}	Network jack	Connects to an Ethernet 10/100-based network.
4		Modem jack	Connects a phone line (only for models with an internal fax/data modem).
5		Parallel port	Connects to a parallel device (e.g., parallel printer).
6		External display port	Connects to a display monitor.
7		Video-out port	Connects to a display device with S-video input.

Bottom Panel

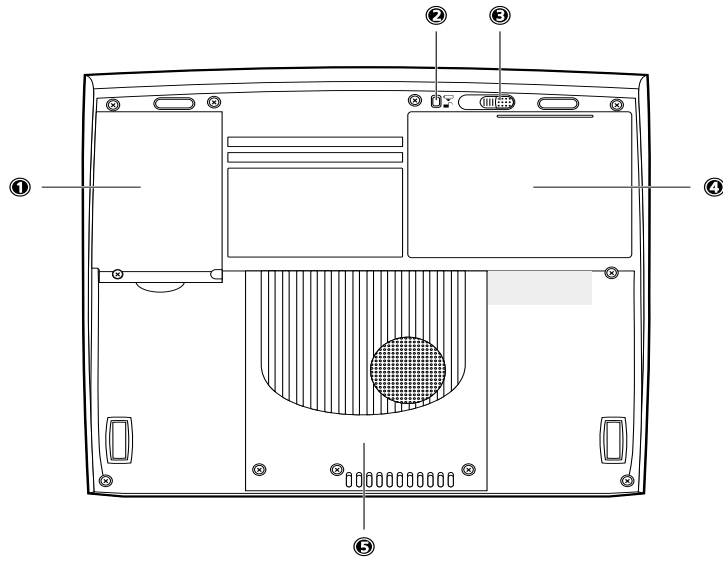





#	Icon	Item	Description
1		Hard disk bay	Houses the computer's hard disk.
2		Battery release button	Press and hold to release the battery latch.
3		Battery release latch	Unlatches the battery to remove the battery pack.
4		Battery bay	Houses the computer's battery pack.
5		Memory compartment	Houses the computer's main memory.

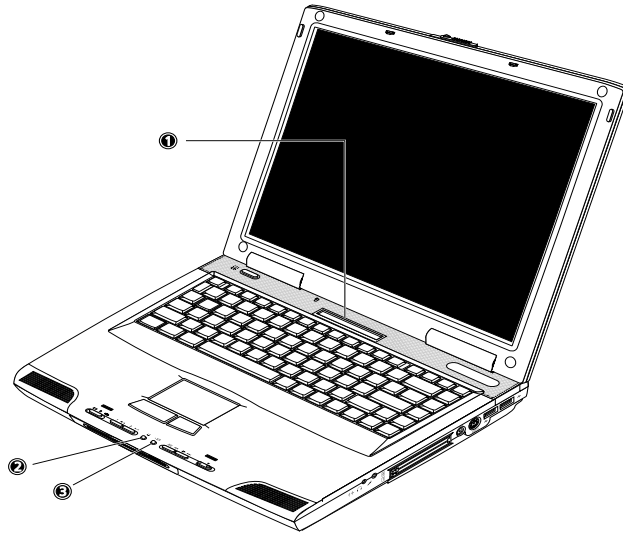



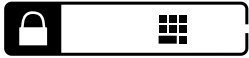
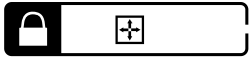
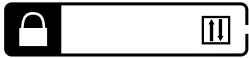



Indicators

The computer has an easy-to-read status LCD (1) located above the keyboard. Two status indicators, power (2), and email (3) are located near the front of the computer.





The status LCD displays icons that show the status of the ocmputer and its components..

Icon	Function	Description
	Caps lock	Caps Lock is activated.
	Num lock	Numeric Lock (for embedded keypad) is activated.
	Pad lock	Pad Lock (for embedded keypad) is activated.
	Scroll lock	Scroll Lock is activated.
	Optical drive/Hard disk activity	CD or DVD drive or hard disk is being accessed.
	Floppy drive activity	Floppy drive is being accessed.
	PC Card activity	PC Card is being accessed.

Icon	Function	Description
	AC power	Computer is running on AC power.
	Battery charge	Battery is being charged.
	Battery full	Battery is fully charge.
	Battery gauge	Batter is 75 to 100 percent full.
	Battery gauge	Batter is 31 to 75 percent full, and battery is running low.
	Battery gauge	Battery is 6 to 30 percent full, and battery is running low. Note: Charge the battery as soon as possible.
	Battery gauge	Battery is critically-low. Note: Battery gauge icon is blinking.
	Battery gauge	Battery temperature is too high. Note: Save your work and shut down your computer to let the battery cool down.
	Battery gauge	Battery is not installed.



In addition to the status LCD, the computer includes power and email status indicators.

Icon	Function	Description
	Power	Lights when the computer is on.
	Email	Lights when incoming email is received. To launch your email program and read the incoming email, press the email button beside this indicator.

Lock Keys

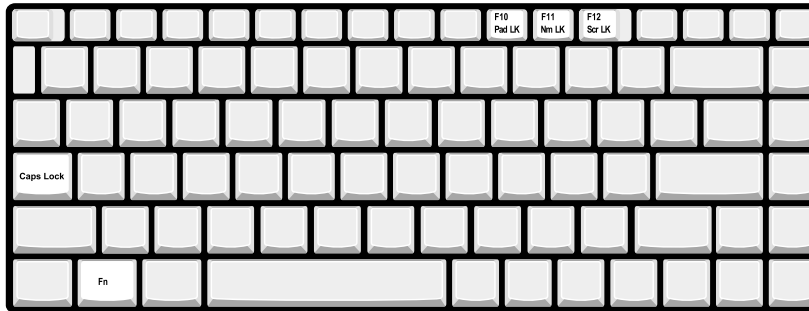
The keyboard has three lock keys which you can toggle on and off.





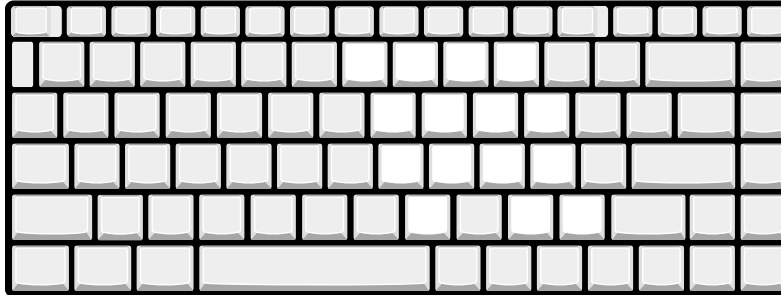

Lock Key	Description
Caps Lock	When Caps Lock is on, all alphabetic characters typed are in uppercase.
Pad Lock (Fn-F10)	When Pad Lock is on, the embedded keypad is in cursor mode. The keys function as a directional keypad including Insert and Delete keys.
Num lock (Fn-F11)	When Num Lock is on, the embedded keypad is in numeric mode. The keys function as a calculator (complete with the arithmetic operators +, -, *, and /). Use this mode when you need to do a lot of numeric data entry. A better solution would be to connect an external keypad. See User's Manual "External keyboard" on page 40.
Scroll lock (Fn-F12)	When Scroll Lock is on, the screen moves one line up or down when you press  and  respectively. Scroll Lock does not work with some applications.

Embedded Numeric Keypad

The embedded numeric keypad functions like a desktop numeric keypad. It is indicated by small characters located on the upper right corner of the keycaps. The embedded keypad can function in numeric mode or cursor-control mode.



Desired Access	Num Lock On	Pad Lock On
Number keys on embedded keypad	Type numbers in a normal manner.	Hold  while typing numbers.
Cursor-control keys on embedded keypad	Hold  while using cursor-control keys.	Use cursor-control keys in a normal manner.
Main keyboard keys	Hold Fn while typing letters on embedded keypad. Also hold down  for capital letters.	Hold Fn while typing letters on embedded keypad. Also hold down  for capital letters.

Windows Keys

The keyboard has two keys that perform Windows-specific functions.

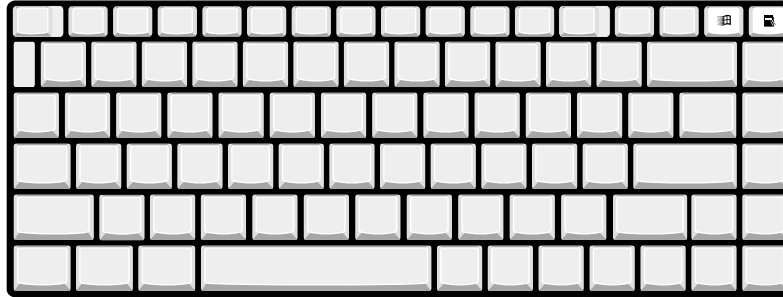



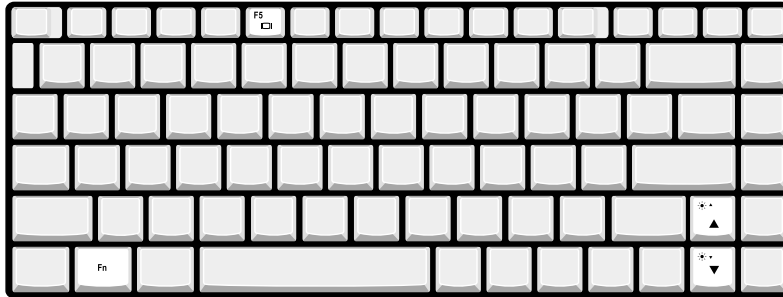

Key	Icon	Description
Windows logo key		Start button. Combinations with this key perform special functions. Below are a few examples: <ul style="list-style-type: none">+ Tab (Activates next taskbar button)+ E (Explores My Computer)+ F (Finds Document)+ M (Minimizes All) + Windows logo key + M (Undoes Minimize All)+ R (Displays Run dialog box)
Application key		Opens a context menu (same as a right-click).

Hot Keys

The computer uses hotkey or key combinations to perform functions such as controlling the screen brightness and specifying where to display output.



Hot Key	Icon	Function	Description
Fn-F5		Display toggle	Switches display output between the display screen, external monitor (if connected) and both the display screen and external monitor.
Fn- 		Brightness Up	Increases the screen brightness.
Fn- 		Brightness Down	Decreases the screen brightness.

NOTE: When activating hotkeys, press and hold the **Fn** key before pressing the other key in the hotkey combination.

Keyboard Ergonomics

Located below the keyboard, the wide and curved palm rest is ergonomically designed to provide you with a very comfortable place to rest your hands while you type.



Touchpad

The built-in touchpad is a PS/2-compatible pointing device that senses movement on its surface. This means the cursor responds as you move your finger on the surface of the touchpad. The central location on the palm rest provides you optimum comfort and support.

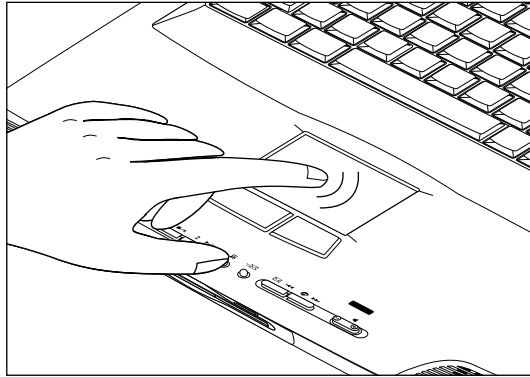

NOTE: If you are using an external PS/2 mouse, the touchpad is automatically disabled. You can enable or disable this function in BIOS.

Touchpad Basics

The following teaches you how to use the touchpad:

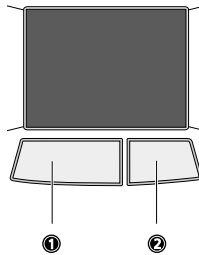

- Move your finger across the touchpad to move the cursor.
- Press the left (1) and right (2) buttons located on the edge of the touchpad to do selection and execution functions. These two buttons are similar to the left and right buttons on a mouse. Tapping on the touchpad produces similar results.

Function	Left Button	Righ Button	Tap
Execute	Click twice quickly		Tap twice (at the same speed as double-clicking the mouse button)
Select	Click once		Tap once
Drag	Click and hold, then use finger to drag the cursor on the touchpad		Tap twice (at the same speed as double-clicking a mouse button) then hold finger to the touchpad on the second tap to drag the cursor
Access context menu		Click once	
Scroll			

NOTE: Keep your fingers dry and clean when using the touchpad. Also keep the touchpad dry and clean. The touchpad is sensitive to finger movements. Hence, the lighter the touch, the better the response. Tapping too hard will not increase the touchpad's responsiveness.





Launch Keys

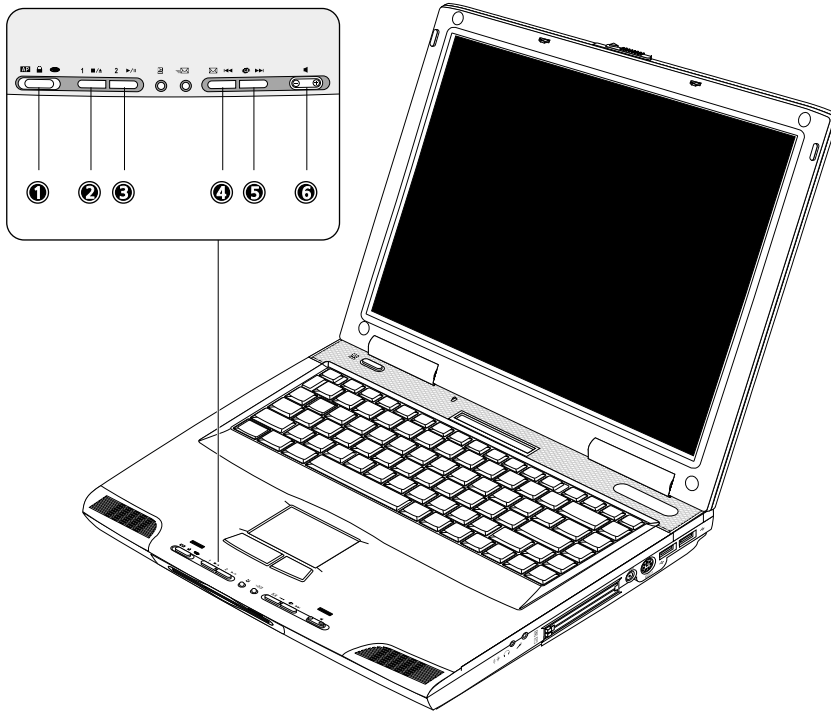

Located near the front end of the computer (between the speakers) are launch keys that perform various functions.

Depending on the set mode, these launch keys may be used to launch applications for play back music CDs.

NOTE: The Audio DJ feature is also available even when the computer is off.



#	Icon	Item	Description
1		Mode Switch	This sets the launch key mode. Slide the switch to the desired mode.
1			AP (Application) mode.
1			Lock mode
1			Audio DJ mode
2	1	1 (AP mode)	Launches a user-configurable application.
2		Stop/Eject (Audio DJ mode)	Stop playback of the music CD; when playback is stopped, ejects the drive tray.

#	Icon	Item	Description
3	2	2 (AP mode)	Launches a user-configurable application.
3	▶/	Play/Pause (Audio DJ mode)	Plays and pauses playback of the music CD.
4		Email (AP mode)	Launches your email program.
4	⏮	Previous Track (Audio DJ mode)	Jumps to the previous track on the music CD. (AP mode)
5		Internet Browser (AP mode)	Launches your internet browser.
5	⏭	Next Track (Audio DJ mode)	Jumps to the next track on the music CD.
6		Volume Buttons	Decreases (-) or increase (+) the volume.

Hardware Specifications and Configurations

Processor

Item	Specification
CPU type	Pentium III 1.0G/Pentium III 1.13G
CPU package	FC-PGA package/FC-PGA2 package
CPU core voltage	1.75V/1.475V
CPU I/O voltage	1.25V/1.25V

BIOS

Item	Specification
BIOS vendor	Phoenix
BIOS Version	1.0
BIOS ROM type	Flash ROM
BIOS ROM size	512KB
BIOS package	TSOP
Supported protocols	ACPI 1.0b, PC Card 95, SM BIOS 2.3, EPP/IEEE 1284, ECP/IEEE 1284 1.7 & 1.9, PCI 2.2, PnP 1.0a, DMI 2.0, PS/2 keyboard and mouse, USB, VESA VGA BIOS, CD-ROM bootable,
BIOS password control	Set by setup manual

Second Level Cache

Item	Specification
Cache controller	Built-in CPU
Cache size	128KB/512KB
1st level cache control	Always enabled
2st level cache control	Always enabled
Cache scheme control	Fixed in write-back

System Memory

Item	Specification
Memory controller	Via Twister-T
Onboard memory size	128MB
DIMM socket number	1 sockets (2 banks)
Supports memory size per socket	512MB
Supports maximum memory size	640MB
Supports DIMM type	Synchronous DRAM
Supports DIMM Speed	100MHz or 133 MHz
Supports DIMM voltage	3.3V
Supports DIMM package	144-pin soDIMM
Memory module combinations	You can install memory modules in any combinations as long as they match the above specifications.

Memory Combinations

On Board	Slot 1	Total Memory
128 MB	0 MB	128 MB
128 MB	64 MB	192 MB
128 MB	128 MB	256 MB
128 MB	256 MB	384 MB
128 MB	512 MB	640 MB

Above table lists some system memory configurations. You may combine DIMMs with various capacities to form other combinations.

NOTE: The shipping specification for DIMM combination is 128MB in slot 1..

LAN Interface

Item	Specification
Supports LAN protocol	10/100 Mbps
LAN connector type	RJ45
LAN connector location	Rear side

Modem Interface

Item	Specification
Data modem data baud rate (bps)	56K
Supports modem protocol	V.90 MDC
Modem connector type	RJ11
Modem connector location	Rear side

Floppy Disk Drive Interface

Item	Specification		
Vendor & model name	Mitsumi D353G		
Floppy Disk Specifications			
Media recognition	2DD (720KB)	2HD (1.2MB, 3-mode)	2HD (1.44MB)
Sectors/track	9	15	18
Tracks	80	80	80
Rotational speed (RPM)	300	360	300
Read/write heads	2		
Encoding method	MFM/FM		
Power Requirement			
Input Voltage (V)	+5V +/- 10%		

Hard Disk Drive Interface

Item	Specification					
Vendor & Model Name	TOSHIBA 15G (MK1517)	IBM 15G (IC25N015AT D)	TOSHIBA 20G (MK2017)	IBM 20G (IC25N020AT D)	TOSHIBA 30G (MK3017)	IBM 30G (IC25N030AT D)
Capacity (MB)	15000	15000	20000	20000	30000	30000
Bytes per sector	512	512	512	512	512	512
Data heads	2	2	3	3	4	4
Drive Format						

Hard Disk Drive Interface

Item	Specification					
Disks	1	1	2	2	2	2
Spindle speed (RPM)	4200 RPM	4200 RPM	4200RPM	4200RPM	4200RPM	4200RPM
Performance Specifications						
Buffer size	2048KB	512KB	2048KB	2048KB	2048KB	2048KB
Interface	ATA-5	ATA-5	ATA-5	ATA-5	ATA-5	ATA-5
Max. media transfer rate (disk-buffer, Mbytes/s)	216	235	287	216	235	287
Data transfer rate (host-buffer, Mbytes/s)	100 MB/Sec. Ultra DMA mode-5	100 MB/Sec. Ultra DMA mode-5	100 MB/Sec. Ultra DMA mode-5	100 MB/Sec. Ultra DMA mode-5	100 MB/Sec. Ultra DMA mode-5	100 MB/Sec. Ultra DMA mode-5
DC Power Requirements						
Voltage tolerance	5V(DC) +/- 5%	5V(DC) +/- 5%	5V(DC) +/- 5%	5V(DC) +/- 5%	5V(DC) +/- 5%	5V(DC) +/- 5%

DVD-ROM Interface

Item	Specification	
Vendor & model name	Toshiba SD-C2502	
Performance Specification	With CD Diskette	With DVD Diskette
Transfer rate (KB/sec)	Sustained: Max 3.6Mbytes/sec	Sustained: Max 10.8Mbytes/sec
Data Buffer Capacity	128 KBytes	
Interface	IDE/ATAPI	
Applicable disc format	DVD: DVD-ROM (DVD-5, DVD-9, DVD-10, DVD-18), DVD-R (read, single border) CD: CD-DA, CD+(E)G, CD-MIDI, CD-TEXT, CD-ROM, CD-ROM XA, CD-I, CD-I Bridge (Photo-CD, Video-CD) Multisession CD (Photo-CD, CD-EXTRA, CD-R, CD-RW), CD-R (read), CD-RW (read)	
Loading mechanism	Load: Manual Release: (a) Electrical Release (Release Button) (b) Release by ATAPI command (c) Emergency Release	
Power Requirement		
Input Voltage	+5 V +/- 5 % (Operating) +/- 8 % (Start up)	

Audio Interface

Item	Specification
Audio Controller	CS 4299
Audio onboard or optional	Built-in
Mono or Stereo	Stereo
Resolution	20 bit stereo Digital to analog converter 18 bit stereo Analog to Digital converter
Compatibility	Microsoft PC98/PC99, AC97 2.1
Mixed sound source	Line-in, CD, Video, AUX
Voice channel	8/16-bit, mono/stereo
Sampling rate	44.1 KHz
Internal microphone	No
Internal speaker / Quantity	Yes
Supports PnP DMA channel	DMA channel 0 DMA channel 1
Supports PnP IRQ	IRQ3, IRQ5, IRQ7, IRQ9, IRQ10, IRQ11

Video Interface

Item	Specification
Chip vendor	VIA
Chip name	TWISTER-T
Chip voltage	Core/3.3V
Supports ZV (Zoomed Video) port	No

Video Resolutions Mode (for both LCD and CRT)

Resolution	8 bits (256 colors)	16 bits (High color)	24 bits (True color)	32 bits (True color)
640x480	Yes	Yes	Yes	Yes
720x480	Yes	Yes	Yes	Yes
800x600	Yes	Yes	Yes	Yes
848x480	Yes	Yes	Yes	Yes
1024x768	Yes	Yes	Yes	Yes
1152x864	Yes	Yes	Yes	Yes
1280x1024	Yes	Yes	Yes	Yes
1400x1050	Yes	Yes	Yes	Yes
1600x1200	Yes	Yes	Yes	Yes

Parallel Port

Item	Specification
Parallel port controller	VT686B
Number of parallel port	1
Location	Rear side
Connector type	25-pin D-type connector, in female type

Parallel Port

Item	Specification
Parallel port function control	Enable/Disable/Auto (BIOS or operating system chooses configuration) by BIOS Setup Note: Depending on your operating system, disabling an unused device may help free system resources for other devices.
Supports ECP/EPP/Bi-directional (PS/2 compatible)	Yes (set by BIOS setup) Note: When Mode is selected as EPP mode, "3BCh" will not be available.
Optional ECP DMA channel (in BIOS Setup)	DMA channel 1 and 3
Optional parallel port I/O address (in BIOS Setup)	3BCh, 278h, 378h
Optional parallel port IRQ (in BIOS Setup)	IRQ7, IRQ5

USB Port

Item	Specification
USB Compliancy Level	1.1
OHCI	USB 1.1
Number of USB port	2
Location	Right panel
Serial port function control	Enable/Disable by BIOS Setup

PCMCIA Port

Item	Specification
PCMCIA controller	OZ6933
Supports card type	Type-III/II
Number of slots	One type-III or Two type-II
Access location	Left side
Supports ZV (Zoomed Video) port	No ZV support
Supports 32 bit CardBus	Yes (IRQ11)

System Board Major Chips

Item	Controller
System core logic	VIA PN133/VT686B
Super I/O controller	Build in VT686B
Audio controller	Crystal 4299 AC 97 codes
Video controller	VIA Twister-T
Hard disk drive controller	VT686B
Keyboard controller	87570
RTC	VT686B

Keyboard

Item	Specification
Keyboard controller	NS 87570
Keyboard vendor & model name	Chicony MPO 130
Total number of keypads	87 keys with 101/102 key emulation

Keyboard

Item	Specification
Windows 95 keys	Yes
Internal & external keyboard work simultaneously	Yes

Battery

Item	Specification
Vendor & model name	Panasonic/SUMSUNG
Battery Type	Li-ion
Pack capacity	57Wh
Cell voltage	V/cell
Number of battery cell	8
Package configuration	4 cells in series, 2 series in parallel
Package voltage	14.8V

LCD Inverter Specification FOR 14.1"

Panel List

No.	LCD Type	Vendor	Model No.	Frequency range (Min./Typ./Max)	Lamp current (mArms) Min/Typ/Max
1	14.1" SVGA TFT	HANSTAR	HSD141PX11-A REV1	40/50/60KHz	20-6.5mA
2	14.1" SVGA TFT	IBM	ITXG77X	40/60/65HKz	2.5-6.4mA

General Description

This inverter is designed for the CCFL of α 550 14.1" LCD which are using on the α 550 notebook. We use two signals to control the LCD brightness. One is the **Enable**, which turn on and turn off the birightness of LCD. The other is the **PWM**, which tune the brightness by modulating the duty cycle. This inverter uses open loop control circuit and meets with safety requirements.

Features

1. +5V Fixed input voltage
2. Birghtness adjustment by PWM duty cycle
3. Current Limited function, meet with safety requirement

Inverter Characteristics

No.	Parameter	Symbol	Min.	Typ.	Max.	Unit	Conditions
1	Input voltage	+5V	4.75	4.85	4.95	V	
2	Input current	Iin	--	---	1A	A	
3	Lamp Current	IL	5.50	5.75	6.00	mArms	Enable= H, PWM Duty = 100%
				3.0		mArms	Enable = H, PWM Duty = 30%
4	Lamp voltage			625		Vrms	At IL = 6.0 mArms

Inverter Characteristics

No	Parameter	Symbol	Min.	Typ.	Max.	Unit	Conditions
5	Frequency	F	45	55	65	kHz	*2
6	Output power	Pout	--	--	4.5	W	
7	Efficiency	η	80	85	--	%	
8	Starting voltage	Vs	1500	---	---	Vrms	At 0 degree C
9	Enable	VIH	2.4			V	Compal Output H: 3.3V Compal Output L: 0V
		VIL	--	--	0.8	V	
10	PWM signals *3		--	150	--	Hz	PWM signal frequency
		VIH	2.4			V	Compal OUtput H: 5.0V
		VIL			0.8	V	Compal Output L: 0V
			30	--	100	%	
11	Current Waveform factor	$\frac{I_p}{I_{rms}}$	1.27	$\sqrt{2}$	1.56	Multiple	OR $\frac{I_{-p}}{I_{rms}}$ *8
12	Unbalance Rate	$\frac{I_p - I_{-p} }{I_{rms}}$	-10%	0	+10%	Multiple	

Environment: Temperature: Operating temperature: 0°C~55°C

Storage temperature: -20°C~80°C

Humidity: 0~90% without condensation

MTBF: 5000 hours

NO.1: 14.1" XGA TFT, HANSTAR, HSD141PX11-A

NOTE: Please pay attention to the following:

- *1. Make sure open lamp output voltage should be within starting voltage specification.
- *2. Inverter should pass human body safety test.
- *3. PWM signal is a 150HZ square wave. The backlight brightness is maximum when PWM at 100% duty cycle and backlight brightness is minimum when PWM at 30% duty cycle. Ps1. Duty cycle=T(on)/T(period)
- *4. The Inverter output should be 100% duty cycle when lamp current is less than 70% lamp current setting. (No matter of PWM signal)
- *5. Transformer voltage stress should not be over 85%.
- *6. Transformer temperature rising should be less than 30 degree C.

*7. Audio noise: less than 36db@10cm distance

NOTE: *8. Wave form requirement: $1.27 \leq I_p/I_{rms} \leq 1.8$

LCD Inverter Specification FOR 15.0"

Panel Lis

No.	LCD Type	Vendor	Model No.	Frequency range Min./Typ./Max	Lamp current (mArms) Min/Typ/Max
	15.0" XGA TFT	LG	LP150X1-G2CP (XGA TFT)	40/60/80KHz	3.0/6.0/8.0mA
	15.0" SXGA TFT	IBM	ITSX95C	40/.../60KHz	3.0/6.5/7.0mA

This Inverter is designed for the CCFL of α 550 15.1" LCD which are using on the α 550 notebook. We use PWM duty to control the LCD brightness.

Features

1. +5V fixed input voltage
2. Brightness adjustment by PWM duty cycle.
3. Build with Current limited function and open lamp protection function, meet with safety requirement.

Inverter Characteristics

No.	Parameter	Symbol	Min.	Typ.	Max.	Unit	Conditions
1	Input voltage	Vin	4.7	4.8	4.9	V	
2	Input current	Iin	--	---	1.2	A	
3	Lamp Current	ILmas	5.5	5.75	6.0	mArms	Enable= H, PWM Duty = 100%
				3.0		mArms	Enable = H, PWM Duty = 30%
4	Lamp voltage	VL	--	690	--	Vrms	At IL = 5.5 mArms
5	Frequency	F	45	55	65	kHz	*2
6	Output power	Pout	--	--	4.6	W	
7	Efficiency	η	80	85	--	%	
8	Starting voltage	Vs	1550			Vrms	At 0 degree C
9	Enable	VIH	2.4	--	--	V	Compal Output H: 3.3V Compal Output L: 0V
		VIL	--	--	0.8	V	
10	PWM signals *3		--	150	--	Hz	PWM signal frequency
		VIH	2.4			V	Compal OUtput H: 5.0V
		VIL			0.8	V	Compal Output L: 0V
			30	--	100	%	

Inverter Characteristics

No	Parameter	Symbol	Min.	Typ.	Max.	Unit	Conditions
11	Current Waveform factor	$\frac{I_p}{I_{rms}}$	1.27	$\sqrt{2}$	1.56	Multiple	OR *10 $\frac{I_{-p}}{I_{rms}}$
12	Unbalance Rate	$\frac{I_p - I_{-p} }{I_{rms}}$	-10%	0	+10%	Multiple	

Environment: Temperature: Operating temperature: 0°C~55°C

Storage temperature: -20°C~80°C

Humidity: 0~90% without condensation

MTBF: 5000 hours

NO.1: 14.1" XGA TFT, HANSTAR, HSD141PX11-A

NOTE: Please pay attention to the following:

- *1. Make sure open lamp output voltage should be within starting voltage specification.
- *2. Inverter should pass human body safety test.
- *3. Inverter should no smoking by any component open/short test.
- *5. Transformer temperature rising should be less than 30 degree C.
- *6. Transformer voltage stress should not be over 85% under any condition (turn on overshoot transient and line transient).
- *7. Wave from requirement: $1.27 \leq I_p/I_{rms} \leq 1.56$
- *8 Audio noise should be less than 36dB at 10cm distance.
- *9 I_p implies zero to positive peak value of lamp current.
- *10 I_{-p} implies zero to negative peak value of lamp current

LCD

Item	Specification			
Vendor & model name	IBM ITXG77X	Hannstar HSD141PX11_A Rev.1	LG LP105X1-G2CP	IBM ITSX95C
Mechanical Specifications				
LCD display area (diagonal, inch)	14.1	14.1	15.0	15.0
Display technology	TFT	TFT	TFT	TFT
Resolution	XGA (1024x768)	XGA (1024x768)	XGA (1024x768)	SXGA+ (1400x1050)
Supports colors	262K	262K	262K	262K
Optical Specification				
Brightness control	keyboard hotkey	keyboard hotkey	keyboard hotkey	keyboard hotkey
Contrast control	No	No	No	No
Suspend/Standby control	Yes	Yes	Yes	Yes
Electrical Specification				

LCD

Item	Specification			
Supply voltage for LCD display (V)	3.3	3.3	3.3	3.3
Supply voltage for LCD backlight (Vrms)	690	690	690	690

AC Adapter

Item	Specification
Vendor & model name	ADAPTER PA-1600-02 CA 60W 3 PINS
Input Requirements	
Maximum input current (A, @90Vac, full load)	1.8 A @ 90Vac 0.9 A @ 180Vac
Nominal frequency (Hz)	47 - 63
Frequency variation range (Hz)	47 - 63
Nominal voltages (Vrms)	90 - 264
Inrush current	The maximum inrush current will be less than 50A and 100A when the adapter is connected to 115Vac(60Hz) and 230Vac(50Hz) respectively.
Efficiency	It should provide an efficiency of 83% minimum, when measured at maximum load under 115V(60Hz).
Output Ratings (CV mode)	
DC output voltage	+18.8V~20.0V including the effects of line voltage variation, load current, ripple and noise
Noise + Ripple	300mvp-pmax (20MHz bandwidth) for resistor load
Output current	0 A (min.) 3.16 A (max.)
Output Ratings (CC mode)	
DC output voltage	+12V ~ +19V
Constant output	3.16A
Dynamic Output Characteristics	
Start-up time	2 sec. (@115Vac)
Hold up time	5 ms min. (@115 Vac input, full load)
Over Voltage Protection (OVP)	27 V
Short circuit protection	Output can be shorted without damage, and auto recovery
Electrostatic discharge (ESD)	15kV (at air discharge) 8kV (at contact discharge)
Dielectric Withstand Voltage	
Primary to secondary	2150 Vdc for 1 second
Leakage current	100uA at 254Vac
Regulatory Requirements	1. FCC class B requirements(USA) 2. VDE class B requirements(German) 3. VCCI classII requirements(Japan)

ACPI mode	Power Management
Mech. Off (G3)	<input type="checkbox"/> All devices in the system are turned off completely.
Soft Off (G2/S5)	<input type="checkbox"/> OS initiated shutdown. All devices in the system are turned off completely.

ACPI mode	Power Management
Working (G0/S0)	<input type="checkbox"/> Individual devices such as the CPU and hard disk may be power managed in this state.
S1 Sleeping State	<input type="checkbox"/> CPU Stop Clock <input type="checkbox"/> VGA Standby, turn off back-light <input type="checkbox"/> PCMCIA Standby <input type="checkbox"/> Hard Disk Spin Down motor <input type="checkbox"/> CD-ROM Spin Down <input type="checkbox"/> Super I/O Power down
S3 Sleeping State	<input type="checkbox"/> CPU set power down <input type="checkbox"/> VGA Suspend <input type="checkbox"/> PCMCIA Suspend <input type="checkbox"/> Audio Suspend <input type="checkbox"/> Hard Disk Power Down <input type="checkbox"/> CD-ROM Power Down <input type="checkbox"/> Super I/O Power Down
S4 Sleeping State	<input type="checkbox"/> System Saves all system states and data onto disk prior to power off the whole system.

Environmental Requirements

Item	Specification
Temperature	
Operating	+5~+35 °C
Non-operating	-20~+65 °C
Non-operating	-20~+65 °C (storage package)
Humidity	
Operating	20% to 80% RH, non-condensing
Non-operating	20% to 90% RH, non-condensing (unpacked)
Non-operating	20% to 90% RH, non-condensing (storage package)
Vibration	
Operating (unpacked)	5~500Hz: 1.0G
Non-operating (unpacked)	50~500Hz: 2.16G

Mechanical Specification

Item	Specification
Dimensions	322 (W) x 277 (D) x 37.5/43.3(H) for 14.1 inch model 322(W) x 277 (D) x 38/44 (H) for 15.0 inch model
Weight	6.68lbs for 14.1 inch model; 7.2 lbs for 15.0 inch model
I/O Ports	1 parallel port (25 pins) EPP/ECP capability, 1 CRT port (15 pins) supports DDC 2B, 1 external PS2/AT full keyboard connector & 1 TV-out connector, 1 microphone-in port, 1 headphone-out with SPDIF port, 1 AC adapter jack (2 pins), 1 type III or type II PCMCIA card bus slots, 2 USB ports (4 pins), 11394 port (4 pins), 1 RJ-11/RJ-45 port
Drive Bays	One
Material	Housing: Byer FR2000 Panel : Plastic
Indicators	Status LCD, Power LED, E-mail LED
Switch	Power, Lid, Application/Button Lock/CD-Play, Eject/Stop Button, Play/Pause Button, Reverse Button, Forward Button, Volume Down Button, volume up button

Memory Address Map

Memory Address	Size	Function
00100000h-000F0000h	512 KB	System BIOS
000CD000h-000C0000h		VGA BIOS
000C0000h-000A0000h	128 KB	Video memory (VRAM)
000A0000h-00000000h	640KB	Conventional memory

I/O Address Map

I/O Address	Function
000-00F	DMA controller-1
020-021	Interrupt controller-1
040-043	Timer 1
060, 064	Keyboard controller 38859 chip select
061	System speaker out
040B	DMA controller-1
061	System speaker
070-071	Real-time clock and NMI mask
080-08F	DMA page register
0A0-0A1	Interrupt controller-2
0C0-0DF	DMA controller-2
0F0-0FF	Numeric data processor
170-177	2nd EIDE device (CD-ROM) select
1F0-1F7	1st EIDE device (hard drive) select
220-22F	Audio
240-24F	Audio (optional)
278-27F	Parallel port 3
378,37A	Parallel port 1
3B0-3BB 3C0-3DF	Video Controller
3F0h-3F7	Standard Floppy Disk Controller
3F0-3F7	Floppy disk controller
480-48F, 4D6	DMA controller-1
4D0-4D1 CF8-CFF	PCI configuration register

IRQ Assignment Map

Interrupt Channel	Function(Hardware)
IRQ00	System timer
IRQ01	Keyboard
IRQ02	Programmable Interrupt Controller
IRQ03	Free
IRQ04	Free
IRQ05	1. PCI Audio 2. Internal Modem and Carbus Controller and IEEE 1394 host controller
IRQ06	Standard Floppy Disk Controller
IRQ07	ECP Printer Port (LPT1)
IRQ08	Real Time Clock
IRQ09	SCI IRQ used by ACPI bus

IRQ Assignment Map

Interrupt Channel	Function(Hardware)
IRQ10	S3 savage 4 O2Micro CardBus Control slot1
IRQ11	O2Micro CardBus Control slot1 USB Universal Host Control
IRQ12	PS/2 Mouse
IRQ13	Numeric data processor
IRQ14	Primary IDE channel (hard disk)
IRQ15	Secondary IDE channel (CD-ROM drive)

DMA Channel Assignment

DMA Channel	Function(Hardware)
00	Standard Floppy Disk Controller
01	ECP Printer Port (default)
02	Free
03	Free

System Utilities

BIOS Setup Utility

The BIOS Setup Utility is a hardware configuration program built into your computer's BIOS (Basic Input/Output System).

Your computer is already properly configured and optimized, and you do not need to run this utility. However, if you encounter configuration problems, you may need to run Setup. Please also refer to Chapter 4 Troubleshooting when problem arises.

To activate the BIOS Utility, press **F2** during POST (when "Press <F2> to enter Setup" message is prompted on the bottom of screen).

Main	System Devices	Security	Others	Boot	Exit
					Item Specific Help
System Time:	[11:21:00]				
System Date:	[09/11/2001]				
Floppy Drive:	1.44MB, 3½"				
Hard Disk:	IBM-DJSA-220-(PM)				
Quiet Boot:	[Enabled]				
Power on display:	[Auto-Selected]				
LCD Display stretch:	[Enabled]				
System Memory:	640 KB				
Extended Memory:	113664 KB				
BIOS Ver.:	V1.00				
F1 Help	↑↓ Select Item	F5/F6 Change Values	F9 Setup Defaults		
Esc Exit	←→ Select Menu	Enter Select > Sub-Menu	F10 Save and Exit		

Navigating the BIOS Utility

There are six menu options: Main, System Device, Security, Others, Boot, and Exit.

Follow these instructions:

- To choose a menu, use the cursor left/right keys (**←** **→**).
- To choose a parameter, use the cursor up/down keys (**↑** **↓**).
- To change the value of a parameter, press **F5** or **F6**.
- A plus sign (+) indicates the item has sub-items. Press **ENTER** to expand this item.
- Press **ESC** while you are in any of the menu options to go to the Exit menu.
- In any menu, you can load default settings by pressing **F9**. You can also press **F10** to save any changes made and exit the BIOS Setup Utility.

NOTE: You can change the value of a parameter if it is enclosed in square brackets. Navigation keys for a particular menu are shown on the bottom of the screen. Help for parameters are found in the Item Specific Help part of the screen. Read this carefully when making changes to parameter values.

Main

The Main screen displays a summary of your computer hardware information, and also includes basic setup parameters.

Main	System Devices	Security	Others	Boot	Exit
					Item Specific Help
System Time:	[11:21:00]				
System Date:	[09/11/2001]				
Floppy Drive:	1.44MB, 3½"				
Hard Disk:	IBM-DJSA-220-(PM)				
Quiet Boot:	[Enabled]				
Power on display:	[Auto-Selected]				
LCD Display stretch:	[Enabled]				
System Memory:	640 KB				
Extended Memory:	113664 KB				
BIOS Ver.:	V1.00				
F1 Help	↑↓ Select Item	F5/F6 Change Values	F9 Setup Defaults		
Esc Exit	←→ Select Menu	Enter Select > Sub-Menu	F10 Save and Exit		

NOTE: The screen above is for reference only. Actual values may differ.

The table below describes the parameters in this screen. Settings in **boldface** are the default and suggested parameter settings..

Parameter	Description	Format/Option
System Time	Sets the system time.	Format: HH:MM:SS (hour:minute:second)System Time
System Date	Sets the system date.	Format MM/DD/YYYY (month/day/year) System Date
Floppy Drive	Shows floppy drive type information.	
Hard Disk	Shows the hard disk model.	
Quiet Boot	Determines the way the system boots up. Shows the high-capacity disc drive installed.	Options: Enabled or Disabled
Power on display	Determines the display device on startup.	Option: Auto-Selected or Simultaneous
LCD Display stretch	Specifies whether or not to expand the image to fill the screen	Option: Enabled or Disabled
System Memory	Shows the amount of system memory.	
Extended Memory	Shows the amount of extended memory	
BIOS Ver.Product Name	Shows the system BIOS version.	

The items in this screen are important and vital information about your computer. If you experience computer problems and need to contact technical support, this data helps our service personnel know more about your computer.

NOTE: Main memory = system memory + extended memory

System Devices

The System Devices screen contains parameters involving your hardware devices.

Main	System Devices	Security	Others	Boot	Exit
					Item Specific Help
Pointing Device:		[Simultaneous]			
Ext. Keyboard "Fn":		[Enabled]			
IDE Controller:		[Both]			
FDD Controller:		[Enabled]			
Parallel Port:		[Enabled]			
Interrupt:		[IRQ 7]			
Mode:		[ECP]			
Base I/O address:		[378]			
DMA channel:		[DMA 3]			
VGA Frame Buffer Size:		[16 Mb]			
F1 Help Esc Exit	↑↓ Select Item ←→ Select Menu	F5/F6 Change Values Enter Select > Sub-Menu	F9 Setup Defaults F10 Save and Exit		

The table below describes the parameters in the screen Settings in **boldface** are the default and suggested parameter settings.

Parameter	Description	Options
Pointing Device	Determines whether or not to disable the internal touchpad of a PS/2 pointing device is connected.	Simultaneous or Auto-Selected
Ext.Keyboard "Fn"	Allows you to simulate an Fn key on an external keyboard by pressing the left b + left a keys	Enabled or Disabled
IDE Controller	Enables or disables the primary or secondary IDE controller or both.	Both , Primary or Disabled
FDD Controller	Enables or disables the floppy drive controller.	Enabled or Disabled
Parallel Port	Enables or disables the parallel port.	Enabled or Disabled
IRQ	Sets the interrupt request of the parallel port.	IRQ 7 or IRQ5
Mode	Sets the operation mode of the parallel port.	ECP , EPP or Bi-directional
Base I/O address	Sets the I/O address of the parallel port. This parameter is enabled only if Mode is set to ECP or Bi-directional.	378 , 278 or 38C
DMA Channel	Sets a DMA channel for the printer to operate in ECP mode. This parameter is enabled only if Mode is set to ECP.	3 or 1
VGA Frame Buffer Size	Specifies the amount of main memory to allocate for VGA.	16Mb , 32Mb or 8Mb

NOTE: VGA takes up a portion of system memory, configurable via the VGA Frame Buffer parameter. For example, if you have 128 MB SDRAM, and you set a VGA Frame Buffer of 16MB, main memory is 112MB.

Security

The Security screen contains parameters that help safeguard and protect your computer from unauthorized use.

Main	System Devices	Security	Others	Boot	Exit
User Password: Clear Set User Password: [Enter] Password on boot: [Disabled]					Item Specific Help
F1 Help Esc Exit	↑↓ Select Item ←→ Select Menu	F5/F6 Change Values Enter Select > Sub-Menu	F9 Setup Defaults F10 Save and Exit		

The table below describes the parameters in this screen. Settings in **boldface** are the default and suggested parameter settings.

Parameter	Description	Option
User Password	Shows the setting of the user password.	Clear or Set
Set User Password	Press Enter to set the user password. When set, this password protects the BIOS Setup Utility from unauthorized access.	
Password on boot	When enabled, the user password protects the computer from unauthorized access during boot up.	Disabled or Enabled

NOTE: When you are prompted to enter a password, you have three tries before the system halts. Don't forget your password. If you forget your password, you may have to return your notebook computer to your dealer to reset it.

Setting a Password

Follow these steps:

1. Use the **↑** and **↓** keys to highlight the Set User Password parameter and press the **ENTER** key. The Set User Password box appears:

Set Password	
Enter new password:	[]
Confirm new password:	[]

-
2. Type a password in the Enter new password field. The password may consist of up to eight alphanumeric characters (A-Z, a-z, 0-9). Retype the password in the Confirm new password field.

IMPORTANT: Be very careful when typing your password because the characters do not appear on the screen.

3. Press **ENTER**.
After setting the password, the computer sets the User Password parameter to “Set”.
4. If desired, you can opt to enable the Password on boot parameter.
5. When you are done, press **F10** to save the changes and exit the BIOS Setup Utility.

Removing a Password

Follow these steps:

1. Use the **↑** and **↓** keys to highlight the Set User Password parameter and press the **ENTER** key. The Set Password box appears:

Set Password		
Enter Current Password	[]
Enter New Password	[]
Confirm New Password	[]

2. Type the current password in the Enter Current Password field and press **ENTER**.
3. Press **ENTER** twice **without** typing anything in the Enter New Password and Confirm New Password fields. The computer then sets the User Password parameter to “Clear”.
4. When you have changed the settings, press **F10** to save the changes and exit the BIOS Setup Utility.

Changing a Password

1. Use the **↑** and **↓** keys to highlight the Set User Password parameter and press the **ENTER** key. The Set Password box appears:

Set Password		
Enter Current Password	[]
Enter New Password	[]
Confirm New Password	[]

2. Type the current password in the Enter Current Password field and press **ENTER**.
3. Type a password in the Enter New Password field. Retype the password in the Confirm New Password field.
4. Press **ENTER**. After setting the password, the computer sets the User Password parameter to “Set”.
5. If desired, you can enable the Password on boot parameter.
6. When you are done, press **F10** to save the changes and exit the BIOS Setup Utility.

Others

The Others screen contains various parameter settings.

Main	System Devices	Security	Others	Boot	Exit
Low Battery Alarm: [Enabled] Panel Close Alarm: [Disabled] System Beep: [Enabled] Sticky Key: [Enabled] Installed O/S: [Win98/Me/2K/XP]					Item Specific Help
F1 Help Esc Exit	↑↓ Select Item ←→ Select Menu	F5/F6 Change Values Enter Select > Sub-Menu	F9 Setup Defaults F10 Save and Exit		

The table below describes the parameters in this screen. Settings in **boldface** are the default and suggested parameter settings.

Parameter	Description	Options
Low Battery Alarm	Determines whether or not the system will alarm when the battery power is low.	Enabled or Disabled
Panel Close Alarm	Determines whether or not the system will alarm when the display cover is closed.	Disabled or Enabled
System Beep	Determines whether or not the system will emit a beep on boot up.	Enabled or Disabled
Sticky Key	Determines whether or not to press Fn together with function keys (F1, F2...etc.) when you need to adjust the system functions, such as brightness. If you set it as enabled, then you do not have to press the function keys with the Fn key. You can press the Fn key once then adjust the function. If you select disabled, you have to press the Fn key with the function keys together	Enabled or Disabled
Installed O/S	Sets the operating system in use. Note: If your O/S is Win NT 4.0, please select the installed O/S as Win NT 4.0. Otherwise, there may be some power management problems occur, because Win NT 4.0 employs APC mode.	Win98/Me/2K/XP or only Win NT4.0

Boot

The Boot screen allows you to set the order in which the system looks for bootable devices on startup.

Main	System Devices	Security	Others	Boot	Exit
+Removable Devices +Hard Drive CD-ROM/DVD Drive Accton Network Boot					Item Specific Help
F1 Help Esc Exit	↑↓ Select Item ←→ Select Menu	F5/F6 Change Values Enter Select > Sub-Menu	F9 Setup Defaults F10 Save and Exit		

The table below describes these devices.

Parameter	Description
Removable Devices	The computer attempts to boot from the removable device (e.g., floppy drive). If unsuccessful, the system goes to the next device in the list.
Hard Drive	The computer attempts to boot from the hard disk. If unsuccessful, the system goes to the next device in the list.
CD-ROM/DVD Drive	The computer attempts to boot from the CD or DVD drive (looks for a bootable CD or DVD.)
Accton Network Boot	The computer attempts to boot from LAN.



NOTE: A plus (+) sign may be shown in front of a device. You can press **ENTER** to “expand” the device and see sub-items in this category.

Exit

The Exit screen contains parameters that help safeguard and protect your computer from unauthorized use.

Main	System Devices	Security	Others	Boot	Exit
Exit Saving Changes Exit Discarding Changes Load Setup Defaults Discard Changes Save Changes					Item Specific Help
F1 Help Esc Exit	↑↓ Select Item ←→ Select Menu	F5/F6 Change Values Enter Execute Command	F9 Setup Defaults F10 Save and Exit		

The table below describes the parameters in this screen.

Parameter	Description
Exit Saving Changes	Saves changes made and exits the BIOS Setup Utility (same as ).
Exit Discarding Changes	Discards changes made and exits the BIOS Setup Utility.
Load Setup Defaults	Loads default settings for all parameters (same as ).
Discard Changes	Discards changes made.
Save Changes	Save changes made.

BIOS Flash Utility

The BIOS flash memory update is required for the following conditions:

- New versions of system programs
- New features or options
- Restore a BIOS when it becomes corrupted.

Use the Phlash utility to update the system BIOS flash ROM.

NOTE: If you do not have a crisis recovery diskette at hand, then you should create a **Crisis Recovery Diskette** before you use the Phlash utility.

NOTE: Do not install memory-related drivers (XMS, EMS, DPMS) when you use the Phlash.

NOTE: Please use the AC adaptor power supply when you run the Phlash utility. If the battery pack does not contain enough power to finish BIOS flash, you may not boot the system because the BIOS is not completely loaded.

Follow the steps below to run the Phlash.

1. Prepare a bootable diskette.
2. Copy the Phlash utilities to the bootable diskette.
3. Then boot the system from the bootable diskette. The Phlash utility has auto-execution function.

System Utility Diskette

This utility diskette is for the Acer TravelMate α 550 notebook machine. You can find the utility in Service CD kit. It provides the following functions:

1. Panel ID Utility
2. Thermal & Fan Utility
3. Mother Board Data Utility

To use this diskette, first boot from this diskette, then a "Microsoft Windows ME Startup Menu" prompt you to choose the testing item. Follow the instructions on screen to proceed.

NOTE: This program contains a readme.txt file. This readme.txt file will introduce each test utility and its functions.

System Diagnostic Diskette

IMPORTANT: ¹The diagnostics program we use for TravelMate α 550 is not exactly the same as PQA (Product Quality Assurance), the diagnostic program we used to employ in other model. The system diagnostic utilities is provided by Acer Headquarters. You can utilize it as a basic diagnostic tool. To get this program, find it in the TravelMate α 550 service CD kit. To better fit local service requirements, your regional office MAY have other diagnostic program. Please contact your regional offices or the responsible personnel/channel to provide you with further technical details.

NOTE: For ASSY Function Test Procedure, please prepare the following items for system components test: PIO loopback, diskette, mouse (PS/2), CD-Disk (Test Program), battery pack, SYS_card (Card Bus)X2, AC-adaptor, keyboard, speaker and feather.

¹ New added description. Please pay attention to it.

Running Diagnostics Program

1. BIOS Re-flash

Insert CD-Disk and floppy disk then boot from floppy disk drive to BIOS re-flash.

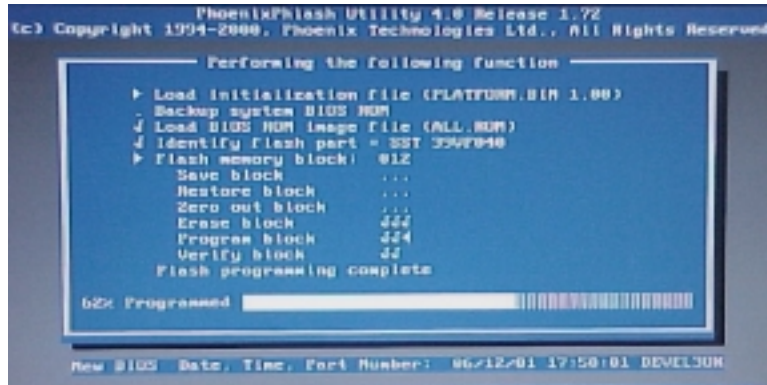

2. Parallel Port Test

Insert PIO loopback of parallel port for test.

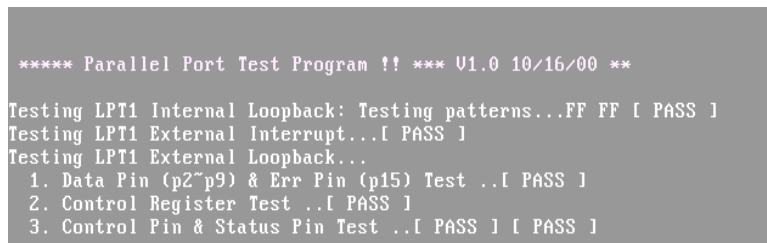

3. RTC, FDD Test

Insert diskette to floppy disk drive for test.

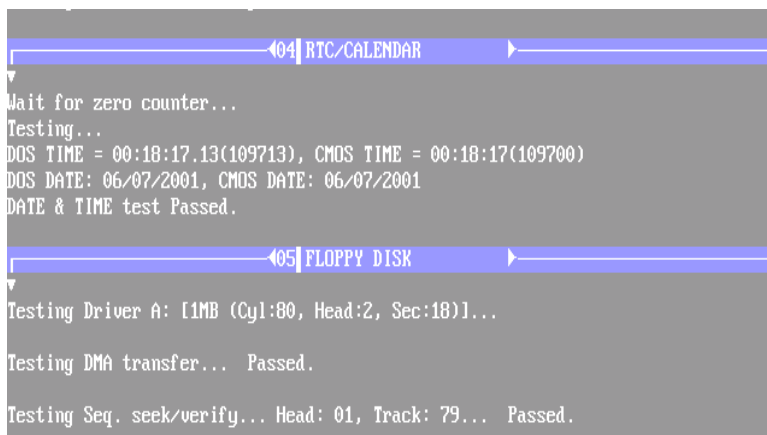

4. Thermal Test

```

Begin Time(mm/dd hh:mm:ss) 6/11 16:58:39
Remote_Temp.=60 Local_Temp.=53 Fan_Voltage.= ff HCT.=0 6/11 16:58:39
Remote_Temp.=60 Local_Temp.=53 Fan_Voltage.= ff HCT.=0 6/11 16:58:40
Remote_Temp.=59 Local_Temp.=53 Fan_Voltage.= ff HCT.=0 6/11 16:58:41
PASS ! PASS !

```

5. CD-ROM Test

First test left channel, if you hear sounds then press **[ENTER]** key to test right channel.

```

LAP:00000(0000:01)06-07-101 COMPAL TSEL/F:CDROM.SCY IN:2 Version: PCBT
<01 COMPACT DISC ROM >
CD ROM Drive D:, MSCDEX ver.: 2.25, Driver name: CDROM1 , Vol.: COMPAL_TEST
Total 264496 sectors(2352 bytes/sector) = 622094592 bytes

Testing for DATA CD:
Testing CD ROM reset function...Passed.
Testing seq. read... sector: 243297( 24)
Testing fun. read... sector: 116361( 23) Passed.

Testing AUDIO CD first track...
Playing track 2, starting at 60:255:21

>> RIGHT CHANNEL <-> >>>>>>

```

If you hear sounds then press “P” key to pass this item.

```

LAP:00000(0000:01)06-07-101 COMPAL TSEL/F:CDROM.SCY IN:2 Version: PCBT
<01 COMPACT DISC ROM >
CD ROM Drive D:, MSCDEX ver.: 2.25, Driver name: CDROM1 , Vol.: COMPAL_TEST
Total 264496 sectors(2352 bytes/sector) = 622094592 bytes

Testing for DATA CD:
Testing CD ROM reset function...Passed.
Testing seq. read... sector: 243297( 24)
Testing fun. read... sector: 116361( 23) Passed.

Testing AUDIO CD first track...
Playing track 2, starting at 60:255:21

After listen -- [Passed] [Failed]: P

```

6. Batter Charge Test

Plug the AC adapter to the system for test.

```
ONLY FOR 30M3 SERIES BATTERY TEST. V1.0 2001/04/10
```

```
ManufactureDate: 1980/00/18                      Serial Number : 18
Design Capacity Value = 3900mAH
Battery fullcharge Capacity = 3911 mA
Design Voltage Value = 14800mv [Li_Ion]
Remaincharge capacity testing
Available Percentage Value = 3907mAH [99.9%]
Battery Supplier = Panas
Charge ->
Remaincharge capacity testing > 95.0% ... charge abort
```

7. Video mode Test

Check the RGB video mode display quality.

8. T/P Mouse Test

```
** FATMOUSE test version 1.08 **
Please check for mouse action & status
Test end coordinate X=0 Y=0 and push left and right buttons
```

Coordinate		Button	
X	Y	Left	Right
280	152	0	0

9. FAN Test

Check if the fan has turned on with feathers.

```
FAN-ON
Press any key to continue . . .
```

10. LAN Test

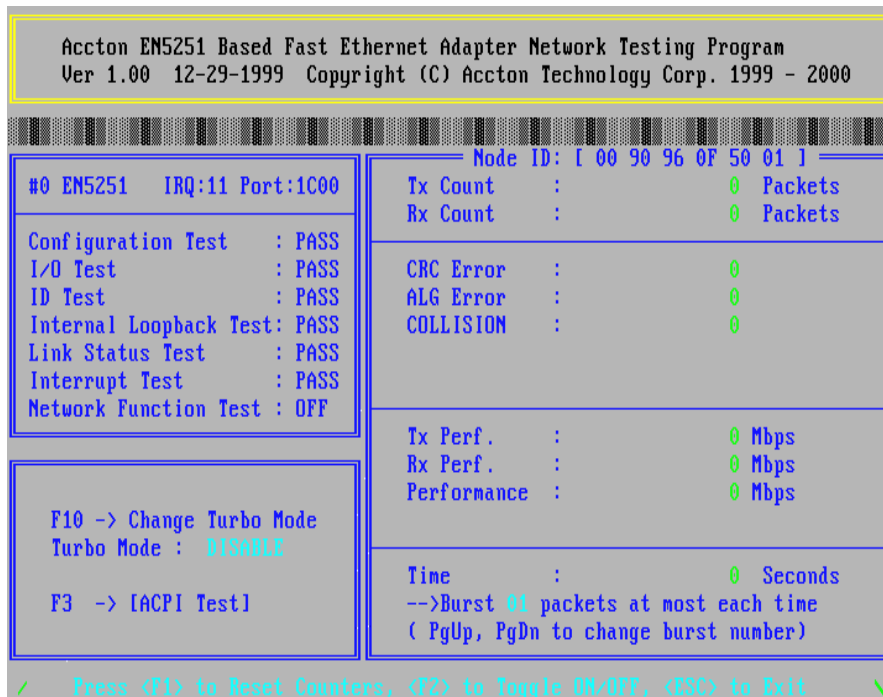

11. Keyboard Test

Press all keys according to this order--from left to right and from up to down to test each key's function. If pass then press **CTRL** + Break to continue the next test.



12. 32bit Syscard Test

Insert two pieces of Syscard (Card bus) into PCMCIA slots for test. Check travel card if found error code on the card then record to SFIS and travel card else affix QC seal on the travel card.

Machine Disassembly and Replacement

This chapter contains step-by-step procedures on how to disassemble the notebook computer for maintenance and troubleshooting.

To disassemble the computer, you need the following tools:

- Wrist grounding strap and conductive mat for preventing electrostatic discharge
- plastic screw driver
- FPC fixture
- Tweezers
- Flat-bladed screw driver or plastic stick
- hex screw driver
- plastic tool that can prize stripe cover

NOTE: The screws for the different components vary in size. During the disassembly process, group the screws with the corresponding components to avoid mismatch when putting back the components. When you remove the stripe cover, please be careful not to scrape the cover.

General Information

Before You Begin

Before proceeding with the disassembly procedure, make sure that you do the following:

1. Turn off the power to the system and all peripherals.
2. Unplug the AC adapter and all power and signal cables from the system.
3. Remove the battery pack.

NOTE: TravelMate α 550 uses mylar or tape to fasten the FFC/FPC/connectors, you may need to tear the tape or mylar before you disconnect different FFC/FPC/connectors.

Disassembly Procedure Flowchart

The flowchart on the succeeding page gives you a graphic representation on the entire disassembly sequence and instructs you on the components that need to be removed during servicing. For example, if you want to remove the system board, you must first remove the keyboard, then disassemble the inside assembly frame in that order.

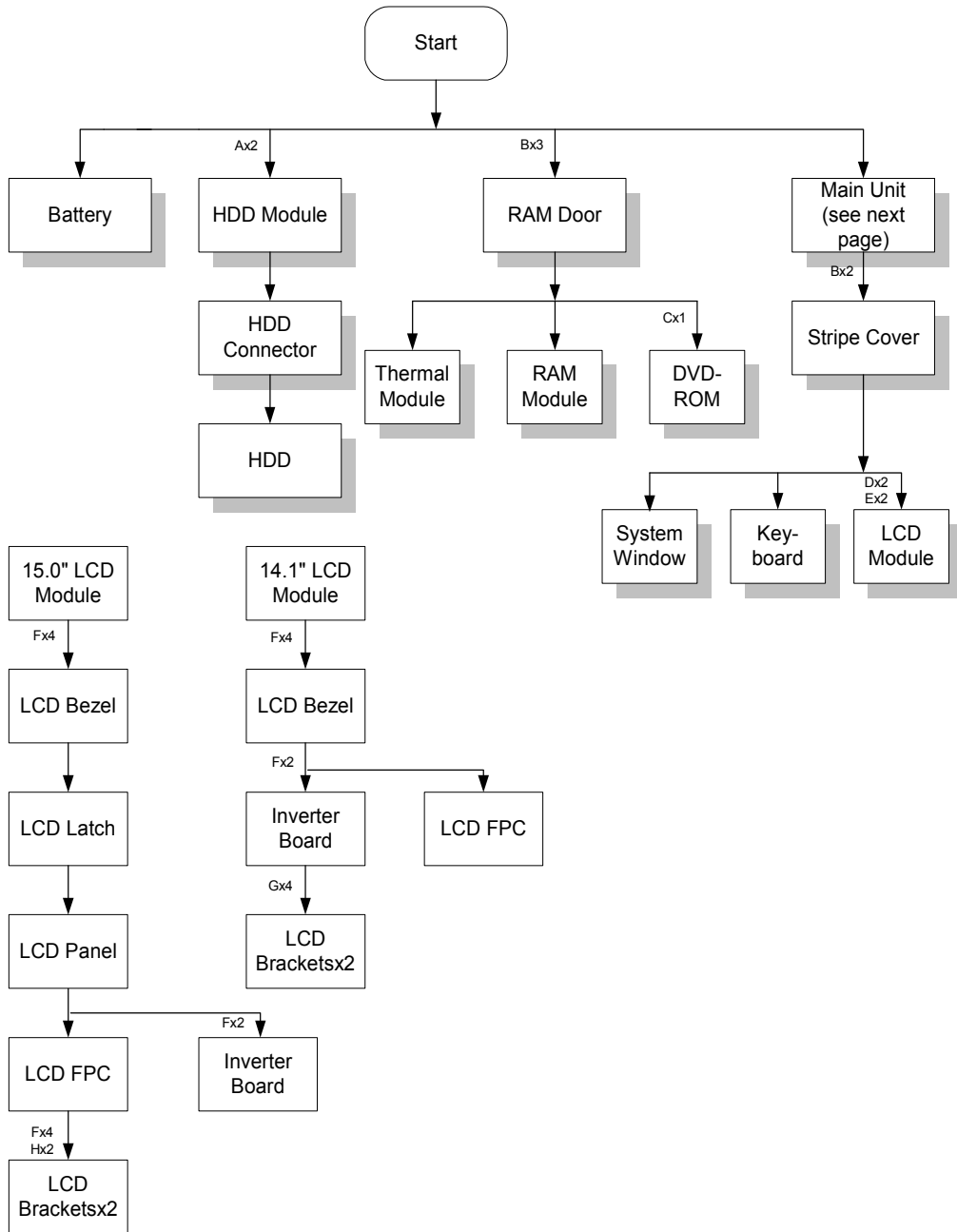

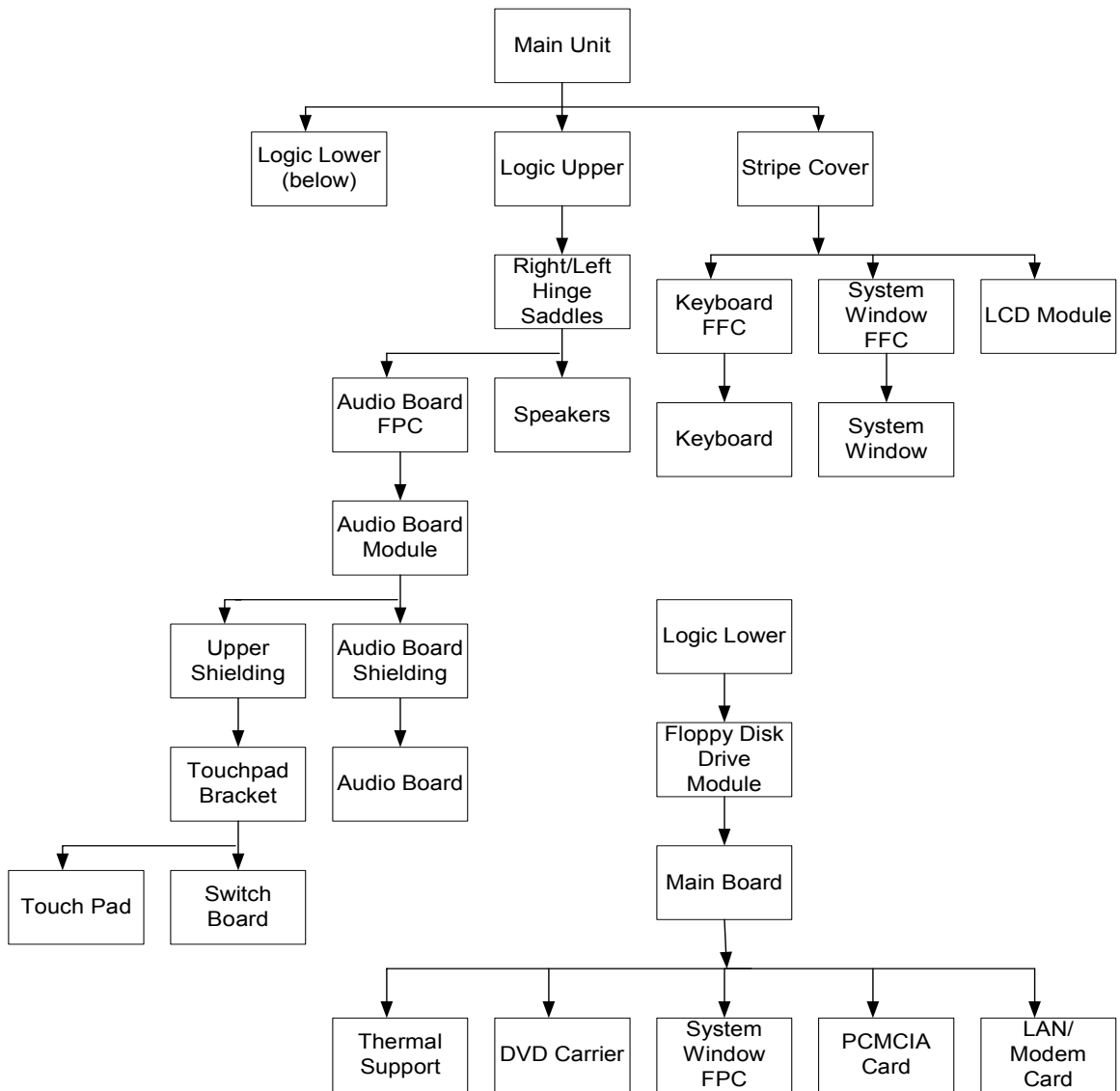

Screw List

Item	Description
A	Screw M2.5 X 0.45+8FD-ZK
B	Screw M2.5 X 4.5P+3FP-ZK
C	Screw M2.5 X 0.45P+4FP-NI(NL)
D	Screw M2.5 X 0.45+8FP-NI(NL)
E	Screw M2.5 X 0.45+18FP-ZK(NL)
F	Screw M2.5 X 0.45P+5K-2K(NL)
G	Screw M2.0 X 0.4P+2.3(NL)
H	Screw M2.0 X 0.4P+3FP-ZK(NL)

Removing the Battery Pack

1. Press the battery lock.
2. Push the release button forward then remove the battery pack.



Removing the HDD Module/Thermal Module/CPU and DVD-ROM

1. Remove the two screws of the HDD module, then remove the HDD module from the logic lower.



2. Unscrew the three screws on the ram door. Then remove the ram door. Next, disconnect the thermal connector. Then, remove the four screws on the thermal module and remove the thermal module.

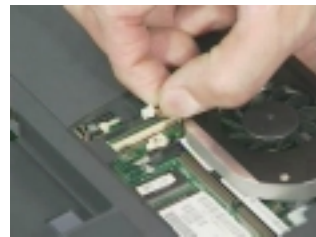

3. Use the CPU fixture and the flat-bladed screw driver to remove the CPU.



4. Remove the screw on the DVD-ROM bracket and push the DVD-ROM bracket. Then remove this module.

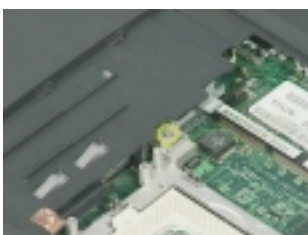

Removing the LCD Module/the Keyboard and the System Window

Removing the LCD Module

1. Remove the two (one on each side) screws holding the LCD stripe cover. Then prize the stripe cover with the plastic flat-bladed tool.
2. Unscrew the four screws (two on each side) holding the LCD module to the main unit. Then, Disconnect LCD FPC and remove the LCD module.

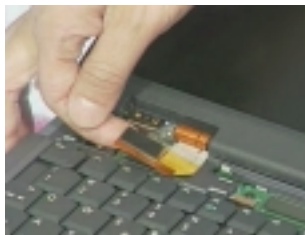

Removing the keyboard

1. Remove the four (two on each side) screws holding the keyboard.
2. Disconnect the keyboard connector. After disconnect the keyboard connector then remove the keyboard.

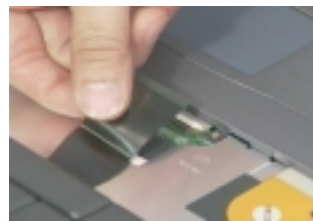
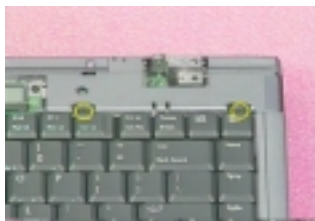

Removing the system window

1. Disconnect system window FPC.
2. Unscrew the two screws holding the system window. Then remove the system window.

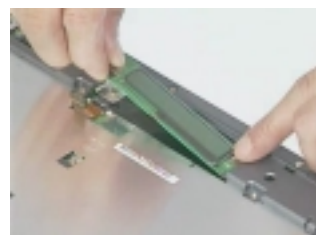

Disassembling the Main Unit

Separate the main unit into the logic upper and the logic lower assembly

1. Remove the four screw locks from I/O port.
2. Then remove the two screws as the picture shows.

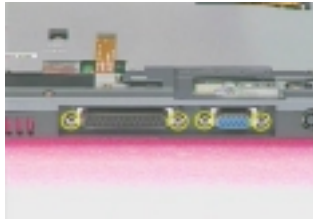

3. Remove the eight screws on the logic lower.
4. Disconnect switch board FPC.
5. Remove the logic upper from the main unit.

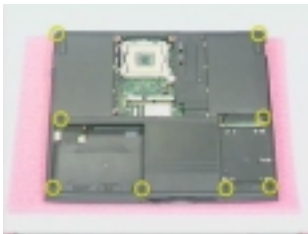

Disassembling the logic upper

1. Unscrew the five screws holding the right and the left hinge saddles.
2. Remove the right and the left hinge saddles.



3. Tear the mylar from logic upper assembly.
4. Remove the two screws holding the audio board.
5. Remove the audio board shielding.
6. Disconnect audio board FPC

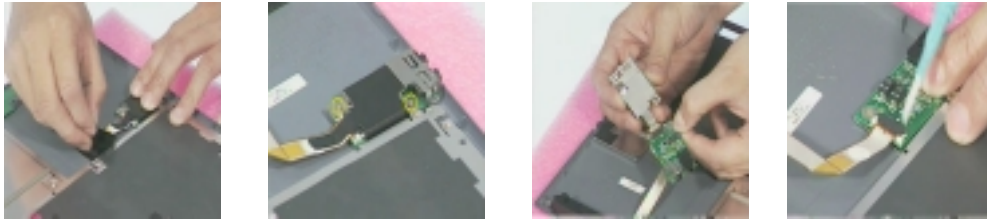

7. Remove the four screws holding the upper shielding.
8. Release the two locks.
9. Then remove the upper shielding from the logic upper assembly.

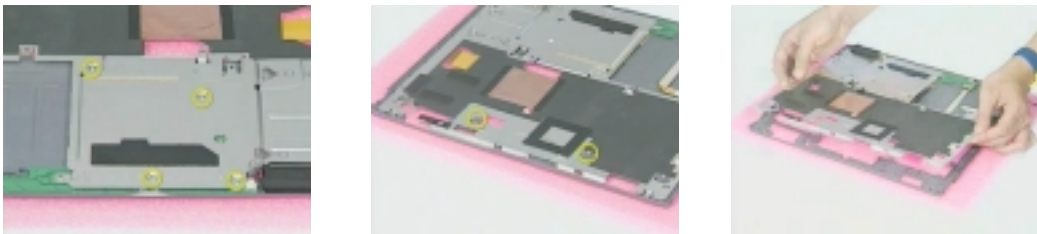

10. Disconnect the two speakers wires (one on each side).
11. Remove the two screws holding the speakers on each side. Then remove the speakers.

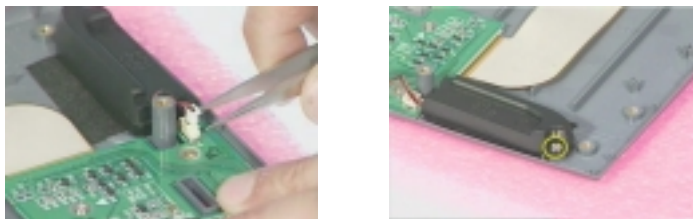

12. Disconnect touchpad FFC from the touch pad.
13. Remove the touchpad bracket as the pictures show. Please see the yellow arrows.



14. Remove the touchpad.
15. Disconnect the touchpad FFC and then remove it.



16. Remove the two screws that hold switchboard on the logic upper. One is on the right; the other is on the left.
17. Disconnect the audio board FPC from the switchboard.
18. Disconnect the switchboard FPC.
19. These are complete steps for logic upper disassembly.

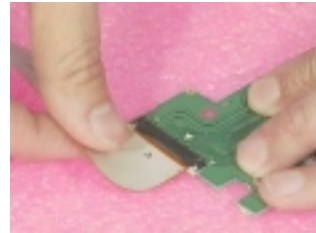

Disassembling the logic lower

1. Remove the two screws holding the floppy disk drive bracket.
2. Disconnect the floppy disk drive FFC.
3. Disconnect the system window FPC.



4. Remove the two screws holding the mainboard.
5. Then remove the mainboard carefully.



-
6. Unscrew the three screws that holds the DVD-ROM bracket.
 7. Remove the DVD-ROM bracket.

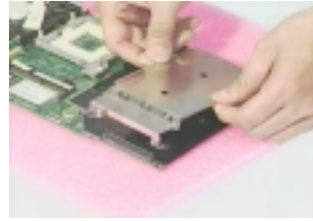

8. Remove the four screws holding the thermal support.
9. Remove the thermal support.

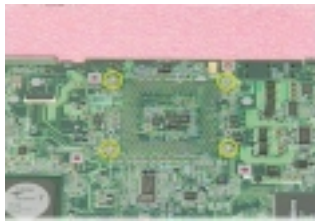

10. Tear the tape on LAN/Modem card.
11. Disconnect the LAN/Modem card from mini PCD.
12. Disconnect LAN/Modem wires from the LAN/Modem card.
13. These are complete steps for logic lower disassembly.

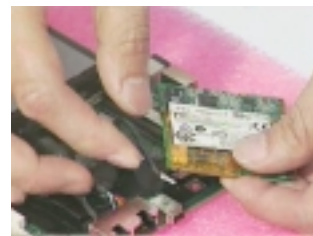

Disassembling the LCD Module-15 Inch

1. First remove the two screw pads then remove the two screws.
2. Disattach the LCD bezel carefully. Please note that you have to push forward at the two indentations.
3. Unscrew the two screws then remove the latch.

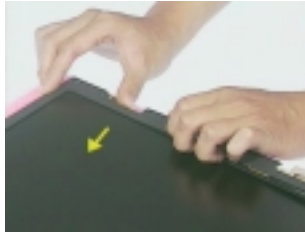

4. Unscrew the two screws on the inverter board.
5. Remove the four screws holding the right and left hinges. There are two screws on each side.
6. Remove the right and the left hinge.

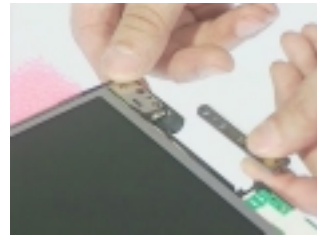

7. Detach the EMI tape and then remove LCD from the cover carefully.
8. Disconnect the inverter board from LCD FPC.
9. Disconnect the LCD power connector.

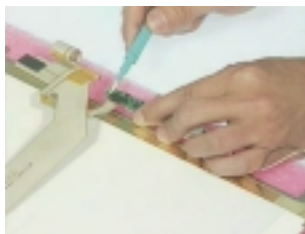

10. Disconnect the LCD FPC.
11. Unscrew the eight screws on the brackets. There are four on each side then remove the brackets.

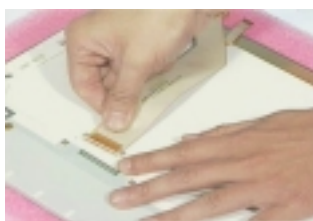

Disassembling the External Modules

Disassembling the HDD Module

1. Remove the four screws on HDD carrier.
2. Remove the hard disk drive from the carrier.
3. Disconnect the hard disk connector.

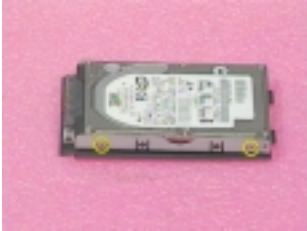

Disassembling the Floppy Disk Drive Module

1. Disconnect the floppy disk drive FFC.
2. Unscrew the two screws holding the bracket.
3. Unscrew the screw holding the bracket.

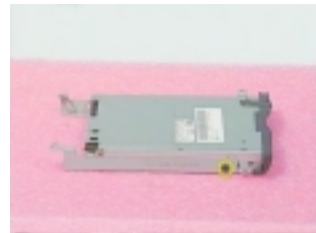

4. Remove the right and the left brackets.
5. Press the FDD latch with the fixture and remove the FDD panel.



Disassembling the DVD-ROM Module

1. Unscrew the two screws holding the support plate.
2. Then remove the support plate.



Troubleshooting

Use the following procedure as a guide for computer problems.

NOTE: The diagnostic tests are intended to test this model. Non-Acer products, prototype cards, or modified options can give false errors and invalid system responses.

1. Obtain the failing symptoms in as much detail as possible.
2. Verify the symptoms by attempting to re-create the failure by running the diagnostic test or by repeating the same operation.
3. If any problem occurs, you can perform visual inspection before you follow this chapter's instructions. You can check the following:
 - power cords are properly connected and secured;
 - there are no obvious shorts or opens;
 - there are no obviously burned or heated components;
 - all components appear normal.
4. Use the following table with the verified symptom to determine which page to go to.

Symptoms (Verified)	Go To
Power failure. (The power indicator does not go on or stay on.)	"Power System Check" on page 67.
POST does not complete. No beep or error codes are indicated.	"Power-On Self-Test (POST) Error Message" on page 69 "Undetermined Problems" on page 77
POST detects an error and displayed messages on screen.	"Error Message List" on page 70
The diagnostic test detected an error and displayed a FRU code.	"System Diagnostic Diskette" on page 45
Other symptoms (i.e. LCD display problems or others).	"Power-On Self-Test (POST) Error Message" on page 69
Symptoms cannot be re-created (intermittent problems).	Use the customer-reported symptoms and go to "Power-On Self-Test (POST) Error Message" on page 69 "Intermittent Problems" on page 76 "Undetermined Problems" on page 77

System Check Procedures

External Diskette Drive Check

Do the following to isolate the problem to a controller, driver, or diskette. A write-enabled, diagnostic diskette is required.

NOTE: Make sure that the diskette does not have more than one label attached to it. Multiple labels can cause damage to the drive or cause the drive to fail.

Do the following to select the test device. See “System Diagnostic Diskette” on page 45 for details.

1. Boot from the diagnostics diskette and start the diagnostics program (see “System Diagnostic Diskette” on page 45).
2. See if FDD Test is passed as the program runs to FDD Test.
3. Follow the instructions in the message window.

If an error occurs with the internal diskette drive, reconnect the diskette connector on the system board.

If the error still remains:

1. Reconnect the external diskette drive/DVD-ROM module.
2. Replace the external diskette drive/CD-ROM module.
3. Replace the main board.

External CD-ROM Drive Check

Do the following to isolate the problem to a controller, drive, or CD-ROM. Make sure that the CD-ROM does not have any label attached to it. The label can cause damage to the drive or can cause the drive to fail.

Do the following to select the test device:

1. Boot from the diagnostics diskette and start the diagnostics program (refer to “System Diagnostic Diskette” on page 45).
2. See if CD-ROM Test is passed when the program runs to CD-ROM Test.
3. Follow the instructions in the message window.

If an error occurs, reconnect the connector on the System board. If the error still remains:

1. Reconnect the external diskette drive/CD-ROM module.
2. Replace the external diskette drive/CD-ROM module.
3. Replace the main board.

Keyboard or Auxiliary Input Device Check

Remove the external keyboard if the internal keyboard is to be tested.

If the internal keyboard does not work or an unexpected character appears, make sure that the flexible cable extending from the keyboard is correctly seated in the connector on the system board.

If the keyboard cable connection is correct, run the Keyboard Test. See “System Diagnostic Diskette” on page 45 for details.

If the tests detect a keyboard problem, do the following one at a time to correct the problem. Do not replace a non-defective FRU:

1. Reconnect the keyboard cables.
2. Replace the keyboard.
3. Replace the main board.

The following auxiliary input devices are supported by this computer:

- Numeric keypad
- External keyboard

If any of these devices do not work, reconnect the cable connector and repeat the failing operation.

Memory Check

Memory errors might stop system operations, show error messages on the screen, or hang the system.

1. Boot from the diagnostics diskette and start the doagmpstotics program (please refer to “System Diagnostic Diskette” on page 45).
2. Go to the diagnostic memory in the test items.
3. Press F2 in the test items.
4. Follow the instructions in the message window.

NOTE: Make sure that the DIMM is fully installed into the connector. A loose connection can cause an error.

Power System Check

To verify the symptom of the problem, power on the computer using each of the following power sources:

1. Remove the battery pack.
2. Connect the power adapter and check that power is supplied.
3. Disconnect the power adapter and install the charged battery pack; then check that power is supplied by the battery pack.

If you suspect a power problem, see the appropriate power supply check in the following list:

- “Check the Battery Pack” on page 68
- “Check the Battery Pack” on page 68

Check the Battery Pack

To check the battery pack, do the following:

From Software:

1. Check out the Power Management in control Panel
2. In Power Meter, confirm that if the parameters shown in the screen for Current Power Source and Total Battery Power Remaining are correct.
3. Repeat the steps 1 and 2, for both battery and adapter.
4. This helps you identify first the problem is on recharging or discharging.

From Hardware:

1. Power off the computer.
2. Remove the battery pack and measure the voltage between battery terminals 1(+) and 6(ground). See the following figure
3. If the voltage is still less than 7.5 Vdc after recharging, replace the battery.

To check the battery charge operation, use a discharged battery pack or a battery pack that has less than 50% of the total power remaining when installed in the computer.

If the battery status indicator does not light up, remove the battery pack and let it return to room temperature. Re-install the battery pack.

If the charge indicator still does not light up, replace the battery pack. If the charge indicator still does not light up, replace the DC/DC charger board.

Touchpad Check

If the touchpad doesn't work, do the following actions one at a time to correct the problem. Do not replace a non-defective FRU:

1. After rebooting, run Tracking Pad PS2 Mode Driver. For example, run Syn touch driver.
2. Run utility with the PS/2 mouse function and check if the mouse is working.
3. If the the PS/2 mouse does not work, then check if the main board to switch board FPC is connected O.K.
4. If the main board to switch board FPC is connected well, then check if the FCC on touch pad PCB connects properly.
5. If the FFC on touch pad PCB connects properly, then check if LS851 JP1 Pin6=5V are pulese. If yes, then replace switch board. If no, then go to next step.
6. Replace touch pad PCB.
7. If the touch pad still does not work, then replace FPC on Track Pad PCB.

After you use the touchpad, the pointer drifts on the screen for a short time. This self-acting pointer movement can occur when a slight, steady pressure is applied to the touchpad pointer. This symptom is not a hardware problem. No service actions are necessary if the pointer movement stops in a short period of time.

Power-On Self-Test (POST) Error Message

The POST error message index lists the error message and their possible causes. The most likely cause is listed first.

NOTE: Perform the FRU replacement or actions in the sequence shown in FRU/Action column, if the FRU replacement does not solve the problem, put the original part back in the computer. Do not replace a non-defective FRU.

This index can also help you determine the next possible FRU to be replaced when servicing a computer.

If the symptom is not listed, see “Undetermined Problems” on page 77.

The following lists the error messages that the BIOS displays on the screen and the error symptoms classified by function.

NOTE: Most of the error messages occur during POST. Some of them display information about a hardware device, e.g., the amount of memory installed. Others may indicate a problem with a device, such as the way it has been configured.

NOTE: If the system fails after you make changes in the BIOS Setup Utility menus, reset the computer, enter Setup and install Setup defaults or correct the error.

Index of Error Messages

Error Code List

Error Codes	Error Messages
006	Equipment Configuration Error
010	Equipment Configuration Error
070	Real Time Clock Error 1
071	CMOS Battery Bad 4
072	CMOS Checksum Error 1
080	Battery Is Critical Low 1
110	Incorrect password specified, system halted 1

Error Message List

Error Messages	FRU/Action in Sequence
0200 Failure Fixed Disk	Hard disk error detected. Check to see if fixed disk is attached properly. Enter the BIOS Setup Utility and verify the hard disk is detected.
0211 Keyboard error	see "Keyboard or Auxiliary Input Device Check" on page 67.
0212 Keyboard Controller Failed	see "Keyboard or Auxiliary Input Device Check" on page 67. May require replacing the keyboard controller.
0213 Keyboard locked - Unlock key switch	Unlock the system to proceed.
0220 Monitor type does not match CMOS - Run SETUP	Display device mismatch. Enter the BIOS Setup Utility and verify the parameters (try loading the default settings); then save and restart the computer.
0230 Shadow RAM Failed at offset: nnnn	Shadow RAM test failed System board
0231 System RAM Failed at offset: nnnn	System RAM test failed System board
0232 Extended RAM Failed at offset: nnnn	Extended RAM test failed System board
0250 System battery is dead - Replace and run SETUP	CMOS clock battery needs to be replaced. Replace the battery and run BIOS Setup Utility to reconfigure system time, then reboot system.
0251 System CMOS checksum bad - Default configuration used	CMOS has been corrupted or modified incorrectly. Run BIOS Setup Utility and verify the parameters; then save and restart the computer. Check the system battery.
0260 System timer error	System timer test failed, and the system board needs to be repaired. Run BIOS Setup Utility to reconfigure system time, then reboot system. System board
0270 Real time clock error	RTC battery Run BIOS Setup Utility to reconfigure system time, then reboot system. System board
0280 Previous boot incomplete - Default configuration used	Previous boot-up was not completed successfully. Enter the BIOS Setup Utility and verify the parameters (try loading the default settings); then save and restart the computer. RTC battery System board

Error Message List

Error Messages	FRU/Action in Sequence
0281 Memory size found by POST differed from CMOS	Run "Load Setup Defaults" in BIOS Setup Utility. System board
02B0 Diskette drive A/B error	Drive A: or B: is present but fails the BIOS POST diskette tests. Check the drive is defined with the proper diskette type in BIOS Setup Utility Check if the diskette drive is attached correctly. See "External Diskette Drive Check" on page 66.
02B2 Incorrect Drive A type - run SETUP	Type of floppy drive A: not correctly identified in Setup. System board
02D0 System cache error - Cache disabled	RAM cache failed and BIOS disabled the cache. On older boards, check the cache jumpers. You may have to replace the cache. System board
02F0 CPU ID	CPU socket number for Multi-Processor error. System board
02F4 EISA CMOS not writeable	System unable to write to EISA CMOS. System board
02F5 DMA Test Failed	System unable to write to DMA (Direct Memory Access) registers. System board
02F6 Software NMI Failed	System unable to generate software NMI (Non-Maskable Interrupt). System board
02F7 Fail-Safe Timer NMI Failed	Fail-Safe Timer takes too long. System board
<i>device</i> Address Conflict	Specific device has an address conflict. Enter the BIOS Setup Utility and verify the parameters (try loading the default settings); then save and restart the computer. RTC battery System board
Failing Bits: nnnn	Memory test failed. DIMM BIOS ROM System board
Invalid System Configuration Data	Error with NVRAM (CMOS) data. Enter the BIOS Setup Utility and verify the parameters (try loading the default settings); then save and restart your computer. System board
I/O device IRQ conflict	I/O device has IRQ (Interrupt Request) conflict. Enter the BIOS Setup Utility and verify the parameters (try loading the default settings); then save and restart the computer. RTC battery System board
Operating system not found	Operating system cannot be found on the boot device. Enter the BIOS Setup Utility and verify the parameters (try loading the default settings); then save and restart the computer. Recover hard disk. Reinstall the operating system.
Parity Check 1 nnnn	Parity error found on system bus. BIOS attempts to locate the address and display it on the screen. If it cannot locate the address, it displays.
Parity Check 2 nnnn	Parity error found on I/O bus. BIOS attempts to locate the address and display it on the screen. If it cannot locate the address, it displays .

Error Message List

No beep Error Messages	FRU/Action in Sequence
No beep, power-on indicator turns off and LCD is blank.	Power source (battery pack and power adapter). See "Power System Check" on page 67. Ensure every connector is connected tightly and correctly. Reconnect the DIMM. LED board. System board.
No beep, power-on indicator turns on and LCD is blank.	Power source (battery pack and power adapter). See "Power System Check" on page 67. Reconnect the LCD connector Hard disk drive LCD inverter ID LCD cable LCD Inverter LCD System board
No beep, power-on indicator turns on and LCD is blank. But you can see POST on an external CRT.	Reconnect the LCD connectors. LCD inverter ID LCD cable LCD inverter LCD System board
No beep, power-on indicator turns on and a blinking cursor shown on LCD during POST.	Ensure every connector is connected tightly and correctly. System board
No beep during POST but system runs correctly.	Speaker System board

Index of Symptom-to-FRU Error Message

LCD-Related Symptoms

Symptom / Error	Action in Sequence
LCD backlight doesn't work LCD is too dark LCD brightness cannot be adjusted LCD contrast cannot be adjusted	Enter BIOS Utility to execute "Load Setup Defaults" on Exit screen, then reboot system. Reconnect the LCD connectors. Keyboard (if contrast and brightness function key doesn't work). LCD inverter ID LCD cable LCD inverter LCD System board
Unreadable LCD screen Missing pels in characters Abnormal screen Wrong color displayed	Reconnect the LCD connector LCD inverter ID LCD cable LCD inverter LCD System board
LCD has extra horizontal or vertical lines displayed.	LCD inverter ID LCD inverter LCD cable LCD System board

Indicator-Related Symptoms

Symptom / Error	Action in Sequence
Indicator incorrectly remains off or on, but system runs correctly	Reconnect the inverter board Inverter board System board

Power-Related Symptoms

Symptom / Error	Action in Sequence
Power shuts down during operation	Power source (battery pack and power adapter). See "Power System Check" on page 67. Battery pack Power adapter Hard drive & battery connection board System board
The system doesn't power-on.	Power source (battery pack and power adapter). See "Power System Check" on page 67. Battery pack Power adapter Hard drive & battery connection board System board
The system doesn't power-off.	Power source (battery pack and power adapter). See "Power System Check" on page 67. Hold and press the power switch for more than 4 seconds. System board
Battery can't be charged	See "Check the Battery Pack" on page 68. Battery pack System board

PCMCIA-Related Symptoms

Symptom / Error	Action in Sequence
System cannot detect the PC Card (PCMCIA)	PCMCIA slot assembly System board
PCMCIA slot pin is damaged.	PCMCIA slot assembly

Memory-Related Symptoms

Symptom / Error	Action in Sequence
Memory count (size) appears different from actual size.	DIMM System board

Speaker-Related Symptoms

Symptom / Error	Action in Sequence
In Windows, multimedia programs, no sound comes from the computer.	Audio driver Speaker System board
Internal speakers make noise or emit no sound.	Speaker System board

Power Management-Related Symptoms

Symptom / Error	Action in Sequence
The system will not enter hibernation	Keyboard (if control is from the keyboard) Hard disk drive System board
The system doesn't enter hibernation mode and four short beeps every minute.	Press Fn+F4 and see if the computer enters hibernation mode. Touchpad Keyboard Hard disk connection board Hard disk drive System board
The system doesn't enter standby mode after closing the LCD	LCD cover switch System board
The system doesn't resume from hibernation mode.	Hard disk connection board Hard disk drive System board
The system doesn't resume from standby mode after opening the LCD.	LCD cover switch System board
Battery fuel gauge in Windows doesn't go higher than 90%.	Remove battery pack and let it cool for 2 hours. Refresh battery (continue use battery until power off, then charge battery). Battery pack System board
System hangs intermittently.	See "Thermal & Fan Utility" on page 45. Reconnect hard disk/CD-ROM drives. Hard disk connection board System board

Peripheral-Related Symptoms

Symptom / Error	Action in Sequence
System configuration does not match the installed devices.	Enter BIOS Setup Utility to execute "Load Setup defaults", then reboot system. Reconnect hard disk/CD-ROM/diskette drives.
External display does not work correctly.	Press Fn+F5, LCD/CRT/Both display switching See "System Diagnostic Diskette" on page 45. System board
USB does not work correctly	See "System Diagnostic Diskette" on page 45 System board
Print problems.	Ensure the "Parallel Port" in the "System Devices" of BIOS Setup Utility is set to Enabled. Onboard Devices Configuration Run printer self-test. Printer driver Printer cable Printer System Board

Keyboard/Touchpad-Related Symptoms

Symptom / Error	Action in Sequence
Keyboard (one or more keys) does not work.	Reconnect the keyboard cable. Keyboard System board
Touchpad does not work.	Reconnect touchpad cable. Touchpad board System board

Modem-Related Symptoms

Symptom / Error	Action in Sequence
Internal modem does not work correctly.	See "System Diagnostic Diskette" on page 45. Modem phone port modem combo board System board

NOTE: If you cannot find a symptom or an error in this list and the problem remains, see "Undetermined Problems" on page 77.

Intermittent Problems

Intermittent system hang problems can be caused by a variety of reasons that have nothing to do with a hardware defect, such as: cosmic radiation, electrostatic discharge, or software errors. FRU replacement should be considered only when a recurring problem exists.

When analyzing an intermittent problem, do the following:

1. Run the advanced diagnostic test for the system board in loop mode at least 10 times.
2. If no error is detected, do not replace any FRU.
3. If any error is detected, replace the FRU. Rerun the test to verify that there are no more errors.

Undetermined Problems

The diagnostic problems does not identify which adapter or device failed, which installed devices are incorrect, whether a short circuit is suspected, or whether the system is inoperative.

Follow these procedures to isolate the failing FRU (do not isolate non-defective FRU).

NOTE: Verify that all attached devices are supported by the computer.

NOTE: Verify that the power supply being used at the time of the failure is operating correctly. (See “Power System Check” on page 67):

1. Power-off the computer.
2. Visually check them for damage. If any problems are found, replace the FRU.
3. Remove or disconnect all of the following devices:
 - Non-Acer devices
 - Printer, mouse, and other external devices
 - Battery pack
 - Hard disk drive
 - DIMM
 - CD-ROM/Diskette drive Module
 - PC Cards
4. Power-on the computer.
5. Determine if the problem has changed.
6. If the problem does not recur, reconnect the removed devices one at a time until you find the failing FRU.
7. If the problem remains, replace the following FRU one at a time. Do not replace a non-defective FRU:
 - System board
 - LCD assembly

Index of AFlash BIOS Error Message

Error Message	Action in Sequence
Hardware Error	See "System Diagnostic Diskette" on page 45
VPD Checksum Error	Reboot the system and then retest with this diskette.
BIOS Update Program Error	Turn off the power and restart the system.
System Error	Make sure this AFlash BIOS diskette for this model.
Without AC adapter	make sure to connect AC adapter
Battery Low	make sure to install a highly charged battery, and reboot system.

Index of PQA Diagnostic Error Code, Message

Error Code	Message	Action in Sequence
16XXX	Backup battery error	Backup battery
01XXX	CPU or main board error	Reload BIOS default setting. System board
02XXX	Memory error	DIMM System board
03XXX	Keyboard error	Reset Keyboard Keyboard System board
04XXX	Video error	System board
05XXX	Parallel Port error	System board
06XXX	Serial port or main board error	System board
07XXX	Diskette drive error	Diskette drive System board
08XXX	Hard disk error	Reload BIOS default setting Hard disk System board
09XXX	CD-ROM error	Reset CD-ROM cable CD-ROM drive System board
10XXX	Co-processor error	System board
11XXX	Pointing device error	Reset Keyboard Keyboard System board
12XXX	Cache test error	System board

Jumper and Connector Locations

Top View

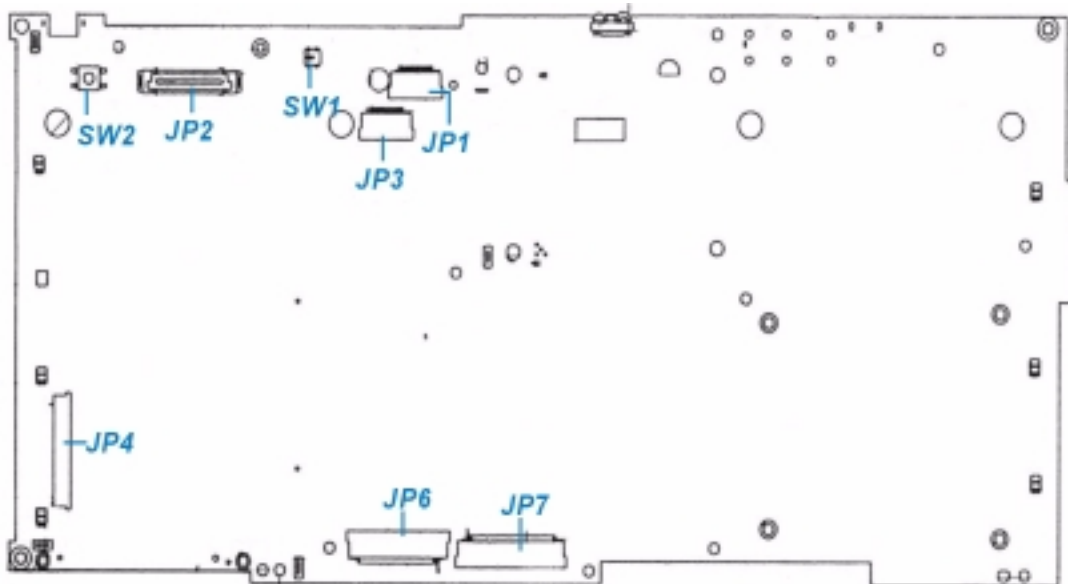

PCB 01200-S

SW2	Power On/Off button	JP1	It is software debug only, normally shipping on this connector
JP2	LCD connector	JP7	FDD connector
SW1	LID switch	JP6	Internal keyboard connector
JP3	System Board connector	JP4	Switch board connector

SW2 POWER.-BTN

PIN NO	Signal	PIN NO	Signal
1.	ON/OFF BTN#	2.	ON/OFF BTN#
3.	GND	4.	GND

JP2 LCD

PIN NO	Signal	PIN NO	Signal
1.	+5VALW	2.	GND
3.	+5VALW	4.	GND
5.	NC	6.	NC
7.	20 INVT_PWN	8.	DISPOFF#
9.	+5VALW	10.	LCDDVDD

PIN NO	Signal	PIN NO	Signal
11.	+5VALW	12.	LCDVDD
13.	+3VS	14.	LCDDVGA
15.	+3VS	16.	LCDDVGA
17.	GND	18.	GND
19.	NC	20.	L LCD0
21.	GND	22.	L LCD1
23.	PID0	24.	GND
25.	PID1	26.	L LCD2
27.	PID2	28.	L LCD3
29.	PID3	30.	GDN
31.	ENVDD	32.	L LCD4
33.	DISPOFF#	34.	L LCD5
35.	L LCD15	36.	GDN
37.	L LCD14	38.	L LCD6
39.	GND	40.	L LCD7
41.	L LCD13	42.	GDN
43.	L LCD12	44.	L LCD8
45.	GND	46.	L LCD9
47.	L LCD11	48.	GDN
49.	L LCD10	50.	NC

SW1 LID-SW

PIN NO	Signal	PIN NO	Signal
1.	GND	2.	GND
3.	LID_SW#	4.	LID_SW#

JP3 HEADERX.PRT

PIN NO	Signal	PIN NO	Signal
1.	+5VALW	2.	ACIN
3.	HDD_LED#	4.	CD_FDD_LED#
5.	CAPS_LED#	6.	ARROW_LED#
7.	NUM_LED#	8.	GND
9.	+3VS	10.	+3VS

JP1 DEBUG-9.PRT

PIN NO	Signal	PIN NO	Signal
1.	+5V	2.	GND
3.	RXD0F#	4.	TXD0F#
5.	DSR0F	6.	RTS0F
7.	CTS0F	8.	DTR0F
9.	RI0F	10.	D0F

JP7 FDD.PRT

PIN NO	Signal	PIN NO	Signal
1.	+5VS	2.	INDEX#
3.	+5VS	4.	DRV0#
5.	+5VS	6.	DSKCHG#
7.	NC	8.	NC
9.	NC	10.	MTR0#
11.	NC	12.	FDDIR#
13.	3MODE#	14.	STEP#
15.	NC	16.	NC
17.	GND	18.	WGARE#
19.	GND	20.	TRACK0#
21.	GND	22.	WP#
23.	GND	24.	RDATA#
25.	GND	26.	HDSEL#

JP6 KBD

PIN NO	Signal	PIN NO	Signal
1.	KSO15	2.	KSO10
3.	KSO11	4.	KSO14
5.	KSO13	6.	KSO12
7.	KSO3	8.	KSO6
9.	KS08	10.	KSO7
11.	KS04	12.	KSO2
13.	KSI0	14.	KSO1
15.	KSO5	16.	KSI3
17.	KSI2	18.	KSO0
19.	KS15	20.	KSI4
21.	KSO9	22.	KSO9
23.	KSI7	24.	KSI1

JP4 HEADERX 50

PIN NO	Signal	PIN NO	Signal
1.	NC	2.	BTN1#
3.	BTN2#	4.	MAIL_ACT_LED#
5.	BTN4#	6.	BTN3#
7.	CDON_BTN#	8.	VOL_UP#
9.	VOL_DW#	10.	VOL_AMP
11.	NC	12.	PWR_LED#
13.	BUT_LOCK#	14.	EMAIL_ON#
15.	PS2_CLK	16.	PS2_DATA
17.	NC	18.	NC
19.	NC	20.	NC
21.	NC	22.	IAC_BITCLK
23.	IAC_SDATAI	24.	IAC_SDATAO

PIN NO	Signal	PIN NO	Signal
25.	IAC_SDATAI	26.	IAC_RST#
27.	GND	28.	BATT_LOW_LED#
29.	GND	30.	DM_ON
31.	DM_ON#	32.	GND
33.	BATT_CHGI_LED#	34.	NC
35.	MD_SPK	36.	NC
37.	MONO IN R	38.	CD_AGND
39.	CD_AGND	40.	CDROM_L
41.	CD_AGND	42.	+3VS
43.	NC	44.	+5VCD
45.	+5VCD	46.	+5VCD
47.	NC	48.	+5VAW
49.	+5VS	50.	+5VS

SW1 Settings (Lid switch)

	Setting
Switch 1	NONE
Switch 2	STAND BY
Switch 3	HIBERNATE
Switch 4	ON/OFF BUTTON

SW2 Settings

SW2	Setting
POWER BUTTON	ON:SYSTEM ON OFF: SYSTEM OFF

Bottom View

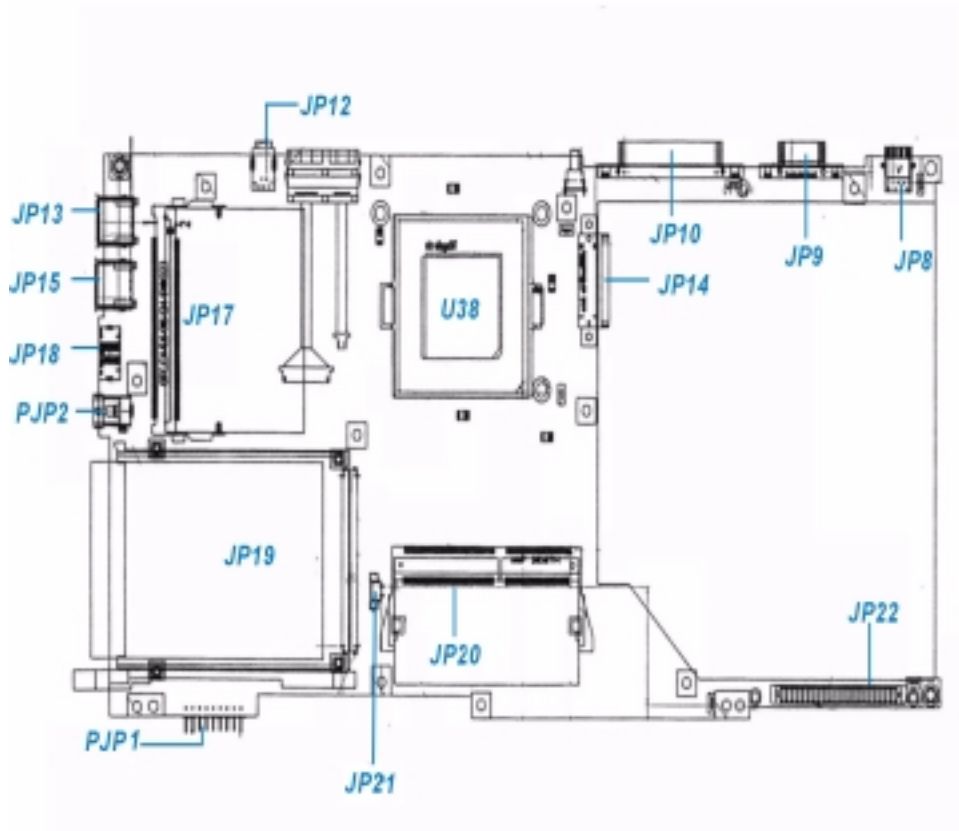

JP12	1394 Connector	JP21	CPU fan connector
U38	CPU socket for FC-PGA370	JP19	PCMCIA socket connector
JP14	CD-ROM connector	PJP1	Battery connector
JP10	Print port connector	PJP2	AC adapter input connector
JP9	CRT connector	JP18	PS/2 keyboard and PS/2 mouse connector
JP8	TV out connector for S-video only	JP15	USB connector
JP22	HDD connector	JP13	USB connector
JP20	So-DIMM connector for SDRAM only	JP17	Mini PCI connector

JP12 1394.PRT

PIN NO	Signal	PIN NO	Signal
1.	10TPBO	2.	TPBO+
3.	TPAO-	4.	TPAO+

U38 PGA370

PIN NO	Signal	PIN NO	Signal
A3	D29#	AD34	GND
A5	D28#	AD36	Vcc1.5

PIN NO	Signal	PIN NO	Signal
A7	D43#	AE1	A17#
A9	D37#	AE3	A22#
A11	D44#	AE5	VccCORE
A13	D51#	AE33	A20M#
A15	D47#	AE55	IERR#
A17	D48#	AE37	FLUSH#
A19	D57#	AF2	VccCORE
A21	D46#	AF4	A35#
A23	D53#	AF6	A25
A25	D60#	AF32	GND
A27	D61#	AF34	VccCORE
A29	DEP7#	AF36	GND
A31	DEP3#	AG1	EDGCTRL5
A33	DEP2#	AG3	A19#
A35	PRDY#	AG5	GND
A37	GND	AG33	INIT#
AA1	A27#	AG35	STPCLK#
AA3	A30#	AG37	IGNNE#
AA5	VccCORE	AH2	GND
AA33	VTT4	AH4	RESET#2
AA35	VTT4	AH6	A10#
AA37	VccCORE	AH8	A5#
AB2	VccCORE	AH10	A8#
AB4	A24#	AH12	A4#
AB6	A23#	AH14	BNR#
AB32	GND	AH16	REQ1#
AB34	VccCORE	AH18	REQ2#
AB36	VccCMOS	AH20	VTT
AC1	A33#	AH22	RS1#
AC3	A20#	AH24	VccCORE
AC5	GND	AH26	RS0#
AC33	GND	AH28	THERMTRIP#
AC35	FERR#	AH30	SLP#
AC37	RSP#	AH32	VccCORE
AD2	GND	AH34	GND
AD4	A31#	AH36	VccCORE
AD6	VREF5	AJ1	A21#
AD32	VccCORE	AJ3	GND
AJ5	VccCORE	AL11	AP0#
AJ7	GND	AL13	VTT
AJ9	VccCORE	AL15	A7#
AJ11	GND	AL17	REQ4#
AJ13	VccCORE	AL19	REQ3#
J15	GND	AL21	VTT
AJ17	VccCORE	AL23	HITM#
AJ19	GND	AL25	HIT#

PIN NO	Signal	PIN NO	Signal
AJ21	VccCORE	AL27	BDSY#
AJ23	GND	AL29	THERMDN
AJ25	VccCORE	AL31	THERMDP
AJ27	GND	AL33	TCK
AJ29	VccCORE	AL35	VID0
AJ31	BSEL1	AL37	VID2
AJ33	BSEL0	AM26	Reserved
AJ35	SMI#	AM4	Vcccore
AJ37	VID3	AM6	GDN
AK2	VccCORE	AM8	Vcccore
AK4	GND	AM10	GDN
AK6	A28#	AM12	Vcccore
AK8	A3#	AM14	GDN
AK10	A11#	AM16	Vcccore
AK12	VREF6	AM18	GDN
AK14	A14#	AM20	VccCORE
AK16	VTT	AM22	GDN
AK18	REQ0#	AM24	VccCORE
AK20	LOCK#	AM26	GDN
AK22	VREF7#	AM28	VccCORE
AK24	AERR#	AM30	GDN
AK26	PWRGOOD	AM32	VccCORE
AK28	RS2#	AM34	GDN
AK30	Reserved	AM36	VID1
AK32	TMS	AN3	GDN
AK34	VccCORE	AN5	A12#
AK36	GND	AN7	A16#
AL1	GND	AN9	A6#
AL3	GND	AN11	VTT
AL5	A15#	AN13	AP1#
AL7	A13#	AN15	VTT
AL9	A9#	AN17	BPRI#
AN19	DEFER#	C25	D50#
AN21	VTT4	C27	D56#
AN23	RP#	C29	DEP5#
AN25	TRDY#	C31	DEP1#
AN27	DRDY#	C33	DEP0#
AN29	BR0#	C35	BPM0#
AN31	ADS#	C37	CPUPRES#
AN33	TRST#	D2	GND
AN35	TDI	D4	GND
AN37	TDO	D6	VccCORE
B2	D35#	D8	D38#
B4	GND	D10	D39#
B6	VccCORE	D12	D42#
B8	GND	D14	D41#

PIN NO	Signal	PIN NO	Signal
B10	VccCORE	D16	D52#
B12	GND	D18	GND
B14	VccCORE	D20	VccCORE
B16	GND	D22	GND
B18	VccCORE	D24	VccCORE
B20	GND	D26	GND
B22	VccCORE	D28	VccCORE
B24	GND	D30	GND
B26	VccCORE	D32	VccCORE
B28	GND	D34	GND
B30	VccCORE	D36	VccCORE
B32	GND	E1	D26#
B34	VccCORE	E3	D25#
B36	BINIT#	E5	VccCORE
C1	D33#	E7	GND
C3	VccCORE	E9	VccCORE
C5	D31#	E11	GND
C7	D34#	E13	VccCORE
C9	D36#	E15	GND
C11	D45#	E17	VccCORE
C13	D49#	E19	GND
C15	D40#	E21	RESERVED
C17	D59#	E23	VTT4
C19	D55#	E25	D62#
C21	D54#	E27	SLEWCTRL
C23	D58#	E29	DEP6#
E31	DEP4#	K2	VccCORE
E33	VREF0	K4	VREF2
E35	BPM1#	K6	D24#
E37	BP3#	K32	VccCORE
F2	VccCORE	K34	VccCORE
F4	VccCORE	K36	GND
F6	D32#	L1	D13#
F8	D22#	L3	D20#
F10	Reserved	L5	GND
F12	D27#	L33	Reserved
F14	VccCORE	L35	PICD1
F16	D63#	L37	LINT1/NMI
F18	VREF1	M2	GND
F20	GND	M4	D11#
F22	VccCORE	M6	D3#
F24	GND	M32	VccCORE
F26	VccCORE	M34	GND
F28	GND	M36	LINT0/INTR
F30	VccCORE	N1	D2#
F32	GND	N3	D14#

PIN NO	Signal	PIN NO	Signal
F34	VccCORE	N5	VccCORE
F36	GND	N33	Reserved
G1	D21#	N35	Reserved
G3	D23#	N37	Reserved
G5	GND	P2	VccCORE
G33	BP2#	P4	D18#
G35	VTT	P6	D9#
G37	Reserved	P32	GND
H2	GND	P34	VccCORE
H4	D16#	P36	GND
H6	D19#	Q1	D12#
H32	VccCORE	Q3	D10#
H34	GND	Q5	GND
H36	VccCORE	Q33	Reserved
J1	D7#	Q35	Reserved
J3	D30#	Q37	Reserved
J5	VccCORE	R2	Reserved
J33	PICCLK	R4	D17#
J35	PICD0	R6	VREF3
J37	PREQ#	R32	VccCORE
R34	GND	V36	VccCORE
R36	VccCORE	W1	D0#
S1	D8#	W3	A34#
S3	D5#	W5	VccCORE
S5	VccCORE	W33	PLL1
S33	VTT4	W35	Reserved
S35	RTTCTRL	W37	BCLK
S37	VTT4	X2	BR1#
T2	VccCORE	X4	RESET2#2
T4	D1#	X6	A32#
T6	D6#	X32	GND
T32	GND	X34	VccCORE
T34	VccCORE	X36	GND
T36	GND	Y1	Reserved
U1	D4#	Y3	A26#
U3	D15#	Y5	GND
U5	GND	Y33	GLKREF7
U33	PLL2	Y35	VccCORE
U35	VTT4	Y37	GND
U37	VTT4	Z2	GND
V2	GND	Z4	A29#
V4	BERR#	Z6	A18#
V6	VREF4	Z32	VccCORE
V32	VCCCORE	Z34	GND
V34	GND	Z36	VCC2.51

JP14 CD.PRT

PIN NO	Signal	PIN NO	Signal
1.	INT_CD_L	2.	INT_CD_R
3.	CD_AGND	4.	GND
5.	SIDERST#	6.	CDD8
7.	CDD7	8.	CDD9
9.	CDD6	10.	CDD10
11.	CDD5	12.	CDD11
13.	CDD4	14.	CDD12
15.	CDD3	16.	CDD13
17.	CDD2	18.	CDD14
19.	CDD1	20.	CDD15
21.	CDD0	22.	CD_DREQ
23.	GND	24.	CD_SIOR#
25.	CD_SLOW	26.	GND
27.	CD_SIORY	28.	CD_DACK#
29.	CD_IRQ	30.	NC
31.	CD_SBA1	32.	PDIAG#
33.	CD_SBA0	34.	CD_SBA2
35.	CD_SCS1#	36.	CD_SCS3#
37.	SHDD_LED#	38.	+5VCD
39.	+50CD	40.	+50CD
41.	+50CD	42.	+50CD
43.	GND	44.	GND
45.	GND	46.	GND
47.	NC	48.	GND
49.	NC	50.	NC

JP10 LPTCN-25.PRT

PIN NO	Signal	PIN NO	Signal
1.	+5V_PRN	2.	FD0
3.	FD1	4.	FD2
5.	FD3	6.	FD4
7.	FD5	8.	FD6
9.	FD7	10.	ACK#

JP9 CRT CONN..PRT

PIN NO	Signal	PIN NO	Signal
1.	CRTR	2.	CRTG
3.	CRTB	4.	NC
5.	GND	6.	GND
7.	GND	8.	GND
9.	CRTVCC	10.	GND
11.	NC	12.	DDCD
13.	HSYNC	14.	VSYNC

PIN NO	Signal	PIN NO	Signal
15.	DDCC		

JP8 S CONN..PRT

PIN NO	Signal	PIN NO	Signal
1.	GND	2.	N.C.
3.	GND	4.	LUMA
5.	NC	6.	CRMA
7.	COMPS		

JP22 HDD

PIN NO	Signal	PIN NO	Signal
1.	PIDERST#	2.	GND
3.	PBD7	4.	PBD8
5.	PBD6	6.	PBD9
7.	PBD5	8.	PBD10
9.	PBD4	10.	PBD11
11.	PBD3	12.	PBD12
13.	PBD2	14.	PBD13
15.	PBD1	16.	PBD14
17.	PBD0	18.	PBD15
19.	GND	20.	NC
21.	PBDREQ	22.	NC
23.	PBIOW#	24.	GND
25.	PBDIOR#	26.	GND
27.	PBIORDY	28.	PCSEL
29.	PBDACK#	30.	GND
31.	IRQ14	32.	NC
33.	PBA1	34.	NC
35.	PBA0	36.	PBA2
37.	PBCS1#	38.	PBC3#
39.	HDD_LED#	40.	GND
41.	+5VS	42.	+5VS
43.	GND	44.	NC

JP20 144 SODIMMI.PRT

PIN NO	Signal	PIN NO	Signal
1.	GND	2.	GND
3.	MD0	4.	MD8
5.	MD1	6.	MD9
7.	MD2	8.	MD10
9.	MD3	10.	MD11
11.	+3V	12.	+3V
13.	MD4	14.	MD12
15.	MD5	16.	MD13

PIN NO	Signal	PIN NO	Signal
17.	MD6	18.	MD14
19.	MD7	20.	MD15
21.	GND	22.	GND
23.	RCAS#0	24.	RCAS#1
25.	RCAS#4	26.	RCAS#5
27.	+3V	28.	+3V
29.	MMA0	30.	MMA3
31.	MMA1	32.	MMA4
33.	MMA2	34.	MMA5
35.	GND	36.	GND
37.	MD32	38.	MD40
39.	MD33	40.	MD41
41.	MD34	42.	MD42
43.	MD35	44.	MD43
45.	+3V	46.	+3V
47.	MD36	48.	MD44
49.	MD37	50.	MD45
51.	MD38	52.	MD46
53.	MD39	54.	MD47
55.	GND	56.	GND
57.	NC	58.	NC
59.	NC	60.	NC
61.	CLK_SDRAM2	62.	CKE2
63.	+3V	64.	+3V
65.	SRASA#	66.	SCASA#
67.	RMWEA#	68.	CKE3
69.	RRAS#2	70.	MMA14
71.	RRAS#3	72.	NC
73.	GND	74.	CLK_SDRAM3
75.	GND	76.	GND
77.	NC	78.	NC
79.	NC	80.	NC
81.	+3V	82.	+3V
83.	MD16	84.	MD24
85.	MD17	86.	MD25
87.	MD18	88.	MD26
89.	MD19	90.	MD27
91.	GND	92.	GND
93.	MD20	94.	MD28
95.	MD21	96.	MD29
97.	MD22	98.	MD30
99.	MD23	100.	MD31
101.	+3V	102.	+3V
103.	MMA6	104.	MMA7
105.	MMA8	106.	MMA11
107.	GND	108.	GND

PIN NO	Signal	PIN NO	Signal
109.	MMA9	110.	MMA12
111.	MMA10	112.	MMA13
113.	+3V	114.	+3V
115.	RCAS#2	116.	RCAS#3
117.	RCAS#6	118.	RCAS#7
119.	GND	120.	GND
121.	MD48	122.	MD56
123.	MD49	124.	MD57
125.	MD50	126.	MD58
127.	MD51	128.	MD59
129.	+3V	130.	+3V
131.	MD52	132.	MD60
133.	MD53	134.	MD61
135.	MD54	136.	MD62
137.	MD55	138.	MD63
139.	GND	140.	GND
141.	SDADIMMI	142.	SCKDIMMI
143.	+3V	144.	+3V

JP21 FAN.PRT

PIN NO	Signal	PIN NO	Signal
1.	FAN-SENSE	2.	POWER
3.	GND		

JP19 PCMCIA-CONN. 154P.PRT

PIN NO	Signal	PIN NO	Signal
A1	GND	B1	GND
A2	GND	B2	GND
A3	S1_D3	B3	S2_D3
A4	S1_CD1#	B4	S2_CD1#
A5	S1 D4	B5	S2 D4
A6	S1 D11	B6	S2 D11
A7	S1 D5	B7	S2 D5
A8	S1_D12	B8	S2_D12
A9	GND	B9	GND
A10	S1 D6	B10	S2 D6
A11	S1 D13	B11	S2 D13
A12	S1 D7	B12	S2 D7
A13	D14	B13	S2 D14
A14	S1 CE1#	B14	S2 CE1#
A15	S1 D15	B15	S2 D15
A16	GND	B16	GND
A17	S1 A10	B17	S2 A10
A18	S1 CE2#	B18	S2 CE2#
A19	S1 OE#	B19	S2 OE#

PIN NO	Signal	PIN NO	Signal
A20	S1 VS1	B20	S2 VS1
A21	S1 A11	B21	S2 A11
A22	GND	B22	GND
A23	S1 10RD#	B23	S2 10RD#
A24	S1 A9	B24	S2 A9
A25	S1 10WR/3	B25	S2 10WR/3
A26	S1 A8	B26	S2 A8
A27	S1 A17	B27	S2 A17
A28	GND	B28	GND
A29	S1 A13	B29	S2 A13
A30	S1_A18	B30	S2_A18
A31	S1 A14	B31	S2 A14
A32.	S1 A19	B32	S2 A19
A33.	S1 WE#	B33	S2 WE#
A34.	S1 A20	B34	S2 A20
A35	S1 RDY#	B35	S2 RDY#
A36	S1 A21	B36	S2 A21
A37	S1_VCC	B37	S2_VCC
A38	S1_VCC	B38	S2_VCC
A39	S1_VPP	B39	S2_VPP
A40	S1_VPP	B40	S2_VPP
A41	S1 A16	B41	S2 A16
A42	GND	B42	GND
A43	S1 A22	B43	S2 A22
A44	S1 A15	B44	S2 A15
A45	S1 A23	B45	S2 A23
A46	S1 A12	B46	S2 A12
A47	S1 A24	B47	S2 A24
A48	S1 A7	B48	S2 A7
A49	GND	B49	GND
A50	S1 A25	B50	S2 A25
A51	S1_A6	B51	S2_A6
A52	S1 VS2	B52	S2 VS2
A53	S1 A5	B53	S2 A5
A54	S1 RST	B54	S2 RST
A55	S1 A4	B55	S2 A4
A56	S1 WAIT#	B56	S2 WAIT#
A57	GND	B57	GND
A58	S1 A3	B58	S2 A3
A59	S1 INPACK#	B59	S2 INPACK#
A60	S1 A2	B60	S2 A2
A61	S1 REG#	B61	S2 REG#
A62	S1 A1	B62	S2 A1
A63	S1 BVD2	B63	S2 BVD2
A64	S1 A0	B64	S2 A0
A65	GND	B65	GND

PIN NO	Signal	PIN NO	Signal
A66	S1 BVD1	B66	S2 BVD1
A67	S1 D0	B67	S2 D0
A68	S1 D8	B68	S2 D8
A69	S1 D1	B69	S2 D1
A70	S1 D9	B70	S2 D9
A71	S1 D2	B71	S2 D2
A72	S1 D10	B72	S2 D10
A73	GND	B73	GND
A74	S1 WP	B74	S2 WP
A75	S1 CD2#	B75	S2 CD2#
A76	GND	B76	GND
A77	GND	B77	GND

PJP1 BATT-B.PRT

PIN NO	Signal	PIN NO	Signal
1.	BATT+	2.	VBS
3.	BN1/1L#	4.	TS
5.	EEPROMVCC	6.	BSCL
7.	BQ_BATT/SMD	8	GND

PJP2 ACIN PRT

PIN NO	Signal	PIN NO	Signal
1.	VIN	2.	GND
3.	GND	4.	

JP18 KBD/PS2_6.PRT

PIN NO	Signal	PIN NO	Signal
1.	KBD_DATA	2.	EXT_DATA
3.	GND	4.	PS/2_VCC
5.	KBD_CLK	6.	EXT_CLK

JP13,JP15 USB_CON..PRT

PIN NO	Signal	PIN NO	Signal
1.	USB_UCCA	2.	USB0_D-
3.	USB0_D+	4.	USB_AGND

JP17 124-MINIPCI.PRT

PIN NO	Signal	PIN NO	Signal
1.	NC	2.	NC
3.	NC	4.	NC
5.	NC	6.	NC
7.	NC	8.	NC
9.	NC	10.	NC

PIN NO	Signal	PIN NO	Signal
11.	NC	12.	NC
13.	NC	14.	NC
15.	NC	16.	NC
17.	PIRQB#	18.	+5VS
19.	+3VS_MINIPCI	20.	PIRQD#
21.	NC	22.	NC
23.	GND	24.	3.3VAUX
25.	PCLK_MDM	26.	PCIRST#
27.	GND	28.	+3VS_MINIPCI
29.	REQ#1	30.	GNT#1
31.	+3VS_MINIPCI	32.	GND
33.	AD31	34.	MDMPME#
35.	AD29	36.	NC
37.	GND	38.	AD30
39.	AD27	40.	+3VS_MINIPCI
41.	AD25	42.	AD28
43.	NC	44.	AD26
45.	C/BE#	46.	AD24
47.	AD23	48.	IDSEL
49.	GND	50.	GND
51.	AD21	52.	AD22
53.	AD19	54.	AD20
55.	GND	56.	PAR
57.	AD17	58.	AD18
59.	C/BE#2	60.	AD16
61.	IRDY#	62.	GND
63.	+3VS_MINIPCI	64.	FRAME#
65.	CLKRUN#	66.	TRDY#
67.	SERR#	68.	STOP#
69.	GND	70.	+3VS_MINIPCI
71.	PERR#	72.	DEVSEL#
73.	C/BE#1	74.	GND
75.	AD14	76.	AD15
77.	GND	78.	AD13
79.	AD12	80.	AD11
81.	AD10	82.	GND
83.	GND	84.	AD9
85.	AD8	86.	C/BE#0
87.	AD7	88.	+3VS_MINIPCI
89.	+3VS_MINIPCI	90.	AD6
91.	AD5	92.	AD4
93.	NC	94.	AD2
95.	AD3	96.	AD0
97.	+5VS	98.	NC
99.	AD1	100.	NC
101.	GND	102.	GND

PIN NO	Signal	PIN NO	Signal
103.	VGA_ACSYNC	104.	NC
105.	VGA_ACSDATAI	106.	VGA_ACSDATAO
107.	VGA_ACBITCLK	108.	NC
109.	NC	110.	VGA_ACRST#
111.	BEEP	112.	NC
113.	AGND	114.	GND
115.	MD_MIC	116.	MD_SPK
117.	AGND	118.	AGND
119.	AGND	120.	AGND
121.	MINI_RI#	122.	NC
123.	+5VS	124.	3.3VAUX

FRU (Field Replaceable Unit) List

This chapter gives you the FRU (Field Replaceable Unit) listing in global configurations of TravelMate α 550. Refer to this chapter whenever ordering for parts to repair or for RMA (Return Merchandise Authorization).

Please note that WHEN ORDERING FRU PARTS, you should check the most up-to-date information available on your regional web or channel. For whatever reasons a part number change is made, it will not be noted on the printed Service Guide. For ACER AUTHORIZED SERVICE PROVIDERS, your Acer office may have a DIFFERENT part number code from those given in the FRU list of this printed Service Guide. You MUST use the local FRU list provided by your regional Acer office to order FRU parts for repair and service of customer machines.

NOTE: To scrap or to return the defective parts, you should follow the local government ordinance or regulations on how to dispose it properly, or follow the rules set by your regional Acer office on how to return it.

Exploded Diagram

THE SYSTEM

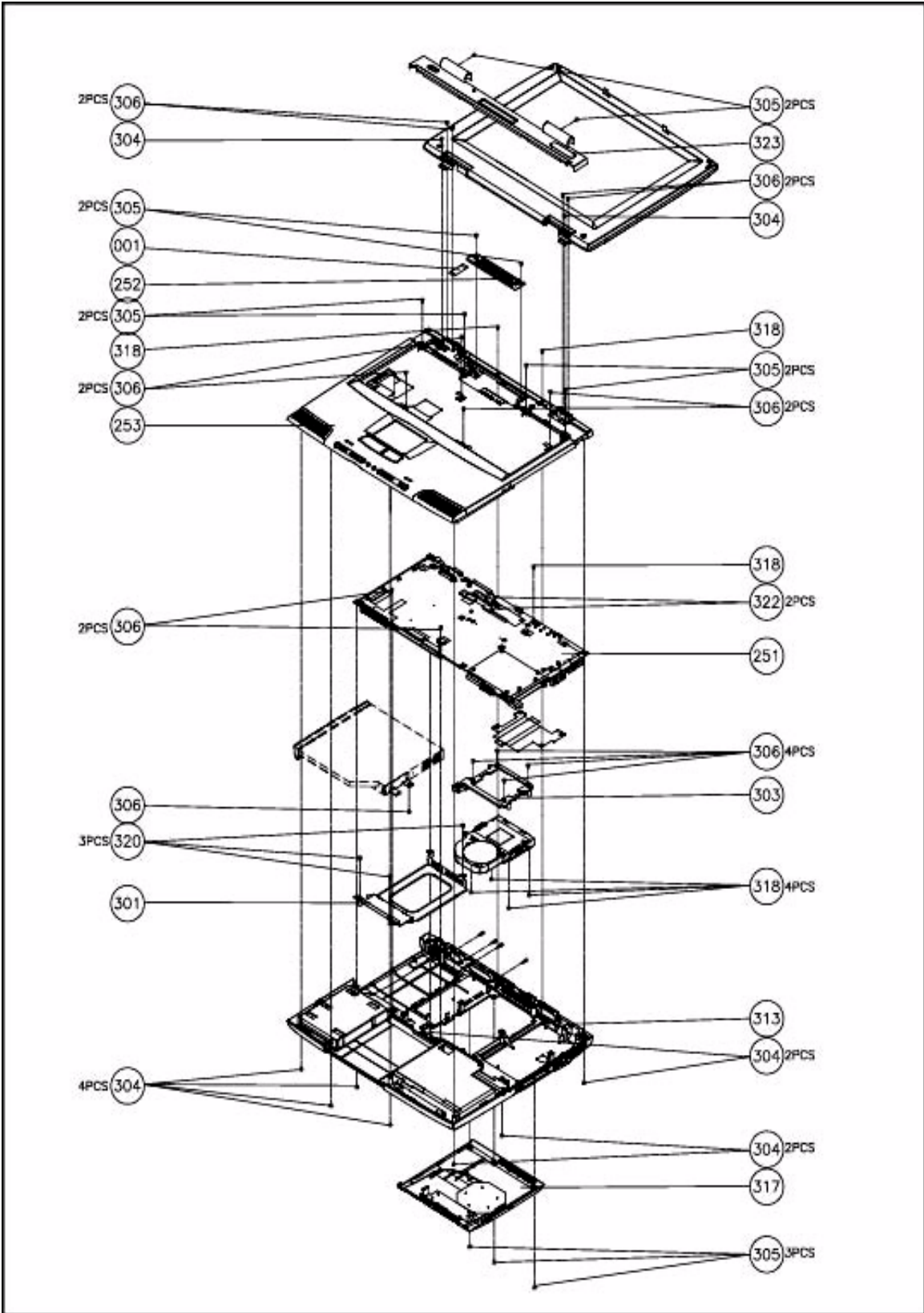

LOGIC UPPER ASSY

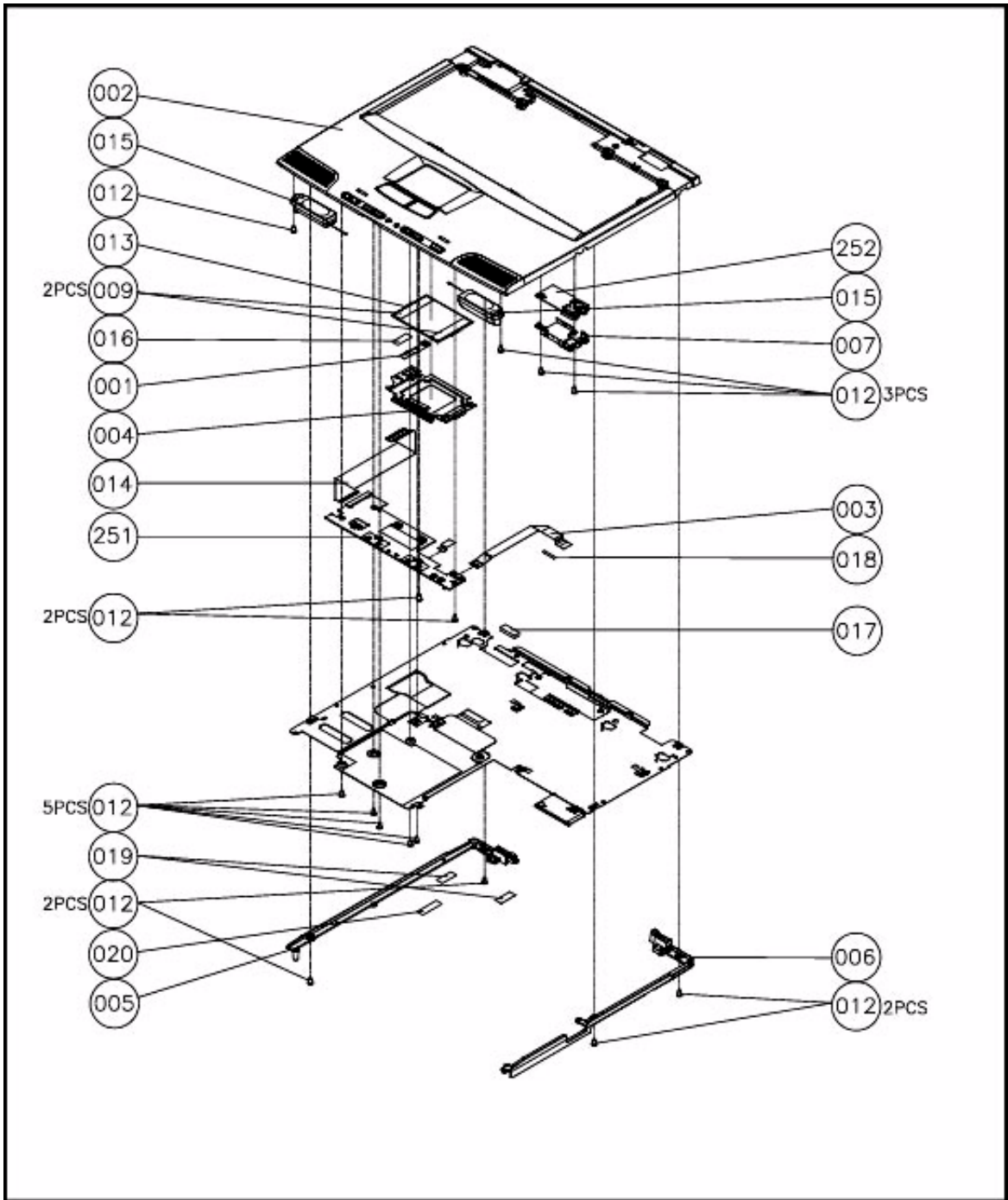

LCD 14.1"

FOR 14.1"

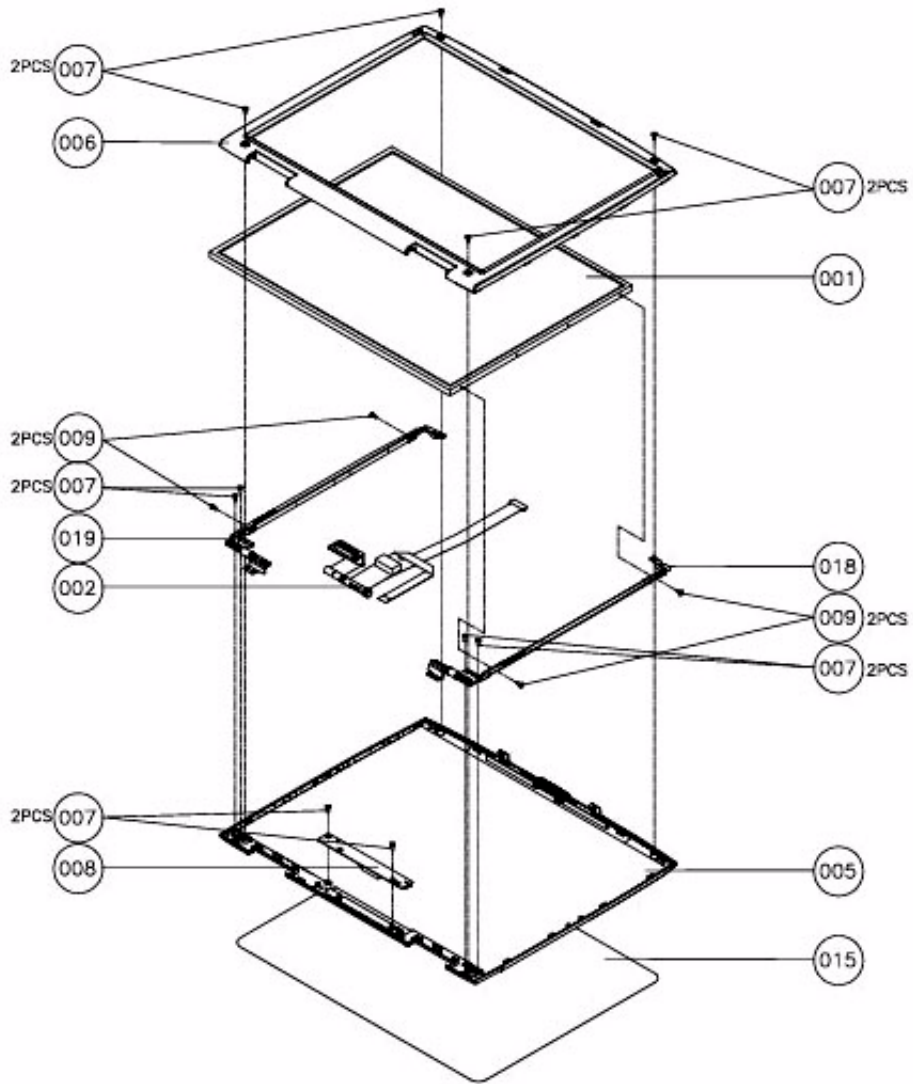

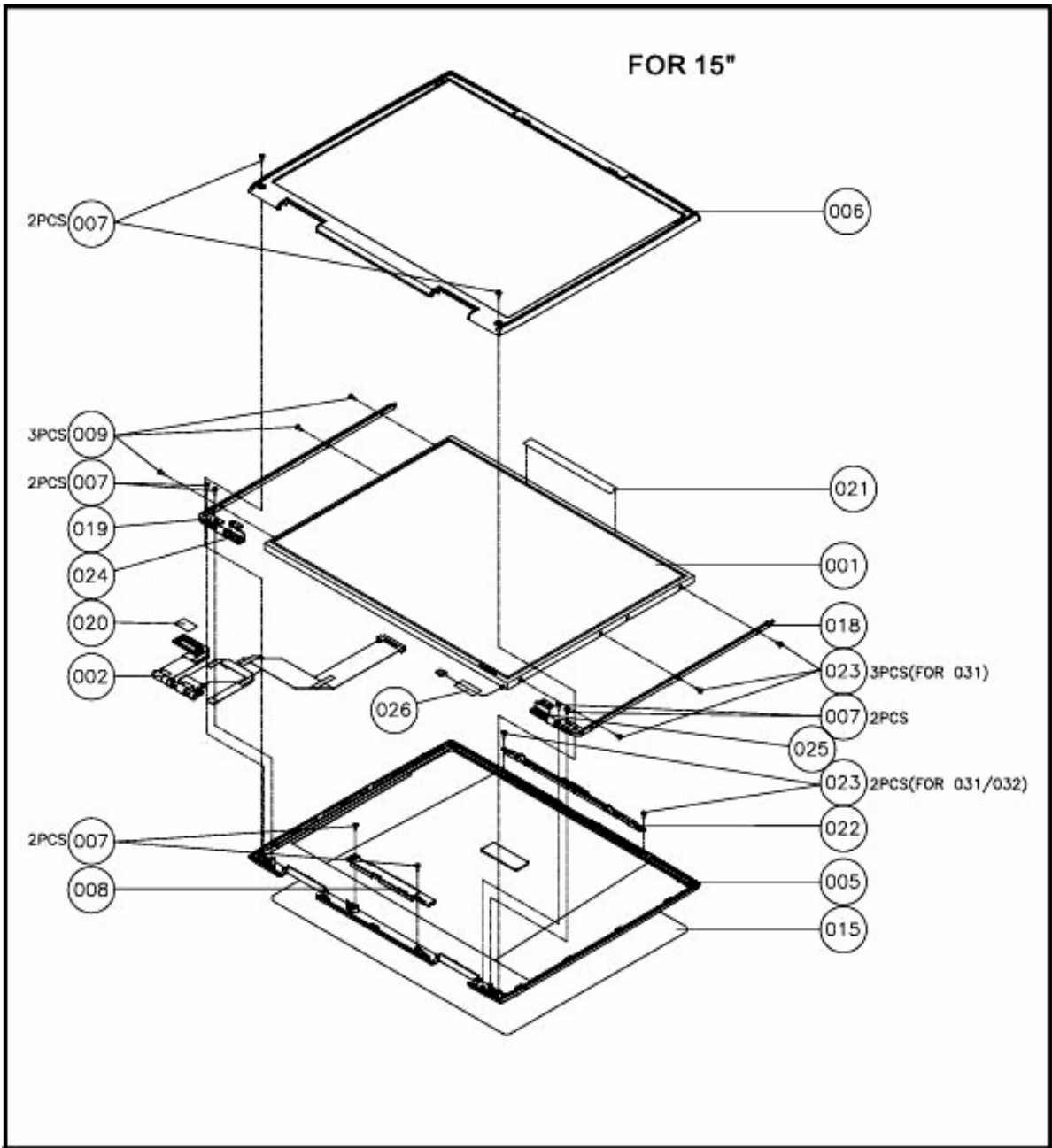

DVD ASSY

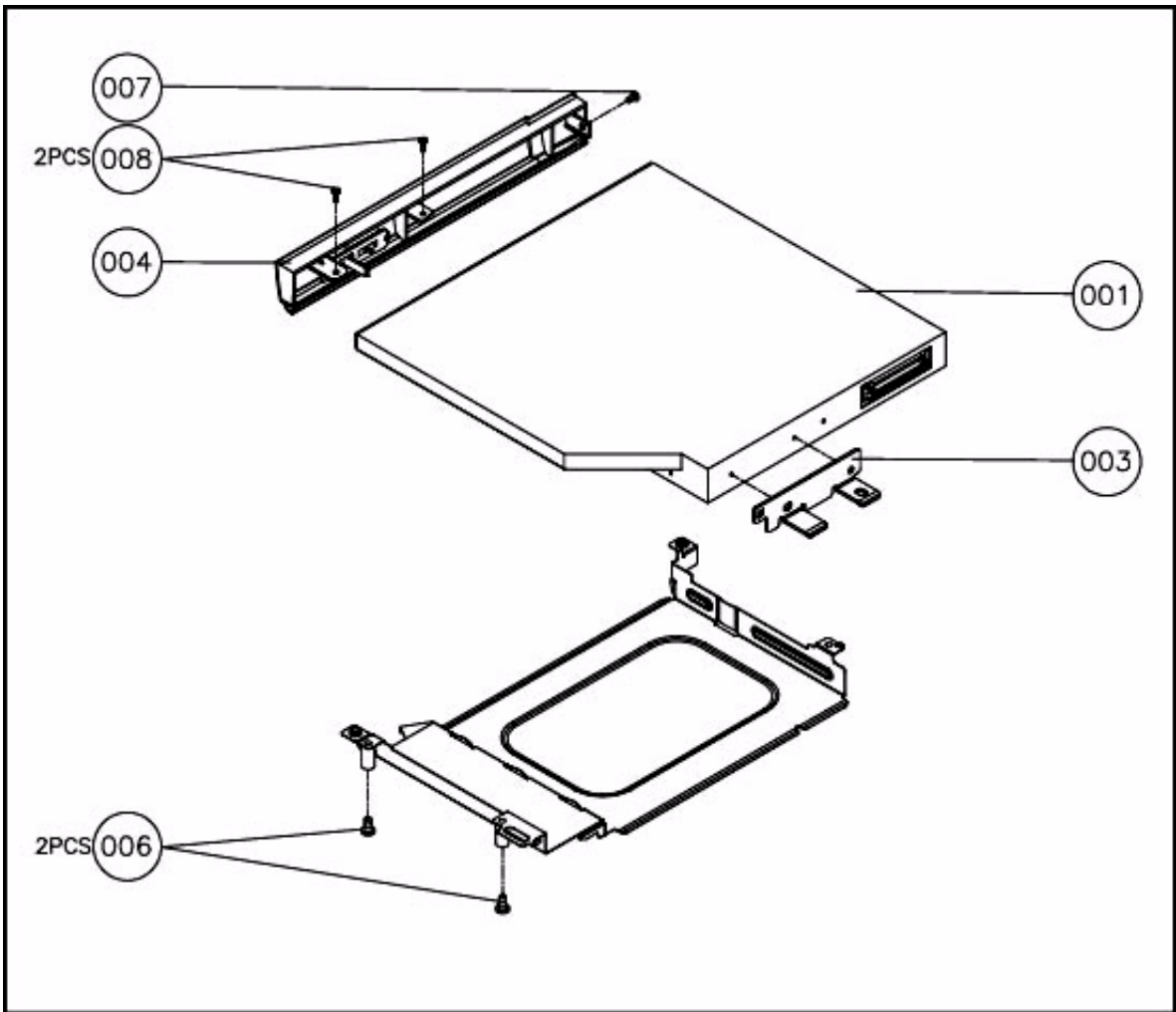





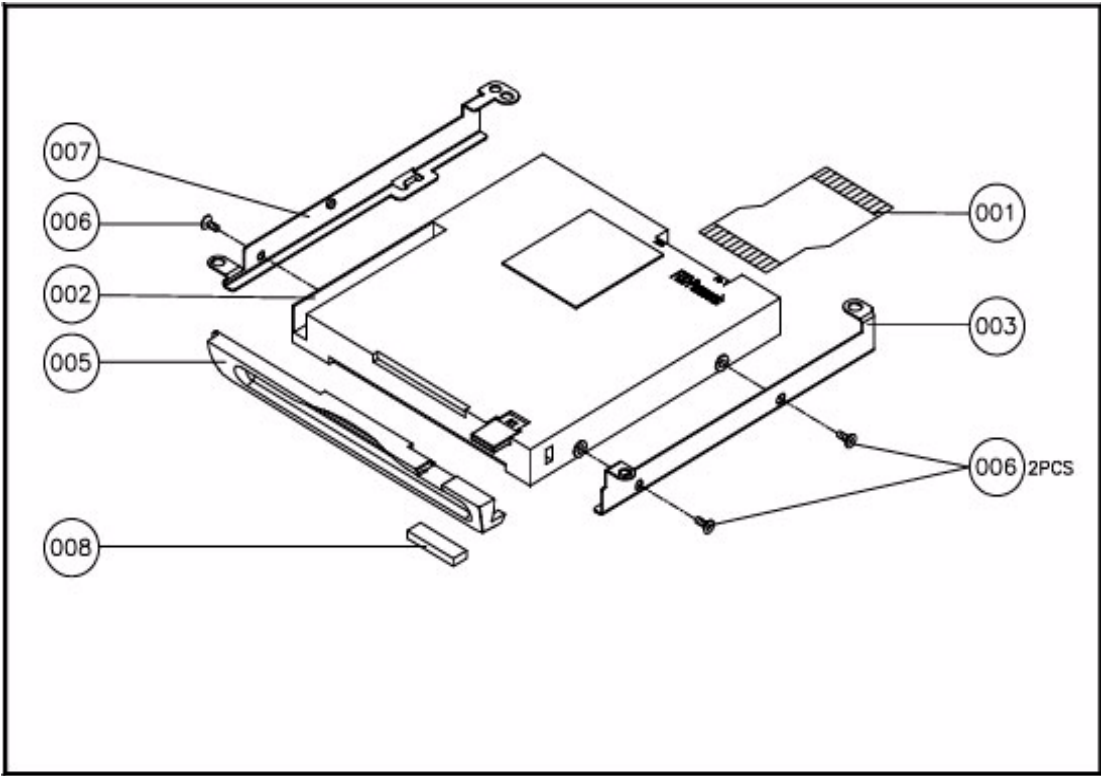

NOTE: The exploded diagrams for CD-ROM, CD-RW, DVD-ROM and DVD-RW module are the same. Therefore, we put only DVD ASSY exploded diagram as your reference. Please also refer to the FRU list below for more information on different models and part numbers. This diagram only explains the relevant location for each part. The part on the exploded diagrams may be different from its actual looks.

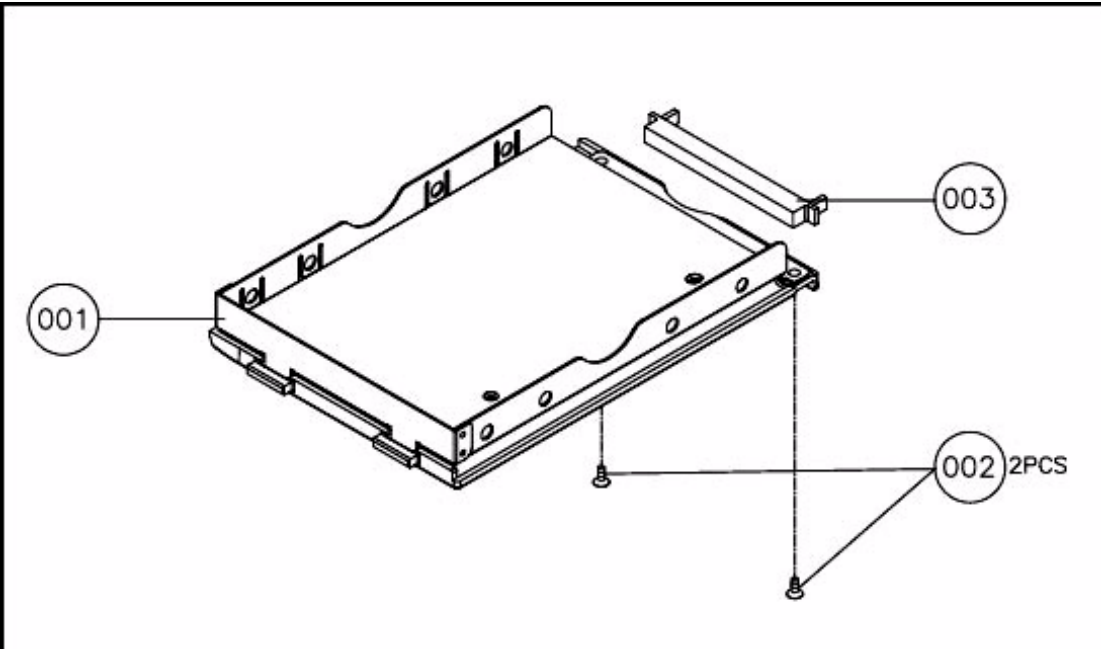
FDD ASSY



HDD (W/O HDD) ASSY









Picture	No.	Partname And Description	Part Number
CPU/Processor			
	NS	CPU-INTEL CELERON 1.2G CPU-COPPERMINE 1G CPU-INTEL PIII 1.13G CUP-INTEL PIII 1.2G	01.ICLON.1G2 01.COPRM 1GE 01.TULAT.1GH 01.TULAT.1GG
	NS	CPU WASHER	V42.0550.008
Memory			
	NS	MEMORY SDIMM 128M APACER PC-133	HKS.0391.001
LCD			
	NS	LCD MODULE 14.1" IBM LCD MODULE 14.1" HANNSTAR LCD MODULE 15.0" LG LCD MODULE 15.0" IBM	V6M.0550.017 V6M.0550.018 V6M.0550.019 V6M.0550.020
	001-LCD 14.1" AND LCD 15"	LCD 14.1" TFT XGA IBM/ITXG77X LCD 14.1" TFT XGA HANNSTAR/HSD141PX11 LCD 15.0" TFT XGA LG/P150X1-G2CP LCD 15.0" TFT SXGA+ IBM/ITSX95C	HLK.1077.001 HLK.2141.001 HLK.0150.001 HLK.1095.001
	008-LCD 14.1" AND LCD 15"	LCD INVERTER BOARD 14.1" IBM LCD INVERTER BOARD 14.1" HANNSTAR LCD INVERTER BOARD 15.0" LG LCD INVERTER BOARD 15.0" IBM	V19.0550.002 V19.0550.002 V19.0550.003 V19.0550.003
	018-LCD 15" 019-LCD 15"	ASSY 14.1" IBM BRACKET W/HINGE ASSY 14.1" HANNSTAR BRACKET W/HING	V6K.0550.003 V6K.0550.004
	NS	LCD BRACKET R-LCD MODULE 15.0" LG LCD BRACKET R-LCD MODULE 15.0" IBM	V33.0550.011 V33.0550.013

Picture	No.	Partname And Description	Part Number
	NS	LCD BRACKET L-LCD MODULE 15.0" LG LCD BRACKET L-LCD MODULE 15.0" IBM	V33.0550.012 V33.0550.014
	NS	LCD PANEL WITH LOGO-LCD MODULE 14.1" IBM AND HANNSTAR LCD PANEL WITH LOGO-LCD MODULE 15.0" LG AND IBM	V60.0550.004 V60.0550.006
	006-LCD 14.1" AND LCD 15"	LCD BEZEL WITH PRINTING-14.1" IBM AND HANNSTAR LCD BEZEL WITH PRINTING-15.0" LG AND IBM	V60.0550.005 V60.0550.007
	002-LCD 14.1" AND LCD 15"	CABLE LCD FPC-14.1" IBM CABLE LCD FPC-14.1" HANNSTAR CABLE LCD FPC-15.0" LG CABLE LCD FPC-15.0" IBM	VCA.0550.013 VCA.0550.014 VCA.0550.015 VCA.0550.016
	022-LCD 15"	LCD LCTCH ASSY	V60.0550.008
	024 AND 025-NS LCD 15"	LCD HINGE ASSY (R & L)	V6K.0550.005
PCMCIA Slot/PC Card slot			
	NS	PCMCIA SLOT	V22.0550.001





Picture	No.	Partname And Description	Part Number
FDD/Floppy Disk Drive			
	NS	FDD MODULE, PANASONIC FDD MOUDLE, MITSUMI	V6M.0550.007 V6M.0550.008
	002-FDD ASSYS	FDD 1.44MB SLIM PANASONIC/JU226A252FC FDD 1.44MB SLIM MITSUMI/JU226A252FC	HKF.0226.001 HKF.0226.002
HDD/ Hard Disk Drive			
	NS	HDD MODULE 15G TOSHIBA HDD MODULE 15G IBM/ HDD MODULE 20G TOSHIBA HDD MODULE 20G IBM HDD MODULE 30G TOSHIBA HDD MODULE 30G IBM	V6M.0550.009 V6M.0550.010 V6M.0550.011 V6M.0550.012 V6M.0550.013 V6M.0550.014
	NS	HDD 15G TOSHIBA/MK1517 HDD 15G IBM/IC25N015ATD HDD 20G TOSHIBA/MK2017 HDD 20G IBM/IC25N020ATD HDD 30G TOSHIBA/MK3017 HDD 30G IBM/IC25N030ATD	HKH.0151.001 HKH.0205.001 HKH.0201.001 56.02041.001 HKH.0301.001 56.02051.001
Combo Drive			
	NS	CD-ROM MODULE 24X TEAC CD-ROM MODULE 24X TOSHIBA CD-RW MODULE 8X KME CD-RW MODULE 8X TOSHIBA DVD-ROM MODULE 8X TOSHIBA DVD-RW MODULE TOSHIBA	V6M.0550.001 V6M.0550.002 V6M.0550.003 V6M.0550.004 V6M.0550.005 V6M.0550.006
	001-DVD ROM ASSY	CD-ROM 24X TEAC/CD224EBP5 CD-ROM 24X TOSHIBA/7002BCR CD-RW 8X KME/UJDA330 CD-RW 8X TOSHIBA/SR-C8002 DVD-ROM 8X TOSHIBA/C2502 DVD-RW TOSHIBA/SDR2002	HKD.0224.001 HKD.0700.001 HKR.0330.001 HKR.0800.001 HKV.0250.001 HKV.0210.001
Fan			

Picture	No.	Partname And Description	Part Number
	NS	THERMAL MODULE WITH FAN	V6M.0550.021
Cables			
	NS		
	001-THE SYSTEM	CABLE-FFC (TOUCH PAD TO SWITCH BOARD)	VCA.0550.004
	003-LOGIC UPPER ASSY	CABLE-FPC (AUDIO TO SWITCH BOARD)	VCA.0550.001
	014-LOGIC UPPER ASSY	CABLE-FPC (SWITCH BOARD TO MAIN BOARD)	VCA.0550.002
	001-THE SYSTEM	CABLE-FPC (SYSTEM WINDOW TO MAIN BOARD)	VCA.0550.003
	001-FDD ASSY	FDD CABLE-FPC (PANASONIC) FDD CABLE-FPC (MITSUMI)	VCA.0550.009 VCA.0550.010

Picture	No.	Partname And Description	Part Number
	NS	HDD CONNECTOR	V20.0550.001
Boards			
	251-THE SYSTEM	MAIN BOARD WITH PCMCIA SLOT/128MB RAM ON BOARD	HMB.2550.001
	252-LOGIC UPPER ASSY	AUDIO BOARD	V55.0550.0101
	NS	COMBO CARD	V55.0550.002
	251-LOGIC UPPER ASSY	SWITCH BOARD	V55.0550.003
	252-THE SYSTEM	SYSTEM WINDOW BOARD	V55.0550.004
Adapter			
	NS	ADAPTER PA-1600-02 CA 60W 3 PINS	HAP.0060.001

Picture	No.	Partname And Description	Part Number
Battery			
	NS	BATTERY PANASONIC-LI-ION 3900mAh BATTERY SAMSUNG-LI-ION 3900mAh	HBT.0186.001 HBT.0186.002
Keyboard			
	NS	KEYBOARD US CHICONY KEYBOARD UK CHICONY KEYBOARD GERMAN CHICONY KEYBOARD ITALIAN CHICONY KEYBOARD TRADITIONAL CHINESE CHICONY	HKB.0013.001 HKB.0013.002 HKB.0013.003 HKB.0013.004 HKB.0013.005
Case/Cover/Bracket Assembly			
	003-FDD ASSY	FDD BRACKET LEFT-PANASONIC FDD BRACKET LEFT-MITSUMI	V33.0550.007 V33.0550.009
	007-FDD ASSY	FDD BRACKET RIGHT-PANASONIC FDD BRACKET RIGHT-MITSUMI	V33.0550.008 V33.0550.010
	004-LOGIC UPPER ASSY	TOUCH PAD BRACKET	V33.0550.002
	301-THE SYSTEM	OPTICAL BRACKET (DVD BRACKET)	V33.0550.001
	008-FDD ASSY	FDD DOOR-PANASONIC FDD DOOR-MITSUMI	V42.0550.011 V42.0550.012

Picture	No.	Partname And Description	Part Number
	004-DVD ASSY	CD-ROM DOOR 24X TEAC CD-ROM DOOR 24X TOSHIBA CD-RW 8X KME CD-RW 8X TOSHIBA DVD-ROM 8X TOSHIBA DVD-RW 8X TOSHIBA	V42.0550.004 V42.0550.005 V42.0550.006 V42.0550.007 V42.0550.009 V42.0550.010
	303-THE SYSTEM	THERMAL BRACKET	V33.0550.003
	003-DVD ASSY	OPTICAL LOCK	V33.0550.006
	253-THE SYSTEM	UPPER CASE	VHV.0550.002
	323-THE SYSTEM	MIDDLE COVER W/O NAME PLATE	V42.0550.001
	313-THE SYSTEM	LOWER CASE W/O DIMM DOOR	VHV.0550.001
	NS	EMI SHIELDING	V60.0550.001

Picture	No.	Partname And Description	Part Number
	317-THE SYSTEM	DIMM COVER W/O SCREW	V42.0550.002
	007-LOGIC UPPER ASSY	AUDIO SHIELDING	V42.0550.003
	006-LOGIC UPPER ASSY	HINGE SADDLE BRACKET-L (CD-ROM SIDE)	V33.0550.004
	006-LOGIC UPPER ASSY	HINGE SADDLE BRACKET-R (PCMCIA SIDE)	V33.0550.005
Others			
	015-LOGIC UPPER ASSY	SPEAKER	VSP.0550.001
	013-LOGIC UPPER ASSY	TOUCH PAD (BACK SIDE)	V60.0550.009
Screws			
	NS	SCREW, M2.5X0.45+3K-ZK(NL)	V86.0550.001
	318-THE SYSTEM; 012-LOGIC UPPER ASSY	SCREW, M2.5X0.45+4FP-NI(NL)	V86.0550.002

Picture	No.	Partname And Description	Part Number
	306-THE SYSTEM	SCREW, M2.5X0.45+8FP-NI(NL)	V86.0550.003
	304-THE SYSTEM	SCREW, M2.5X0.45+18FP-ZK(NL)	V86.0550.004
	320-THE SYSTEM	SCREW, M2.0X0.4+5FP-NI(NL)	V86.0550.005
	NS	SCREW, M2.0X0.4+6P-NI	V86.0550.006
	NS	SCREW, M3.0X0.8+3K-NL	V86.0550.007
	NS	SCREW,TPA-2.0X4FP-ZK FOR CD-ROM ASSY, SECURE THE CD-ROM DOOR	V86.0550.008
	006-DVD ASSY	SCREW, M2.0X4.0+3K-ZK SECURE THE DVD OPTICAL BRACKET OR CD-ROM OPTICAL LOCK	V86.0550.009
	008-DVD ASSY	SCREW, TPA-1.7 3.5FP-ZK	V86.0550.010
	007-DVD ASSY	SCREW, M1.7X0.35+3FP-ZK	V86.0550.011
	NS	SCREW, M3X0.5+6P-NI(NL)	V86.0550.012
	007-LCD 14.1" AND LCD 15"	SCREW, M2.5X0.45P+5K-ZK(NL)	V86.0550.013
	002-HDD ASSY	SCREW, M2.5X0.45+8FP-ZK(NL)	V86.0550.014
	009-LCD 14.1" AND LCD 15"	SCREW, M2.0X0.4P+2.3(NL)	V86.0550.015
	023-LCD15"	SCREW LOCK, 4-40UNC-2A & 4-40UNC-2B	V86.0550.016
	NS	SCREW, M2.0X0.4P+3FP-NI	V86.0550.017
	NS	SAFETY SCREW, M2.5X0.45+6FP-ZK(NL)	V86.0550.018

Model Definition and Configuration

TravelMate α 550

1. Project Name: Compal project

2. Description

TravelMate a 550 uses either INTEL Pentium III processor or INTEL Celeron processor with the VIA chipset delivers a high performance and professional notebook platform solution.

Main memory is expandable to 640MB SDRAM. Powerful data storage with 1.44 MB floppy drive, one E-IDE hard disk and one internal optical drive. As to display, in addition to 14.1/15.0 TFT LCD, TravelMate a 550 also has AGP 4X support and is suitable LCD and CRT display plus S-video (NTSC/PAL) output, DualView support. Audio ports for speaker/headphone-out jack and microphone-in devices provide the user the best quality as he employs the devices above.

Main Features

- Intel® Pentium™ III or Intel® Celeron™ processor with on-die level 2 cache
- 128 MB memory onboard and one memory upgrade slot
- Large LCD display with adjustable video memory
- High-capacity, Enhanced-IDE hard disk
- Lithium-Ion main battery pack
- Power management system
- DualView capability
- Simultaneous LCD and CRT display

Test Compatible Components

This computer's compatibility is tested and verified by Acer's internal testing department. All of its system functions are tested under Windows XP environment.

Refer to the following lists for components, adapter cards, and peripherals which have passed these tests.

Regarding configuration, combination and test procedures, please refer to the TravelMate α 550 Compatibility Test Report released by the Acer Mobile System Testing Department.

Microsoft Windows XP Environment Test

Item	Specifications
Display	ViewSonic PS775 Sony MultiScan G200 Phillips Brilliance 17"
Network Adapters	
Ethernet/10baseT/100baseT	3Com Ethernet Megahertz 10/100 Lan Cardbus
Modem Adapters	
Modem	Xircom Winglobal Carbus Modem 56K
I/O Peripheral	
I/O - TV	Sony KV-W32MX2 Sony KV-XA25N90
I/O - Keyboard	IBM 104 keys Microsoft MS Natural KB Microsoft MS Natural KD Pro Dell QuietKey KB Acer 6312-H
I/O - Mouse	Logitech M-S34 Logitech M-S35 Logitech Serial Mouse Logitech M-M30 Logitech Mouse man Microsoft IntelliMouse Microsoft IntelliMouse Trackball Microsoft Serial Mouse 2.0
I/O - Parallel (Printer)	Canon Deskject 930C EPSON Stylus Color 1000C EPSON Stylus 740 EPSON LQ2080C Printer HP LaserJet 5P HP LaserJet 2100
I/O - USB	Belkin Express Bus F5U001 HUB IOMega USB 100ZIP
I/O - USB (Printer)	EPSON Stylus Photo 740
I/O - USB (Mouse)	Logitech Trackman marble mouse
I/O - USB (Speaker)	Panasonic USB Speaker EAB-MPC57 Phillips DSS350 Speaker
I/O - IEEE 1394	Bffalo HDD Fujitsu MO DYNA MO640 Sony DV TRV-20
I/O Adapter	
PCMCIA - SCSI	Adaptec SlimSCSI APA-1460AB
PCMCIA - ATA	IOMega Click! PCard 40MB Pretec 32MB Compact Flash Card Pretec 32MB Smart Media CardI

Online Support Information

This section describes online technical support services available to help you repair your Acer Systems.

If you are a distributor, dealer, ASP or TPM, please refer your technical queries to your local Acer branch office. Acer Branch Offices and Regional Business Units may access our website. However some information sources will require a user i.d. and password. These can be obtained directly from Acer CSD Taiwan.

Acer's Website offers you convenient and valuable support resources whenever you need them.

In the Technical Information section you can download information on all of Acer's Notebook, Desktop and Server models including:

- Service guides for all models
- User's manuals
- Training materials
- Main manuals
- Bios updates
- Software utilities
- Schematics
- Spare parts lists
- Chips
- TABs (Technical Announcement Bulletin)

The service repair section provides you with downloadable information on:

- Troubleshooting guides
- Tooling box information
- Repair instructions for specific models
- Basic repair guidelines
- Debug cards for Acer's latest models

For these purposes, we have included an Acrobat File to facilitate the problem-free downloading of our technical material.

Also contained on this website are:

- Detailed information on Acer's International Traveler's Warranty (ITW)
- Returned material authorization procedures
- An overview of all the support services we offer, accompanied by a list of telephone, fax and email contacts for all your technical queries.

We are always looking for ways to optimize and improve our services, so if you have any suggestions or comments, please do not hesitate to communicate these to us.

A

AC Adapter 30, 32
 ACPI 1.0a 23
 AFLASH Utility 45
 Audio 26, 27

B

Battery 28
 Battery Pack 55
 charging indicator 12, 13
 BIOS 23
 package 23
 password control 23
 ROM size 23
 ROM type 23
 vendor 23
 Version 23
 BIOS Setup Utility 37
 BIOS Supports protocol 23
 BIOS Utility 37
 Basic System Settings 39
 Navigating 37
 Onboard Device Configuration 41
 Startup Configuration 40
 System Information 38
 System Security 43, 44
 Board Layout 4
 Bottom View 5
 Top View 4

C

Cache
 controller 23
 size 23
 caps lock
 on indicator 12, 13
 CardBus 27
 computer
 on indicator 12, 13
 Core logic 27
 CPU
 core voltage 23
 I/O voltage 23
 package 23
 type 23

D

DIMM 23
 Combinations 24
 external 56
 package 23
 removing 56
 Speed 23
 voltage 23
 Disassembly
 Battery Pack 54
 CD-ROM/DVD-ROM Module 58
 Floppy Disk Drive 62
 Machine 51
 Procedure Flowchart 53
 Display 3
 DVD-ROM Interface 25

E

Error Symptom-to-Spare Part Index 69
 External CD-ROM Drive Check 66
 External Diskette Drive Check 66

F

Features 1
 features 117
 Flash Utility 45
 Floppy Disk
 removing the 62
 Floppy Disk Drive Interface 24
 FRU (Field Replaceable Unit) List 99

H

Hard disk 24, 27
 Hardware Specifications and Configurations 21
 HDD 24, 27
 Hot Keys 13, 14

I

Indicators 12
 Intermittent Problems 76

J

Jumper and Connector Locations 81

Top View 81
Button View

K

Keyboard 27
Keyboard or Auxiliary Input Device Check 67

L

L2 cache 23
LAN/Modem Combo 24

M

Machine Disassembly 51
media access
 on indicator 12, 13
Memory Check 67
Model Definition 116
Modem 24
Modem Combo Card
 external 57

N

Notebook Manager
 hotkey 17
num lock
 on indicator 12, 13

O

Online Support Information 121
Overview 116

P

Panel 6
 Bottom 11
 left 6
 Rear 9
 right 9
Parallel Port 26
PC Card 12, 27
PCMCIA 27
Pentium III 23
Power System Check 67
 Battery Pack 68
Processor 23

R

RMA 99
RTC 27

S

Second Level Cache 23
Super I/O 27
System
 Block Diagram 3
 Layout 4
System Check Procedures 66
System Diagnostic Diskette 45
System Memory 23
System Specifications 116
 Features 117
System Utilities 37
System Utility Diskette 45

T

Temperature 33
Test Compatible Components 119
Touchpad Check 68
Troubleshooting 65

U

Undetermined Problems 77
USB 27

V

Video 26
 Resolutions 26
Video controller 27

W

Windows 2000 Environment Test 120