

# Acer Aspire 1350 Series

## Service Guide

Service guide files and updates are available on the ACER/CSD web; for more information, please refer to <http://csd.acer.com.tw>

SERVICE CD PART NO.: VD.A10V7.001

PRINTED IN TAIWAN

---

## Revision History

Please refer to the table below for the updates made on Aspire 1350 service guide.

Date	Chapter	Updates

---

## Copyright

Copyright © 2003 by Acer Incorporated. All rights reserved. No part of this publication may be reproduced, transmitted, transcribed, stored in a retrieval system, or translated into any language or computer language, in any form or by any means, electronic, mechanical, magnetic, optical, chemical, manual or otherwise, without the prior written permission of Acer Incorporated.

## Disclaimer

The information in this guide is subject to change without notice.

Acer Incorporated makes no representations or warranties, either expressed or implied, with respect to the contents hereof and specifically disclaims any warranties of merchantability or fitness for any particular purpose. Any Acer Incorporated software described in this manual is sold or licensed "as is". Should the programs prove defective following their purchase, the buyer (and not Acer Incorporated, its distributor, or its dealer) assumes the entire cost of all necessary servicing, repair, and any incidental or consequential damages resulting from any defect in the software.

Acer is a registered trademark of Acer Corporation.

AMD is a registered trademark of AMD Corporation.

Athlon XP-M Thoroughbred and Barton are trademarks of AMD Corporation.

Other brand and product names are trademarks and/or registered trademarks of their respective holders.

---

## Conventions

The following conventions are used in this manual:

<b>SCREEN MESSAGES</b>	Denotes actual messages that appear on screen.
<b>NOTE</b>	Gives bits and pieces of additional information related to the current topic.
<b>WARNING</b>	Alerts you to any damage that might result from doing or not doing specific actions.
<b>CAUTION</b>	Gives precautionary measures to avoid possible hardware or software problems.
<b>IMPORTANT</b>	Reminds you to do specific actions relevant to the accomplishment of procedures.

---

## Preface

Before using this information and the product it supports, please read the following general information.

1. This Service Guide provides you with all technical information relating to the BASIC CONFIGURATION decided for Acer's "global" product offering. To better fit local market requirements and enhance product competitiveness, your regional office MAY have decided to extend the functionality of a machine (e.g. add-on card, modem, or extra memory capability). These LOCALIZED FEATURES will NOT be covered in this generic service guide. In such cases, please contact your regional offices or the responsible personnel/channel to provide you with further technical details.
2. Please note WHEN ORDERING FRU PARTS, that you should check the most up-to-date information available on your regional web or channel. If, for whatever reason, a part number change is made, it will not be noted in the printed Service Guide. For ACER-AUTHORIZED SERVICE PROVIDERS, your Acer office may have a DIFFERENT part number code to those given in the FRU list of this printed Service Guide. You MUST use the list provided by your regional Acer office to order FRU parts for repair and service of customer machines.



<b>Chapter 1</b>	<b>System Specifications</b>	<b>1</b>
	Features .....	1
	System Block Diagram .....	3
	Board Layout .....	4
	Top View .....	4
	Bottom View .....	5
	Outlook View .....	6
	Front View .....	6
	Left Panel .....	7
	Right Panel .....	8
	Rear Panel .....	9
	Bottom Panel .....	10
	Indicators .....	11
	Keyboard .....	12
	Special keys .....	12
	Touchpad .....	16
	Touchpad Basics .....	16
	Launch Keys .....	17
	Hardware Specifications and Configurations .....	18
<b>Chapter 2</b>	<b>System Utilities</b>	<b>27</b>
	BIOS Setup Utility .....	27
	Navigating the BIOS Setup Utility .....	28
	Information .....	29
	Main .....	30
	Advanced .....	32
	Security .....	33
	Boot .....	37
	Exit .....	38
	BIOS Flash Utility .....	39
	System Diagnostic Diskette .....	39
<b>Chapter 3</b>	<b>Machine Disassembly and Replacement</b>	<b>41</b>
	General Information .....	42
	Before You Begin .....	42
	Disassembly Procedure Flowchart .....	43
	Removing the Battery Pack .....	45
	Removing the Memory/MDC (Modem/Bluetooth)/HDD Module .....	46
	Removing the Keyboard/ODD Module/FDD Module .....	47
	Disassembling the Main Unit .....	49
	Disassembling the LCD Module .....	54
	Disassembling the LCD Module-15.1 Inch .....	42
	Disassembling the External Modules .....	57
	Disassembling the HDD Module .....	57
	Disassembling the Floppy Disk Drive Module .....	57
	Disassembling the Optical Drive Module .....	58
<b>Chapter 4</b>	<b>Troubleshooting</b>	<b>59</b>
	System Check Procedures .....	60
	External Diskette Drive Check .....	60
	External CD-ROM Drive Check .....	60
	Keyboard or Auxiliary Input Device Check .....	61
	Memory Check .....	61
	Power System Check .....	61

# **Table of Contents**

Touchpad Check .....	62
Power-On Self-Test (POST) Error Message .....	63
Index of Error Messages .....	64
Index of Symptom-to-FRU Error Message .....	66
Intermittent Problems .....	70
Undetermined Problems .....	71
<b>Chapter 5 Jumper and Connector Locations</b>	<b>73</b>
Top View .....	73
Bottom View .....	74
<b>Chapter 6 FRU (Field Replaceable Unit) List</b>	<b>75</b>
<b>Appendix A Model Definition and Configuration</b>	<b>88</b>
Aspire 1350 series .....	88
<b>Appendix B Test Compatible Components</b>	<b>91</b>
Microsoft Windows XP (Home) Environment Test .....	92
<b>Appendix C Online Support Information</b>	<b>95</b>



# System Specifications

---

## Features

This computer was designed with the user in mind. Here are just a few of its many features:

### Performance

- AMD Athlon XP-M 2000+ ~ 3000+ processor
- VIA KN400 series
- 2 memory slots supporting 266/333MHz DDR, upgradeable to 2GB
- High capacity, Enhanced-IDE hard disk

### Display

- The 14.1" or 15.0" display panel provides a large viewing area for maximum efficiency and ease-of-use. The thin-film transistor (TFT) supports extended graphics array (XGA) resolution.
- 3D graphics support
- Supports simultaneous display between LCD and CRT display
- S-video for output to a television or display device that supports S-video input
- "Automatic LCD dim" feature that automatically selects the best setting for the display in order to conserve power
- Dual display capability

### Multimedia

- Built-in optical drive (CD-ROM, DVD-ROM, DVD/CD-RW combo, DVD-RW or DVD dual)
- 14.1" or 15.0" TFT XGA (1024\*768 resolution) panel
- Built-in stereo speakers
- Audio input and output jacks

### Connectivity

- Integrated 10/100Mbps Ethernet connection
- Built-in 56Kbps fax/data modem
- Four universal serial bus (USB 2.0) ports
- One IEEE 1394 port
- 802.11b and 802.11a+g wireless LAN and Bluetooth (manufacturing optional)

---

## Human-centric design

- All-in-one design (incorporating hard drive, optical drive and floppy disk drive)
- Rugged, yet extremely portable, construction
- Stylish appearance
- Full-size keyboard with four programmable launch keys
- Comfortable palm rest area with well-positioned touchpad

## Expansion

- Upgradeable hard disk and memory modules
- PC card slot enables a range of add-on options

## I/O Ports

- One type II or type III PC Card slot (PCMCIA or CardBus)
- One IEEE 1394 port
- One microphone-in jack
- One headphone-out jack
- One infrared port
- One DC-in jack
- One RJ-11 modem jack (V.90/V.92, 56K)
- One RJ-45 network jack (Ethernet 10/100Mbps)
- One S-video TV-out port
- One external display port
- One parallel port (ECP/EPP compliant)
- Four Universal Serial Bus (USB 2.0) ports

# System Block Diagram

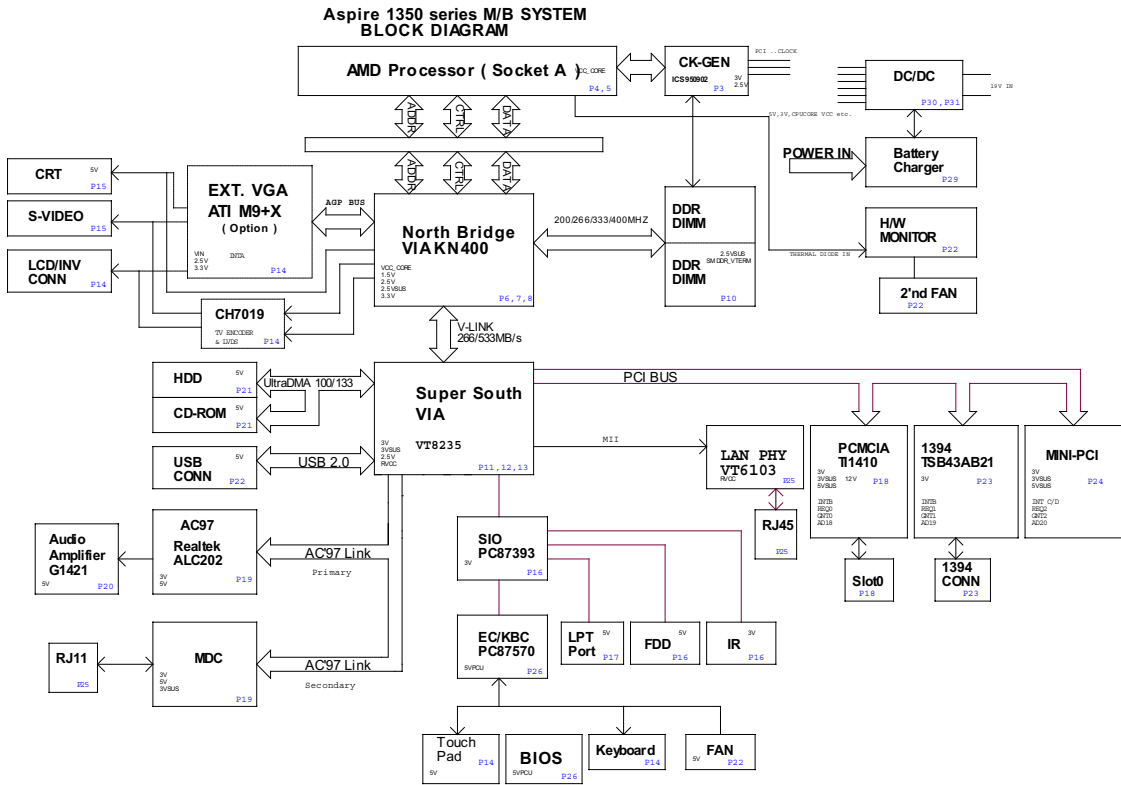

# Board Layout

## Top View

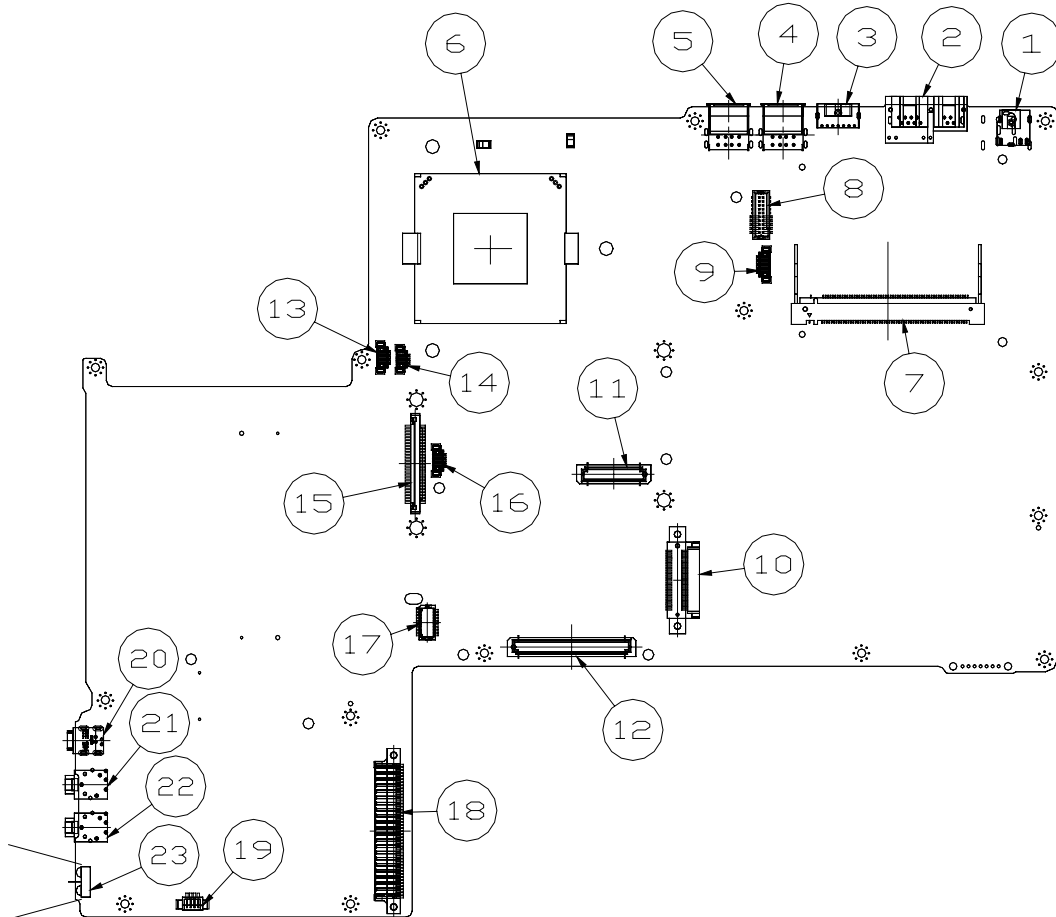

- |    |                             |    |                            |
|----|-----------------------------|----|----------------------------|
| 1  | DC-In                       | 13 | Heat Sink 4-pin Controller |
| 2  | RJ11 / RJ45                 | 14 | Heat Sink 3-pin Controller |
| 3  | S-Video                     | 15 | FDD Connector              |
| 4  | USB Connectors (*2)         | 16 | 4-In-1 Connector           |
| 5  | USB Connectors (*2)         | 17 | Touchpad Board Connector   |
| 6  | CPU Socket                  | 18 | HDD Connector              |
| 7  | Mini-PCI Socket             | 19 | Speaker Connector          |
| 8  | Launch Board Connector      | 20 | IEEE 1394 Connector        |
| 9  | LCD Inverter Connector      | 21 | Microphone-in Connector    |
| 10 | ODD Connector               | 22 | Headphone Connector        |
| 11 | VGA Board 60-pin Connector  | 23 | Infrared Connector         |
| 12 | VGA Board 120-pin Connector |    |                            |

# Bottom View

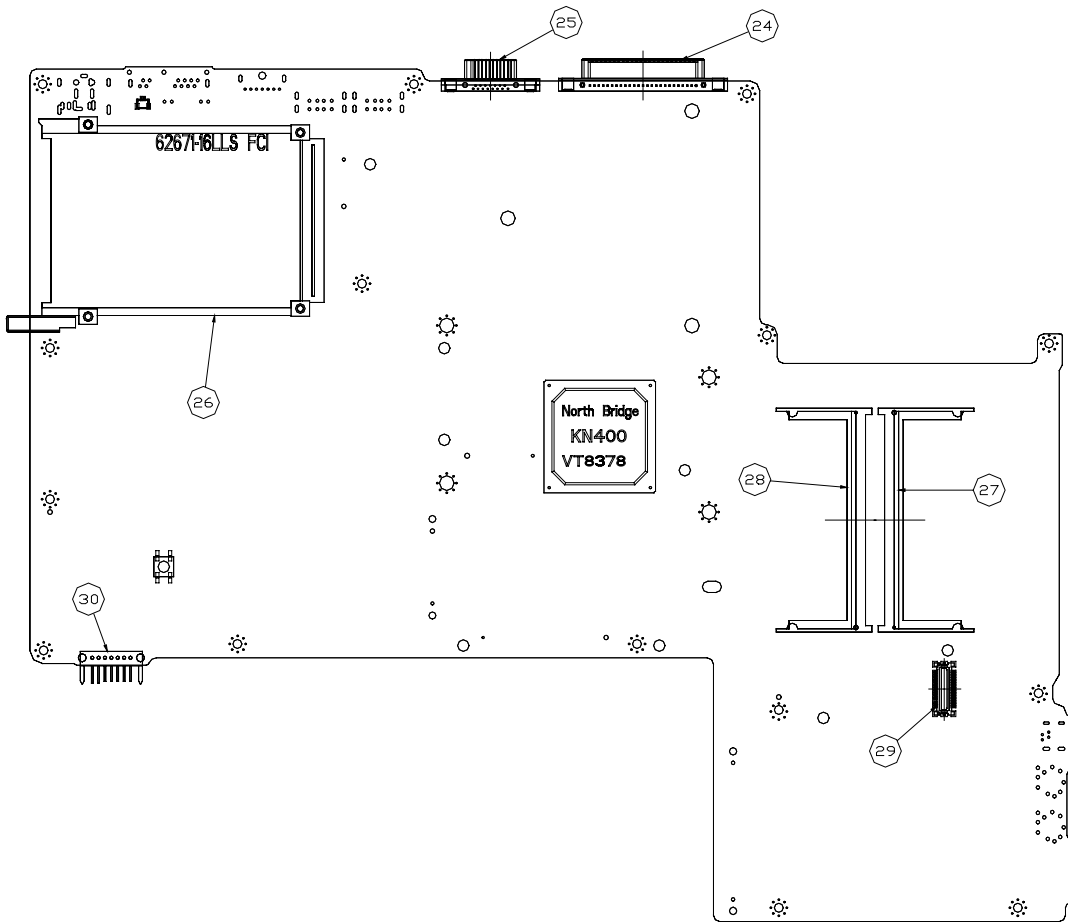

- |    |                            |    |                     |
|----|----------------------------|----|---------------------|
| 24 | Parallel Connector         | 28 | DDR Controller      |
| 25 | External Display Connector | 29 | MDC Board Connector |
| 26 | PCMCIA Connector           | 30 | Battery Connector   |
| 27 | DDR Connector              |    |                     |

# Outlook View

A general introduction of ports allow you to connect peripheral devices, as you would with a desktop PC.

## Front View



#	Item	Description
1	Display	Large liquid crystal display (LCD) provides visual output.
2	Power button	Turns the computer on and off.
3	Launch keys	4 buttons that can be programmed to start frequently used applications.
4	InviLink button (manufacturing option)	Enables or disables wireless LAN feature.
5	Bluetooth button (manufacturing option)	Enables or disables Bluetooth functionality.
6	Touchpad	Touch sensitive pad that functions like a computer mouse.
7	Click buttons & 4-way scroll key	Right and left buttons that provide the same functions as the buttons on a computer mouse. The scroll key scrolls the contents of a window up and down, as well as right and left.
8	Speakers	Speakers that deliver stereo audio output.
9	Palm rest	Provides a comfortable platform for your hands when typing on the keyboard.
10	Keyboard	Full-size keyboard for inputting typed data.
11	Status indicators	7 light emitting diodes (LED) that show the status of the computer and its components.
12	Latch	Locks and releases the lid.

**NOTE:** The wireless communication and Bluetooth buttons work for models with 802.11b, 802.11a+g wireless LAN and Bluetooth only.

## Left Panel

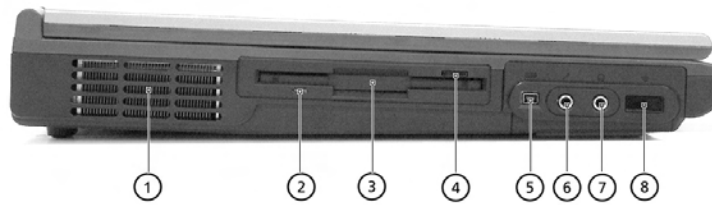

#	Item	Description
1	Ventilation slots	Enables the computer to stay cool, even after prolonged use.
2	Floppy activity indicator	LED (light emitting diode) that turns on and off when the floppy is activated.
3	Floppy disk drive / 4-in-1 card reader	Supports a standard 3.5" diskette or 4-in-1 card reader (manufacturing option).
4	Floppy disk eject button	Press the eject button to remove a diskette from the floppy disk drive.
5	IEEE 1394 port	Connects IEEE 1394 devices.
6	Microphone-in jack	Connects an external microphone for audio input.
7	Headphone jack	Connects headphones for audio output.
8	Infrared port	Interfaces with infrared devices (e.g., infrared printer, IR-aware computer).

## Right Panel

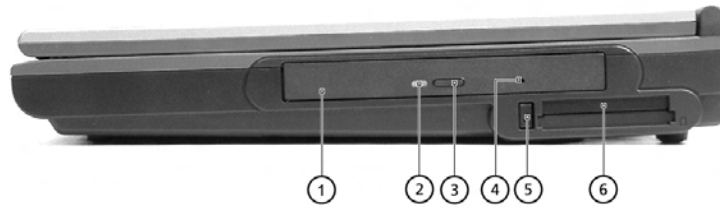

#	Item	Description
1	Optical drive	Depending on your model, the optical drive is one of the following: CD-ROM drive for reading CDs. DVD-ROM drive for reading CDs and DVDs. DVD/CD-RW combo drive for reading CDs and DVDs, and writing to CD-Rs and CD-RWs. DVD-RW drive for reading CDs, DVDs, DVD-R and DVD-RW, and writing to CD-Rs, CD-RWs, DVD-Rs and DVD-RWs. DVD dual for reading CDs, DVDs, DVD+/-R and DVD+/-RW, and writing to CD-Rs, CD-RWs, DVD+/-Rs and DVD+/-RWs.
2	Optical disc access indicator	LED (light emitting diode) that indicates when an optical disc is being read or written.
3	Optical drive eject button	Press the eject button to remove a disc from the optical drive.
4	Optical drive emergency eject hole	Used to eject an optical disc when the computer is turned off.
5	PC card eject button	Press the eject button to remove a PC card from the PC card slot.
6	PC card slot	The slot supports a standard Type II or Type III PC card (PCMCIA or CardBus).



## Rear Panel

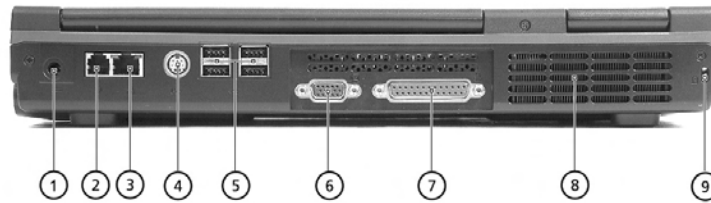

#	Item	Description
1	DC-in jack	Connects the AC adapter.
2	Modem jack	Connects the built-in fax/data modem to a phone line.
3	Network jack	Connects the computer to an Ethernet 10/100-based network.
4	S-video	Connects to a television or display device with S-video input.
5	USB ports	Four USB 2.0 ports for connecting USB devices.
6	External display port	Connects an external (VGA) display monitor.
7	Parallel port	Connects a parallel device, such as a printer.
8	Ventilation slots	Enable the computer to stay cool, even after prolonged use.
9	Kensington lock slot	For attaching a security connector.

## Bottom Panel

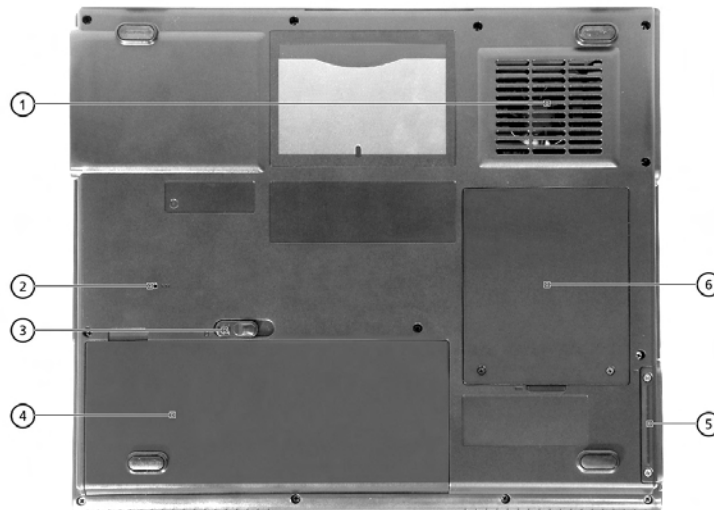

#	Item	Description
1	Ventilation slots	Enables the computer to stay cool, even after prolonged use.
2	Reset Switch	Forces the computer to shut down in the event of system lockup. <b>NOTE:</b> Any unsaved data will be lost.
3	Battery pack release latch	Slide and hold the latch, and then pull the battery to remove it from the unit.
4	Battery pack	The computer's removable battery.
5	Hard disk bay	Removable cover provides access to the computer's hard drive.
6	Memory compartment	Removable cover provides access to the memory slots for upgrading the computer's memory.

# Indicators

Your computer provides an array of six indicators located above the keyboard, in addition to two indicators positioned at the front of the palm rest area. These indicators show the status of the computer and its components.



The three indicators located above the keyboard provide the following status information:

Icon	Function	Description
	Caps lock	Lights when Caps Lock is activated.
	Num lock	Lights when Num Lock is activated.
	HDD	Lights when Hard Disk Drive is activated.

**NOTE:** The keypad lock must be turned on to use the embedded numeric keypad.

The four indicators located at the front of the unit provide the following status information:

Icon	Function	Description
	Power mode	Steady green - power on Flashing orange - standby mode Orange - hibernation mode
	Battery mode	Green - fully charged Flashing orange - being charged Orange - low on power
	Wireless LAN mode	Lights to indicate status of wireless LAN (optional) communication.
	Bluetooth mode	Lights to indicate that Bluetooth (optional) is enabled.

# Keyboard

The keyboard features full-size keys with an embedded keypad, separate cursor control keys, two Windows keys, and twelve function keys (hot keys).

## Special keys

### Lock keys



The computer features three lock keys, each with its own status indicator light.

Lock Key	Description
Caps Lock	When Caps Lock is on, all alphabetic characters are typed in uppercase. Toggle on and off by pressing the Caps Lock key on the left side of the keyboard.
Num lock	When Num Lock is on, the embedded numeric keyboard can be used. Toggle on and off by pressing the Fn + F11 keys simultaneously.
Scroll lock	When Scroll Lock is on, the screen toggles up or down one line at a time when the up and down cursor control keys are pressed. <b>Note:</b> Scroll Lock doesn't work in all applications. Toggle on and off by pressing the Fn + F12 keys simultaneously.

## Embedded Keypad

The embedded keypad functions like a desktop numeric keypad. It is indicated by small blue numbers and on the applicable keys.



To use the the embedded numeric keys, toggle the Num Lock on by pressing the Fn + F11 keys simultaneously.









With the embedded keypad turned on, the following actions are possible:

Desired Access	Num Lock On	Num Lock On
Number keys on embedded keypad	Type numbers using embedded keypad in the normal way.	
Cursor-control keys on embedded keypad	Hold down the <b>SHIFT</b> key while using the cursor keys on the embedded keypad.	Hold Fn key while using cursor-control keys.
Main keyboard keys	Hold down the Fn key while typing letters using the embedded keypad keys. Simultaneously press the <b>SHIFT</b> key for for capital letters.	Type letters in the normal way.

## Windows Keys

The keyboard has two keys that perform Windows-specific functions.



Key	Description
Windows logo key	Pressed alone, this key has the same effect as clicking on the Windows Start button; it launches the Start menu. It can also be used with other keys to provide a variety of functions:
	 + Tab (Activates the next Taskbar button)
	 + E (Opens the My Computer window)
	 + F1 (opens Help and Support)
	 + F (opens the Find: All Files dialog box)
	 + M (minimizes all windows)
	 +  + M (undoes the minimize all windows action)
	 + R (opens the Run dialog box)













Key	Description
Application key 	This key has the same effect as clicking the right mouse button; it opens the application's context menu.

## Hotkeys

Using the Fn key with another key creates a hot key, providing a quick and convenient method for controlling various functions.

To use a hot key, first hold down the Fn key. Next, press the second key in combination. Finally, release both keys.



Hot Key	Function	Function
Fn + 	Hot key help	Displays help on hot keys.
Fn + 	Setup	Access the computer's configuration utility.
Fn + 	Power management scheme toggle	Switches the power management scheme used by the computer (function available if supported by operating system).
Fn + 	Sleep	Puts the computer in Sleep mode.
Fn + 	Display toggle	Switches display output between the display screen, external monitor (if connected) and both the display screen and external monitor.
Fn + 	Screen blank	Turns the display screen backlight off to save power. Press any key to return.
Fn + 	Touchpad toggle	Turns the internal touchpad on and off.
Fn + 	Speaker toggle	Turns the speakers on and off.
Fn + 	Volume up	Increases the speaker volume.
Fn + 	Volume down	Decreases the speaker volume.
Fn + 	Brightness up	Increases the screen brightness.
Fn + 	Brightness down	Decreases the screen brightness

**NOTE:** When activating hotkeys, press and hold the **Fn** key before pressing the other key in the hotkey combination.

---

## Euro key

Your computer supports the new Euro currency character. First, hold down the Alt Gr key, and then press the Euro key.



## Keyboard Ergonomics

The wide palm rest area provides a comfortable platform for your hands when typing on the keyboard. The ergonomic design enables you to adopt a relaxed, yet very efficient, typing style.

# Touchpad

The built-in touchpad is a PS/2-compatible pointing device that senses movement on its surface. This cursor responds to your finger movements on the touchpad. In addition, the two click buttons provide the same functionality as a computer mouse, while the scroll key enables easy up and down scrolling in documents and web pages.

The touchpad is located in the middle of the palm rest area, providing maximum comfort and efficiency.



## Touchpad Basics

Use the touchpad as follows:

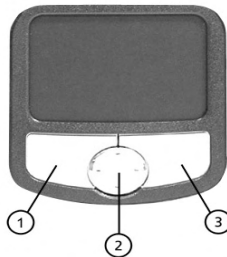

- ❑ Slide your finger over the surface of the touchpad to control the movement of the cursor. Tap the touchpad to perform selection and execution functions.
- ❑ Press the left (1) and right (3) buttons to perform selection and execution functions, just as you would use the buttons on a computer mouse.
- ❑ Use the scroll key (2) to scroll through long documents and web pages. Press the top of the key to scroll up, and the bottom to scroll down; left to scroll left, and right to scroll right.

Function	Left Button	Righ Button	4-Way Scroll Key	Tap
Execute	Click twice quickly			Tap twice quickly
Select	Click once			Tap once
Drag	Click and hold. Then slide your finger across the touchpad to drag the cursor over the selection.			Tap twice quickly. On the second tap, slide your finger across the touchpad to drag the cursor over the selection.
Access context menu		Click once		
Scroll			Click and hold the up/ down/ left/ right button	

**NOTE:** Keep your fingers, as well as the surface of the touchpad dry and clean. The touchpad is sensitive to your finger movements: the lighter your touch, the better the response. Tapping hard will not increase the touchpad's responsiveness.







---

## Launch Keys

Located at the top of the keyboard are six buttons, in addition to the power button. These buttons are called launch keys. They are designated as key 1, key 2, key 3, key 4, key 5 and key 6 from right to left. By default, key 1 is used to launch the email application and key 2 is used to launch the Internet browser. Keys 3 and 4 start the Launch Manager application. Key 5 and 6 are used to enable the Wireless LAN and Bluetooth features. The first four launch keys can be set by the user.

To see the launch keys, run the Acer Launch Manger.



Launch key	Icon	Description
Email		Launches your email application.
Web browser		Launches your Internet browser
P1		User-programmable
P2		User-programmable
InviLink		Enables your 802.11b / 802.11a+g Wireless LAN (optional)
Bluetooth		Enables your Bluetooth (optional)

# Hardware Specifications and Configurations

## Processor

Item	Specification
CPU type	AMD Athlon XP-M DTR(2000+ ~ 3000+) FSB 266MHz
CPU package	OPGA
CPU core voltage	1.3V ~ 1.65V

## BIOS

Item	Specification
BIOS vendor	Phoenix
BIOS Version	3A10
BIOS ROM type	Flash ROM
BIOS ROM size	512KB
BIOS package	PLCC
Supported protocols	ACPI 1.0b, APM 1.2, PC Card 95, AC97 2.1, EPP/IEEE 1284, ECP/IEEE 1284 1.7 & 1.9, PCI 2.2, PnP 1.0a, DMI 2.0, USB, DDC-2B, ODD bootable, Windows keyboard Microsoft Simple Boot Flag
BIOS password control	Set by setup manual

## Second Level Cache

Item	Specification
Cache controller	Built-in CPU
Cache size	512KB
1st level cache control	Always enabled
2st level cache control	Always enabled
Cache scheme control	Fixed in write-back

## System Memory

Item	Specification
Memory controller	VIA KN400 series
Onboard memory size	0MB
DIMM socket number	2 sockets (4 banks)
Supports memory size per socket	1024MB (1GB)
Supports maximum memory size	2048MB (2GB)
Supports DIMM type	DDR SDRAM (Double Data Rate-Synchronous Dynamic Random Access Memory)
Supports DIMM Speed	266/333MHz
Supports DIMM voltage	2.5V
Supports DIMM package	200-pin SODIMM
Memory module combinations	You can install memory modules in any combinations as long as they match the above specifications.

## Memory Combinations

Slot 1	Slot 2	Total Memory
256 / 512 / 1024MB	0 MB	256 / 512 / 1024MB
256 / 512 / 1024MB	256MB	512 / 768 / 1280MB
256 / 512 / 1024MB	512MB	768 / 1024 / 1536MB
256 / 512 / 1024MB	1024MB	1280 / 1536 / 2048MB

Above table lists some system memory configurations. You may combine DIMMs with various capacities to form other combinations.

## LAN Interface

Item	Specification
Chipset	VIA LAN controller
Supports LAN protocol	10/100 Mbps
LAN connector type	RJ45
LAN connector location	Rear side

## Modem Interface

Item	Specification
Chipset	Agere Scorpio +CSP1037B
Fax modem data baud rate (bps)	14.4K
Data modem data baud rate (bps)	56K
Supports modem protocol	V.90 / V.92 MDC
Modem connector type	RJ11
Modem connector location	Rear side

## Floppy Disk Drive Interface

Item	Specification
Vendor & model name	Panasonic JU-226A 243FC
Floppy Disk Specifications	
Media recognition	2DD (720KB)      2HD (1.44MB)
Sectors/track	9                      18
Tracks	80                     80
Rotational speed (RPM)	300                   300
Read/write heads	2
Encoding method	MFM / FM
Power Requirement	
Input Voltage (V)	+5V +/- 10%

## Hard Disk Drive Interface

Item	Specification						
Vendor & Model Name	TOSHIBA 20G(MK20 23GAS), TITAN	IBM 20G(IC25N 020ATMR0 4), CASCADE	IBM 30G(IC25N 030ATMR0 4), CASCADE	TOSHIBA 30GB(MK3 021GAS) NEPTUNE	HGST 40GB (IC25N040 ATMR04) CASCADE	TOSHIBA 40GB(MK4 021GAS) NEPTUNE	TOSHIBA 60GB(MK6 021GAS) NEPTUNE
Capacity (MB)	20000	20000	30000	30000	40000	40000	60000

### Hard Disk Drive Interface

Item	Specification						
Bytes per sector	512	512	512	512	512	512	512
Data heads	2	1	2	2	2	4	4
Drive Format							
Disks	1	1	1	1	1	2	2
Spindle speed (RPM)	4200 RPM	4200 RPM	4200RPM	4200RPM	4200RPM	4200RPM	4200RPM
Performance Specifications							
Buffer size	2048KB	2048KB	2048KB	2048KB	2048KB	2048KB	2048KB
Interface	ATA-5	ATA-5	ATA-5	ATA-5	ATA-5	ATA-5	ATA-5
Max. media transfer rate (disk-buffer, Mbytes/s)	350	350	350	350	350	350	350
Data transfer rate (host~buffer, Mbytes/s)	100 MB/ Sec. Ultra DMA mode-2	100 MB/ Sec. Ultra DMA mode-2	100 MB/ Sec. Ultra DMA mode-2	100 MB/ Sec. Ultra DMA mode-2	100 MB/ Sec. Ultra DMA mode-2	100 MB/ Sec. Ultra DMA mode-2	100 MB/ Sec. Ultra DMA mode-2
DC Power Requirements							
Voltage tolerance	5V(DC) +/- 5%	5V(DC) +/- 5%	5V(DC) +/- 5%	5V(DC) +/- 5%	5V(DC) +/- 5%	5V(DC) +/- 5%	5V(DC) +/- 5%

### DVD-ROM Interface

Item	Specification	
Vendor & model name	DVD-ROM 8X QSI SDR-083	
Performance Specification	With CD Diskette	With DVD Diskette
Transfer rate (KB/sec)	Sustained: Max 3.6Mbytes/sec	Sustained: Max 10.8Mbytes/sec
Data Buffer Capacity	128 KBytes	
Interface	IDE/ATAPI	
Applicable disc format	DVD: DVD-5, DVD-9, DVD-10, DVD-R (3.95G) CD: CD-Audio, CD-ROM (mode1 and mode 2), CD-ROM XA(mode 2 form 1 and form 2), CD-I (mode 2 form 1 and form 2), CD-I Ready, CD-I Bridge CD-WO, CD-RW, Photo CD, Video CD, Enhanced Music CD, CD-TEXT	
Loading mechanism	Soft eject (with emergency eject hole)	
Power Requirement		
Input Voltage	+5 V +/- 5 %	

### Audio Interface

Item	Specification
Audio Controller	AC'97 Codec
Audio onboard or optional	Built-in
Mono or Stereo	Stereo
Resolution	20 bit stereo Digital to Analog converter 18 bit stereo Analog to Digital converter
Compatibility	Microsoft PC98/PC99, AC97 2.1
Mixed sound source	Microphone, CD, AUX
Voice channel	8/16-bit, mono/stereo
Sampling rate	44.1 kHz
Internal microphone	No

## Audio Interface

Item	Specification
Internal speaker / Quantity	Yes
Supports PnP DMA channel	DMA channel 0 DMA channel 1
Supports PnP IRQ	IRQ9

## Video Interface

Item	Specification
Chip vendor	VIA
Chip name	KN400 (Integrated with Northbridge)
Supports ZV (Zoomed Video) port	No
Graph interface	Inside KN400 (Accelerated Graphics Port) Bus
Maximum resolution (LCD)	1024*768
Maximum resolution (CRT)	1600*1200

## Video Memory

ItemResolution	Specification
Fixed or upgradeable	Fixed
Video memory size	64MB (Share system memory)

## Parallel Port

Item	Specification
Parallel port controller	NS87393
Number of parallel port	1
Location	Rear side
Connector type	25-pin D-type connector, in female type
Parallel port function control	Always Enabled
Supports ECP/EPP/Bi-directional (PS/2 compatible)	Yes (set by BIOS setup)
Optional ECP DMA channel (in BIOS Setup)	DMA channel 1 and 3
Optional parallel port I/O address (in BIOS Setup)	378h
Optional parallel port IRQ (in BIOS Setup)	IRQ7

## USB Port

Item	Specification
USB Compliancy Level	1.1/2.0
EHCI	USB 2.0
Number of USB port	4
Location	Rear panel
Serial port function control	Always Enabled

## PCMCIA Port

Item	Specification
PCMCIA controller	Ti PCI 1410A

## PCMCIA Port

Item	Specification
Supports card type	Type II/III
Number of slots	One
Access location	Right side
Supports ZV (Zoomed Video) port	No ZV support
Supports 32 bit CardBus	Yes (IRQ5)

## System Board Major Chips

Item	Controller
System core logic	VIA KN400 + VT8235
Super I/O controller	NS PC87393
Audio controller	RealTek ALC202
Video controller	VIA KN400
Hard disk drive controller	VIA VT8235
Keyboard controller	NS PC87570
RTC	VIA VT8235
IEEE 1394	Ti TSB43AB21

## Keyboard

Item	Specification
Keyboard controller	NS PC87570
Keyboard vendor & model name	Sunrex
Total number of keypads	86/87-key
Windows keys	Yes
Internal & external keyboard work simultaneously	Yes

## Battery

Item	Specification
Vendor & model name	Simplo
Battery Type	Li-ion
Pack capacity	4400mAH
Cell voltage	1.85 V/cell
Number of battery cell	8
Package configuration	4 cells in series, 2 series in parallel
Package voltage	Li-ion 14.8V

DCAC LCD inverter

Item	Specification		
Vendor & model name	Quanta 3HYA1 IV0008		
Input voltage (V)	8(min.)	-	20(max.)
Input current (mA)	-	-	520(max.)
Output voltage (Vrms, no load)	-	660(typ.)	-
Output voltage frequency (kHz)	55(min.)	56(typ.)	58(max.)
Output Current/Lamp	Iout(Min.)	3.0mA ± 0.5mA	Vadj=0V
	Iout(Max.)	6.0mA ± 0.5mA	Vadj=3.3V

**NOTE:** DC-AC inverter is used to generate very high AC voltage, the support to LCD CCFT backlight user, and is also responsible for the control of LCD brightness. Avoid touching the DC-AC inverter area while the system is turned on.

LCD

Item	Specification	
Vendor & model name	QDI QD141X1LH03 Samsung LTN141X8L04 AU B141XN04	LG LP150X2-A296 Sharp LP150X1 LH82 AU B150XN01
Mechanical Specifications		
LCD display area (diagonal, inch)	14.1	15.0
Display technology	TFT	TFT
Resolution	XGA (1024x768)	XGA (1024x768)
Supports colors	262K	262K
Optical Specification		
Brightness control	keyboard hotkey	keyboard hotkey
Contrast control	No	No
Suspend/Standby control	Yes	Yes
Electrical Specification		
Supply voltage for LCD display (V)	3.3	3.3
Supply voltage for LCD backlight (Vrms)	690	690

AC Adapter

Item	Specification
Vendor & model name	Li-Shin 90W 0202C1990 (WPFC) 3P Lite-on 90W PA 1900-05QA (WPFC) 3P
Input Requirements	
Maximum input current (A, @90Vac, full load)	1.4A @ 100Vac 1.15A @ 180Vac
Nominal frequency (Hz)	47 - 63
Frequency variation range (Hz)	47 - 63
Nominal voltages (Vrms)	100 - 240

## AC Adapter

Item	Specification
Inrush current	The maximum inrush current will be less than 150Ap-p when the adapter is connected to 115Vac(60Hz) and 230Vac(50Hz) respectively.
Efficiency	It should provide an efficiency of 83% minimum, when measured at maximum load under 115V(60Hz).
Output Ratings	
DC output voltage	+18.0V ~ 20.0V including the effects of line voltage variation, load current, ripple and noise
Noise + Ripple	400mVp-p (20MHz bandwidth) for resistor load
Output current	0 ~ 4.74A
Input rated voltage	100 / 240V
Input current	1.5A @ 90Vac, 1.15A @ 180Vac
Dynamic Output Characteristics	
Turn-on delay time	5 sec. (Max)
Hold up time	10ms min. (115 Vac, input full load)
Over Voltage Protection (OVP)	29 V
Short circuit protection	Output can be shorted without damage
Electrostatic discharge (ESD)	15kV (at air discharge) 8kV (at contact discharge)
Dielectric Withstand Voltage	
Primary to secondary	3000Vac (4242Vdc) 10mA for 1 second
Leakage current	100uA max (240Vac, 60Hz)
Regulatory Requirements	Internal filter meets; 1. FCC class B requirements. 2. VDE 243/1991 class B requirements. 3. CISPR 22 Class B requirements. 3. VCCI class II requirements.

## Power Management

Power Saving Mode	Phenomenon
<p><b>Standby Mode</b> Waiting time specified by the System Standby value or the operating system elapses without any system activity. Or When the computer is about to enter Hibernation mode (e.g. during a battery-low condition), but the Hibernation file is invalid or not present.</p>	The Sleep indicator lights up
<p><b>Hibernation Mode</b> When customized functions for power management are set to Hibernation and the corresponding action is taken.</p>	All power shuts off
<p><b>Display Standby Mode</b> Keyboard, built-in touchpad, and an external PS/2 pointing device are idle for a specified period.</p>	The display shuts off
<p><b>Hard Disk Standby Mode</b> Hard disk is idle within a specified period of time</p>	Hard disk drive is in standby mode. (spindle turned-off)



## Environmental Requirements

Item	Specification
<b>Temperature</b>	
Operating	0 ~ +35 °C
Non-operating	-20 ~ +60 °C (unpacked)
Non-operating	Non (storage package)
<b>Humidity</b>	
Operating	0% to 90% RH, non-condensing
Non-operating	20% to 90% RH, non-condensing (unpacked)
Non-operating	Non (storage package)
<b>Vibration</b>	
Operating (unpacked)	5 ~ 500Hz: 1.0Grms (random)
Non-operating (unpacked)	5 ~ 500Hz: 2.16Grms (random)
Non-operating (packed)	5 ~ 500Hz: 2.16Grms (random)

## Mechanical Specification

Item	Specification
Dimensions	334mm (W) * 286.5mm (D) * 42mm (Front) / 49mm (Rear)
Weight	3.6 kg (7.92 lbs) for 14.1" LCD with DVD module 3.72 kg (8.2 lbs) for 15.0" LCD with DVD/CD-RW combo module
I/O Ports	One IEEE1394 port, One Microphone in jack, One Headphone jack, One Infrared port, One PCMCIA (Type II or Type III) slot, Four USB port, One RJ-11 jack for modem, One RJ-45 jack for Ethernet, One S-video port, One VGA (external monitor) port, One Parallel port (ECP/EPP compliant), One DC-in jack for AC adapter
Drive Bays	One
Material	Plastic
Indicators	Power Mode LED, Battery Charge, Caps Lock, Num Lock, Scroll Lock, FDD activity, HDD activity, ODD activity
Switch	Power

## I/O Address Map

I/O Address	Function
0000-000F	DMA controller
0020-0021	Programmable interrupt controller
0040-0043	System timer
0060, 0064	Keyboard controller NS PC87570 chip select
0061	System speaker
0062, 0066	ACPI-Compliant Embedded Controller
0070-0075	System CMOS/real time clock
0081-008F, 0092-0092	DMA controller
00A0-00A1	Programmable interrupt controller
00C0-00DF	DMA controller
00F0-00FF	Numeric data processor
0170-0177, 0376	2nd EIDE device (optical drive) select
01F0-01F7, 03F6	1st EIDE device (hard drive) select
0274-0277, 0279, 0A79	ISAPNP Read Data Port
02F8-02FF	IrDA FIR

I/O Address Map

I/O Address	Function
0378-037F, 0778-077F	ECP Printer Port (LPT1)
03B0-03BB, 03C0-03DF	Video Controller
03F0-03F5, 03F7	Standard Floppy Disk Controller
1000-10FF	Ethernet Controller
1400-14FF	Audio Controller
1800-18FF	Modem

IRQ Assignment Map

Interrupt Channel	Function(Hardware)
IRQ00	System timer
IRQ01	Keyboard
IRQ03	IrDA FIR
IRQ04	USB, VGA, LAN
IRQ05	IEEE 1394, CardBus, USB
IRQ06	Floppy
IRQ07	Parallel Port
IRQ08	CMOS/RTC
IRQ09	AC'97 Modem, Audio, USB
IRQ10	SCI
IRQ11	Enhance PCI to USB Host Controller
IRQ12	Alps pointing device
IRQ13	Numeric data processor
IRQ14	1st EIDE device (hard disk)
IRQ15	2nd EIDE device (optical drive)

DMA Channel Assignment

DMA Channel	Function(Hardware)
DRQ0	Reserved
DRQ1	ECP Print Port
DRQ2	Floppy
DRQ3	IrDA FIR
DRQ4	DMA controller
DRQ5	Reserved
DRQ6	Reserved
DRQ7	Reserved

# System Utilities

## BIOS Setup Utility

The BIOS Setup Utility is a hardware configuration program built into your computer's BIOS (Basic Input/Output System).

Your computer is already properly configured and optimized, and you do not need to run this utility. However, if you encounter configuration problems, you may need to run Setup. Please also refer to Chapter 4 Troubleshooting when problem arises.

To activate the BIOS Utility, press **F2** during POST (when "Press <F2> to enter Setup" message is prompted on the bottom of screen).

Press **F2** to enter setup. Press <F12> during POST to enter multi-boot menu. In this menu, user can change boot device without entering BIOS SETUP Utility.

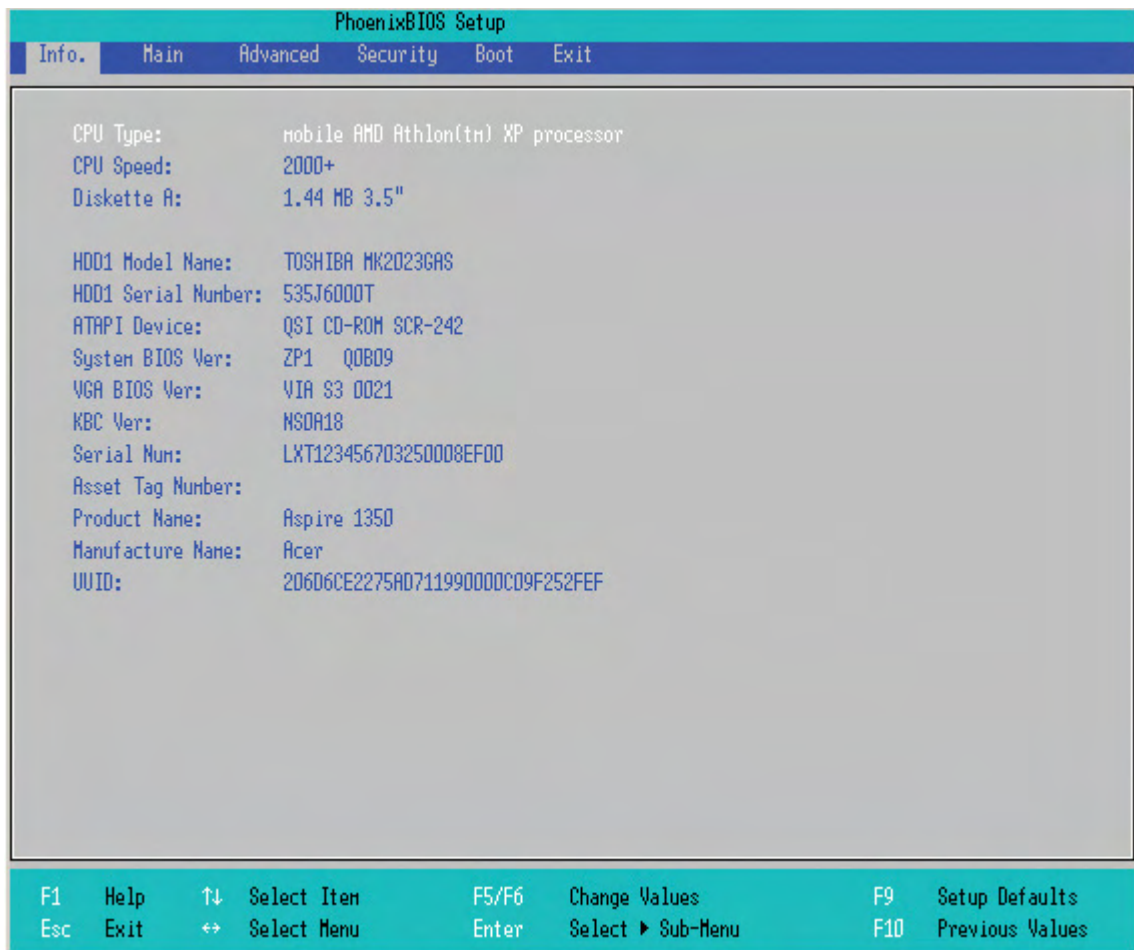











---

## Navigating the BIOS Utility

There are six menu options: Info., Main, Advanced, Security, Boot, and Exit.

Follow these instructions:

- To choose a menu, use the cursor left/right keys (   ).
- To choose a parameter, use the cursor up/down keys (   ).
- To change the value of a parameter, press  or  .
- While the item has sub-items, press  to expand this item.
- Press  while you are in any of the menu options to go to the Exit menu.
- In any menu, you can load default settings by pressing  . You can also press  to save any changes made and exit the BIOS Setup Utility.

**NOTE:** You can change the value of a parameter if it is enclosed in square brackets. Navigation keys for a particular menu are shown on the bottom of the screen. Help for parameters are found in the Item Specific Help part of the screen. Read this carefully when making changes to parameter values.

This menu provides you the information of the system.

## Information

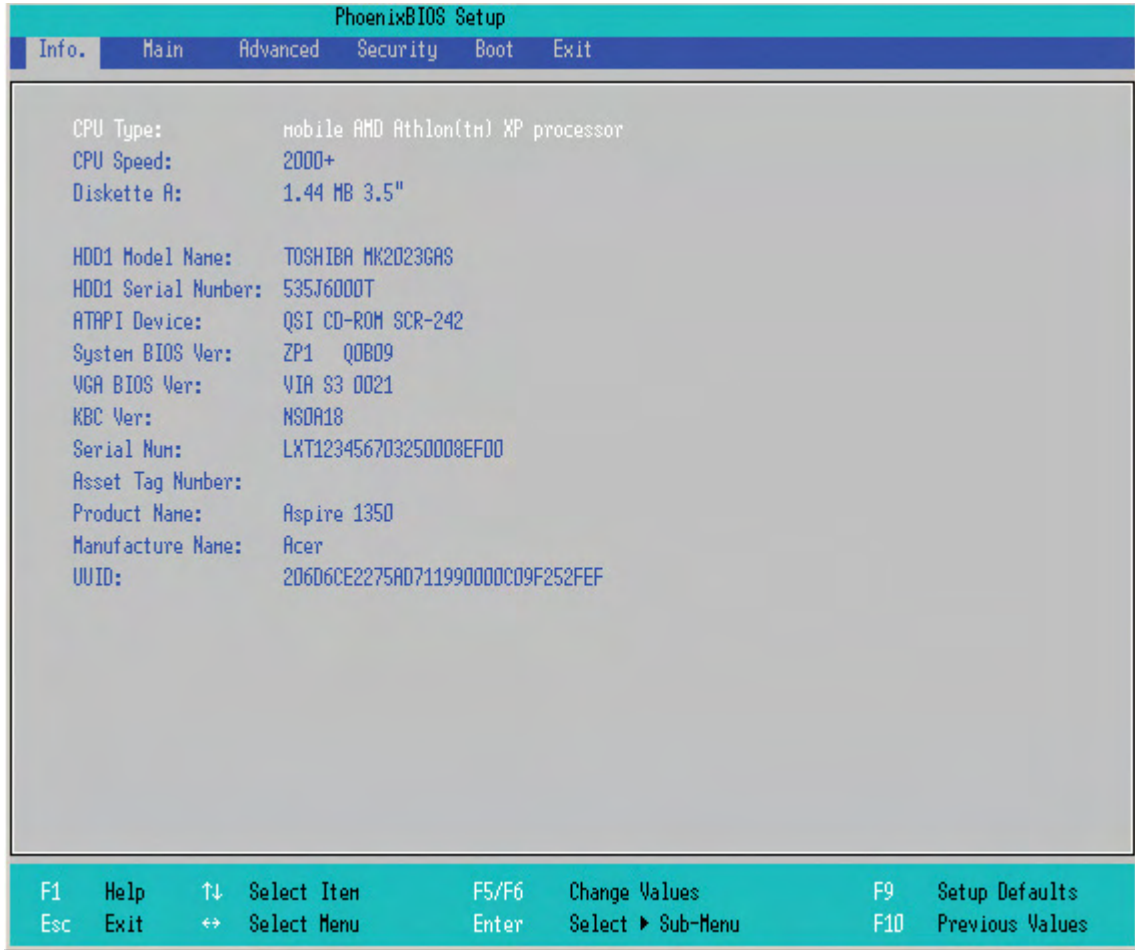

Parameter	Description
CPU Type	Displays the CPU type information.
CPU Speed	Displays the CPU speed.
Diskette A	Displays the floppy drive type information.
HDD1 Model Name	IDE device model name information will be retrieved automatically during system boot.
HDD1 Serial Number	IDE device serial number information will be retrieved automatically during system boot.
ATAPI Device	ATAPI device model name information will be retrieved automatically during system boot.
System BIOS Ver	Displays the system BIOS version.
VGA BIOS Ver	Displays the VGA BIOS version.
KBC Ver	Displays the keyboard controller firmware version.
Serial Num	Displays the system serial number.
Asset Tag Number	N/A
Product Name	Displays the product name.
Manufacture Name	Displays the Acer company.
UUID Number	Displays the UUID (Universal Unique Identifier) string = 32 bytes.

# Main

The Main screen displays a summary of your computer hardware information, and also includes basic setup parameters. It allows the user to specify standard IBM PC AT system parameters.

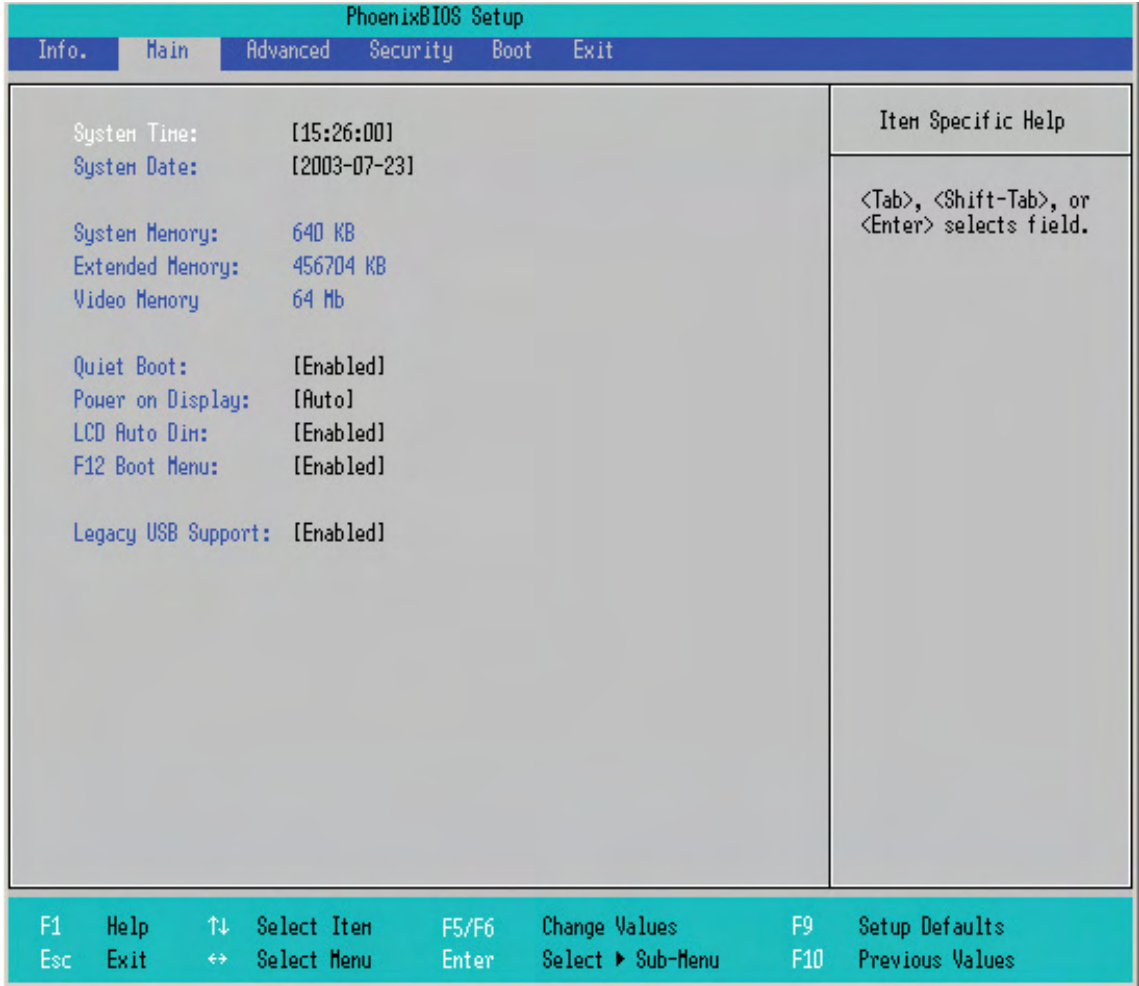

**NOTE:** The screen above is for reference only. Actual values may differ.

The table below describes the parameters in this screen. Settings in **boldface** are the default and suggested parameter settings.

Parameter	Description	Format/Option
System Time	Sets the system time.	Format: HH:MM:SS (hour:minute:second) System Time
System Date	Sets the system date.	Format: MM/DD/YYYY (month/day/year) System Date
System Memory	This field reports the memory size of the system. The user can not change the memory setting. This is display-only field. Memory size is fixed to 640 KB	
Extended Memory	This field reports the memory size of the extended memory in the system. The user can not change the memory setting. This is display-only field. Extended Memory size=Total memory size -1MB	
Video Memory	The total amounts of memory for VGA. The user can not change the memory setting. This is display-only field.	
Quiet Boot	Determines if Logo will be displayed or not; shows diagnostic screen is disabled or enabled. Enabled: Logo is displayed, and diagnostic screen is disabled. Disabled: Logo is not displayed, and diagnostic screen is enabled.	Option: <b>Enabled</b> or Disabled
Power on display	Selects display device. Auto: During power process, the system will detect if any display device is connected on external video port. If any external display device is connected, the power on display will be in CRT (or projector) only mode. Otherwise it will be in LCD only mode. Both: Simultaneously enable both the integrated LCD screen and the system's external video port (for an external CRT or projector).	Option: <b>Auto</b> or Both
LCD Auto Dim	Determines if the system will automatically dim the LCD brightness in order to save power when AC is not present.	Option: <b>Enabled</b> or Disabled
F12 Boot Menu	Selects the F12 boot menu function.	Option: <b>Enabled</b> or Disabled
Legacy USB Support	Selects legacy USB support.	Option: <b>Enabled</b> or Disabled

**NOTE:** The sub-items under each device will not be shown if the device control is set to disable or auto. This is because the user is not allowed to control the settings in these cases.

## Advanced

The Advanced menu screen contains parameters involving your hardware devices. It also provides advanced settings of the system.

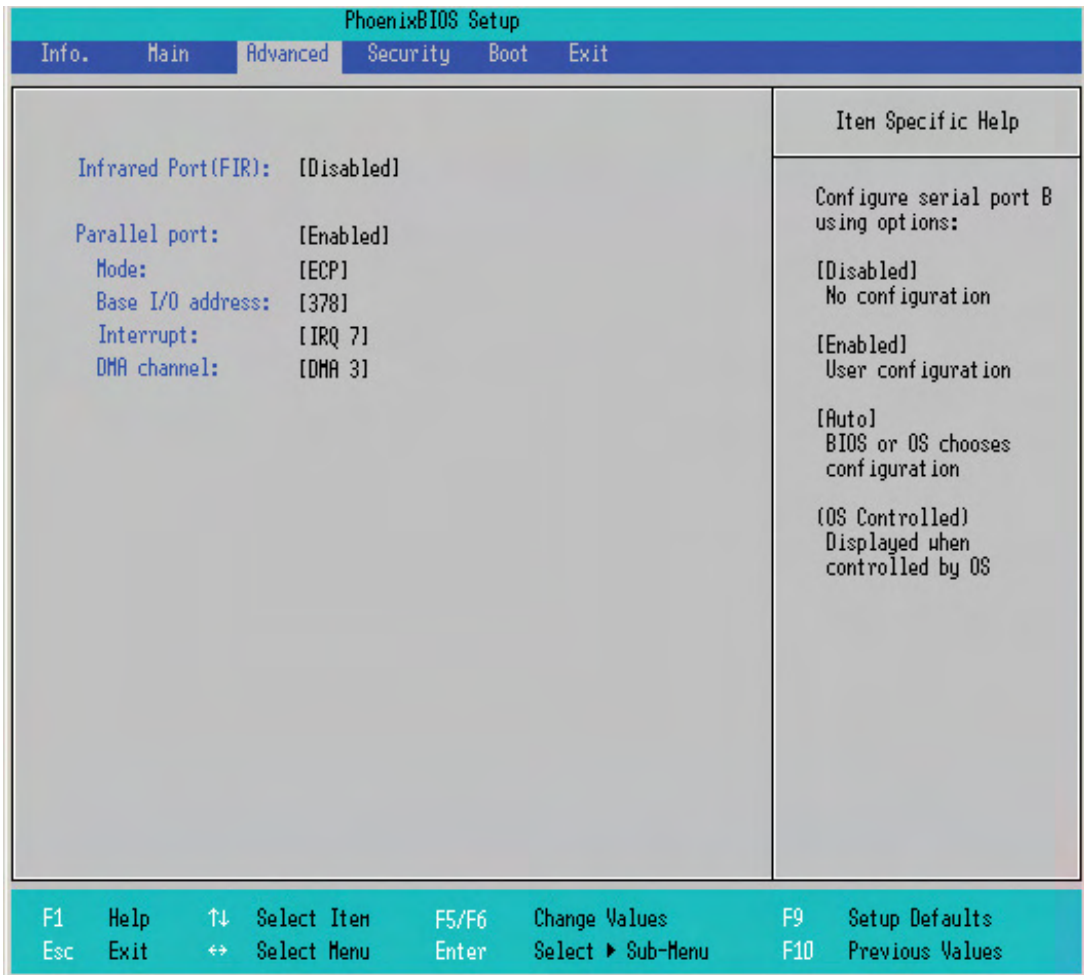

The table below describes the parameters in the screen. Settings in **boldface** are the default and suggested parameter settings.

Parameter	Description	Options
Infrared Port	Selects serial port address and IRQ.	<b>Disabled</b> /Enabled/Auto
Parallel Port	Selects parallel port address and IRQ.	<b>Enabled</b> /Disabled/Auto
Mode	Allows user to specify the operating mode of parallel port. <b>Note:</b> Shows up if Parallel Port is set to Auto or Enabled.	<b>ECP</b> , EPP, Bi-directional, or Output only
Base I/O address	Allows the user to choose the resource if the 'Parallel Port' is set to 'Enable'. <b>Note:</b> Shows up if Parallel Port is set to Enabled.	<b>378h</b> /278h
Interrupt	Sets the interrupt request of the parallel port.	<b>IRQ7</b> /IRQ5
DMA channel	Sets a DMA channel for the printer to operate in ECP mode. <b>Note:</b> Shows up if Mode is set to ECP.	<b>DMA3</b> /DMA1



# Security

The Security screen contains parameters that help safeguard and protect your computer from unauthorized use.

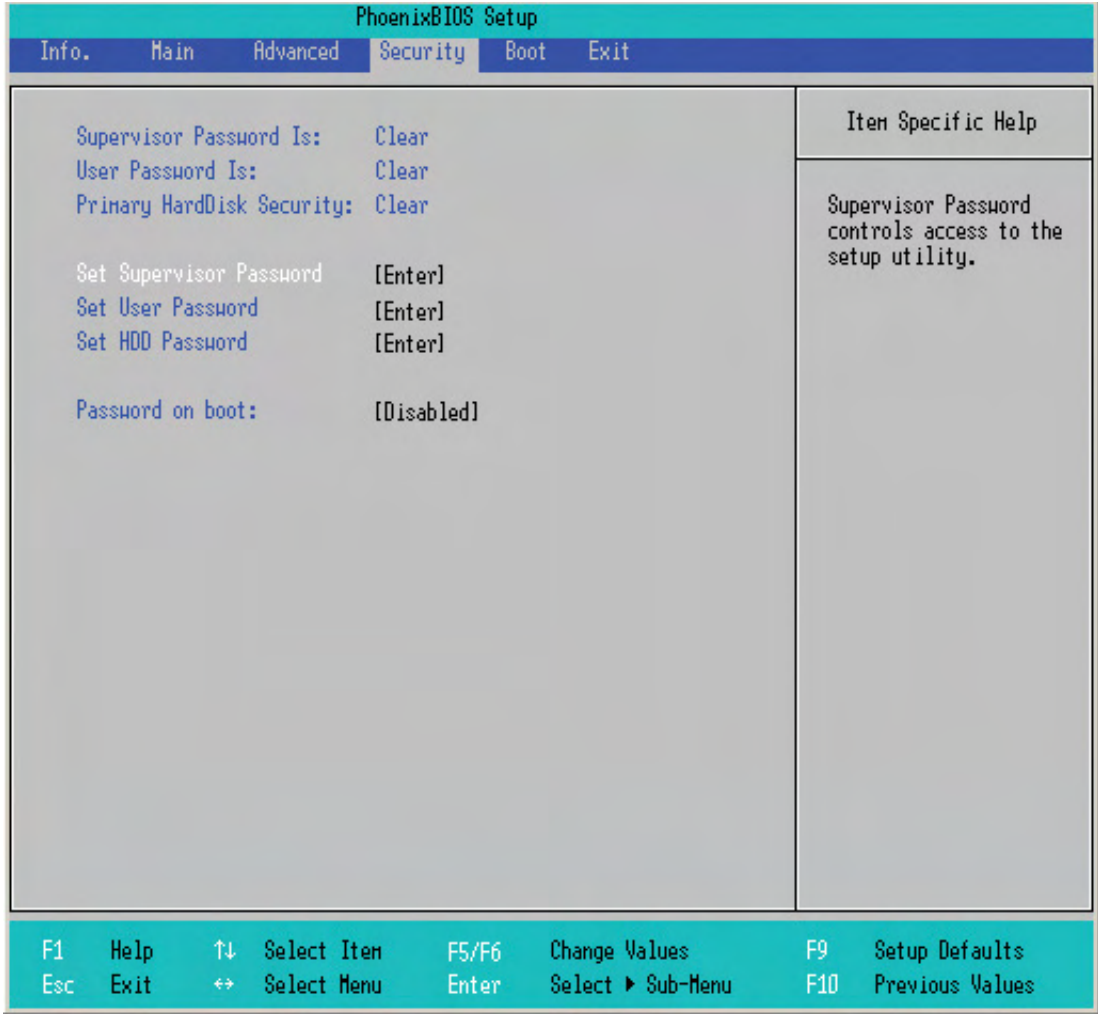



The table below describes the parameters in this screen. Settings in **boldface** are the default and suggested parameter settings.

Parameter	Description	Option
Supervisor Password is	Shows the setting of the Supervisor password.	<b>Clear</b> or Set
User Password is	Shows the setting of the user password.	<b>Clear</b> or Set
Primary Harddisk Security	Shows the setting of the Primary Harddisk Security.	<b>Clear</b> or Set
Set Supervisor Password	Press Enter to set the supervisor password. When set, this password protects the BIOS Setup Utility from unauthorized access.	
Set User Password	Press Enter to set the user password. When set, this password protects the BIOS Setup Utility from unauthorized access.	
Set HDD Password	This feature is available to user when Supervisor password is set. Password can be written on HDD only when Supervisor password or user password is set and password on HDD is set to enabled. Supervisor Password is written to HDD only when Supervisor password is being set. User password is written to HDD when both passwords are set. When both Supervisor and user password are present, both passwords can unlock the HDD.	
Password on Boot	Defines whether a password is required or not while the events defined in this group happened. The following sub-options are all requires the Supervisor password for changes and should be grayed out if the user password was used to enter setup.	<b>Disabled</b> or Enabled

**NOTE:** When you are prompted to enter a password, you have three tries before the system halts. Don't forget your password. If you forget your password, you may have to return your notebook computer to your dealer to reset it.

## Setting a Password

Follow these steps as you set the user or the supervisor password:

- Use the  and  keys to highlight the Set Supervisor Password parameter and press the  key. The Set Supervisor Password box appears:



Set Supervisor Password

Enter New Password [            ]

Confirm New Password [            ]

- Type a password in the "Enter New Password" field. The password length can not exceeds 8 alphanumeric characters (A-Z, a-z, 0-9, not case sensitive). Retype the password in the "Confirm New Password" field.



**IMPORTANT:** Be very careful when typing your password because the characters do not appear on the screen.

- Press .
- After setting the password, the computer sets the User Password parameter to "Set".
- If desired, you can opt to enable the Password on boot parameter.
- When you are done, press  to save the changes and exit the BIOS Setup Utility.



---

## Removing a Password



Follow these steps:

1. Use the  and  keys to highlight the Set Supervisor Password parameter and press the  key. The Set Password box appears:



Set Supervisor Password		
Enter current password	[	]
Enter New Password	[	]
Confirm New Password	[	]

2. Type the current password in the Enter Current Password field and press  .
3. Press  twice **without** typing anything in the Enter New Password and Confirm New Password fields. The computer then sets the Supervisor Password parameter to “Clear”.
4. When you have changed the settings, press  to save the changes and exit the BIOS Setup Utility.

## Changing a Password

1. Use the  and  keys to highlight the Set Supervisor Password parameter and press the  key. The Set Password box appears:

Set Supervisor Password		
Enter current password	[	]
Enter New Password	[	]
Confirm New Password	[	]

2. Type the current password in the Enter Current Password field and press  .
3. Type a password in the Enter New Password field. Retype the password in the Confirm New Password field.
4. Press  . After setting the password, the computer sets the User Password parameter to “Set”.
5. If desired, you can enable the Password on boot parameter.
6. When you are done, press  to save the changes and exit the BIOS Setup Utility.

If the verification is OK, the screen will display as following.

Setup Notice
Changes have been saved.
[ continue ]

The password setting is complete after the user presses .

---

If the current password entered does not match the actual current password, the screen will show you the Setup Warning.

Setup Warning  
Invalid password  
Re-enter Password  
[ continue]

If the new password and confirm new password strings do not match, the screen will display the following message.

Setup Warning  
Password do not match  
Re-enter Password

# Boot

This menu allows the user to decide the order of boot devices to load the operating system. Bootable devices includes the distette drive in module bay, the onboard hard disk drive and the CD-ROM/DVD-ROM in module bay.

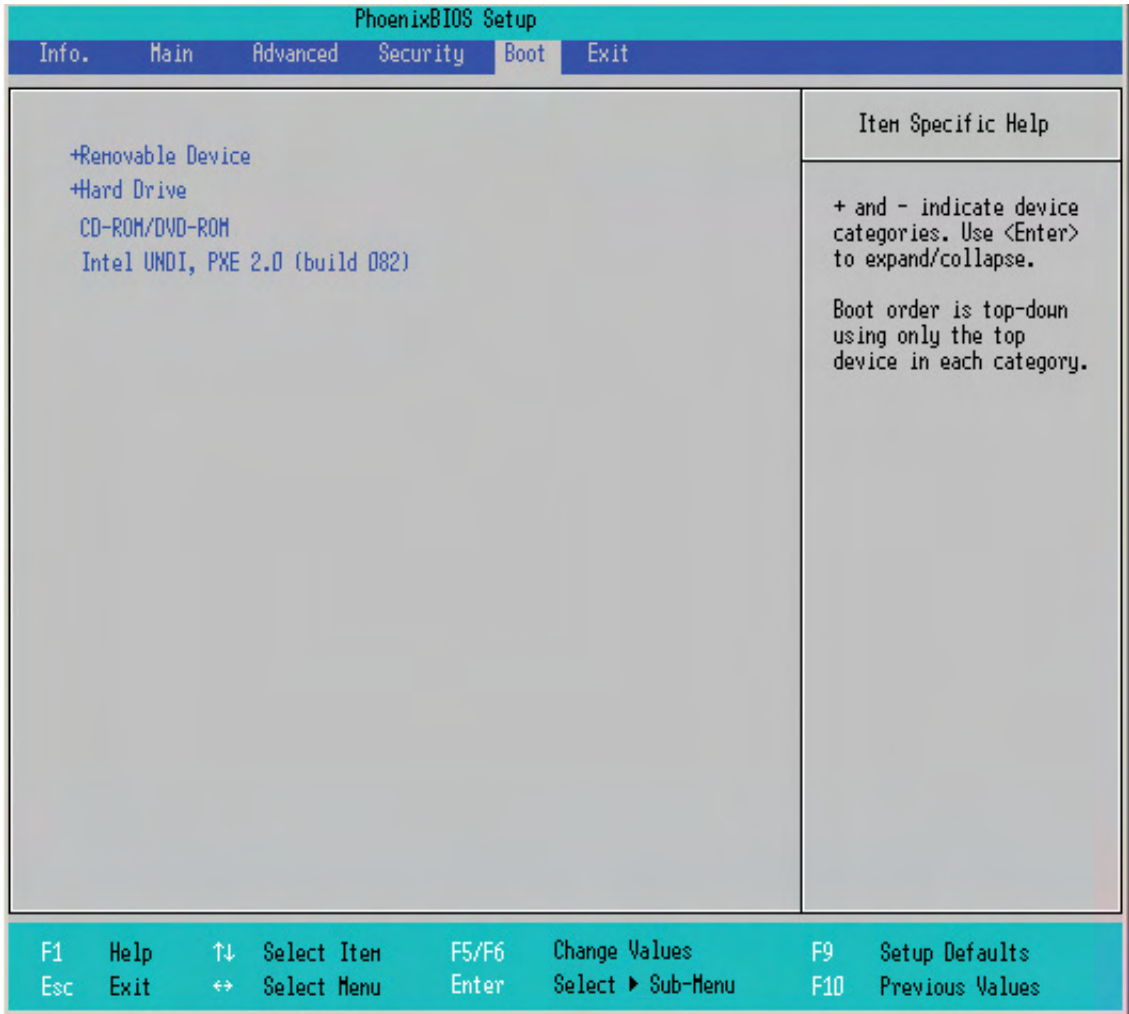

## Exit

The Exit screen contains parameters that help safeguard and protect your computer from unauthorized use.

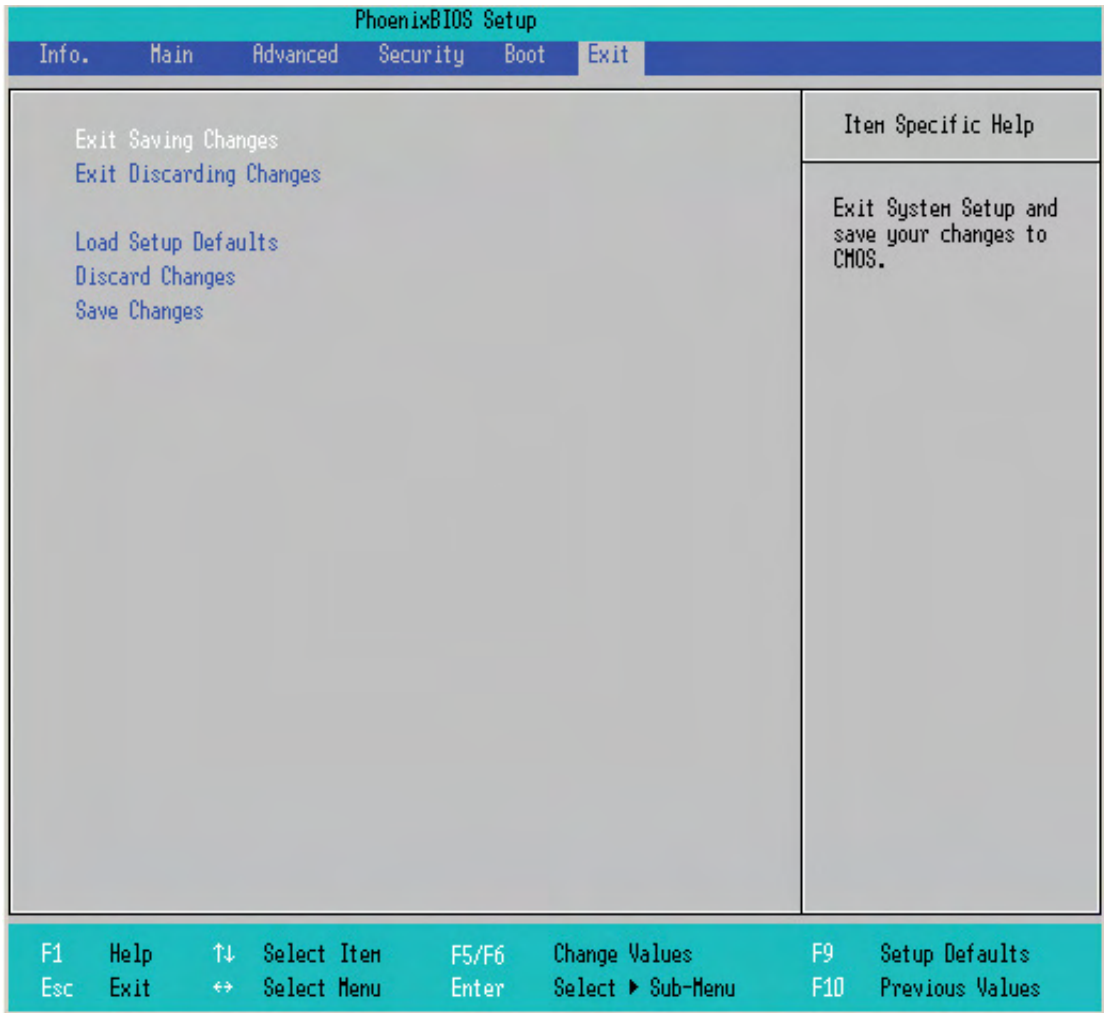

The table below describes the parameters in this screen.

Parameter	Description
Exit Saving Changes	Exit System Setup and save your changes to CMOS.
Exit Discarding Changes	Exit utility without saving setup data to CMOS.
Load Setup Default	Load default values for all SETUP item.
Discard Changes	Load previous values from CMOS for all SETUP items.
Save Changes	Save Setup Data to CMOS.

---

## BIOS Flash Utility

The BIOS flash memory update is required for the following conditions:

- New versions of system programs
- New features or options
- Restore a BIOS when it becomes corrupted.

Use the Phlash utility to update the system BIOS flash ROM.

**NOTE:** If you do not have a crisis recovery diskette at hand, then you should create a **Crisis Recovery Diskette** before you use the Phlash utility.

**NOTE:** Do not install memory-related drivers (XMS, EMS, DPMS) when you use the Phlash.

**NOTE:** Please use the AC adaptor power supply when you run the Phlash utility. If the battery pack does not contain enough power to finish BIOS flash, you may not boot the system because the BIOS is not completely loaded.

Follow the steps below to run the Phlash.

1. Prepare a bootable diskette.
2. Copy the Phlash utilities to the bootable diskette.
3. Then boot the system from the bootable diskette. The Phlash utility has auto-execution function.

## System Diagnostic Diskette

This diagnostic diskette is for the Acer Aspire 1350 series notebook machine. However, system diagnostic utility is not ready as service CD released. Acer HQ CSD will upload the utility to CSD website as soon as it is ready.





# Machine Disassembly and Replacement

---

This chapter contains step-by-step procedures on how to disassemble the notebook computer for maintenance and troubleshooting.

To disassemble the computer, you need the following tools:

- Wrist grounding strap and conductive mat for preventing electrostatic discharge
- small Philips screwdriver
- flat head screwdriver
- Philips screwdriver
- nut screwdriver
- tweezers

**NOTE:** The screws for the different components vary in size. During the disassembly process, group the screws with the corresponding components to avoid mismatch when putting back the components. When you remove the stripe cover, please be careful not to scrape the cover.

---

# General Information

## Before You Begin

Before proceeding with the disassembly procedure, make sure that you do the following:

1. Turn off the power to the system and all peripherals.
2. Unplug the AC adapter and all power and signal cables from the system.
3. Remove the battery pack.

# Disassembly Procedure Flowchart

The flowchart on the succeeding page gives you a graphic representation on the entire disassembly sequence and instructs you on the components that need to be removed during servicing. For example, if you want to remove the system board, you must first remove the keyboard, then disassemble the inside assembly frame in that order.

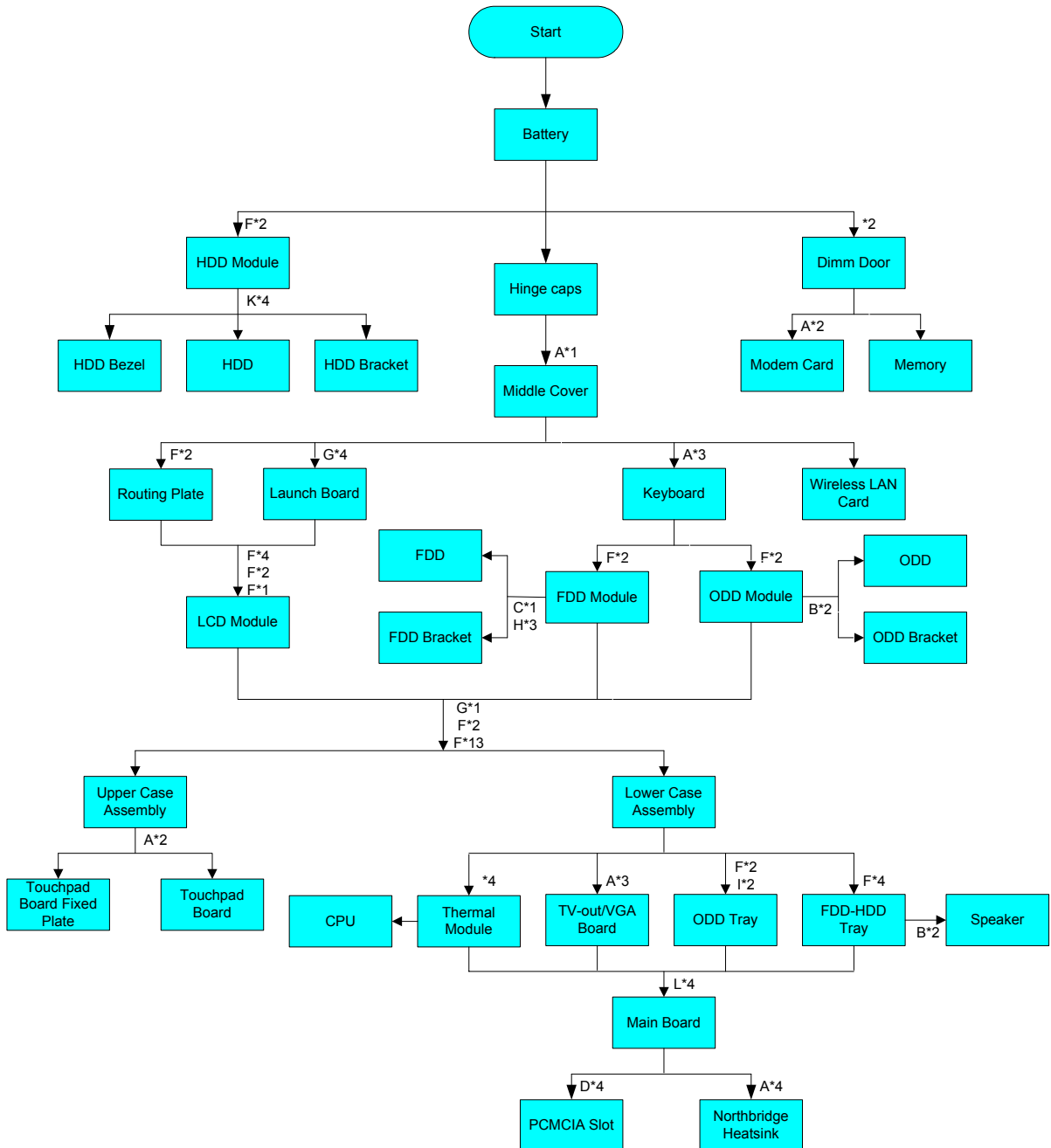

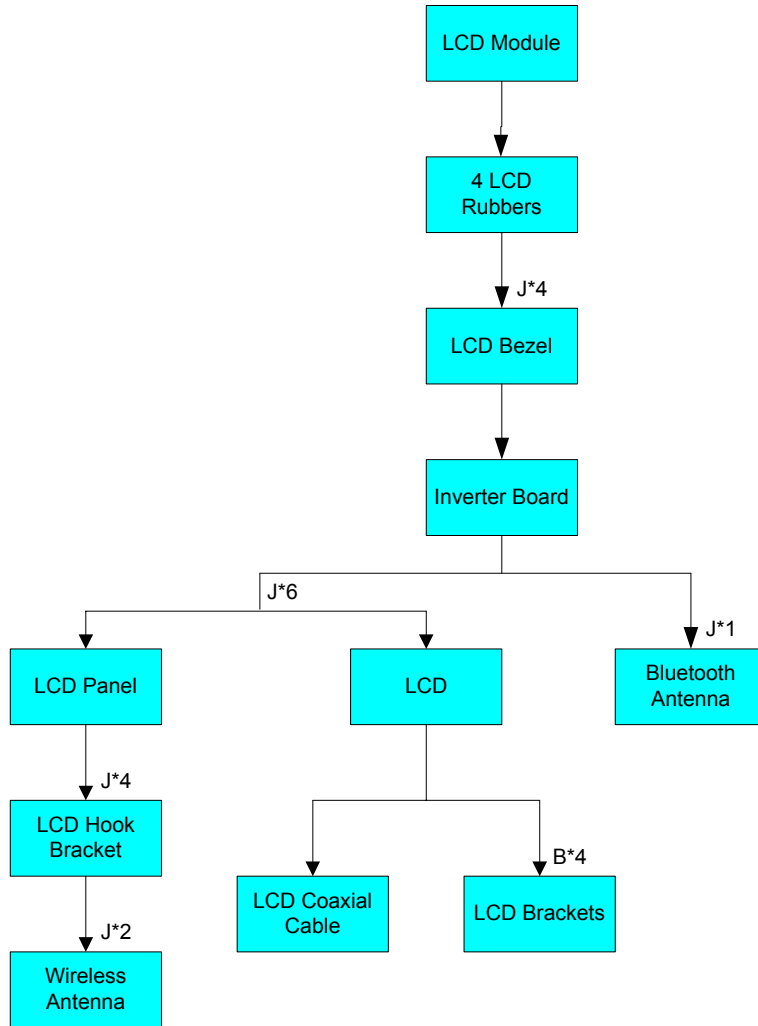

**Screw List**

Item	Description
A	SCREW M2.5*4L-BZN-NYLOK
B	SCREW M2*3L-NI-NYLOK
C	SCREW M2.0*2.0-BZN
D	SCREW M2*4L NI-NYLOK
E	SCREW M2*7L-NI-NYLOK
F	SCREW M2.5*7L-BNI-NYLOK
G	SCREW M2.5*3L-BNI-NYLOK
H	SCREW M2.5*3L-NI-NYLOK
I	SCREW M2.5*5L-NI-NYLOK
J	SCREW M2.5*6L-NI-NYLOK
K	SCREW M3*2.8L-NI-NYLOK
L	SCREW NUT-I/O

---

## Removing the Battery Pack

1. Slide the battery latch.
2. Then remove the battery pack.

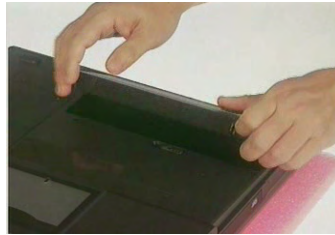

---

## Removing the Memory/MDC (Modem/Bluetooth)/HDD Module

1. Remove the two screws holding the DIMM door.
2. Remove the DIMM door.
3. Pop out the memory then take out the memory.



4. Remove the two screws that secure the MDC(modem or modem/Bluetooth combo) board.
5. Remove the MDC board then disconnect the MDC cable and Bluetooth antenna.

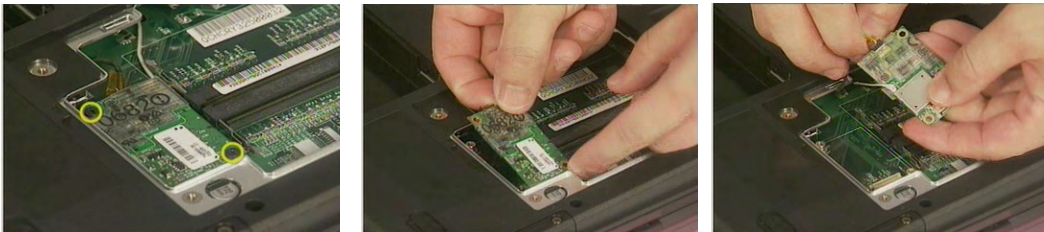

6. Remove the two screws holding the HDD bezel(cover).
7. Then pull out the HDD module from the notebook computer.



---

## Removing the Keyboard/ODD Module/FDD Module

1. Remove the right hinge cap.
2. Then remove the left hinge cap.
3. Remove one screw holding the middle cover.



4. Use a flat screwdriver to remove the middle cover carefully.

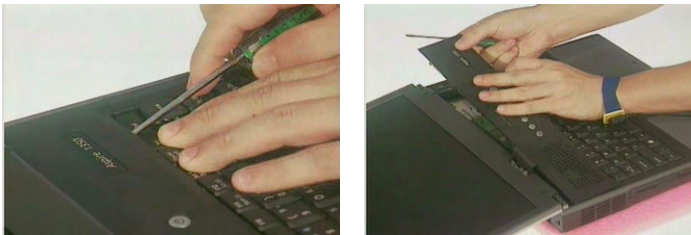

5. Remove the three screws that hold the keyboard. Then turn over the keyboard.
6. Disconnect the keyboard connector then remove the keyboard.



7. Remove the two screws that secure the ODD module.
8. Then take out the ODD module.

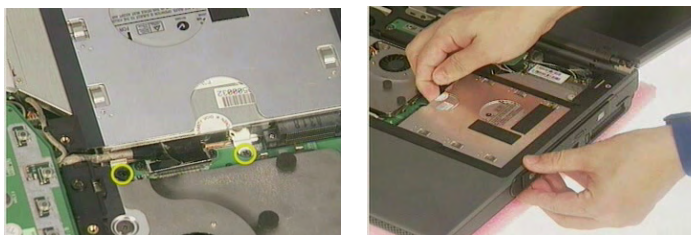

- 
9. Remove the two screws that secure the FDD module.
  10. Disconnect the FDD cable.
  11. Then take out the ODD module.

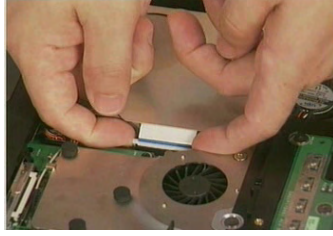
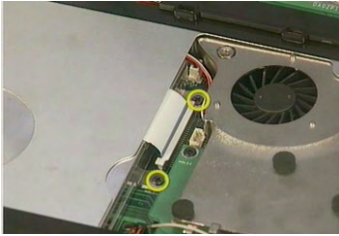



## Disassembling the Main Unit

1. Remove the four screws that secure the launch board.
2. Then take the launch board off the main unit.
3. Disconnect the lid switch cable.

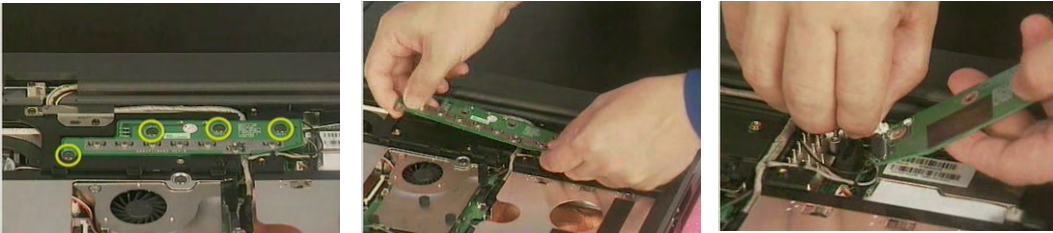

4. Disconnect the wireless LAN antenna.
5. Pop out the wireless LAN card.

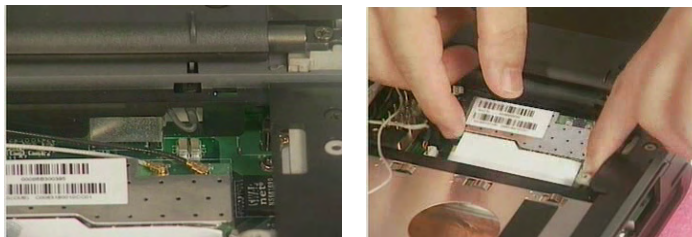

6. Disconnect the inverter cable from the main unit.
7. Remove the two screws that secure the LCD coaxial cable.
8. Then disconnect the LCD coaxial cable.

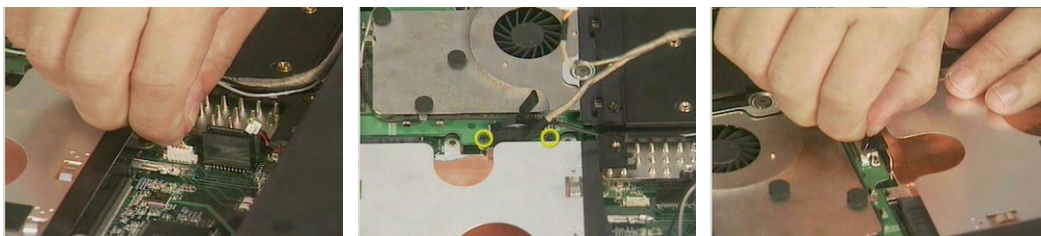

9. Remove the two screws holding the routing(routing) plate.
10. Then remove the routing(routing) plate.

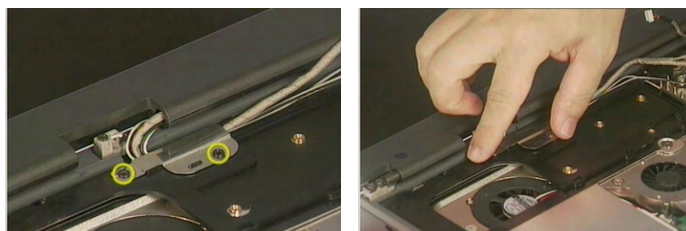

11. Pull out the Bluetooth antenna carefully.
12. Take out the Bluetooth antenna as picture shows.

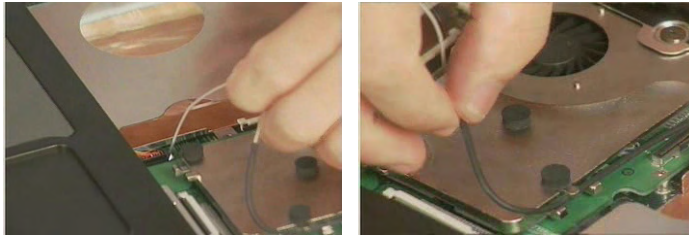

13. Remove one screw that secures the ground cable.



14. Remove the two screws that secure the LCD module on one side.
15. Then remove another two screws on the other side.
16. Detach the entire LCD module.

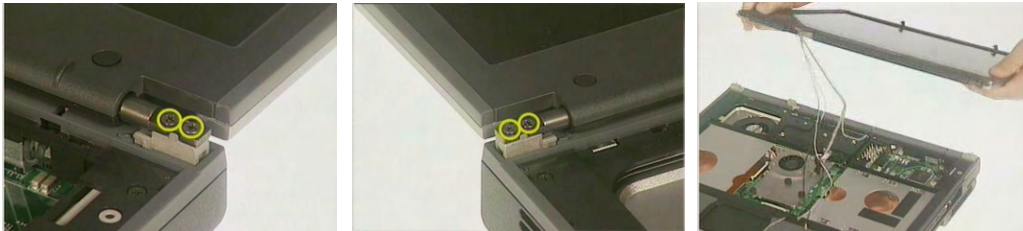

17. Remove one screw as picture shows in order to detach upper case assembly.
18. Then remove the thirteen screws on the bottom panel.

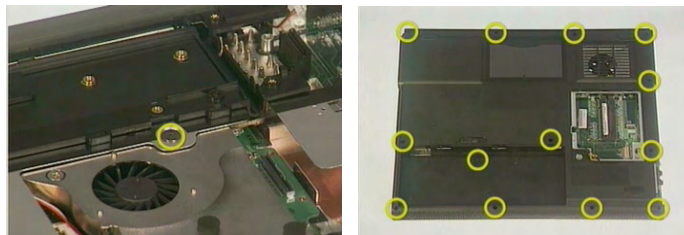

19. Remove one screw on the rear on one side.
20. Then remove another screw on another side.
21. Detach the upper case assembly carefully.

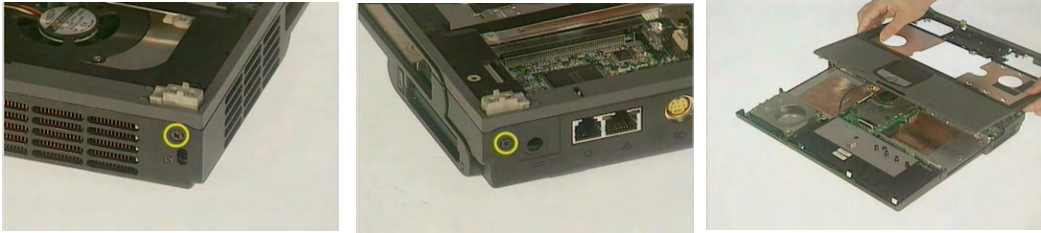

22. Disconnect the touchpad board cable(black) from the main board.
23. Disconnect the touchpad board cable(black) from the touchpad board(scroll board).
24. Disconnect the touchpad cable(white) from the the touchpad board(scroll board).

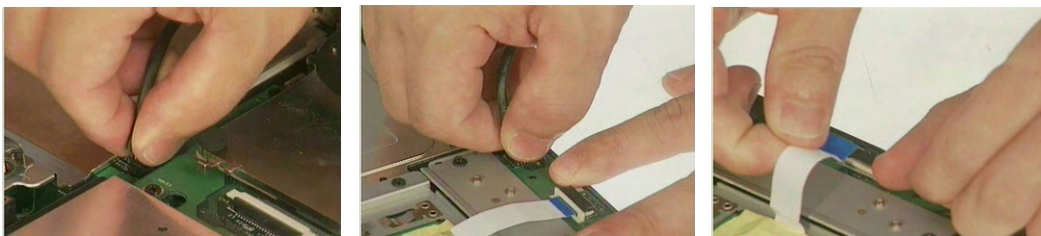

25. Remove the two screws that secure the touchpad board(scroll board).
26. Then take out the touchpad board(scroll board).

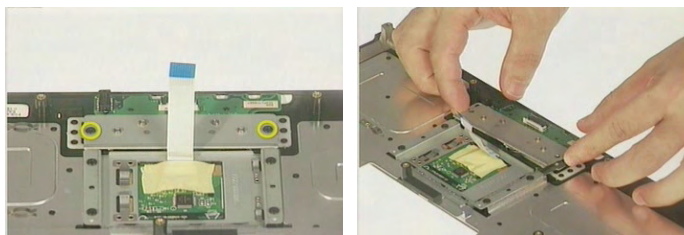

27. Remove the four screws that secure the thermal module according to order.
28. Then remove the thermal module as picture shows.
29. Disconnect the two fan cables then take out the thermal module.

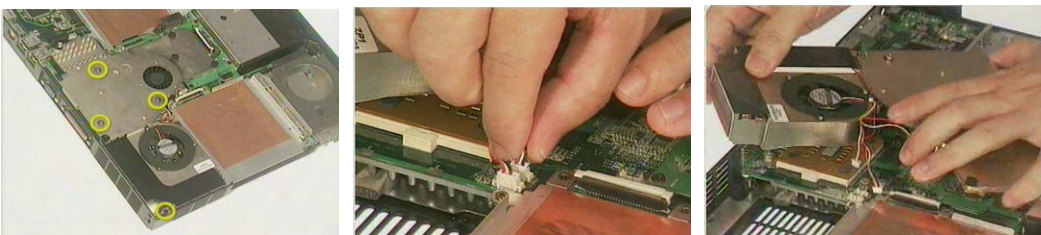



30. Remove the four screws holding the ODD tray.

31. Then remove the ODD tray.

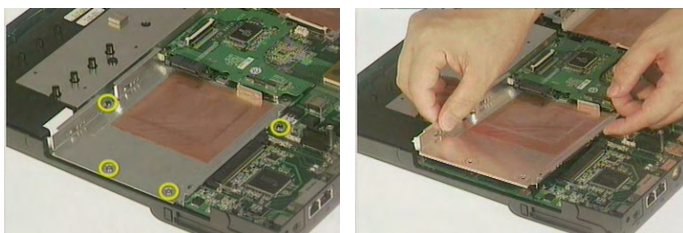

32. Remove the four screws holding the FDD-HDD tray.

33. Then remove the FDD-HDD tray.

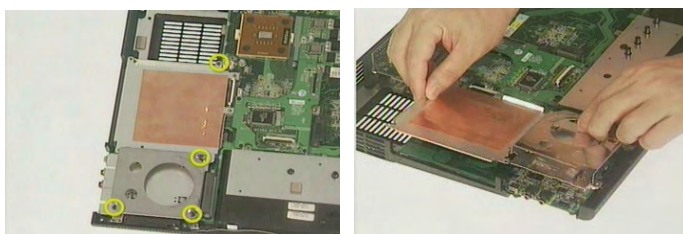

34. Disconnect the speaker cable from the main board.

35. Remove the two screws that secure the right and left speakers.

36. Then take out the speakers.

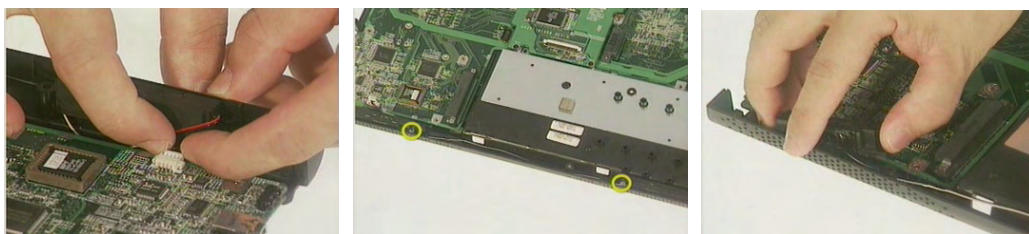

37. Remove the four hexagon screws on the rear as picture shows.

38. Then take out the main board.

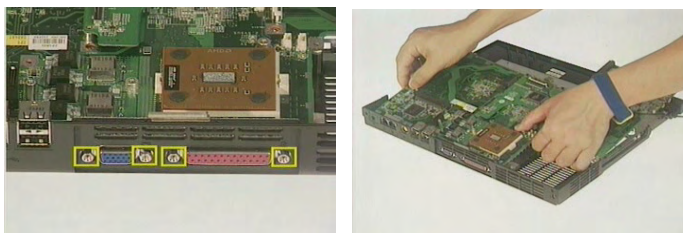

- 
39. Remove the four screws holding the Northbridge heat sink on the main board back.
  40. Then take off the Northbridge heat sink.

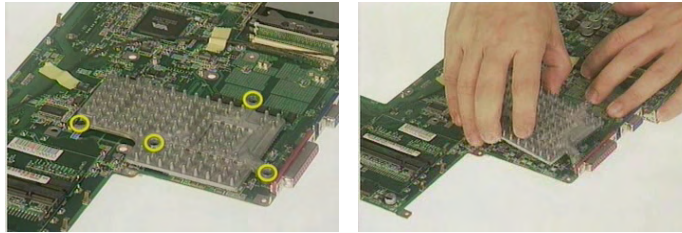

41. Remove the four screws that secure the PCMCIA slot.
42. Then detach the PCMCIA slot from the main board.

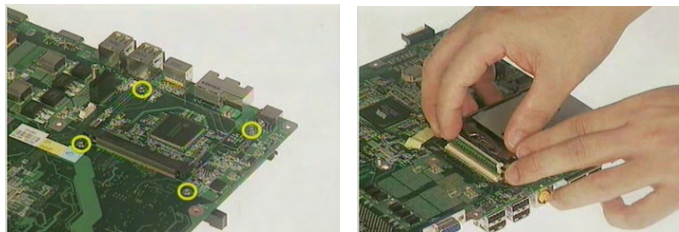

43. Remove the three screws that secure the VGA/TV-out board.
44. Then remove the VGA/TV-out board.

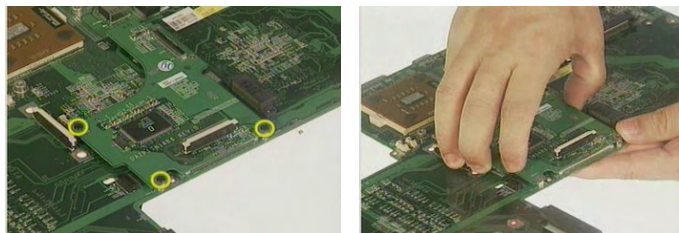

45. Unlock the CPU with a flat screwdriver.
46. Then remove the CPU from the CPU socket.

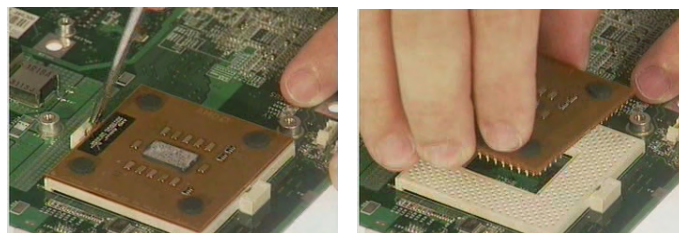

# Disassembling the LCD Module

1. Remove the two LCD cover rubbers and two LCD cushion rubbers.
2. Then remove the four screws holding the LCD bezel.
3. Detach the LCD bezel carefully.

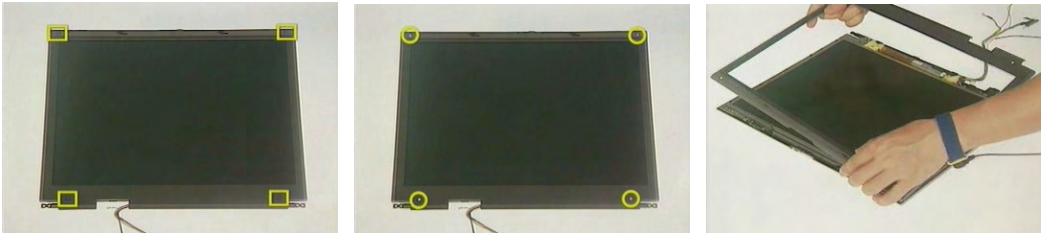

4. Tear off the tape that fastens the LCD inverter cable and the high voltage cable.
5. Disconnect the inverter cable.
6. Then disconnect the high voltage cable.

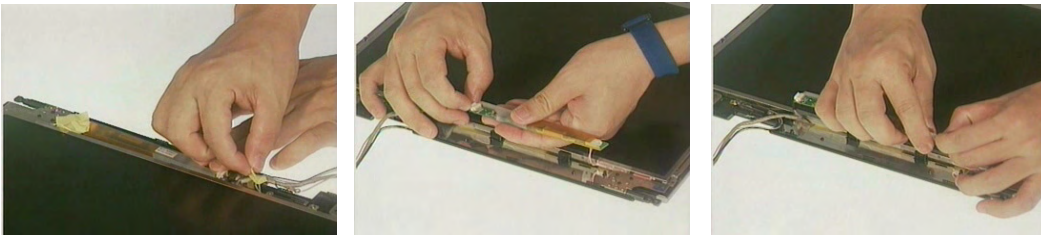

7. Remove one screw that secures the Bluetooth antenna.
8. Then remove the Bluetooth antenna.

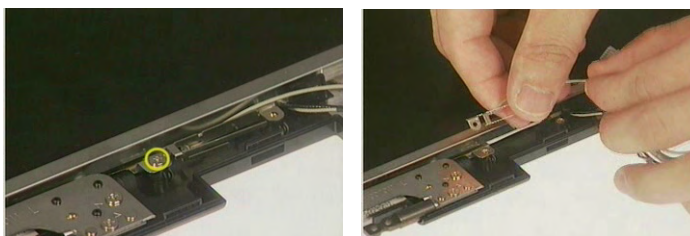

9. Remove the three screws on one side.



10. Remove another three screws on another side.

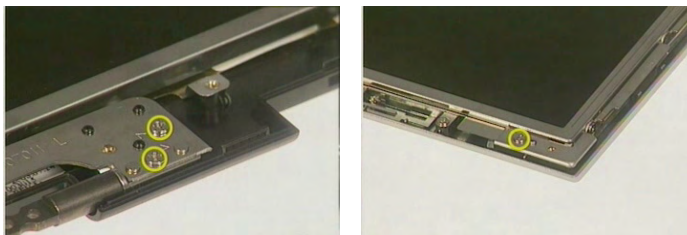

11. Remove the entire LCD from the LCD panel.



12. Remove the four screws that secure the LCD hook bracket.

13. Remove the LCD hook bracket.

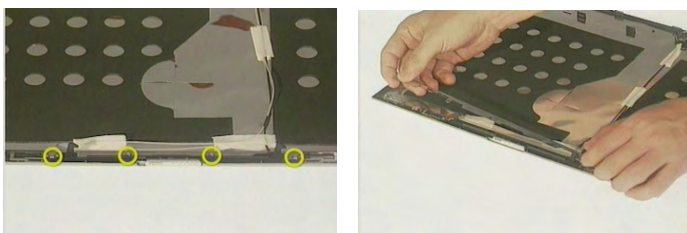

14. Remove one screw that secures the left aux wireless LAN antenna.

15. Remove one screw that secures the right main wireless LAN antenna.

16. Remove the wireless LAN antennas.

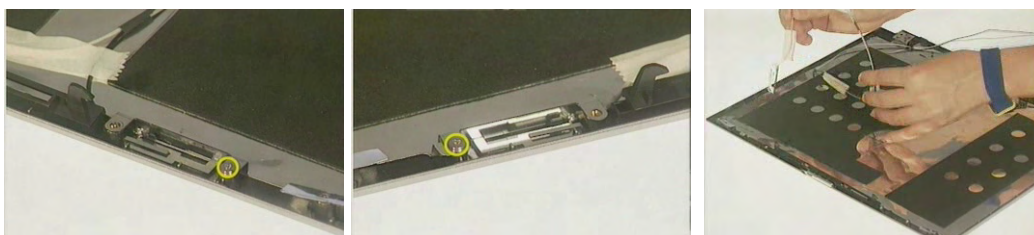



---

17. Remove the two screws holding the right LCD bracket.

18. Remove the right LCD bracket.

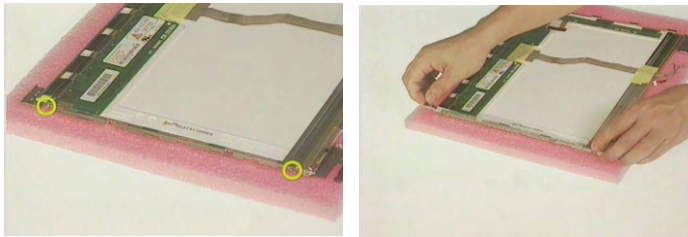

19. Remove another two screws holding the left LCD bracket.

20. Remove the left LCD bracket.

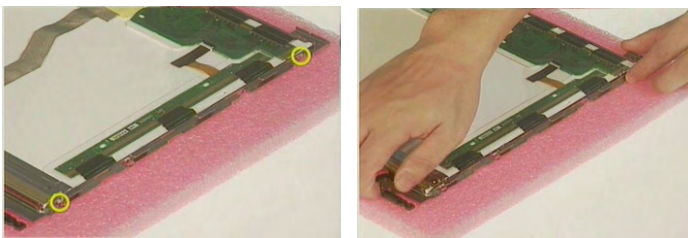

21. Tear off the tape that fastens the LCD coaxial cable as picture shows.

22. Disconnect the LCD coaxial cable.





---

# Disassembling the External Modules

## Disassembling the HDD Module

1. Remove the two screws holding the HDD bracket.
2. Remove another two screws that fasten the HDD bracket.

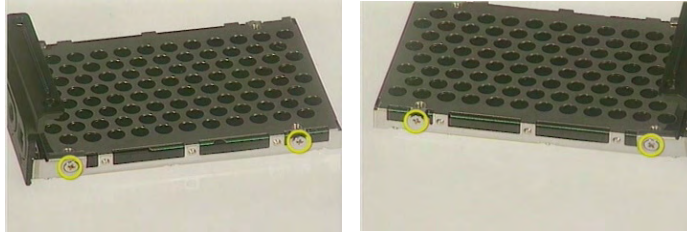

3. Remove the HDD bezel(cover).
4. Then remove the HDD bracket as picture shows.

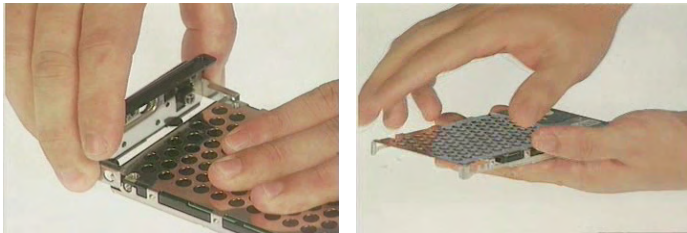

## Disassembling the Floppy Disk Drive Module

1. Remove the two screws holding the right FDD bracket.
2. Remove one screw holding the left FDD bracket.
3. Remove one screw holding the rear FDD bracket as picture shows.



4. Remove the FDD bracket. Then disconnect the FDD cable.

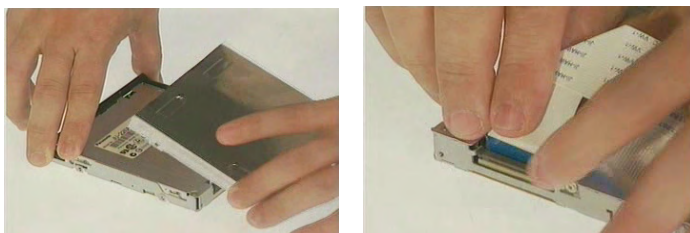

---

## Disassembling the Optical Drive Module

1. Remove the two screws that secure the ODD bracket.
2. Then remove the ODD bracket.

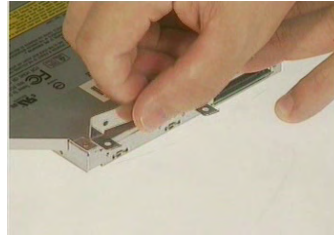
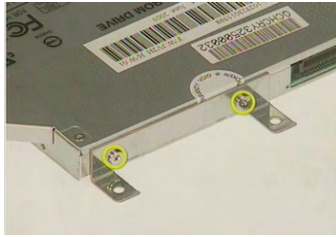

# Troubleshooting

Use the following procedure as a guide for computer problems.

**NOTE:** The diagnostic tests are intended to test this model. Non-Acer products, prototype cards, or modified options can give false errors and invalid system responses.

1. Duplicate symptom and obtain the failing symptoms in as much detail as possible.
2. Distinguish symptom. Verify the symptoms by attempting to re-create the failure by running the diagnostic test or by repeating the same operation.
3. Disassemble and assemble the unit without any power sources.
4. If any problem occurs, you can perform visual inspection before you follow this chapter's instructions. You can check the following:
  - power cords are properly connected and secured;
  - there are no obvious shorts or opens;
  - there are no obviously burned or heated components;
  - all components appear normal.
5. Use the following table with the verified symptom to determine which page to go to.

Symptoms (Verified)	Go To
Power failure. (The power indicator does not go on or stay on.)	"Power System Check" on page 63
POST does not complete. No beep or error codes are indicated.	"Power-On Self-Test (POST) Error Message" on page 63 "Undetermined Problems" on page 71
POST detects an error and displayed messages on screen.	"Error Message List" on page 65
The diagnostic test detected an error and displayed a FRU code.	"System Diagnostic Diskette" on page 39
Other symptoms (i.e. LCD display problems or others).	"Power-On Self-Test (POST) Error Message" on page 63
Symptoms cannot be re-created (intermittent problems).	Use the customer-reported symptoms and go to "Power-On Self-Test (POST) Error Message" on page 63 "Intermittent Problems" on page 70 "Undetermined Problems" on page 71

---

# System Check Procedures

## External Diskette Drive Check

Do the following to isolate the problem to a controller, driver, or diskette. A write-enabled, diagnostic diskette is required.

**NOTE:** Make sure that the diskette does not have more than one label attached to it. Multiple labels can cause damage to the drive or cause the drive to fail.

Do the following to select the test device. See “System Diagnostic Diskette” on page 39 for details.

1. Boot from the diagnostics diskette and start the diagnostics program (see “System Diagnostic Diskette” on page 39).
2. See if FDD Test is passed as the program runs to FDD Test.
3. Follow the instructions in the message window.

If an error occurs with the internal diskette drive, reconnect the diskette connector on the system board.

If the error still remains:

1. Reconnect the external diskette drive/DVD-ROM module.
2. Replace the external diskette drive/CD-ROM module.
3. Replace the main board.

## External CD-ROM Drive Check

Do the following to isolate the problem to a controller, drive, or CD-ROM. Make sure that the CD-ROM does not have any label attached to it. The label can cause damage to the drive or can cause the drive to fail.

Do the following to select the test device:

1. Boot from the diagnostics diskette and start the diagnostics program (refer to “System Diagnostic Diskette” on page 39).
2. See if CD-ROM Test is passed when the program runs to CD-ROM Test.
3. Follow the instructions in the message window.

If an error occurs, reconnect the connector on the System board. If the error still remains:

1. Reconnect the external diskette drive/CD-ROM module.
2. Replace the external diskette drive/CD-ROM module.
3. Replace the main board.

---

## Keyboard or Auxiliary Input Device Check

Remove the external keyboard if the internal keyboard is to be tested.

If the internal keyboard does not work or an unexpected character appears, make sure that the flexible cable extending from the keyboard is correctly seated in the connector on the system board.

If the keyboard cable connection is correct, run the Keyboard Test. See “System Diagnostic Diskette” on page 30 for details.

If the tests detect a keyboard problem, do the following one at a time to correct the problem. Do not replace a non-defective FRU:

1. Reconnect the keyboard cables.
2. Replace the keyboard.
3. Replace the main board.

The following auxiliary input devices are supported by this computer:

- Numeric keypad
- External keyboard

If any of these devices do not work, reconnect the cable connector and repeat the failing operation.

## Memory Check

Memory errors might stop system operations, show error messages on the screen, or hang the system.

1. Boot from the diagnostics diskette and start the doagmpstotics program (please refer to main board).
2. Go to the diagnostic memory in the test items.
3. Press F2 in the test items.
4. Follow the instructions in the message window.

**NOTE:** Make sure that the DIMM is fully installed into the connector. A loose connection can cause an error.

## Power System Check

To verify the symptom of the problem, power on the computer using each of the following power sources:

1. Remove the battery pack.
2. Connect the power adapter and check that power is supplied.
3. Disconnect the power adapter and install the charged battery pack; then check that power is supplied by the battery pack.

If you suspect a power problem, see the appropriate power supply check in the following list:

- “Check the Battery Pack” on page 62

---

## Check the Battery Pack

To check the battery pack, do the following:

From Software:

1. Check out the Power Management in control Panel
2. In Power Meter, confirm that if the parameters shown in the screen for Current Power Source and Total Battery Power Remaining are correct.
3. Repeat the steps 1 and 2, for both battery and adapter.
4. This helps you identify first the problem is on recharging or discharging.

From Hardware:

1. Power off the computer.
2. Remove the battery pack and measure the voltage between battery terminals 1(+) and 6(ground). See the following figure
3. If the voltage is still less than 7.5 Vdc after recharging, replace the battery.

To check the battery charge operation, use a discharged battery pack or a battery pack that has less than 50% of the total power remaining when installed in the computer.

If the battery status indicator does not light up, remove the battery pack and let it return to room temperature. Re-install the battery pack.

If the charge indicator still does not light up, replace the battery pack. If the charge indicator still does not light up, replace the DC/DC charger board.

## Touchpad Check

If the touchpad doesn't work, do the following actions one at a time to correct the problem. Do not replace a non-defective FRU:

1. After rebooting, run Tracking Pad PS2 Mode Driver. For example, run Syn touch driver.
2. Run utility with the PS/2 mouse function and check if the mouse is working.
3. If the the PS/2 mouse does not work, then check if the main board to switch board FPC is connected O.K.
4. If the main board to switch board FPC is connected well, then check if the FCC on touch pad PCB connects properly.
5. If the FFC on touch pad PCB connects properly, then check if LS851 JP1 Pin6=5V are pulese. If yes, then replace switch board. If no, then go to next step.
6. Replace touch pad PCB.
7. If the touch pad still does not work, then replace FPC on Track Pad PCB.

After you use the touchpad, the pointer drifts on the screen for a short time. This self-acting pointer movement can occur when a slight, steady pressure is applied to the touchpad pointer. This symptom is not a hardware problem. No service actions are necessary if the pointer movement stops in a short period of time.

---

## Power-On Self-Test (POST) Error Message

The POST error message index lists the error message and their possible causes. The most likely cause is listed first.

**NOTE:** Perform the FRU replacement or actions in the sequence shown in FRU/Action column, if the FRU replacement does not solve the problem, put the original part back in the computer. Do not replace a non-defective FRU.

This index can also help you determine the next possible FRU to be replaced when servicing a computer.

If the symptom is not listed, see “Undetermined Problems” on page 71.

The following lists the error messages that the BIOS displays on the screen and the error symptoms classified by function.

**NOTE:** Most of the error messages occur during POST. Some of them display information about a hardware device, e.g., the amount of memory installed. Others may indicate a problem with a device, such as the way it has been configured.

**NOTE:** If the system fails after you make changes in the BIOS Setup Utility menus, reset the computer, enter Setup and install Setup defaults or correct the error.

---

# Index of Error Messages

## Error Message List

Error Messages	FRU/Action in Sequence
Struck Key	See "Keyboard or Auxiliary Input Device Check" on page 61
System CMOS checksum bad - Default configuration used	RTC battery Run BIOS Setup Utility to reconfigure system, then reboot system.
Real time clock error	RTC battery Run BIOS Setup Utility to reconfigure system time, then reboot system. Main board
Previous boot incomplete - Default configuration used	"Load Default Settings" in BIOS Setup Utility. RTC batter Main board.
Invalid System Configuration Data	"Load Default Settings" in BIOS Setup Utility. Main board.
Operating system not found	Enter Setup and see if fixed disk and drive A are properly identified. Dikette drive Hard disk drive Main board.



Error Message List

No beep Error Messages	FRU/Action in Sequence
Power-on indicator turns off and LCD is blank.	Power source (battery pack and power adapter.) See "Power System Check" on page 61 Ensure every connector is connected tightly and correctly. Reconnect the DIMM. Main board.
Power-on indicator turns on and LCD is blank.	Power source (battery pack and power adapter.) See "Power System Check" on page 61 Reconnect the LCD connector Hard disk drive LCD cable LCD inverter LCD Main board
Power-on indicator turns on and LCD is blank. But you can see POST on an external CRT.	Reconnect the LCD connectors. LCD cable LCD inverter LCD Main board
Power-on indicator turns on and a blinking cursor shown on LCD during POST.	Ensure every connector is connected tightly and correctly. Main board

# Index of Symptom-to-FRU Error Message

## LCD-Related Symptoms

Symptom / Error	Action in Sequence
LCD backlight doesn't work	First, plug a monitor to CRT port. Next, enter BIOS utility to running "Load Default Settings" then reboot the system. Reconnect the LCD connectors. Keyboard (if the brightness function key doesn't work). LCD cable LCD inverter LCD Main board
LCD is too dark LCD brightness cannot be adjusted	Enter BIOS Utility to execute "Load Setup Default Settings", then reboot system. Reconnect the LCD connectors. Keyboard (if the brightness function key doesn't work). LCD cable LCD inverter LCD Main board
Unreadable LCD screen Missing pels in characters Abnormal screen Wrong color displayed LCD has extra horizontal or vertical lines displayed.	Reconnect the LCD cable LCD cable LCD Main board

## Indicator-Related Symptoms

Symptom / Error	Action in Sequence
Indicator incorrectly remains off or on, but system runs correctly	Main board
HDD/CD-ROM active indicators cannot work	HDD/CD-ROM drive Device driver Main board

## Power-Related Symptoms

Symptom / Error	Action in Sequence
Power shuts down during operation	Power source (battery pack and power adapter). See "Power System Check" on page 61. Battery pack AC adapter See if the thermal module is overheat (Heat sink or fan). Main board
The system cannot power-on.	Power source (battery pack and power adapter). See "Power System Check" on page 61. Battery pack Power adapter CPU Main board
The system cannot power-off.	In Windows XP operating system, hold and press the power switch for more than 4 seconds. If the system can power off, then the main board is OK. Verify OS in the HDD. Main board

### Power-Related Symptoms

Symptom / Error	Action in Sequence
Battery can't be charged or discharged	See "Check the Battery Pack" on page 62. Battery pack Main board
System hang during POST	ODD/HDD/FDD/RAM module Main board

### PCMCIA-Related Symptoms

Symptom / Error	Action in Sequence
System cannot detect the PC Card (PCMCIA)	PCMCIA slot assembly Main board
PCMCIA slot pin is damaged.	PCMCIA slot assembly
PC Card cannot be inserted or ejected	Check if the PCMCIA slot is blocked Main board

### Memory-Related Symptoms

Symptom / Error	Action in Sequence
Memory count (size) appears different from actual size.	Enter BIOS Setup Utility to execute "Load Default Settings" then reboot system. RAM module Main board Check BIOS revision
System can power on, but you hear two long beeps: "B--, B--" and the LCD is blank.	Reinsert DIMM DIMM Main board

### Speaker-Related Symptoms

Symptom / Error	Action in Sequence
In Windows, multimedia programs, no sound comes from the computer.	OS volume control Audio driver Speaker Main board
Internal speakers make noise or emit no sound.	Speaker Main board
Microphone cannot work	Audio driver Volume control in Windows XP Main board

### Power Management-Related Symptoms

Symptom / Error	Action in Sequence
The system will not enter hibernation mode	Power option in Windows XP Hard disk drive Main board
The system doesn't enter standby mode after closing the lid of the portable computer.	Driver of Power Option Properties Lid close switch in upper case Main board

### Power Management-Related Symptoms

Symptom / Error	Action in Sequence
The system doesn't resume from hibernation/standby mode.	Connect AC adapter then check if the system resumes from Standby/Hibernation mode. Check if the battery is low. Hard disk drive Main board
The system doesn't resume from standby mode after opening the lid of the portable computer.	LCD cover switch Main board
Battery fuel gauge in Windows doesn't go higher than 90%.	Refresh battery (continue use battery until power off, then charge battery). Battery pack Main board
System hangs intermittently.	Reconnect hard disk/CD-ROM drives. Main board

### Peripheral-Related Symptoms

Symptom / Error	Action in Sequence
System configuration does not match the installed devices.	Enter BIOS Setup Utility to execute "Load Setup defaults", then reboot system. Reconnect hard disk/CD-ROM drives/FDD or other peripherals. Main board
External display does not work correctly.	Press Fn+F5, LCD/CRT/Both display switching Keyboard Main board
USB does not work correctly	See "System Diagnostic Diskette" on page 39 Main board
Print problems.	Enter BIOS Setup Utility to execute "Load Default Settings" then reboot the system. Run printer self-test. Printer driver Printer cable Printer Main board
Parallel port device problems	Enter BIOS Setup Utility to execute "Load Default Settings" then reboot the system. Device driver Device cable Device Main board

### Keyboard/Touchpad-Related Symptoms

Symptom / Error	Action in Sequence
Keyboard (one or more keys) does not work.	Reconnect the keyboard cable. Keyboard Main board
Touchpad does not work.	Reconnect touchpad cable. Touchpad board Main board

---

Modem/LAN-Related Symptoms

Symptom / Error	Action in Sequence
Internal modem does not work correctly.	See "System Diagnostic Diskette" on page 39. Phone cable Driver Reconnect the Internal modem cable to the main board tightly. Main board
Internal LAN does not work correctly	Lan cable Driver Main board

**NOTE:** If you cannot find a symptom or an error in this list and the problem remains, see "Undetermined Problems" on page 57.

---

## Intermittent Problems

Intermittent system hang problems can be caused by a variety of reasons that have nothing to do with a hardware defect, such as: cosmic radiation, electrostatic discharge, or software errors. FRU replacement should be considered only when a recurring problem exists.

When analyzing an intermittent problem, do the following:

1. Run the diagnostic test for the system board in loop mode at least 10 times.
2. If no error is detected, do not replace any FRU.
3. If any error is detected, replace the FRU. Rerun the test to verify that there are no more errors.

---

# Undetermined Problems

The diagnostic problems does not identify which adapter or device failed, which installed devices are incorrect, whether a short circuit is suspected, or whether the system is inoperative.

Follow these procedures to isolate the failing FRU (do not isolate non-defective FRU).

**NOTE:** Verify that all attached devices are supported by the computer.

**NOTE:** Verify that the power supply being used at the time of the failure is operating correctly. (See “Power System Check” on page 61):

1. Power-off the computer.
2. Visually check them for damage. If any problems are found, replace the FRU.
3. Remove or disconnect all of the following devices:
  - Non-Acer devices
  - Printer, mouse, and other external devices
  - Battery pack
  - Hard disk drive
  - DIMM
  - PC Cards
4. Power-on the computer.
5. Determine if the problem has changed.
6. If the problem does not recur, reconnect the removed devices one at a time until you find the failing FRU.
7. If the problem remains, replace the following FRU one at a time. Do not replace a non-defective FRU:
  - System board
  - LCD assembly





# Jumper and Connector Locations

## Top View

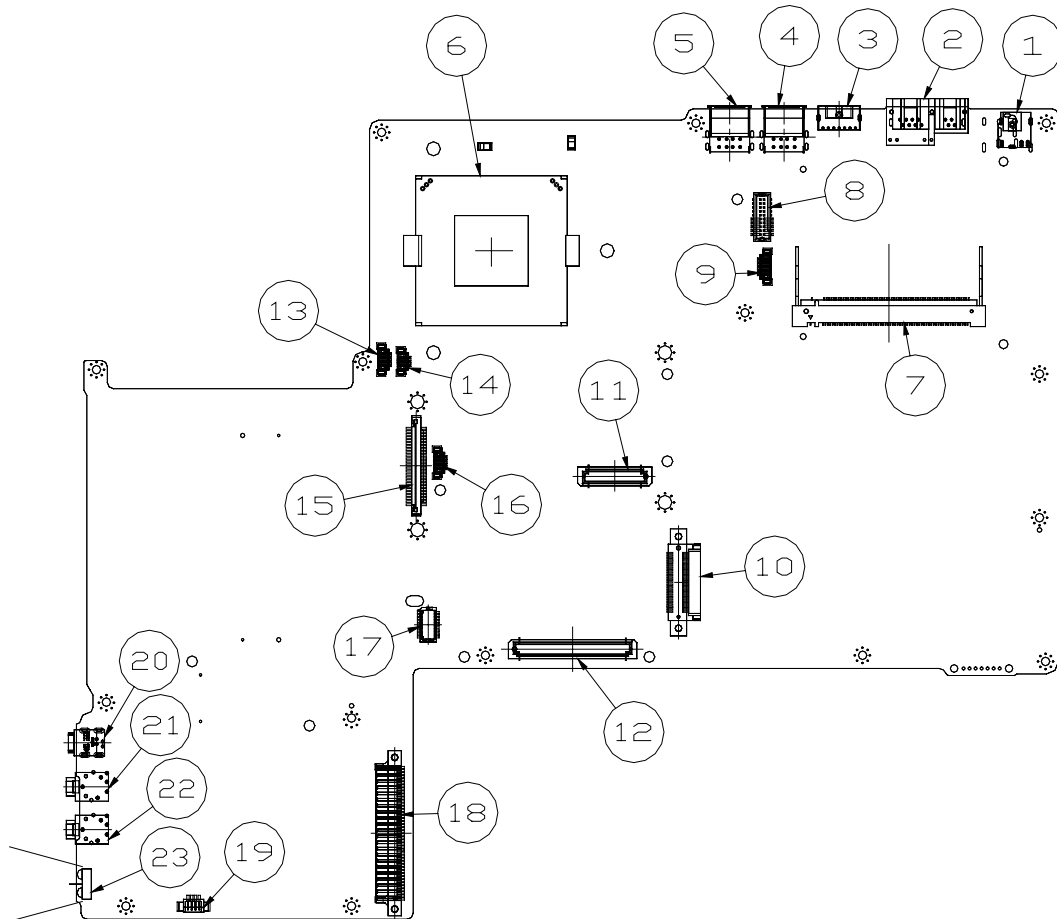

1	DC-In	13	Heat Sink 4-pin Controller
2	RJ11 / RJ45	14	Heat Sink 3-pin Controller
3	S-Video	15	FDD Connector
4	USB Connectors (*2)	16	4-In-1 Connector
5	USB Connectors (*2)	17	Touchpad Board Connector
6	CPU Socket	18	HDD Connector
7	Mini-PCI Socket	19	Speaker Connector
8	Launch Board Connector	20	IEEE 1394 Connector
9	LCD Inverter Connector	21	Microphone-in Connector
10	ODD Connector	22	Headphone Connector
11	VGA Board 60-pin Connector	23	Infrared Connector
12	VGA Board 120-pin Connector		

# Bottom View

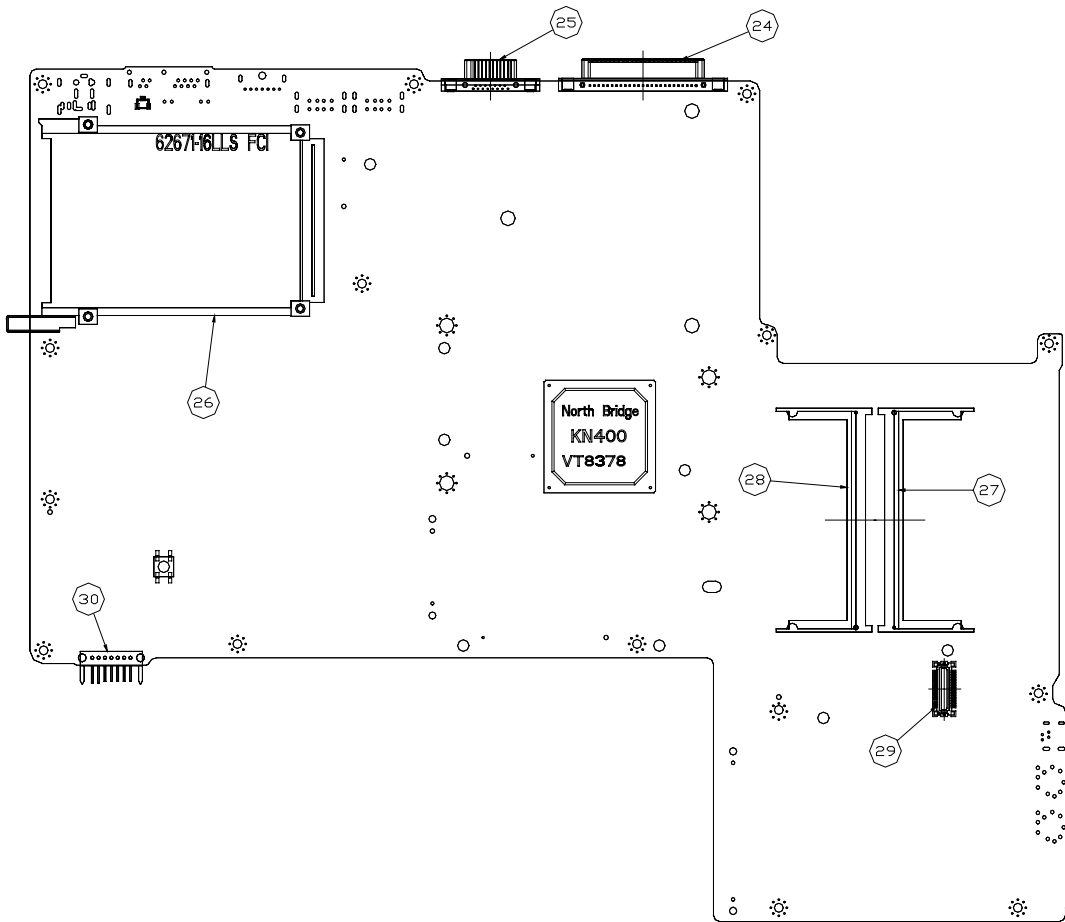

- |    |                            |    |                     |
|----|----------------------------|----|---------------------|
| 24 | Parallel Connector         | 28 | DDR Controller      |
| 25 | External Display Connector | 29 | MDC Board Connector |
| 26 | PCMCIA Connector           | 30 | Battery Connector   |
| 27 | DDR Connector              |    |                     |
| 24 | Parallel Connector         | 28 | DDR Controller      |

## FRU (Field Replaceable Unit) List

---

This chapter gives you the FRU (Field Replaceable Unit) listing in global configurations of Aspire 1350. Refer to this chapter whenever ordering for parts to repair or for RMA (Return Merchandise Authorization). Please also note that there are some common parts for Aspire 1350, yet the LCD modules are different in two model.

Please note that WHEN ORDERING FRU PARTS, you should check the most up-to-date information available on your regional web or channel. For whatever reasons a part number change is made, it will not be noted on the printed Service Guide. For ACER AUTHORIZED SERVICE PROVIDERS, your Acer office may have a DIFFERENT part number code from those given in the FRU list of this printed Service Guide. You MUST use the local FRU list provided by your regional Acer office to order FRU parts for repair and service of customer machines.

**NOTE:** To scrap or to return the defective parts, you should follow the local government ordinance or regulations on how to dispose it properly, or follow the rules set by your regional Acer office on how to return it.

# Exploded Diagram

## THE Base

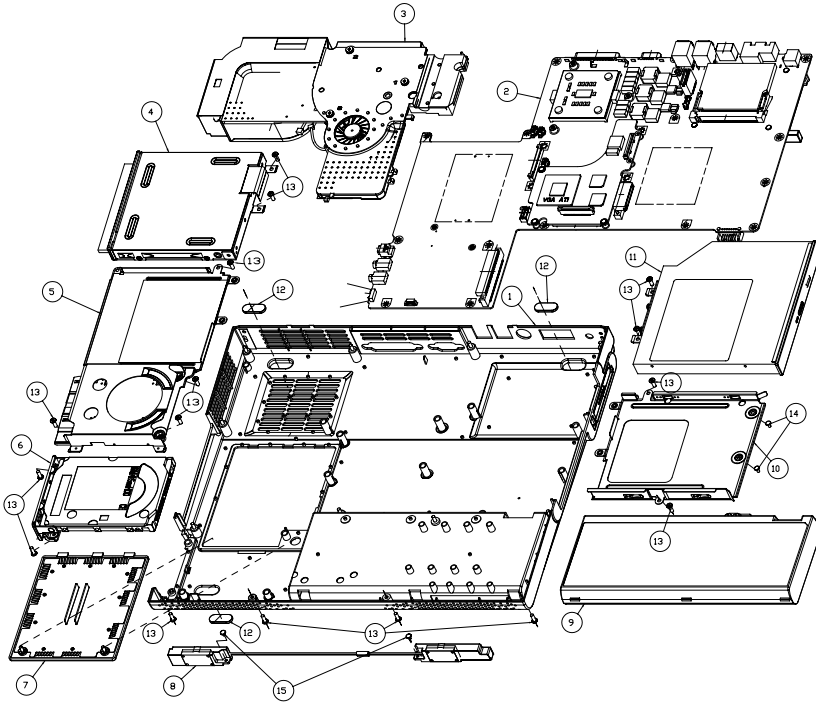

ITEM	DESCRIPTION	REMARK
15	ET2S SCREW MM2.0*3.0 SPARE PART	
14	ZPI SCREW M2.5*6L-NI-NYLK S/P	
13	ZPI SCREW M2.5*7L-BNI-NYLK S/P	
12	ZPI RUBBER FOOT S/P	
11	ZPI BX DVD-RW MODULE S/P (TEAC/PIIONEER)	
11	ZPI 24X COMBO MODULE S/P (QSILITE-IN/TEAC)	
11	ZPI BX DVD-RW MODULE S/P (QSILITE-IN)	
11	ZPI 24X CRDM MODULE S/P (QSILITE)	
10	ZPI COMBO TRAY S/P	
9	ZPI BATTERY S/P-PANASONIC LI-ION S/P	
9	ZPI BATTERY S/P-SANYO LI-ION S/P	
8	ZPI SPEAKER S/P	
7	ZPI RAM DODR ASSY S/P	
6	ZPI HDD MODULE	
5	ZPI FDD TRAY S/P	
4	ZPI WEIGHT SAVER S/P	
4	ZPI CARD READER MODULE S/P	
4	ZPI FDD MODULE S/P-MITSUMI	
4	ZPI FDD MODULE S/P-PANASONIC	
3	ZPI HEATSINK ASSY S/P	
2	ZPI M/B S/P	
1	ZPI BASE ASSY S/P	
ITEM	DESCRIPTION	REMARK

## LCD 14.1" / 15.0"

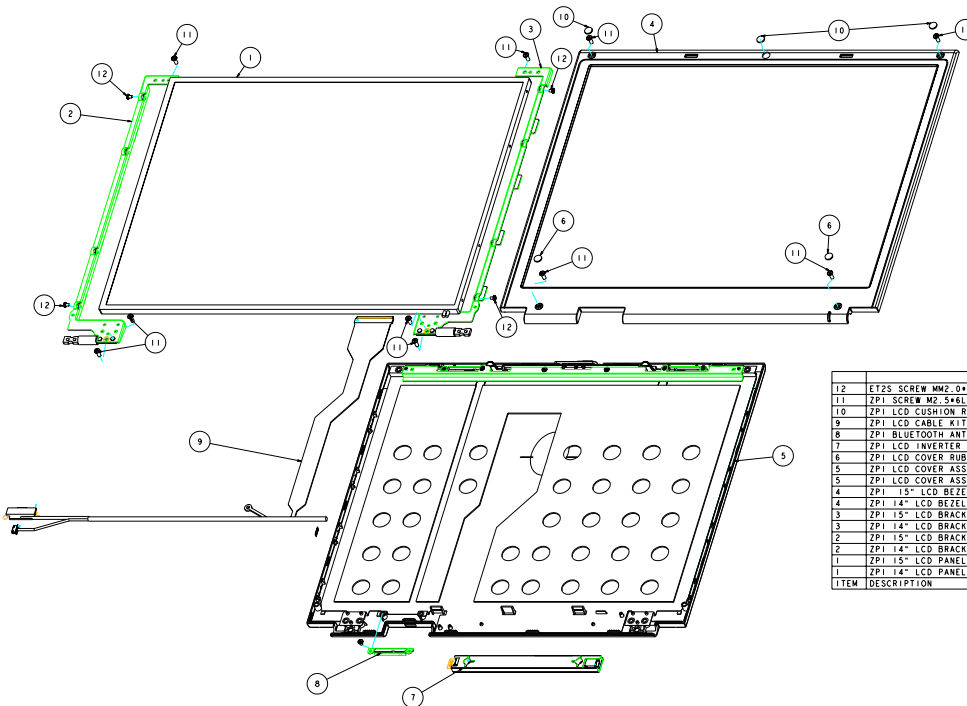

ITEM	DESCRIPTION	REMARK
12	ET2S SCREW MM2.0*3.0 SPARE PART	
11	ZPI SCREW M2.5*6L-NI-NYLK S/P	
10	ZPI LCD CUSHION RUBBER S/P	
9	ZPI LCD CABLE KIT S/P	
8	ZPI BLUETOOTH ANTENNA S/P	
7	ZPI LCD INVERTER ASSY S/P	
6	ZPI LCD COVER RUBBER S/P	
5	ZPI LCD COVER ASSY W/O WIRELESS S/P	
5	ZPI LCD COVER ASSY W/O WIRELESS S/P	
4	ZPI 15" LCD BEZEL S/P	
4	ZPI 14" LCD BEZEL S/P	
3	ZPI 15" LCD BRACKET-R S/P	
3	ZPI 14" LCD BRACKET-R S/P	
2	ZPI 15" LCD BRACKET-L S/P	
2	ZPI 14" LCD BRACKET-L S/P	
1	ZPI 15" LCD PANEL S/P-ODI	
1	ZPI 14" LCD PANEL S/P-AU	
ITEM	DESCRIPTION	REMARK

## Main Board

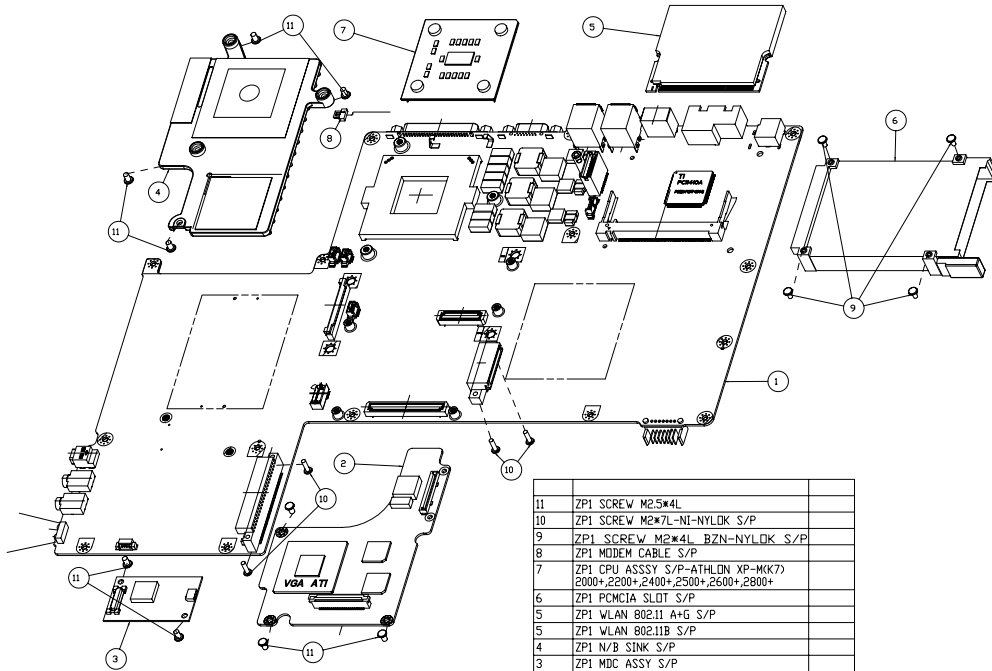

ITEM	DESCRIPTION	REMARK
11	ZP1 SCREW M2.5*4L	
10	ZP1 SCREW M2*7L-NI-NYLOK S/P	
9	ZP1 SCREW M2*4L BZN-NYLOK S/P	
8	ZP1 MODEM CABLE S/P	
7	ZP1 CPU ASSY S/P-ATHLON XP-MK(7) 2000+,2200+,2400+,2500+,2600+,2800+	
6	ZP1 PCMCIA SLOT S/P	
5	ZP1 WLAN 802.11 A+G S/P	
5	ZP1 WLAN 802.11B S/P	
4	ZP1 N/B SINK S/P	
3	ZP1 MDC ASSY S/P	
2	ZP1 VGA BOARD-128M S/P	
2	ZP1 VGA BOARD-64M S/P	
2	ZP1 TV-OUT BOARD S/P	
1	ZP1 MB S/P	
	ITEM DESCRIPTION	REMARK

## Module

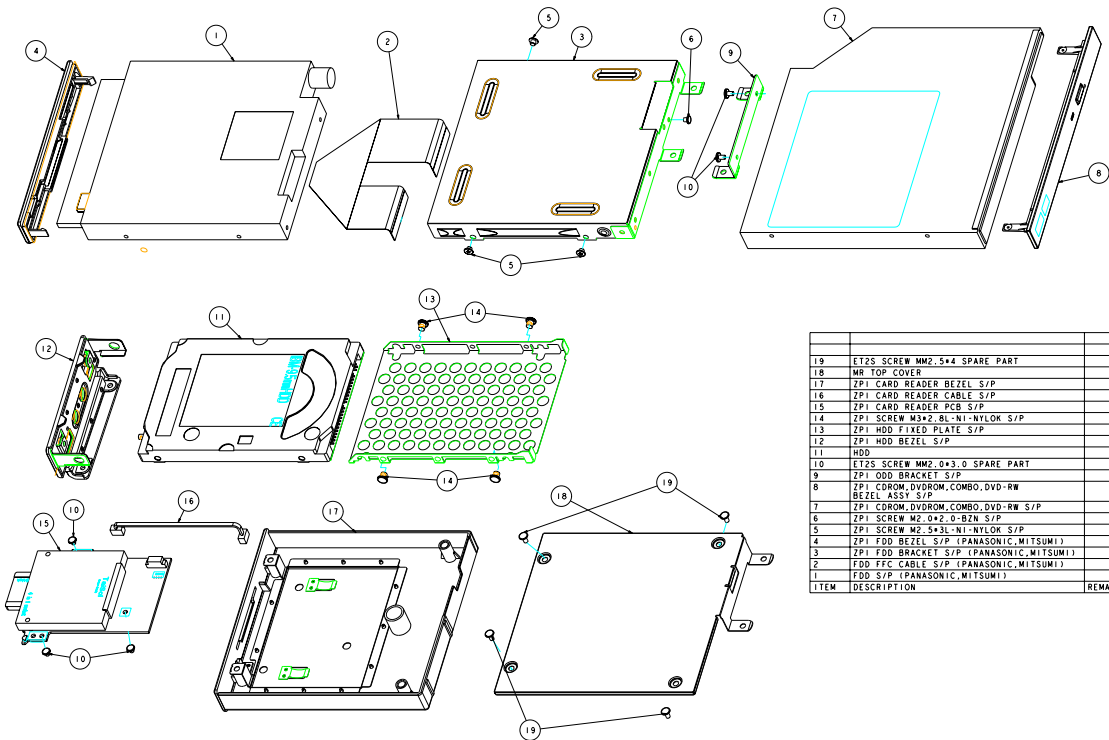

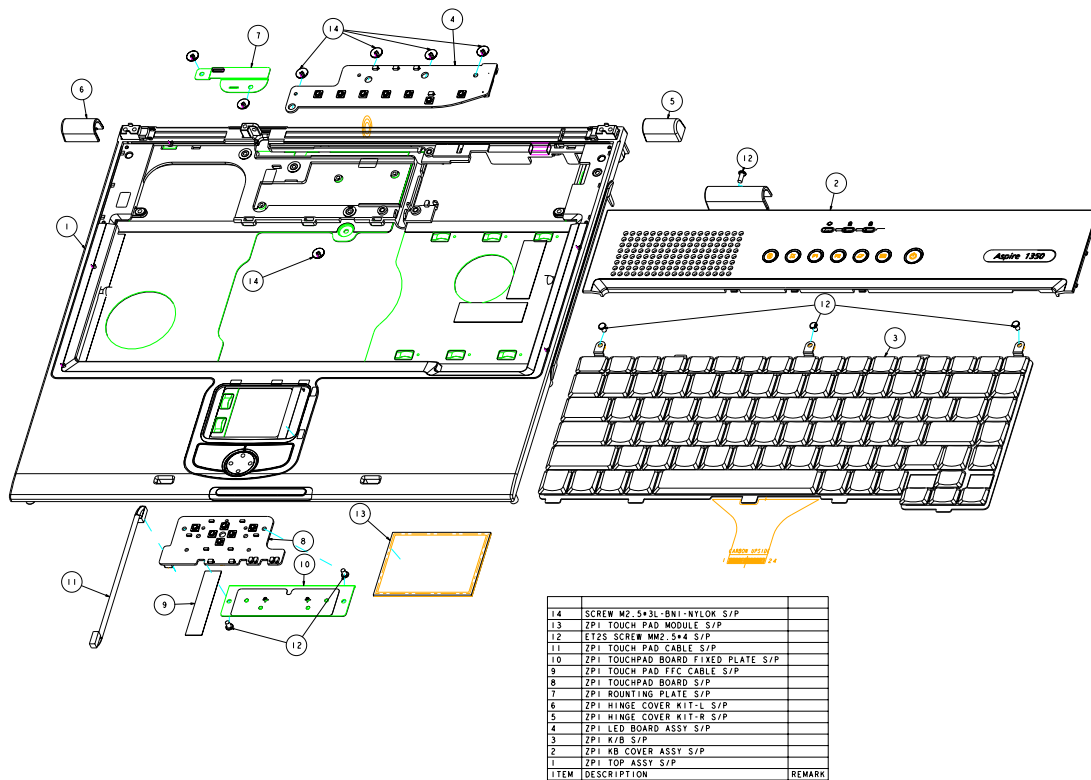

ITEM	DESCRIPTION	REMARK
19	ET25 SCREW MM2.5*4 SPARE PART	
18	MR TOP COVER	
17	ZP1 CARD READER BEZEL S/P	
16	ZP1 CARD READER CABLE S/P	
15	ZP1 CARD READER PCB S/P	
14	ZP1 SCREW M3*2.8L-NI-NYLOK S/P	
13	ZP1 HDD FIXED PLATE S/P	
12	ZP1 HDD BEZEL S/P	
11	HDD	
10	ET25 SCREW MM2.0*3.0 SPARE PART	
9	ZP1 ODD BRACKET S/P	
8	ZP1 CDROM, DVDROM, COMBO, DVD-RW BEZEL ASSY S/P	
7	ZP1 CDROM, DVDROM, COMBO, DVD-RW S/P	
6	ZP1 SCREW M2.0*2.0-BZN S/P	
5	ZP1 SCREW M2.5*3L-NI-NYLOK S/P	
4	ZP1 FDD BEZEL S/P (PANASONIC, MITSUMI)	
3	ZP1 FDD BRACKET S/P (PANASONIC, MITSUMI)	
2	FDD FFC CABLE S/P (PANASONIC, MITSUMI)	
1	FDD S/P (PANASONIC, MITSUMI)	
	ITEM DESCRIPTION	REMARK

Top









**NOTE:** Some part numbers appear on the exploded diagram are vendor's part number. Please refer to the FRU list for Acer part number.

Picture	Partname And Description	Part Number
CPU/Processor		
	AMD Athlon XP-M, Thoroughbred 2000+ 72W/ 256K L2/ FSB 200/266M AMD Athlon XP-M, Thoroughbred 2200+ 72W/ 256K L2/ FSB 200/266M AMD Athlon XP-M, Barton 2400+ 72W/ 512K L2/ FSB 266M AMD Athlon XP-M, Barton 2500+ 72W/ 512K L2/ FSB 266M AMD Athlon XP-M, Barton 2600+ 72W/ 512K L2/ FSB 266M AMD Athlon XP-M, Barton 2800+ 72W/ 512K L2/ FSB 266M	KC.A2002.72T KC.A2202.72T KC.A2402.72B KC.A2502.72B KC.A2602.72B KC.A2802.72B
Memory		
	INFINEON 128MB DDR333 HYS64D16000GDL-6-B NANYA 128MB DDR333 NT128D64SH4BBGM-6K INFINEON 256MB DDR333 HYS64D32020GDL-6-B NANYA 256MB DDR333 NT256D64SH8BAGM-6K ELPIDA 256MB DDR333 EBD26UC6AKSA-6B INFINEON 512MB DDR333 HYS64D64020GBDL-6-B NANYA 512MB DDR333 NT512D64S8HBAFM-6K	KN.12802.006 KN.12803.008 KN.25602.009 KN.25603.009 KN.25609.002 KN.51202.007 KN.51203.005
LCD		
	ASSY LCD MODULE 14.1" QDI QDI141LH12 ASSY LCD MODULE 14.1" QDI QDI141LH12 FOR WIRELESS ASSY LCD MODULE 14.1" AU B141XG05 ASSY LCD MODULE 14.1" AU B141XG05 FOR WIRELESS ASSY LCD MODULE 15.0" QDI QDI150XL06-01 ASSY LCD MODULE 15.0" QDI QDI150XL06-01 FOR WIRELESS ASSY LCD MODULE 15.0" AU B150XG01 V2 ASSY LCD MODULE 15.0" AU B150XG01 V2 FOR WIRELESS ASSY LCD MODULE 15.0" CPT CLAA150XH01-S ASSY LCD MODULE 15.0" CPT CLAA150XH01-S FOR WIRELESS	6M.A10V7.011 6M.A10V7.021 6M.A10V7.012 6M.A10V7.022 6M.A10V7.013 6M.A10V7.023 6M.A10V7.014 6M.A10V7.024 6M.A10V7.015 6M.A10V7.025
	LCD 14.1" XGA QDI QD141X1LH03 LCD 14.1" XGA AU B141XG05 LCD 15.0" XGA QDI QDI150XL06-01 LCD 15.0" XGA AU B150XG01 V2 LCD 15.0" XGA CPT CLAA150XH01-S	LK.14109.003 LK.14105.006 LK.15009.002 LK.15005.001 LK.1500A.002
	LCD INVERTER BOARD	19.A10V7.001
	LCD BRACKET R 14.1" LCD BRACKET R 15"	33.A10V7.008 33.A10V7.010
	LCD BRACKET L 14.1" LCD BRACKET L 15"	33.A10V7.009 33.A10V7.011

Picture	Partname And Description	Part Number
	LCD PANEL WITH LOGO W/O ANTENNA LCD PANEL WITH LOGO W/ ANTENNA	60.A10V7.005 60.A10V7.006
	LCD BEZEL - 14.1" LCD BEZEL - 15"	60.A10V7.003 60.A10V7.004
	LCD COAXIAL CABLE	50.A10V7.006
FDD/Floppy Disk Drive		
	FDD MODULE, PANASONIC JU-226A273FC	6M.A10V7.010
	FDD DRIVE PANASONIC JU-226A273FC	KF.22602.002
	FDD FPC CABLE FOR PANASONIC	50.A10V7.005
	FDD BEZEL FOR PANASONIC	42.A10V7.014
	FDD BRACKET FOR PANASONIC	33.A10V7.006



Picture	Partname And Description	Part Number
HDD/ Hard Disk Drive		
	HDD 2.5" 20G HGST MORAGA IC25N020ATMR04-0 4200 RPM HDD 2.5" 30G HGST MORAGA IC25N030ATMR04-0 4200 RPM HDD 2.5" 40G HGST MORAGA IC25N040ATMR04-0 4200 RPM HDD 2.5" 60G HGST MORAGA IC25N060ATMR04-0 4200 PRM HDD 2.5" 60G HGST MORAGA IC25N060ATMR05-0 5400 PRM HDD 2.5" 20G TOSHIBA MK2023GAS 4200 RPM HDD 2.5" 30G TOSHIBA MK3021GAS(CZE) 4200 RPM HDD 2.5" 40G TOSHIBA MK4021GAS(CZE) 4200 RPM HDD 2.5" 60G TOSHIBA MK6021GAS(CZE) 4200 RPM HDD 2.5" 60G TOSHIBA MK6022GAX 5400 RPM HDD 2.5" 30G FUJITSU 4200 RPM V-40 F/W:009A	KH.02007002 KH.03007002 KH.04007002 KH.06007002 KH.06007.003 KH.02004.001 KH.33004.001 KH.34004.001 KH.36004.001 KH.06004.001 KH.03006.002
	HDD BEZEL	42.A10V7.015
	HDD BRACKET	33.A10V7.007
Optical Drive/Combo Drive		
	CD-ROM MODULE 24X QSI SCR-242EA5E DVD-ROM MODULE 8X QSI SDR-083E05E DVD/CDRW COMBO MODULE 24X QSI SBW-242E05E DVD/CDRW COMBO MODULE 24X LITE-ON LSC-24082K DVD/CDRW COMBO MODULE 24X TEAC DW-224E-92 DVD-RW MODULE TEAC DV-W22E-195 DVD-RW MODULE PIONEER DVR-K11	6M.A10V7.001 6M.A10V7.003 6M.A10V7.005 6M.A10V7.006 6M.A10V7.007 6M.A10V7.008 6M.A10V7.009
	CD-ROM DRIVE 24X QSI SCR-242EA5E DVD-ROM DRIVE 8X QSI SDR-083E05E DVD/CDRW COMBO DRIVE 24X QSI SBW-242E05E DVD/CDRW COMBO DRIVE 24X LITE-ON LSC-24082K DVD/CDRW COMBO DRIVE 24X TEAC DW-224E-92 DVD-RW DRIVE TEAC DV-W22E-195 DVD-RW DRIVE PIONEER DVR-K11	KD.24X02.002 KV.08X02.003 KO.24X07.003 KO.24X09.001 KO.24X06.001 KW.02X0D.002 KW.02X05.001
	CD-ROM BEZEL FOR QSI DVD-ROM BEZEL FOR QSI DVD/CDRW BEZEL FOR QSI DVD/CDRW BEZEL FOR LITE-ON DVD/CDRW BEZEL FOR TEAC DVD-RW BEZEL FOR TEAC DVD-RW BEZEL FOR PIONEER	42.A10V7.005 42.A10V7.007 42.A10V7.009 42.A10V7.010 42.A10V7.011 42.A10V7.012 42.A10V7.013
	OPTICAL DEVICE BRACKET	33.A10V7.005

Picture	Partname And Description	Part Number
Cables		
	POWER CORD US (3 PIN) POWER CORD EU (3 PIN) POWER CORD PRC (3 PIN) POWER CORD UK (3 PIN) POWER CORD ITALIAN (3 PIN) POWER CORD DANISH (3 PIN) POWER CORD AU (3 PIN)	27.A03V7.001 27.A03V7.002 27.A03V7.003 27.A03V7.004 27.A03V7.005 27.A03V7.006 27.A03V7.008
	TOUCHPAD BOARD CABLE	50.A10V7.001
	MODEM CABLE	50.A10V7.002
	FFC- TOUCHPAD CABLE	50.A10V7.003
Antenna		
	BLUETOOTH ANTENNA	50.A10V7.004
Boards		
	MAINBOARD W/KN400 CHIPSET, PCMCIA SLOT, W/O CPU, MEMORY	MB.A1006.001
	MODEM CARD , AMBIT T60M283.15 MODEM/ BLUETOOTH COMBO CARD, AMBIT MRS-T60M665.00	54.A10V7.001 54.T23V7.002
	WIRELESS LAN CARD (802.11b),WNC KM8-1 WIRELESS LAN CARD (802.11a+g) ,WNC CM6	54.A10V7.002 54.A10V7.003
	LAUNCH BOARD	55.A10V7.001
	TOUCHPAD BOARD	55.A10V7.002

Picture	Partname And Description	Part Number
	TV-OUT BOARD VGA BOARD 64M VGA BOARD 128M	55.A10V7.003 55.A10V7.004 55.A10V7.005
	TOUCHPAD	56.A10V7.001
PCMCIA slot/PC card slot		
	PCMCIA SLOT	22.A10V1.001
Adapter		
	ADAPTER LITE- ON PA-1900-05QA 3PIN W/LED 90W ADAPTER LSE 0202C1990 3PIN W/LED 90W	AP.A1003.001 AP.A1007.001
Battery		
	BATTERY SANYO LI-ION 8CELL,SANYO, 4UR18650F-2-QC-24 BATTERY SIMPLO LI-ION 8CELL, PANASONIC,916-2540	BT.A1003.002 BT.A1007.001
Case/Cover/Bracket Assembly		
	MIDDLE COVER W/ NAME PLATE	42.A10V7.001
	DIMM DOOR	42.A10V7.002
	LOWER CASE W/ SPEAKER	60.A10V7.001

Picture	Partname And Description	Part Number
	UPPER CASE W/ TOUCHPAD, FPC	60.A10V7.002
	HINGE COVER R	42.A10V7.003
	HINGE COVER L	42.A10V7.004
	ROUNDING PLATE	33.A10V7.001
	OPTICAL TRAY	33.A10V7.002
	FDD-HDD TRAY	33.A10V7.003
	TOUCHPAD BOARD FIXED PLATE	33.A10V7.004
	WEIGHT SAVER	LC.A10V7.002
READER		
	4-IN-1 CARD READER MODULE	LC.A1003.001
	4 IN 1 CARD READER BOARD	55.A10V7.006
	4 IN 1 CARD READER CABLE	50.A10V7.007
	4 IN 1 CARD READER BEZEL	42.A10V7.016
Speaker		
	SPEAKER	23.A10V7.001
Keyboard		

Picture	Partname And Description	Part Number	
	KEYBOARD JME US INTERNATIONAL KEYBOARD JME UK KEYBOARD JME GERMAN KEYBOARD JME ITALIAN KEYBOARD JME FRENCH KEYBOARD JME SWISS/G KEYBOARD JME SPANISH KEYBOARD JME PORTUGUESE KEYBOARD JME ARABIC KEYBOARD JME BELGIUM KEYBOARD JME SWEDEN KEYBOARD JME CZECH KEYBOARD JME HUNGAIAN KEYBOARD JME NORWAY KEYBOARD JME DANISH KEYBOARD JME TURKISH KEYBOARD JME CANADIAN FRENCH KEYBOARD JME BRAZILIAN PROTUGESE KEYBOARD JME RUSSIAN KEYBOARD JME TRADITIONAL CHINESE KEYBOARD JME THAI	KB.A1005.001 KB.A1005.002 KB.A1005.003 KB.A1005.004 KB.A1005.005 KB.A1005.006 KB.A1005.007 KB.A1005.008 KB.A1005.009 KB.A1005.010 KB.A1005.011 KB.A1005.012 KB.A1005.013 KB.A1005.014 KB.A1005.015 KB.A1005.016 KB.A1005.017 KB.A1005.018 KB.A1005.019 KB.A1005.020 KB.A1005.021	
	Heatsink		
		THERMAL MODULE	60.A10V7.007
		N-B HEAT SINK	34.A09V7.001
	Rubber		
		LCD COVER RUBBER	47.A10V7.001
		LCD CUSHION RUBBER	47.A10V7.002
		BASE RUBBER FOOT	47.A10V7.003

Picture	Partname And Description	Part Number
Screws		
	SCREW K2*5-BNI	86.T25V7.019
	SCREW NUT-I/O	86.A03V7.001
	SCREW M2.5*4L-BZN-NYLOK	86.A03V7.006
	SCREW B1.7*2.5TA-BNIH	86.A03V7.008
	SCREW M2*3L-NI-NYLOK	86.A03V7.012
	SCREW M1.7*5	86.A10V7.001
	SCREW M1.6*3.0-NI	86.A10V7.002
	SCREW M2.0*2.0-BZN	86.A10V7.003
	SCREW M2*4L NI-NYLOK	86.A10V7.004
	SCREW M2*7L-NI-NYLOK	86.A10V7.005
	SCREW M2.5*7L-BNI-NYLOK	86.A10V7.006
	SCREW M2.5*3L-BNI-NYLOK	86.A10V7.007
	SCREW M2.5*3L-NI-NYLOK	86.A10V7.008
	SCREW M2*4L BZN-NYLOK	86.A10V7.009
	SCREW M2.5*5L-NI-NYLOK	86.A10V7.010
	SCREW M2.5*6L-NI-NYLOK	86.A10V7.011
	SCREW M3*2.8L-NI-NYLOK	86.A10V7.012
	SCREW M2.5*H3.0*D4.2	86.A10V7.013



# Model Definition and Configuration

## Aspire 1350 series

Model Number	CPU	LCD	ODD	Memory	HDD	Battery	Wireless LAN
1351X	AMD Athlon XP-M 2000+	14.1" XGA	CD-ROM	128M	20G	NiMH/ Li-Ion	N/A
1351FX	AMD Athlon XP-M 2000+	14.1" XGA	CD-ROM	128M/ 256M	20G	NiMH/ Li-Ion	N/A
1351FXV	AMD Athlon XP-M 2000+	14.1" XGA	CD-ROM	128M	20G	Li-Ion	N/A
1351FXC	AMD Athlon XP-M 2000+	14.1" XGA	DVD/CD-RW combo	256M	30G	Li-Ion	N/A
1351XC	AMD Athlon XP-M 2000+	14.1" XGA	DVD/CD-RW combo	256M	30G	Li-Ion	N/A
1351LC	AMD Athlon XP-M 2000+	15.0" XGA	DVD/CD-RW combo	256M	30G	Li-Ion	N/A
1351LM	AMD Athlon XP-M 2000+	15.0" XGA	DVD-RW	256M	40G	Li-Ion	N/A
1353LC	AMD Athlon XP-M 2400+	15.0" XGA	DVD/CD-RW combo	256M/ 2*256M	30G/ 40G	Li-Ion	N/A
1353LM	AMD Athlon XP-M 2400+	15.0" XGA	DVD-RW	2*256M	40G	Li-Ion	N/A
1355LC	AMD Athlon XP-M 2600+	15.0" XGA	DVD/CD-RW combo	256M/ 2*256M	30G/ 40G	Li-Ion	N/A
1355LM	AMD Athlon XP-M 2600+	15.0" XGA	DVD-RW	2*256M	40G	Li-Ion	N/A
1356LC	AMD Athlon XP-M 2800+	15.0" XGA	DVD/CD-RW combo	2*256M	40G	Li-Ion	N/A
1356LMi	AMD Athlon XP-M 2800+	15.0" XGA	DVD-RW	2*256M	40G	Li-Ion	11b







# Test Compatible Components

---

This computer's compatibility is tested and verified by Acer's internal testing department. All of its system functions are tested under Windows XP Home environment.

Refer to the following lists for components, adapter cards, and peripherals which have passed these tests. Regarding configuration, combination and test procedures, please refer to the Aspire 1350 Compatibility Test Report released by the Acer Mobile System Testing Department.

# Microsoft Windows XP (Home) Environment Test

Item	Specifications
Display	Philips 4CM8294/17T (DDC, Energy Star) SNI MCM1703 (DDC, Energy Star) NEC C&C-15R1 ViewSonic GS771
PC Card	
Modem Card	Xircom CreditCard Modem 56 (CM-56) Xircom CreditCard Modem 56 (CM-56G) 3Com 56K Modem (XJ1560)
LAN Card	D-Link Fast Ethernet DFE-650 D-Link CardBus DFE-660 3COM 10/100 16Bit LAN Card (3CCFE574BT) 3COM 10/100CardBus LAN Card (3CCFE575BT) Xircom CreditCard Ethernet 10/100 (CE3B-100BTX) Xircom CardBus Ethernet II 10/100 (CBE2-100BTX)
SCSI	Adaptec Slim SCSI APA-1450A Card Adaptec Slim SCSI 1480 CardBus UltraSCSI Card
LAN+Modem Card	3COM 10/100 LAN+56K Modem Card (3CCFE556B) Xircom CreditCard Ethernet+Modem 56K (CEM56-100)
ATA Card	KingMax 40MB Compact Flash 96MB
Wireless LAN Card	Gemtek Wireless LAN Card
BlueTooth Card	3Com BlueTooth Card
Modem Adapters	
Modem	Xircom Winglobal Carbus Modem 56K
I/O Peripheral	
I/O - Parallel (Printer)	HP Laser Jet 5M HP Desk Jet 890C IOMega ZIP (LPT Port)
I/O - USB (Keyboard)	Microsoft Internet Keyboard Pro Gateway Keyboard SK-9910U Gateway Keyboard SK-9926
I/O - USB (Mouse)	Microsoft Optical USB Mouse Lotitech Wheel Mouse Acer USB Mouse M012B0
I/O-USB (Camera)	Microtek EyeStar U2S PC Camera USC-1
I/O-USB (HDD)	Argosy HDD
I/O-USB (CD-ROM)	IOMega ZIP CD650
I/O-USB (Printer)	HD DeskJet 840C
I/O-USB (FDD)	MIC USB FDD YD-8U10
I/O-USB (LAN)	3Com USB LAN
I/O-USB (Zip)	Iomega USB ZIP
I/O-USB (Scanner)	HP ScanJet 5200
I/O-USB (Speaker)	Philips USB speaker
I/O - USB (Speaker)	Panasonic USB Speaker EAB-MPC57 Phillips DSS350 Speaker

---

Item	Specifications
Audio Jacks	JS-100 Jazz 3D Speaker SONY Earphone MDR-CD60 Microsoft Microphone
Microphone	Condenser MIC. Dynamic MIC.



# Online Support Information

---

This section describes online technical support services available to help you repair your Acer Systems.

If you are a distributor, dealer, ASP or TPM, please refer your technical queries to your local Acer branch office. Acer Branch Offices and Regional Business Units may access our website. However some information sources will require a user i.d. and password. These can be obtained directly from Acer CSD Taiwan.

Acer's Website offers you convenient and valuable support resources whenever you need them.

In the Technical Information section you can download information on all of Acer's Notebook, Desktop and Server models including:

- Service guides for all models
- User's manuals
- Training materials
- Bios updates
- Software utilities
- Spare parts lists
- TABs (Technical Announcement Bulletin)

For these purposes, we have included an Acrobat File to facilitate the problem-free downloading of our technical material.

Also contained on this website are:

- Detailed information on Acer's International Traveler's Warranty (ITW)
- An overview of all the support services we offer, accompanied by a list of telephone, fax and email contacts for all your technical queries.

We are always looking for ways to optimize and improve our services, so if you have any suggestions or comments, please do not hesitate to communicate these to us.

