

Aspire 1500 Series

Service Guide

Service guide files and updates are available on the ACER/CSD web; for more information, please refer to <http://csd.acer.com.tw>

SERVICE GUIDE PART NO.:

PRINTED IN TAIWAN

Revision History

Please refer to the table below for the updates made on Aspire 1450 service guide.

Date	Chapter	Updates

Copyright

Copyright © 2003 by Acer Incorporated. All rights reserved. No part of this publication may be reproduced, transmitted, transcribed, stored in a retrieval system, or translated into any language or computer language, in any form or by any means, electronic, mechanical, magnetic, optical, chemical, manual or otherwise, without the prior written permission of Acer Incorporated.

Disclaimer

The information in this guide is subject to change without notice.

Acer Incorporated makes no representations or warranties, either expressed or implied, with respect to the contents hereof and specifically disclaims any warranties of merchantability or fitness for any particular purpose. Any Acer Incorporated software described in this manual is sold or licensed "as is". Should the programs prove defective following their purchase, the buyer (and not Acer Incorporated, its distributor, or its dealer) assumes the entire cost of all necessary servicing, repair, and any incidental or consequential damages resulting from any defect in the software.

Acer is a registered trademark of Acer Corporation.

Intel is a registered trademark of Intel Corporation.

Pentium and Pentium II/III are trademarks of Intel Corporation.

Other brand and product names are trademarks and/or registered trademarks of their respective holders.

Conventions

The following conventions are used in this manual:

SCREEN MESSAGES	Denotes actual messages that appear on screen.
NOTE	Gives bits and pieces of additional information related to the current topic.
WARNING	Alerts you to any damage that might result from doing or not doing specific actions.
CAUTION	Gives precautionary measures to avoid possible hardware or software problems.
IMPORTANT	Reminds you to do specific actions relevant to the accomplishment of procedures.

Preface

Before using this information and the product it supports, please read the following general information.

1. This Service Guide provides you with all technical information relating to the BASIC CONFIGURATION decided for Acer's "global" product offering. To better fit local market requirements and enhance product competitiveness, your regional office MAY have decided to extend the functionality of a machine (e.g. add-on card, modem, or extra memory capability). These LOCALIZED FEATURES will NOT be covered in this generic service guide. In such cases, please contact your regional offices or the responsible personnel/channel to provide you with further technical details.
2. Please note WHEN ORDERING FRU PARTS, that you should check the most up-to-date information available on your regional web or channel. If, for whatever reason, a part number change is made, it will not be noted in the printed Service Guide. For ACER-AUTHORIZED SERVICE PROVIDERS, your Acer office may have a DIFFERENT part number code to those given in the FRU list of this printed Service Guide. You MUST use the list provided by your regional Acer office to order FRU parts for repair and service of customer machines.

Chapter 1	System Introduction	1
	Features	1
	System Block Diagram	3
	Board Layout	4
	Top View	4
	Bottom View	5
	Panel	6
	Front Panel	6
	Left Panel	7
	Right Panel	8
	Rear Panel	9
	Bottom Panel	10
	Indicators	11
	Understanding the icons	12
	Keyboard	13
	Special keys	13
	Hot Keys	15
	Hardware Specifications and Configurations	18
Chapter 2	System Utilities	28
	BIOS Setup Utility	28
	Navigating the BIOS Utility	29
	Information	30
	Main	31
	Advanced	33
	Security	35
	Boot	39
	Exit	40
	BIOS Flash Utility	41
Chapter 3	Machine Disassembly and Replacement	42
	General Information	43
	Before You Begin	43
	Disassembly Procedure Flowchart	44
	Removing the Battery	46
	Removing the Memory Module	47
	Removing the Modem Board	48
	Removing the Hard Disk Drive Module	49
	Removing the LCD Module	50
	Disassembling the LCD Module	53
	Disassembling the Main Unit	57
	System Upgrade Procedure	67
	Assembling the Main Unit	68
	Assembling the LCD Module	77
	Installing the LCD Module	81
	Installing the Hard Disk Drive Module	84
	Installing the Modem Board	85
	Installing the Memory Module	86
	Installing the Battery	87
Chapter 4	Troubleshooting	88
	System Check Procedures	89
	External Diskette Drive Check	89
	External CD-ROM Drive Check	89

Table of Contents

Keyboard or Auxiliary Input Device Check	89
Memory check	89
Power System Check	90
Touchpad check	91
Power-On Self-Test (POST) Error Message	92
Index of Error Messages	93
POST Codes	95
Index of Symptom-to-FRU Error Message	99
Intermittent Problems	103
Undetermined Problems	104
Chapter 5 Jumper and Connector Locations	106
Top View	106
Bottom View	107
Chapter 6 FRU (Field Replaceable Unit) List	108
Exploded Diagram	109
Appendix A Model Definition and Configuration	119
Aspire 1500 Series	119
Appendix B Test Compatible Components	120
Microsoft®Windows® XP Environment Test	121
Appendix C Online Support Information	124

Table of Contents

System Introduction

Features

This computer was designed with the user in mind. Here are just a few of its many features:

Performance

- The AMD Athlon™ 64 processor 3000+~3400+
- AMD Hyper Transport technology
- Two memory slots supporting 333 MHz DDR, upgradeable to 2GB (Memory modules are strictly required to be JEDEC compliant)
- Dual 200-pin soDIMM sockets
- RC2700 DDR SDRAM (Double Date Rate-Synchronous Dynamic Random Access Memory) support
- High-capacity, Enhanced-IDE hard disk

Display

- The 14.1" XGA (1024X768 resolution), or 15.0" SXGA+ (1400X1050 resolution) TFT LCD panel provides a large viewing area for maximum efficiency and ease-of-use
- 3D graphics support
- Support simultaneous display between LCD and CRT display
- S-video for output to television or display device that supports S-video input
- "Automatic LCD dim" feature that automatically selects the best setting for the display in order to conserve power
- DualView™ support

Multimedia

- High-speed built-in optical drive: CD-ROM, DVD-ROM, DVD/CD-RW combo, or DVD-Dual
- MS DirectSound compatible
- Built-in dual speakers

Connectivity

- Integrated Gigabit Ethernet connection
- Built-in 56Kbps fax/data modem
- Four universal serial bus (USB 2.0) ports
- One IEEE 1394 port
- IEEE 802.11g or IEEE 802.11a/g Wireless LAN (manufacturing option)
- Bluetooth option (manufacturing option)

Human-centric design

- All-in-one design (incorporating hard drive, optical drive and floppy disk drive)
- Rugged, yet extremely portable, construction
- Stylish appearance
- Full-size keyboard with four programmable launch keys

-
- Comfortable palm rest area with well-positioned touchpad

Expansion

- PC card slot enables a range of add-on options
- Upgradeable hard disk and memory modules

I/O Ports

- Two Type II or one Type III PC CardBus (PCMCIA) slot
- One IEEE 1394 port
- One FIR port
- One RJ-11 modem jack (V.90/V.92, 56K)
- One RJ-45 network jack (Gigabit Ethernet)
- One DC-in port
- One parallel port (ECP/EPP)
- One S-video port
- One external monitor port
- One microphone-in jack (3.5mm mini jack)
- One headphone jack (3.5mm mini jack)
- Four USB 2.0 ports

Board Layout

Top View

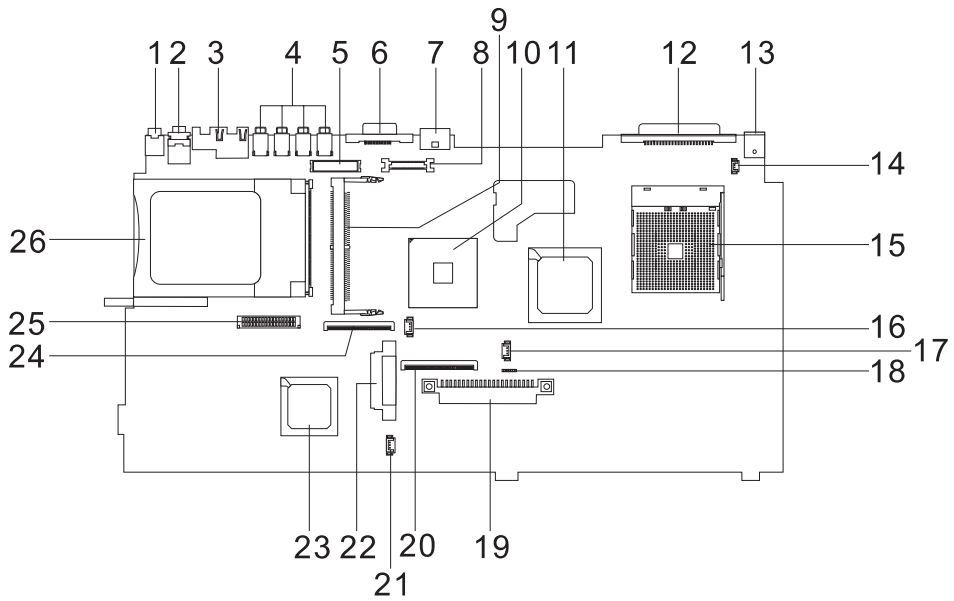

- | | | | |
|----|------------------------------|----|---|
| 1 | Line-in/MIC Connector | 14 | Switch Cable Connector (LCD Lid Switch) |
| 2 | Line-out/S/PDIF Connector | 15 | CPU Socket |
| 3 | LAN Connector | 16 | RTC Battery Connector |
| 4 | USB Connector | 17 | Fan Cable Connector |
| 5 | LCD Inverter Cable Connector | 18 | Touchpad Cable Connector |
| 6 | CRT Connector | 19 | HDD Connector |
| 7 | TV-out Connector | 20 | Keyboard Connector |
| 8 | LCD Coaxial Cable Connector | 21 | Speaker Connector |
| 9 | Mini PCI Socket | 22 | ODD Connector |
| 10 | VGA Chip | 23 | South Bridge |
| 11 | North Bridge | 24 | FDD Connector |
| 12 | Printer Connector | 25 | Launch Cable Connector |
| 13 | AC Adapter Connector | 26 | PCMCIA Slot |

Bottom View

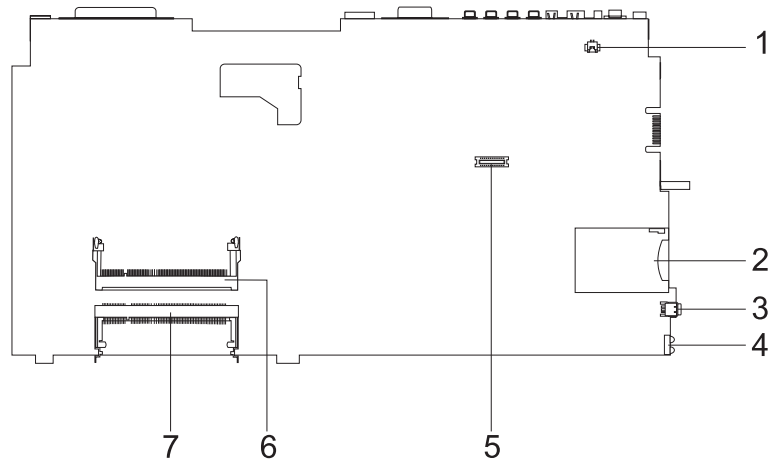

- 1 Modem Cable Connector
- 2 Card Reader Slot
- 3 IEEE 1394 Connector
- 4 IR Connector
- 5 Modem Board Connector
- 6 DIMM Socket 1
- 7 DIMM Socket 2

Panel

Ports allow you to connect peripheral devices to your computer as you would with a desktop PC.

Front Panel



#	Item	Description
1	Display screen	Also called LCD (Liquid Crystal Display), displays computer output.
2	Status indicators	LEDs (Light Emitting Diodes) that turn on and off to show the status of the computer and its functions and components.
3	Launch Keys	Buttons for launching frequently used programs. See "Launch keys" on page 17 for more details.
4	Power switch	Turns on the computer power.
5	Palmrest	Comfortable support area for your hands when you use the computer.
6	Click buttons (left, center and right)	The left and right buttons function like the left and right mouse buttons, the center button serves as a scroll up/down button.
7	Touchpad	Touch-sensitive pointing device which functions like a computer mouse.
8	Keyboard	Inputs data into your computer.
9	Ventilation Slot	Enables the computer to stay cool, even after the prolonged use.

Left Panel



#	Icon	Item/ Port	Description
1		PC Card slots	Support two Type II or one Type III CardBus PC Card(s).
2		Eject buttons	Eject PC card(s) from the card slots.
3		3-in-1 card reader	Supports Secure Digital (SD), MultiMedia Card (MMC) and Memory Stick (MS) formats
4		IEEE 1394 port	Connects to IEEE 1394 devices
5		Infrared port	Interfaces with infrared devices (e.g., infrared printer, IR-aware computer).
6		LED indicator	Lights up when the optical drive is active.
7		Eject button	Ejects the optical drive tray from the drive.
8		Emergency eject slot	Ejects the optical drive tray when the computer is turned off. There is a mechanical eject button on the CD-ROM or DVD-ROM drive. Simply insert the tip of a pen or paperclip and push to eject the tray.
9		Optical drive	Internal optical drive; accepts CDs or DVDs depending on the optical drive type.
10		Speaker	Delivers stereo audio output.

Right Panel

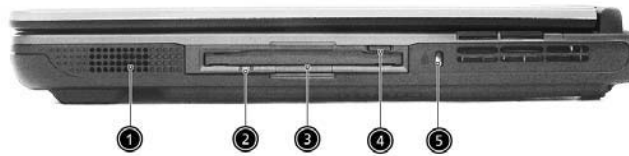







#	Icon	Item/ Port	Description
1		Speaker	Delivers stereo audio output.
2		Floppy activity indicator	LED (light-emitting diode) that turns on and off when the floppy is active.
3		Floppy drive	Internal diskette drive; accepts 3.5-inch diskettes.
4		Floppy disk eject button	Push this button to eject the floppy disk.
5		Security keylock	Connects to a Kensington-compatible computer security lock.

Rear Panel

I



#	Icon	Port	Description
1		Power Jack	Connects to an AC adapter
2		Parallel port	Connects to a parallel device (e.g., parallel printer)
		S-video port	Connects to a television or display device with S-video input.
3		External display port	Connects to a display device (e.g., external monitor, LCD projector) and displays up to 16M colors at 1024x768 resolution
4		Four USB port (four)	Connects to any Universal Serial Bus devices(e.g., USB mouse, USB camera).
5		Network jack	Connects to an Ethernet 10/100-based network
6		Modem jack	Connects to the phone line
7		Speaker/line-out/ headphone jack	Accepts audio line-in devices (e.g., audio CD player, stereo walkman).
8		Line-in/mic-in jack	Acceptis audio line-in devices (e.g., audio CD player and stereo walkman).

Bottom Panel









#	Item	Description
1	Battery bay	Houses the computer's battery pack.
2	Battery release latch	Unlatches the battery to remove the battery pack.
3	Memory compartment	Houses the computer's main memory.

Indicators

The computer has six easy-to-read status icons on the right of the display screen.



The Power and Standby status icons are visible even when you close the display cover so you can see the status of the computer while the cover is closed.

#	Icon	Function	Description
1		Wireless communication button	Lights when the Wireless LAN capability is enabled
2		Power	Lights when the computer is on.
3		Sleep	Lights when the computer enters Standby mode and blinks when it enters into or resumes from hibernation mode.
4		Media Activity	Lights when the floppy drive, hard disk or optical drive is active.
5		Battery Charge	Lights when the battery is being charged.
6		Caps Lock	Lights when Caps Lock is activated.
7		Num Lock (Fn-F11)	Lights when Numeric Lock is activated.

Understanding the icons

When the cover of your computer is closed, 2 easy-to-read icons are shown, indicating which state or feature is enabled or disabled.



#	Icon	Function	Description
1		Power	Lights up when the computer is on.
2	Z^Z	Sleep	Lights when the computer enters Standby mode and blinks when it enters into or resumes from hibernation mode.

Keyboard







The keyboard has full-sized keys and an embedded keypad, separate cursor keys, two Windows keys and twelve function keys.

Special keys

Lock keys

The keyboard has three lock keys which you can toggle on and off.



Lock key	Description
Caps Lock 	When  is on, all alphabetic characters typed are in uppercase.
Num Lock (Fn-F11) 	When  is on, the embedded keypad is in numeric mode. The keys function as a calculator (complete with the arithmetic operators), -, *, and /). Use this mode when you need to do a lot of numeric data entry. A better solution would be to connect an external keypad.
Scroll Lock (Fn-F12) 	When  is on, the screen moves one line up or down when you press the up or down arrow keys respectively.  does not work with some applications.

Embedded numeric keypad

The embedded numeric keypad functions like a desktop numeric keypad. It is indicated by small characters located on the upper right corner of the keycaps. To simplify the keyboard legend, cursor-control key symbols are not printed on the keys.











Desired access	Num lock on	Num lock off
Number keys on embedded keypad	Type numbers in a normal manner.	
Cursor-control keys on embedded keypad	Hold Shift while using cursor-control keys.	Hold Fn while using cursor-control keys.
Main keyboard keys	Hold Fn while typing letters on embedded keypad.	Type the letters in a normal manner.

NOTE: If an external keyboard or keypad is connected to the computer, the Num Lock feature automatically shifts from the internal keyboard to the external keyboard or keypad.

Windows keys

The keyboard has two keys that perform Windows-specific functions.



Keys	Description
Windows logo key 	Start button. Combinations with this key perform shortcut functions. Below are a few examples:  + Tab (Activates next taskbar button)  + E (Explores My Computer)  + F (Finds Document)  + M (Minimizes All)  +  + M (Undoes Minimize All)  + R (Displays the Run... dialog box)
Application key 	Opens a context menu (same as a right-click).











Hot Keys

The computer employs hot keys or key combinations to access most of the computer's controls like screen contrast and brightness, volume output and the BIOS Utility.

To activate hot keys, press and hold the **Fn** key before pressing the other key in the hot key combination.



Hot Key	Icon	Function	Description
Fn-F1	?	Hotkey help	Displays a list of the hotkeys and their functions.
Fn-F2		Setup	Accesses the notebook configuration utility.
Fn-F3		Power Management Scheme Toggle	Switches between the power management scheme used by the computer (function available if supported by operating system).
Fn-F4	Zz	Sleep	Puts the computer in Sleep mode.
Fn-F5		Display toggle	Switches display output between the display screen, external monitor (if connected) and both the display screen and external monitor.
Fn-F6		Screen blank	Turns the display screen backlight off to save power. Press any key to return.
Fn-F7		Touchpad Toggle	Turns the internal touchpad on and off.
Fn-F8		Speaker on/off	Turns the speakers on and off; mutes the sound.
Fn-↑		Volume up	Increases the sound volume.
Fn-↓		Volume down	Decreases the sound volume.
Fn-→		Brightness up	Increases the screen brightness.

Hot Key	Icon	Function	Description
Fn- 		Brightness down	Decreases the screen brightness.
Fn- 	Pg Up 	Home	Functions as the  key.
Fn- 	Pg Dn 	End	Functions as the  key.
 Gr-Euro		Euro	Types the Euro symbol.

The Euro symbol

If your keyboard layout is set to United States-International or United Kingdom or if you have a keyboard with a European layout, you can type the Euro symbol on your keyboard.

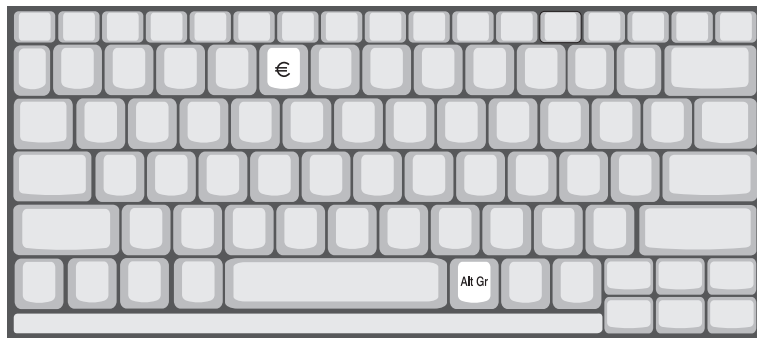

NOTE: for US keyboard users: The keyboard layout is set when you first set up Windows. For the Euro symbol to work, the keyboard layout has to be set to United States-international.

To verify the keyboard type:

1. Click on **Start, Control Panel**.
2. Double-click on **Regional and Language Options**.
3. Click on the **language** tab and click on **Details**.
4. Verify that the keyboard layout used for "EN English (United States) is set to United States-International.

If not, select and click on **ADD**, then select **United States-International** and click on **OK**.

5. Click on **OK**.





To type the Euro symbol:

1. Locate the Euro symbol on your keyboard.
2. Open a text editor or word processor.
3. Hold  Gr and press the Euro symbol.

Launch Keys

Located at the top of the keyboard are five buttons. These buttons are called launch keys. They are designated as wireless LAN/Bluetooth, Web Browser button, mail button, P1 and P2. By default, P1 and P2 are users programmable. The Web Browser button, by default, is used to launch the internet browser. The mail button is used to launch the e-mail application. The LED of the mail button will flash when the user has received an incoming email.



#	Icon	Function	Description
1		Mail	Email application
2		Web browser	Internet browser application
3	P1	P1	User-programmable
4	P2	P2	User-programmable
5		Bluetooth	Starts Bluetooth functionality and indicates that Bluetooth is enabled.
6		Wireless	Opens (optional) wireless connectivity and indicates status of (optional) wireless communication.

Hardware Specifications and Configurations

System Board Major Chip

Item	Controller
System core logic	ADM CPU+VIA Apollo K8T800
Super I/O controller	NS PC87392
Audio controller	VIA VT1612A
Video controller	ATI MOBILITY™ RADEON™ 9600
Hard disk drive controller	VIA VT8235
Keyboard controller	Mitsubishi LPC keyboard controller M38857
CardBus Controller	RICOH R5C554

Processor

Item	Specification
CPU type	AMD Athlon™ 64 processor at 3000+ or 3200+
CPU package	754-pin micro PGA, lidded
CPU core voltage	Low speed: 0.8V High speed: 1.5V
CPU I/O voltage	1.2V

BIOS

Item	Specification
BIOS vendor	Phoenix BIOS
BIOS Version	AS1500 V1.00
BIOS ROM type	Flash ROM
BIOS ROM size	1M
BIOS package	32 Pin PLCC
Supported protocols	ACPI 2.0 (if available, at least 1.0b), SMBIOS 2.3, PCI 2.2, Boot Block, PXE 2.0, Mobile PC2001, Hard Disk Password, INT 13h Extensions, PCI Bus Power Management interface Specification, El Torito-Bootable CD-ROM Format Specification V1.0, Simple Boot Flag 1.0
BIOS password control	Set by switch, see SW1 settings

Second Level Cache

Item	Specification
Cache controller	Built-in CPU
Cache size	1M
1st level cache control	Always Enabled
2nd level cache control	Always Enabled
Cache scheme control	Fixed-in write back

System Memory

Item	Specification
Memory controller	AMD Athlon™ 64 processor
Onboard memory size	0MB

System Memory

Item	Specification
DIMM socket number	2 Sockets
Supports memory size per socket	128MB
Supports maximum memory size	2048MB
Supports DIMM type	DDR-DRAM
Supports DIMM Speed	333 MHz
Supports DIMM voltage	2.5 V/1.25V
Supports DIMM package	200-pin so-DIMM
Memory module combinations	You can install memory modules in any combinations as long as they match the above specifications .

Memory Combinations

Slot 1	Slot 2	Total Memory
0MB	256MB	256MB
0MB	512MB	512MB
0MB	1024MB	1024MB
256MB	0MB	256MB
256MB	256MB	512MB
256MB	512MB	768MB
256MB	1024MB	1280MB
512MB	0MB	512MB
512MB	256MB	768MB
512MB	512MB	1024MB
512MB	1024MB	1536MB
1024MB	0MB	1024MB
1024MB	256MB	1280MB
1024MB	512MB	1536MB
1024MB	1024MB	2048MB

Above table lists some system memory configurations. You may combine DIMMs with various capacities to form other combinations.

LAN Interface

Item	Specification
Chipset	Broadcom BCM5788MKFB
Supports LAN protocol	10/100/1000Mbps
LAN connector type	RJ45
LAN connector location	Rear side

Modem Interface

Item	Specification
Chipset	CS1037 Internal Agere Scorpio chipset (Scorpio+CSP1037B)
Fax modem data baud rate (bps)	14.4K
Data modem data baud rate (bps)	56K
Supports modem protocol	V.90/V.92MDC
Modem connector type	RJ11

Modem Interface

Item	Specification
Modem connector location	Rear side

Floppy Disk Drive Interface

Item	Specification		
Vendor & model name	Panasonic JU-226A033		
Floppy Disk Specifications			
Media recognition	2DD (720KB)	2HD (1.2 MB, 3 mode)	2HD (1.44MB)
Sectors/track	9	15	18
Tracks	80	80	80
Data transfer rate (Kbit/s)	1 MB	1.6 MB	2 MB
Rotational speed (RPM)	300	360	300
Read/write heads	2		
Encoding method	MFM		
Power Requirement			
Input Voltage (V)	+5V		

Hard Disk Drive Interface

Item	Specification			
Vendor & Model Name	TOSHIBA PLUTO MK4025GAS	HGST MORAGA IC25N060ATMR04-0 08K0634	TOSHIBA NEPTUNE MK6021GAS	HGST MORAGA HTS548060M9AT00 08K0638
Capacity (MB)	40000	60000	60000	60000
Bytes per sector	512	512	512	512
Logical heads	16	16	16	16
Logical sectors	63	63	63	63
Drive Format				
Logical cylinders	16383	16383	16383	16383
Physical read/write heads	2	3	4	4
Disks	1	2	2	2
Spindle speed (RPM)	4200RPM	4200RPM	4200RPM	5400RPM
Performance Specifications				
Buffer size	8MB	8MB	2MB (2048KB)	8MB
Interface	ATA-6	ATA-6	ATA-5	ATA-6
Data transfer, rate (host~buffer, Mbytes/s)	100 MB/Sec	100 MB/Sec	100 MB/Sec	100 MB/Sec
DC Power Requirements				
Voltage tolerance	5 +/- 5%	5 +/- 5%	5 +/- 5%	5 +/- 5%

DVD-RW Interface

Item	Specification	
Vendor & model name	DVD-RW MODULE PIONEER DVR-K12D	
Performance Specification	With CD Diskette	With DVD Diskette

DVD-RW Interface

Item	Specification	
Transfer rate (KB/sec)	Sustained: Max 3.6Mbytes/sec	Sustained: Max 10.8Mbytes/sec
Data Buffer Capacity	128 KBytes	
ATAPI Interface	SFF-8020i, SFF8090 Ver5	
Applicable disc format	Supports KODAK Photo CD single and Multi-session Supports CD Extra (CD PLUS) Supports Mixed CD Supports Video CD Supports to read/write CD-R discs Supports to read/write CD-RW discs Supports CD text data read/write Supports to read DVD-ROM Supports to read/write DVD-R Ver. 2.00 for General Supports to read/write DVD-RW Ver.1.0 & 1.1	
Loading mechanism	Load: Manual Release: (a) Electrical Release (Release Button) (b) Release by ATAPI command (c) Emergency Release	
Power Requirement		
Input Voltage	5 V +/- 5 % (Operating)	

Audio Interface

Item	Specification
Audio Controller	VIA VT1612A
Audio onboard or optional	Built-in
Mono or Stereo	Stereo
Resolution	18 bit stereo full duplex
Compatibility	AC97 2.2 S/PDIF extension compliant codec
Sampling rate	1Hz resolution VSR (Variable Sampling Rate)
Internal microphone	Yes
Internal speaker / Quantity	Yes
Supports PnP DMA channel	DMA channel 0 DMA channel 1
Supports PnP IRQ	IRQ10, IRQ11

Video Interface

Item	Specification
Vendor & Model Name	ATI RADEON 9600
Video memory size	128MB
Chip voltage	Core / 2.5V, 1.5V,
Supports ZV (Zoomed Video) port	NO
Graph interface	8X AGP (Accelerated Graphic Port) Bus
Maximum resolution LCD	1600X1200 (UXGA)
Maximum resolution CRT	2048X1536@60HZ

Video Resolutions Mode

Monitor Resolution	Hz
2D Display Mode	
640x480	120
800x600	120
1024x768	120
1152x864	120
1280x1024	120
1600x1200	85
1920x1080*16:9	75
1920x1200	75
1920x1440	75
2048x1536	60

Resolution, colors and maximum refresh rate (Hz) in 256, 65K or 16.7M colors.

NOTE: 16:9 aspect ratio monitors are supported on 1920x1080 and 848x480 on Windows(R)XP, Windows(R) 2000 and Windows(R)ME. The complete list of resolutions depends on the driver version and operating system. NOTE: resolutions are limited by the performance of the attached monitor.

Parallel Port

Item	Specification
Parallel port controller	NS PC87392
Number of parallel port	1
Location	Rear side
Connector type	25-pin D-type
Parallel port function control	Enable/Disable by BIOS Setup
Supports ECP/EPP	Yes (set by BIOS setup)
Optional ECP DMA channel (in BIOS Setup)	DMA channel 1 and 3
Optional parallel port I/O address (in BIOS Setup)	378, 278, 3BC
Optional parallel port IRQ (in BIOS Setup)	IRQ7, IRQ5

USB Port

Item	Specification
USB Compliancy Level	2.0
OHCI	USB 2.0
Number of USB port	4
Location	Rear side
Serial port function control	Enable/Disable by BIOS Setup

PCMCIA Port

Item	Specification
PCMCIA controller	RICOH R5C554
Supports card type	Type II, Type III
Number of slots	Two type II, one type III
Access location	Left side
Supports ZV (Zoomed Video) port	Yes

PCMCIA Port

Item	Specification
Supports 32 bit CardBus	Yes (IRQ17)

Keyboard

Item	Specification
Keyboard controller	Mitsubishi LPC keyboard controller M38857
Keyboard vendor	DARFON
Total number of keypads	84-/85- key
Windows keys	Yes
Internal & external keyboard work simultaneously	Yes

Battery

Item	Specification
Vendor & model name	SANYO
Battery Type	Li-ION
Pack capacity	6600mAH
Cell voltage	3.8V / 1.2V
Number of battery cell	12
Package configuration	4529 / 8S
Package voltage	41.8V / 9.6V

DC-AC LCD Inverter

Item	Specification
Vendor & model name	Ambit
Input voltage (V)	8 ~ 21V
Input current (mA)	1A (max.)
Output voltage (Vrms, no load)	1400Vrms
Output voltage frequency (kHz)	40 ~ 70KHz
Output Current/Lamp	5.5 mA ~ 6.5mA

NOTE: DC-AC inverter is used to generate very high AC voltage, then support to LCD CCFT backlight user, and is also responsible for the control of LCD brightness. Avoid touching the DC-AC inverter area while the system unit is turned on.

NOTE: There is an EEPROM in the inverter, which stores its supported LCD type and ID code. If you replace a new inverter or replace the LCD with a different brand, use Inverter ID utility to update the ID information.

LCD

Item	Specification
Vendor & model name	15" AU B150PG01
Mechanical Specifications	
LCD display area (diagonal, inch)	15.0
Active Area (mm)	304.5x228.4

LCD

Item	Specification
Pixel Pitch (mm)	0.2175
Display technology	TFT
Resolution(pixel)	SXGA+ (1400x1050)
Support colors	262K
View Angle (U/D/L/R)	10/30/40/40
Optical Specification	
Brightness control	Keyboard hotkey
Contrast control	None
Brightness (cd/m sq.)	150
Contrast Ratio	250:1
Response Time (ms) (at 25 dec C)	50
Backlight	1 CCFL
Electrical Specification	
Supply voltage for LCD display (V)	3.3 (typ.)

AC Adapter

Item	Specification
Vendor & model name	Liton
Input Requirements	
Maximum input current (A, @90Vac, full load)	1.5 A @ 110Vac 1.0 A @ 240Vac
Nominal frequency (Hz)	50-60
Frequency variation range (Hz)	47-63
Input voltage range (Vrms)	90-270
Inrush current	The maximum inrush current will be less than 50A and 100A when the adapter is connected to 115Vac and 230Vac respectively.
Efficiency	It should provide an efficiency of 80% minimum, when measured at maximum load under 115Vac.
Output Ratings (CV mode)	
DC output voltage	19V
Noise + Ripple	300mVp-pmax (20 MHz bandwidth)
Load	0(min) 3.16A(max)
Output Ratings (CC mode)	
DC output voltage	19V +/-1.0V for CV mode
Constant current mode	3.6 +/- 0.3A
Dynamic Output Characteristics	
Turn-on delay time	3 sec (@ 115Vac)
Hold up time	5ms (@115Vac, Full load)
Over Voltage Protection (OVP)	24V
Short circuit protection	3.9A max can be protected and output can be shorted without damage
Electrostatic discharge (ESD)	15KV (at air discharge) 8KV (at contact discharge)
Dielectric Withstand Voltage	
Primary to secondary	3000Vac
Leakage current	0.25 mA max. (@ 254Vac, 60Hz)

AC Adapter

Item	Specification
Regulatory Requirements	<p>Safety Requirements:</p> <ol style="list-style-type: none"> 1.The subject product rated 100-120V 60Hz must be listed under UL 1950 and certified with SCA Standard C22.2 No.950. 2.The subject product rated 200-240V 50Hz must comply with low voltage directive 73/23EEC. <p>EMI Requirements:</p> <ol style="list-style-type: none"> 1.The subject product rated 100-120V 60Hz must meet the EMI requirements of FCC part 15, Subpart B for Class B Digital Device and get FCC Certification before marketing into USA and Canada. 2.The subject product rated 200-240V 50Hz must meet the EMC Directive 89/336/EEC. 3.The subject product rated 100-120V must meet the VCCI-2 EMI requirements.

Power Management

Power Saving Mode	Phenomenon
<p>Standby Mode Enter Standby Mode when</p> <ol style="list-style-type: none"> 1.Standby/Hibernation hot-key is pressed and system is not ready to enter Hibernation mode. 2.System standby/ Hibernation timer expires and system is not ready to enter Hibernation mode. 	<input type="checkbox"/> The buzzer beeps <input type="checkbox"/> The Sleep indicator lights up
<p>Hibernation Mode Enter Hibernation Mode (suspend to HDD) when</p> <ol style="list-style-type: none"> 1.Hibernation hot-key is pressed and system is ready to enter Hibernation mode 2.System Hibernation timer expires and system is ready to enter Hibernation mode. 	<input type="checkbox"/> All power shuts off
<p>Display Standby Mode Keyboard, built-in touchpad, and an external PS/2 pointing device are idle for a specified period.</p>	<input type="checkbox"/> The display shuts off
<p>Hard Disk Standby Mode Hard disk is idle within a specified period of time.</p>	<input type="checkbox"/> Hard disk drive is in standby mode. (spindle turned-off)

Environmental Requirements

Item	Specification
Temperature	
Operating	+5~+35 °C
Non-operating	-20~+65 °C
Package storage	-20~+65 °C
Humidity	
Operating	20% to 80% RH, non-condensing
Non-operating	10% to 90% RH, non-condensing (Unpacked)
Non-operating	10% to 90% RH, non-condensing (Storage package)
Vibration	

Environmental Requirements

Item	Specification
Operating (unpacked)	5~25.6Hz: 0.38mm (peak to peak) 25.6~250Hz: 0.5G
Non-operating (unpacked)	5~27.1Hz: 0.6G 27.1~50Hz: 0.04mm (peak to peak) 50~500Hz: 2.0G
Non-operating (packed)	5~62.6Hz: 0.51mm (peak to peak) 62.6~500Hz: 4.0G

Mechanical Specification

Item	Specification
Dimensions	326(W) x 290(D) x 38.6(H)mm for 14.1" Model 326(W) x 290(D) x 42.9(H)mm for 15.0" Model
Weight	7.32 lbs for 14.1" TFT LCD model with battery 7.51 lbs for 15.0" TFT LCD model with battery
I/O Ports	Two Type II or one Type III PC CardBus (PCMCIA) slot, one IEEE 1394 port, one FIR port, one RJ-11 modem jack (V.90/V.92, 56K), one RJ-45 network jack (Gigabit Ethernet), one DC-in port, one parallel port (ECP/EPP), one S-video port, one external monitor port, one microphone-in jack (3.5mm mini jack), one headphone jack (3.5mm mini jack), four USB 2.0 ports
Drive Bays	One
Material	Plastic
Indicators	Power-on, Standby, Battery Status, Media Access, CapsLock and NumLock
Switch	Power

System Utilities

BIOS Setup Utility

The BIOS Setup Utility is a hardware configuration program built into your computer's BIOS (Basic Input/Output System).

Your computer is already properly configured and optimized, and you do not need to run this utility. However, if you encounter configuration problems, you may need to run Setup. Please also refer to Chapter 4 Troubleshooting when problem arises.

To activate the BIOS Utility, press **F2** during POST (when "Press <F2> to enter Setup" message is prompted on the bottom of screen).

Press **F2** to enter setup. Press <F12> during POST to enter multi-boot menu. In this menu, user can change boot device without entering BIOS SETUP Utility.

PhoenixBIOS Setup Utility					
Information	Main	Advanced	Security	Boot	Exit
<pre> CPU Type: AMD Athlon 64 DTR CPU Speed: 2000 MHz Floppy Drive: 1.44 MB 3 1/2" IDE1 Model Name: IC25N060ATMR04-0-(PM) HDD1 Serial Number: MRG326K3GLKX3H IDE2 Model Name: PIONEER DVD-RW DVR-K12RA-(SM) HDD2 Serial Number: None System BIOS Ver: AS1500 V0.16 VGA BIOS Ver: BK-ATI VER008.001.001.031 KBC Ver: 02.13.29 Serial Number: xxxxxxxxxxxxxxxxxxxxxxxx 22 Byte Asset Tag Number: N/A 32 Byte Product Name: Aspire 1500 16 Byte Manufacturer Name: Acer 16 Byte UUID: xxxxxxxx-xxxx-xxxx-xxxx-xxxxxxxxxxxx 16 Byte </pre>					
F1 Help	↑↓ Select Item	F5/F6 Change Values	F9 Setup Defaults		
Esc Exit	←→ Select Menu	Enter Select ▶ Sub-Menu	F10 Save and Exit		

Navigating the BIOS Utility

There are six menu options: Info., Main, System Devices, Security, Boot, and Exit.

Follow these instructions:

- ❑ To choose a menu, use the cursor left/right keys (← →).
- ❑ To choose a parameter, use the cursor up/down keys (↑ ↓).
- ❑ To change the value of a parameter, press F8 or F6.
- ❑ A plus sign (+) indicates the item has sub-items. Press ENTER to expand this item.
- ❑ Press ESC while you are in any of the menu options to go to the Exit menu.
- ❑ In any menu, you can load default settings by pressing F8. You can also press F6 to save any changes made and exit the BIOS Setup Utility.

NOTE: You can change the value of a parameter if it is enclosed in square brackets. Navigation keys for a particular menu are shown on the bottom of the screen. Help for parameters are found in the Item Specific Help part of the screen. Read this carefully when making changes to parameter values.

This menu provides you the information of the system.

Information

PhoenixBIOS Setup Utility					
Information	Main	Advanced	Security	Boot	Exit

CPU Type:	AMD Athlon 64 DTR			
CPU Speed:	2000 MHz			
Floppy Drive:	1.44 MB 3 1/2"			
IDE1 Model Name:	IC25N060ATMR04-0-(PM)			
HDD1 Serial Number:	MRG326K3GLKX3H			
IDE2 Model Name:	PIONEER DVD-RW DVR-K12RA-(SM)			
HDD2 Serial Number:	None			
System BIOS Ver:	AS1500 V0.16			
VGA BIOS Ver:	BK-ATI VER008.001.001.031			
KBC Ver:	02.13.29			
Serial Number:	xxxxxxxxxxxxxxxxxxxxxx			22 Byte
Asset Tag Number:	N/A			32 Byte
Product Name:	Aspire 1500			16 Byte
Manufacturer Name:	Acer			16 Byte
UUID:	xxxxxxx-xxxx-xxxx-xxxx-xxxxxxxxxxxx			16 Byte

F1 Help	↑↓ Select Item	F5/F6 Change Values	F9 Setup Defaults
Esc Exit	←→ Select Menu	Enter Select ▶ Sub-Menu	F10 Save and Exit

Parameter	Description
Serial Number	This field displays the serial number of this unit.
UUID Number	UUID=32bytes

Main

The Main screen displays a summary of your computer hardware information, and also includes basic setup parameters. It allows the user to specify standard IBM PC AT system parameters.

PhoenixBIOS Setup Utility					
Information	Main	Advanced	Security	Boot	Exit
					Item Specific Help
System Time:	[18:48:04]				<Tab>, <Shift-Tab>, or <Enter> selects field.
System Date:	[11/26/2003]				
System Memory:	640 KB	Shows system memory size			
Extended Memory:	510 MB	Shows extended memory size			
VGA Memory:	64MB	VGA memory size			
Quiet Boot:	[Enabled]				
Power on display:	[Auto]				
LCD Auto Dim:	[Enabled]				
Wakeup from LAN	[Disabled]				
F12 Boot Menu	[Disabled]				
F1 Help	↑↓ Select Item	F5/F6 Change Values	F9 Setup Defaults		
Esc Exit	←→ Select Menu	Enter Select	▶ Sub-Menu	F10 Save and Exit	

NOTE: The screen above is for reference only. Actual values may differ.

The table below describes the parameters in this screen. Settings in **boldface** are the default and suggested parameter settings.

Parameter	Description	Format/Option
System Time	Sets the system time.	Format: HH:MM:SS (hour:minute:second) System Time
System Date	Sets the system date.	Format MM/DD/YYYY (month/day/year) System Date
System Memory	This field reports the memory size of the system. Memory size is fixed to 640MB	
Extended Memory	This field reports the memory size of the extended memory in the system. Extended Memory size=Total memory size-1MB	
Video Memory	Shows the VGA memory size. The default value is set to 32MB	Option: 32 /64MB
Quiet Boot	Determines if Customer Logo will be displayed or not; shows Summary Screen is disabled or enabled. Enabled: Customer Logo is displayed, and Summary Screen is disabled. Disabled: Customer Logo is not displayed, and Summary Screen is enabled.	Option: Enabled or Disabled
Power on display	Auto: During power process, the system will detect if any display device is connected on external video port. If any external display device is connected, the power on display will be in CRT (or projector) only mode. Otherwise it will be in LCD only mode. Both: Simultaneously enable both the integrated LCD screen and the system's external video port (for an external CRT or projector).	Option: Auto or Both
LCD Auto Dim	Determines if the system will automatically dim the LCD brightness in order to save power when AC is not present.	Option: Enabled or Disabled

NOTE: The sub-items under each device will not be shown if the device control is set to disable or auto. This is because the user is not allowed to control the settings in these cases.

Advanced

The Advanced menu screen contains parameters involving your hardware devices. It also provides advanced settings of the system.

PhoenixBIOS Setup Utility		
Information	Main	Advanced
Infrared Port(FIR):	[Enabled]	Item Specific Help
Base I/O address:	[2F8]	
Interrupt:	[378]	Configure Infrared Port using options:
DMA channel	[IRQ 3] [DMA 3]	
Parallel port:	[Enabled]	[Disable] No configuration
Mode:	[ECP]	[Enabled] User configuration
Base I/O address:	[378]	[Auto] BIOS or OS chooses configuration
Interrupt:	[IRQ 7]	(OS Controlled) Displayed when controlled by OS
DMA channel	[DMA1]	
Legacy USB Support:	[Enabled]	

F1 Help	↑ ↓ Select Item	F5/F6 Change Values	F9 Setup Defaults
Esc Exit	← → Select Menu	Enter Select ▶ Sub-Menu	F10 Save and Exit

The table below describes the parameters in the screen. Settings in **boldface** are the default and suggested parameter settings.

Parameter	Description	Options
Serial Port	Enables, disables or auto detects the serial port.	Enabled /Disabled/Auto
Parallel Port	Enables, disables or auto detects the parallel port.	Enabled /Disabled/Auto
Mode	Sets the operation mode of the parallel port.	ECP , EPP, Normal or Bi-directional
Base I/O address	Sets the I/O address of the parallel port. This parameter is enabled only if Mode is set to ECP or Bi-directional. This parameter is enabled only if Mode is set to ECP.	378h /278h/3BCh
Interrupt	Sets the interrupt request of the parallel port.	IRQ7 /IRQ5
DMA channel	Sets a DMA channel for the printer to operate in ECP mode. This parameter is enabled only if Mode is set to ECP.	DMA3 /DMA1

Parameter	Description	Options
Internal Touchpad	Determines whether or not to disable the internal pointing device as the PS/2 mouse is connected.	Both or Auto
Infrared Port (FIR)	Enables, disables or auto detects the infrared port.	Disabled/Enabled Disabled/Auto

Security

The Security screen contains parameters that help safeguard and protect your computer from unauthorized use.

PhoenixBIOS Setup Utility					
Information	Main	Advanced	Security	Boot	Exit
				Item Specific Help	
User Password is		Clear		Supervisor Password controls accesses of the whole setup utility. It can be used to boot up when Password on boot is enabled.	
Supervisor Password is		Clear			
Set User Password		[Enter]			
Set Supervisor Password		[Enter]			
Primary HardDisk Security		[Disabled]			
Password on Boot		[Disabled]			

F1 Help	↑ ↓ Select Item	F5/F6 Change Values	F9 Setup Defaults
Esc Exit	← → Select Menu	Enter Select ▶ Sub-Menu	F10 Save and Exit

The table below describes the parameters in this screen. Settings in **boldface** are the default and suggested parameter settings.

Parameter	Description	Option
User Password is	Shows the setting of the user password.	Clear or Set
Supervisor Password is	Shows the setting of the Supervisor password	Clear or Set
Primary Harddisk Security	This feature is available to user when Supervisor password is set. Password can be written on HDD only when Supervisor password or user password is set and password on HDD is set to enabled. Supervisor Password is written to HDD only when Supervisor password is being set. User password is written to HDD when both passwords are set. When both Supervisor and user password are present, both passwords can unlock the HDD.	Disabled or Enabled
Set User Password	Press Enter to set the user password. When set, this password protects the BIOS Setup Utility from unauthorized access.	
Set Supervisor Password	Press Enter to set the supervisor password. When set, this password protects the BIOS Setup Utility from unauthorized access.	
Password on Boot	Defines whether a password is required or not while the events defined in this group happened. The following sub-options are all requires the Supervisor password for changes and should be grayed out if the user password was used to enter setup.	Disabled or Enabled

NOTE: When you are prompted to enter a password, you have three tries before the system halts. Don't forget your password. If you forget your password, you may have to return your notebook computer to your dealer to reset it.

Setting a Password

Follow these steps as you set the user or the supervisor password:

1. Use the **↑** and **↓** keys to highlight the Set Supervisor Password parameter and press the **ENTER** key. The Set Supervisor Password box appears:

Set Supervisor Password

Enter New Password []

Confirm New Password []

2. Type a password in the "Enter New Password" field. The password length can not exceeds 8 alphanumeric characters (A-Z, a-z, 0-9, not case sensitive). Retype the password in the "Confirm New Password" field.

IMPORTANT: Be very careful when typing your password because the characters do not appear on the screen.

3. Press **ENTER**.
4. After setting the password, the computer sets the User Password parameter to "Set".
5. If desired, you can opt to enable the Password on boot parameter.
6. When you are done, press **F10** to save the changes and exit the BIOS Setup Utility.

Removing a Password

Follow these steps:

1. Use the **↑** and **↓** keys to highlight the Set Supervisor Password parameter and press the **ENTER** key. The Set Password box appears:

Set Supervisor Password		
Enter current password	[]
Enter New Password	[]
Confirm New Password	[]

2. Type the current password in the Enter Current Password field and press **ENTER**.
3. Press **ENTER** twice **without** typing anything in the Enter New Password and Confirm New Password fields. The computer then sets the Supervisor Password parameter to "Clear".
4. When you have changed the settings, press **F10** to save the changes and exit the BIOS Setup Utility.

Changing a Password

1. Use the **↑** and **↓** keys to highlight the Set Supervisor Password parameter and press the **ENTER** key. The Set Password box appears:

Set Supervisor Password		
Enter current password	[]
Enter New Password	[]
Confirm New Password	[]

2. Type the current password in the Enter Current Password field and press **ENTER**.
3. Type a password in the Enter New Password field. Retype the password in the Confirm New Password field.
4. Press **ENTER**. After setting the password, the computer sets the User Password parameter to "Set".
5. If desired, you can enable the Password on boot parameter.
6. When you are done, press **F10** to save the changes and exit the BIOS Setup Utility.

If the verification is OK, the screen will display as following.

Setup Notice		
Changes have been saved.		
[continue]		

The password setting is complete after the user presses .

If the current password entered does not match the actual current password, the screen will show you the Setup Warning.

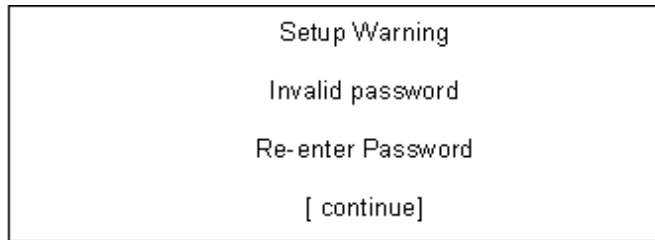

If the new password and confirm new password strings do not match, the screen will display the following message.

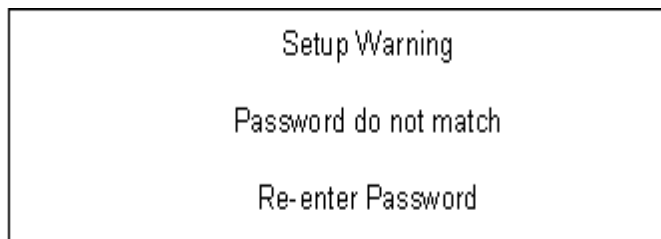

Boot

This menu allows the user to decide the order of boot devices to load the operating system. Bootable devices includes the distette drive in module bay, the onboard hard disk drive and the CD-ROM in module bay.

PhoenixBIOS Setup Utility					
Information	Main	Advanced	Security	Boot	Exit
CD-ROM Drive +Hard Drive +Removable Devices Network Boot				Item Specific Help	
				Keys used to view or configure devices: <Enter> expnads or collapses devices with a + or - <Ctrl+Enter> expands all <F6> and <F5 moves the device up or down.	
F1 Help	↑↓ Select Item	F5/F6 Change Values	F9 Setup Defaults		
Esc Exit	←→ Select Menu	Enter Select ▶ Sub-Menu	F10 Save and Exit		

Exit

The Exit screen contains parameters that help safeguard and protect your computer from unauthorized use.

PhoenixBIOS Setup Utility			
Information	Main	Advanced	Security
Boot	Exit		
Exit Saving Changes Exit Discarding Changes Load Setup Defaults Discard Changes Save Changes			Item Specific Help Exit System Setup and save your changes to CMOS.
F1 Help	↑↓ Select Item	F5/F6 Change Values	F9 Setup Defaults
Esc Exit	←→ Select Menu	Enter Select ▶ Sub-Menu	F10 Save and Exit

The table below describes the parameters in this screen.

Parameter	Description
Exit Saving Changes	Exit System Setup and save your changes to CMOS.
Exit Discarding Changes	Exit utility without saving setup data to CMOS.
Load Setup Default	Load default values for all SETUP item.
Discard Changes	Load previous values from CMOS for all SETUP items.
Save Changes	Save Setup Data to CMOS.

BIOS Flash Utility

The BIOS flash memory update is required for the following conditions:

- New versions of system programs
- New features or options
- Restore a BIOS when it becomes corrupted.

Use the Phlash utility to update the system BIOS flash ROM.

NOTE: If you do not have a crisis recovery diskette at hand, then you should create a **Crisis Recovery Diskette** before you use the Phlash utility.

NOTE: Do not install memory-related drivers (XMS, EMS, DPMS) when you use the Phlash.

NOTE: Please use the AC adaptor power supply when you run the Phlash utility. If the battery pack does not contain enough power to finish BIOS flash, you may not boot the system because the BIOS is not completely loaded.

Follow the steps below to run the Phlash.

1. Prepare a bootable diskette.
2. Copy the Phlash utilities to the bootable diskette.
3. Then boot the system from the bootable diskette. The Phlash utility has auto-execution function.

Machine Disassembly and Replacement

This chapter contains step-by-step procedures on how to disassemble the notebook computer for maintenance and troubleshooting.

To disassemble the computer, you need the following tools:

- Wrist grounding strap and conductive mat for preventing electrostatic discharge
- Flat-bladed screw driver
- Phillips screw driver
- Tweezers
- Plastic Flat-bladed screw driver
- Hexed Screw Driver

NOTE: The screws for the different components vary in size. During the disassembly process, group the screws with the corresponding components to avoid mismatch when putting back the components.

General Information

Before You Begin

Before proceeding with the disassembly procedure, make sure that you do the following:

1. Turn off the power to the system and all peripherals.
2. Unplug the AC adapter and all power and signal cables from the system

NOTE: Aspire 1500 series product uses mylar or tape to fasten the FFC/FPC/connectors/cable, you may need to tear the tape or mylar before you disconnect different FFC/FPC/connectors.

Disassembly Procedure Flowchart

The flowchart on the succeeding page gives you a graphic representation on the entire disassembly sequence and instructs you on the components that need to be removed during servicing. For example, if you want to remove the main board, you must first remove the keyboard, then disassemble the inside assembly frame in that order.

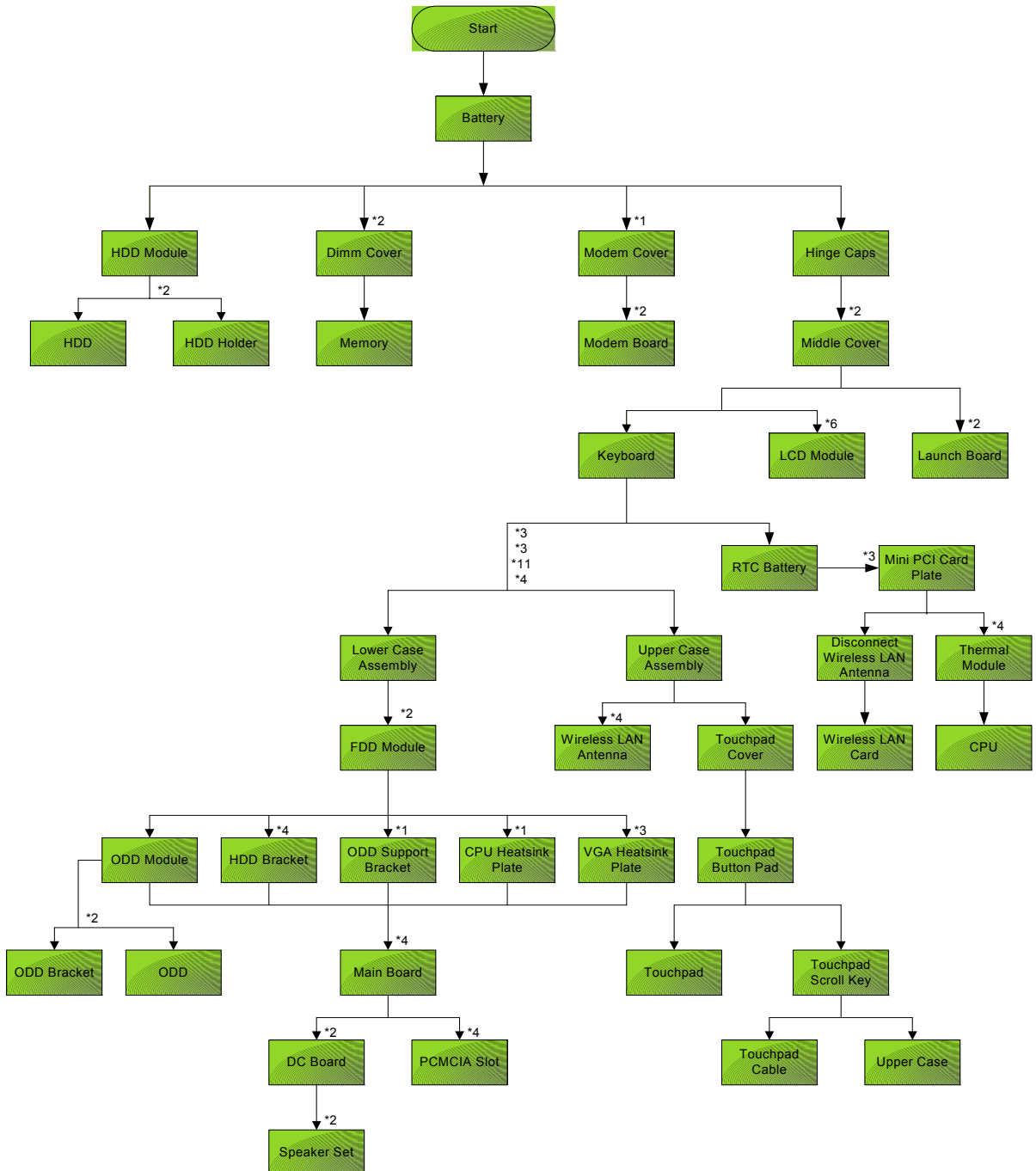

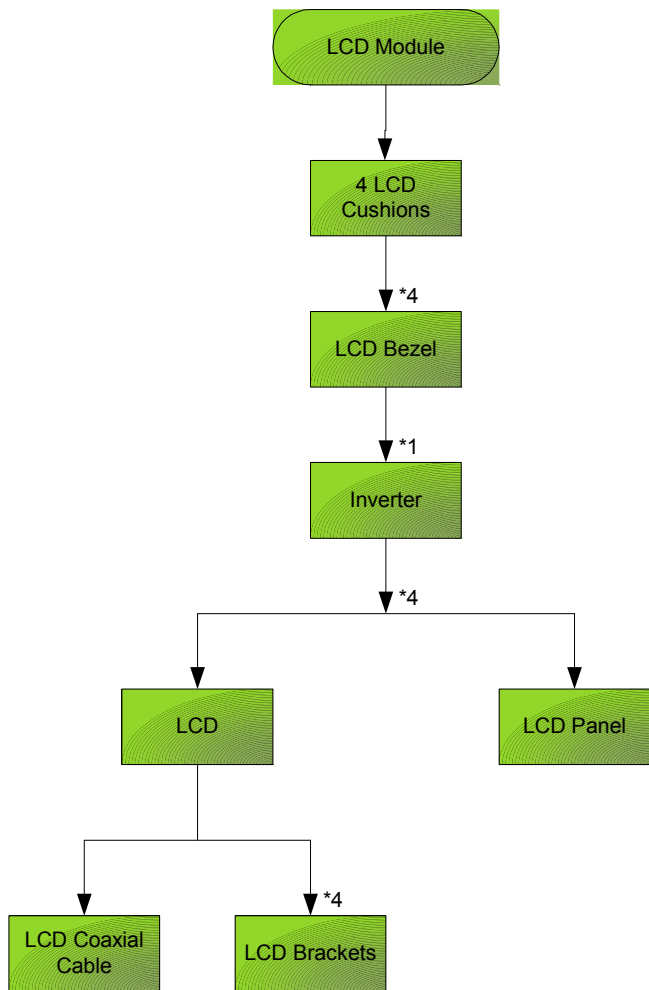

Screw List

Item	Description
A	SCRW MAC FLAT M2.5*L4 NI NYLOK
B	SCREW M2.0*L10 NYLOK
C	SCREW M2*3 NYLON 1JMCPC-420325
D	SCREW M2.5X6
E	SCREW M3x4(86.9A524.4R0)
F	SCREW M2X2.0
G	SCREW WAFER NYLOK NI 2ML3
H	SCRW M2*4 WAFER NI
I	SCRW M2.5*3 WAFER NI
J	SCREW M2.5*4L NI
K	SCW HEX NYL I#R-40/O#4-40 L5.5

Removing the Battery

1. To remove the battery, push the battery release latch.
2. Then slide the battery out from the machine.



Removing the Memory Module

1. See “Removing the Battery” on page 46..
2. To remove the memory module from the machine, first remove the two screws holding the dimm cover.



3. Remove the dimm cover.



4. Pop up the memory.
5. Then remove the memory.



Removing the Modem Board

1. See “Removing the Battery” on page 46.
2. To remove the modem board, first remove the screw from the modem cover.



3. Remove the modem cover from the machine.



4. Remove two screws from the modem board as shown. Please remove the screws according to the number on the picture indicate.
5. Then remove the modem board from the main unit carefully by using a plastic bladed screw driver.



6. Disconnect the modem cable from the modem board, then remove the modem board.



Removing the Hard Disk Drive Module

1. See “Removing the Battery” on page 46..
2. To remove the hard disk drive, pull the hard disk drive carefully.



3. Then take the hard disk drive out of the main unit.

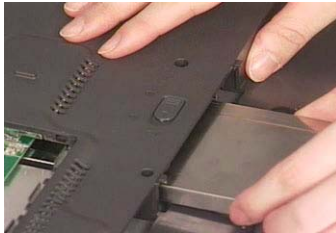

Disassembling the Hard Disk Drive Module

1. See “Removing the Battery” on page 46..
2. See “Removing the Hard Disk Drive Module” on page 49..
3. Remove the two screws that fasten the HDD holder.



4. Detach the hard disk drive from the HDD holder.



Removing the LCD Module

Removing the Middle Cover

1. See “Removing the Battery” on page 46..
2. To remove the middle cover, first use a plastic flat screwdriver to remove the right hinge cap.
3. Remove the screw that secures the middle cover.



4. Remove the left hinge cap.
5. Then remove the screw holding the middle cover on the other side.



6. Detach the middle cover from the machine.



7. Disconnect the launch board cable then remove the middle cover off the main unit.



Removing the Launch Board

1. See “Removing the Battery” on page 46..

2. See “Removing the Middle Cover” on page 50..
3. Remove the two screws and then detach the launch board from the middle cover.



Removing the LCD Module

1. See “Removing the Battery” on page 46..
2. See “Removing the Middle Cover” on page 50..
3. See “Removing the Launch Board” on page 50..
4. Remove the screw that fastens the LCD coaxial cable and disconnect the cable. Then disconnect the LCD inverter cable.



5. Remove the four screws holding the LCD hinge; two on the right and two on the left. Remove the four screws holding the LCD hinge; two on the right and two on the left.



6. Remove the two screws on the bottom; one on the right and the other on the left.



7. Then you can remove the entire LCD module from the main unit.

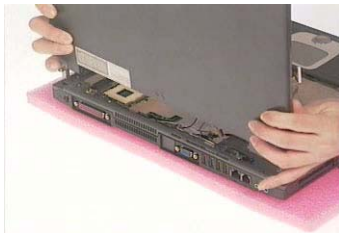

Disassembling the LCD Module

Removing the LCD Bezel

1. See “Removing the Battery” on page 46..
2. See “Removing the Middle Cover” on page 50..
3. See “Removing the Launch Board” on page 50..
4. See “Removing the LCD Module” on page 51..
5. Use plastic tweezers to remove the four screw pads, and then remove the four screws that fasten the LCD bezel.

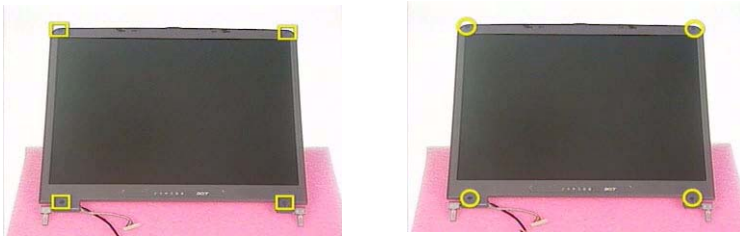

6. Snap off the bezel carefully, and then remove the LCD bezel from the LCD module.



Removing the Inverter Board (15" LCD)

1. See “Removing the Battery” on page 46..
2. See “Removing the Middle Cover” on page 50..
3. See “Removing the Launch Board” on page 50..
4. See “Removing the LCD Module” on page 51..
5. See “Removing the LCD Bezel” on page 53..
6. To remove the inverter board, first remove one screw from the inverter board.

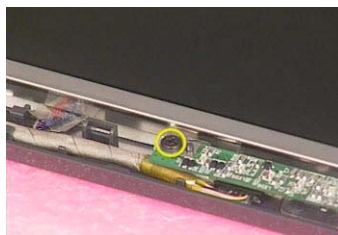

7. Disconnect the LCD power cable then disconnect the inverter cable from the inverter board.



NOTE: Please arrange the LCD inverter cable well to the LCD panel as the picture below shows when you reassemble the LCD module.



Removing the 15" TFT LCD

1. See "Removing the Battery" on page 46..
2. See "Removing the Middle Cover" on page 50..
3. See "Removing the Launch Board" on page 50..
4. See "Removing the LCD Module" on page 51..
5. see "Removing the LCD Bezel" on page 53.
6. See "Removing the Inverter Board (15" LCD)" on page 53..
7. To remove the LCD, first remove the four screws that secure the LCD hinges.



8. Then take the LCD out of the LCD panel.



Removing the LCD Brackets

1. See “Removing the Battery” on page 46..
2. See “Removing the Middle Cover” on page 50..
3. See “Removing the Launch Board” on page 50..
4. See “Removing the LCD Module” on page 51..
5. See “Removing the LCD Bezel” on page 53..
6. See “Removing the Inverter Board (15” LCD)” on page 53..
7. See “Removing the 15” TFT LCD” on page 54..
8. Remove the four screws holding the right LCD bracket. Then remove the right bracket.

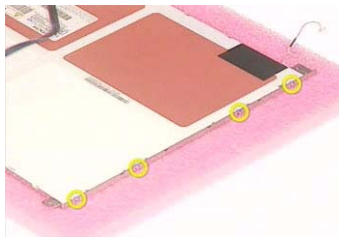

9. Remove the four screws holding the left LCD bracket. Then remove the left bracket..

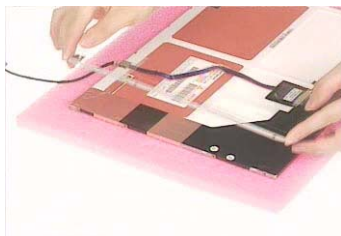
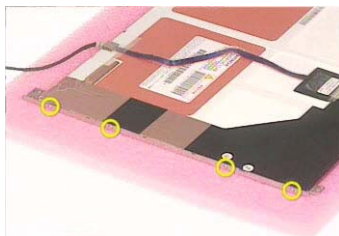

Removing the LCD Coaxial Cable

1. See “Removing the Battery” on page 46..
2. See “Removing the Middle Cover” on page 50..
3. See “Removing the Launch Board” on page 50..
4. See “Removing the LCD Module” on page 51..
5. See “Removing the LCD Bezel” on page 53..
6. See “Removing the Inverter Board (15” LCD)” on page 53..
7. See “Removing the 15” TFT LCD” on page 54..
8. Tear off the mylar fastening the LCD coaxial cable, then disconnect the coaxial cable.



Removing the LCD Hinges

1. See “Removing the Battery” on page 46..
2. See “Removing the Middle Cover” on page 50..
3. See “Removing the Launch Board” on page 50..
4. See “Removing the LCD Module” on page 51..
5. See “Removing the LCD Bezel” on page 53..
6. See “Removing the Inverter Board (15” LCD)” on page 53..
7. See “Removing the 15” TFT LCD” on page 54..
8. Remove the screw holding the right hinge, then remove the right hinge.

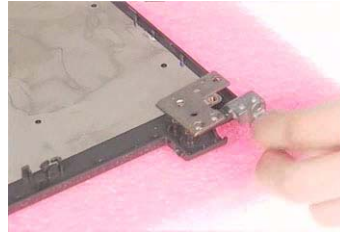

9. Remove the screw holding the left hinge, then remove the left hinge.



Disassembling the Main Unit

Removing the Keyboard

1. See “Removing the Battery” on page 46..
2. See “Removing the Middle Cover” on page 50..
3. To remove the keyboard, first pull out and upward to expose the keyboard.



4. Use a plastic tweezers or a plastic flat screwdriver to disconnect the keyboard cable from the main board carefully, then remove the keyboard from the main board.

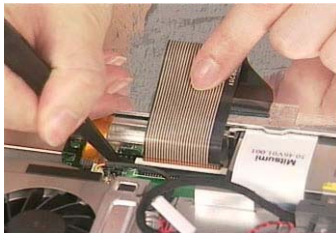

Removing the RTC Battery

1. See “Removing the Battery” on page 46..
2. See “Removing the Middle Cover” on page 50..
3. See “Removing the LCD Module” on page 51..
4. Disconnect the RTC battery cable then remove it.



Removing the MimiPCI Card Plate

1. See “Removing the Battery” on page 46..
2. See “Removing the Middle Cover” on page 50..
3. See “Removing the LCD Module” on page 51..
4. See “Removing the RTC Battery” on page 57..

5. Remove the three screws holding the mini PCI card plate and remove the mini PCI card plate.

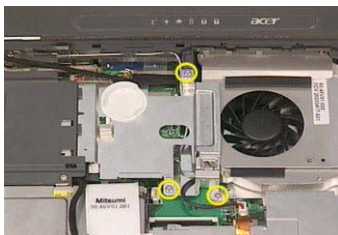

Removing the Thermal Module

1. See “Removing the Battery” on page 46..
2. See “Removing the Middle Cover” on page 50..
3. See “Removing the LCD Module” on page 51..
4. See “Removing the RTC Battery” on page 57..
5. See “Removing the MimiPCI Card Plate” on page 57..
6. Disconnect the fan cable then remove the four screws fastening the thermal module.

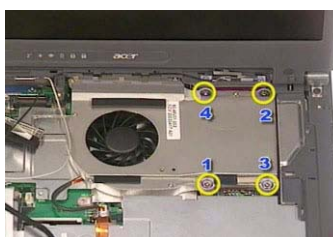
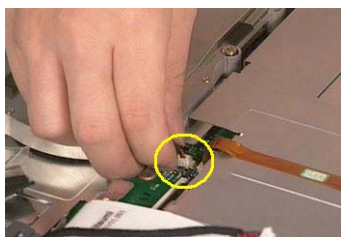

7. Then remove the thermal module.

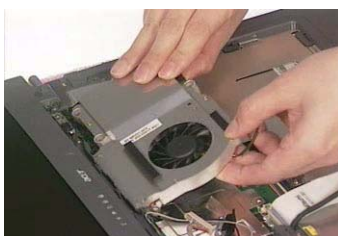

Removing the Processor

1. See “Removing the Battery” on page 46..
2. See “Removing the Middle Cover” on page 50..
3. See “Removing the Keyboard” on page 57..
4. See “Removing the RTC Battery” on page 57..
5. See “Removing the MimiPCI Card Plate” on page 57..
6. See “Removing the Thermal Module” on page 58..
7. Lift up the CPU socket lever. Then remove the CPU. Remember to press down the lever as the video shows after you remove the CPU.

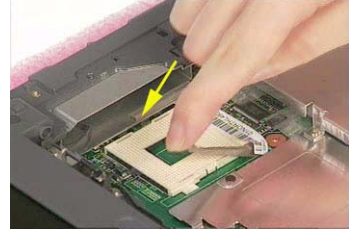
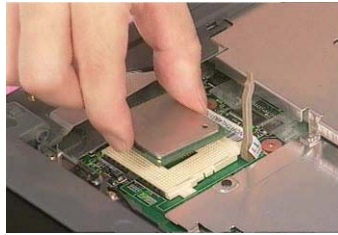
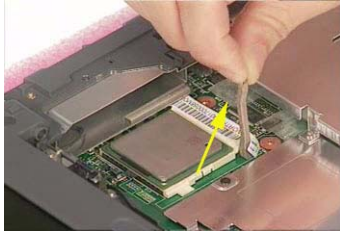

Installing the Processor

1. See “Removing the Battery” on page 46..
2. See “Removing the Middle Cover” on page 50..
3. See “Removing the Keyboard” on page 57..
4. See “Removing the RTC Battery” on page 57..
5. See “Removing the MimiPCI Card Plate” on page 57..
6. See “Removing the Thermal Module” on page 58..
7. Lift up the CPU lever, then place the CPU back to the CPU socket. Please remember to press the CPU lever after you put the CPU back to the socket.

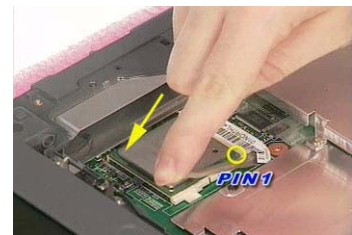
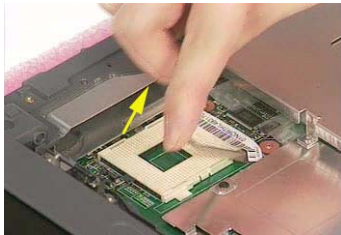

Removing the Upper Case Assembly

1. See “Removing the Keyboard” on page 57..
2. Disconnect the touchpad cable.

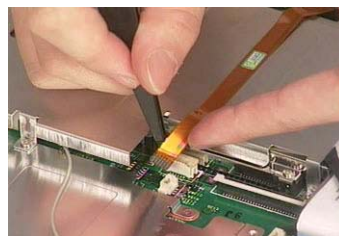
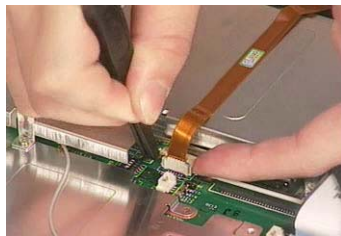

3. Remove the 6 screws that secure the upper case to the lower case. Then turn over the main unit and remove the 15 screws holding the lower case to the upper case.

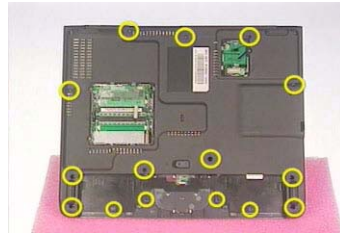
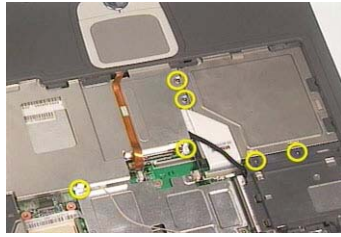

4. Then take the upper case assembly off the main unit.



Removing the Touchpad Board

1. See “Removing the Battery” on page 46..
2. See “Removing the Middle Cover” on page 50..
3. See “Removing the Keyboard” on page 57..
4. See “Removing the Upper Case Assembly” on page 59..
5. To detach the touch pad board, first disconnect the touch pad cable from the touch pad board with a plastic tweezers. Then release the touchpad cover lock on the back as the picture shows.

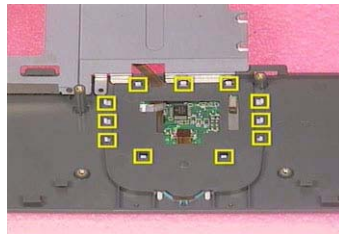

6. Remove the touchpad cover, then remove the touchpad button pad. Finally remove the touchpad board from the upper case.



Removing the Touchpad Cable

1. See “Removing the Battery” on page 46..

2. See “Removing the Middle Cover” on page 50..
3. See “Removing the LCD Module” on page 51..
4. See “Removing the Keyboard” on page 57..
5. See “Removing the Upper Case Assembly” on page 59..
6. See “Removing the Touchpad Board” on page 60..
7. Remove the touchpad scroll key then remove the touchpad cable.

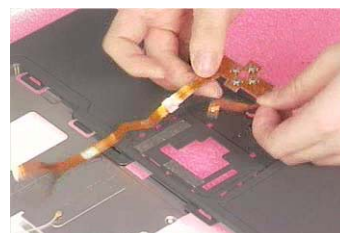

Removing the Floppy Disk Drive Module

1. See “Removing the Middle Cover” on page 50..
2. See “Removing the LCD Module” on page 51..
3. See “Removing the Keyboard” on page 57..
4. See “Removing the Upper Case Assembly” on page 59..
5. Disconnect the FDD cable from the main board.

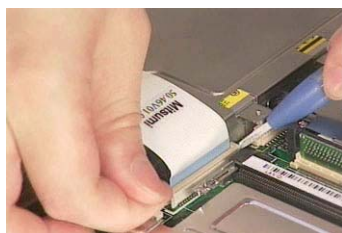

6. Remove the two screws hastening the FDD module. Detach the FDD module from the lower case.

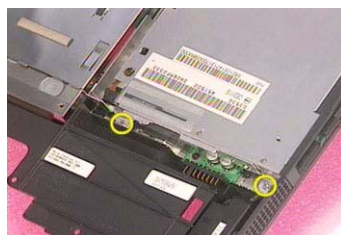

Disassembling the Floppy Disk Drive Module

1. Disconnect the FDD cable.
2. Remove the two screws that fasten the FDD bracket on one side.

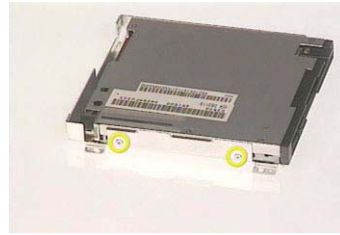
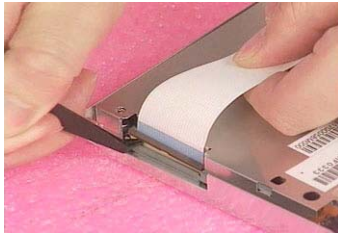

3. Remove another two screws holding the FDD bracket on the other side. Then take the FDD off the FDD bracket.

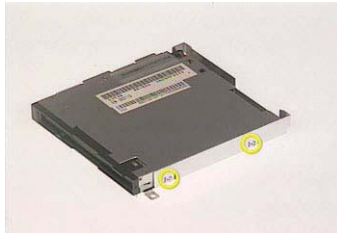

Removing the VGA Heatsink Plate

1. See “Removing the Battery” on page 46..
2. See “Removing the Middle Cover” on page 50..
3. See “Removing the Keyboard” on page 57..
4. See “Removing the Floppy Disk Drive Module” on page 61..
5. Remove the three screws that secure the VGA heatsink plate then remove the plate.

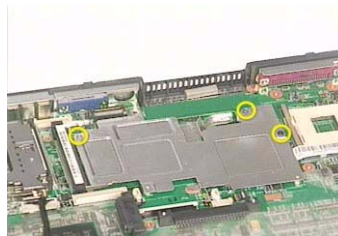

Removing the CPU Heatsink Plate

1. See “Removing the Battery” on page 46..
2. See “Removing the Middle Cover” on page 50..
3. See “Removing the Keyboard” on page 57..
4. See “Removing the Floppy Disk Drive Module” on page 61..
5. Remove the screw that fastens the CPU heatsink plate then remove it.

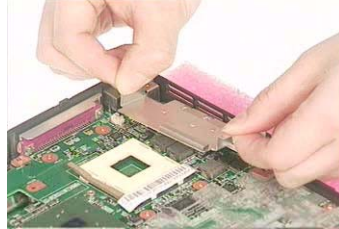

Removing the ODD Module(1)

1. See “Removing the Battery” on page 46.
2. Remove the screw that fastens the ODD bracket on the bottom. Push the ODD module at the point the red arrow indicates hard. Then remove the ODD module from the lower case.



NOTE: If you need to replace the ODD module only, you can remove the ODD module as the steps above.

Removing the ODD Module(2)

1. See “Removing the Battery” on page 46.
2. See “Removing the Middle Cover” on page 50.
3. See “Removing the Keyboard” on page 57.
4. See “Removing the Floppy Disk Drive Module” on page 61.
5. Push the ODD module outwards then take the ODD out of the support bracket. Remove the screw that fastens the ODD support bracket then remove it.

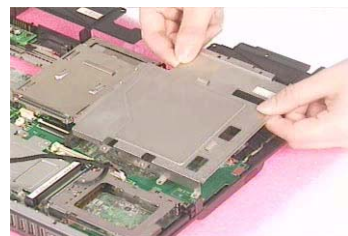
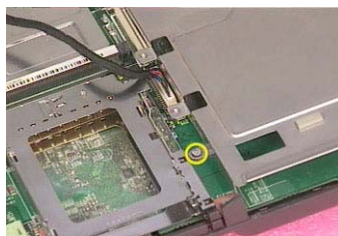

Removing the HDD Bracket

1. See “Removing the Battery” on page 46.
2. See “Removing the Middle Cover” on page 50.
3. See “Removing the Keyboard” on page 57.
4. See “Removing the Floppy Disk Drive Module” on page 61.
5. Remove the four screws holding the HDD bracket, then remove the HDD bracket.

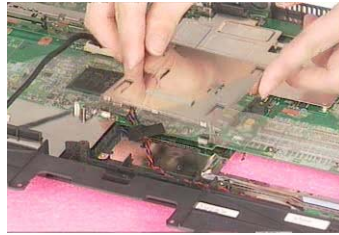
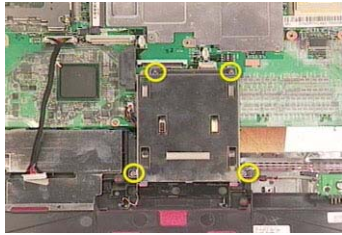

Removing the Main Board

1. See “Removing the Battery” on page 46.
2. See “Removing the Middle Cover” on page 50.
3. See “Removing the Keyboard” on page 57.
4. See “Removing the Floppy Disk Drive Module” on page 61.
5. See “Removing the VGA Heatsink Plate” on page 62.
6. See “Removing the CPU Heatsink Plate” on page 62.
7. See “Removing the ODD Module(1)” on page 63.
8. See “Removing the HDD Bracket” on page 63.
9. Disconnect the launch board cable. Tear off the tape that fastens the speaker set cable. Then disconnect the speaker set cable.

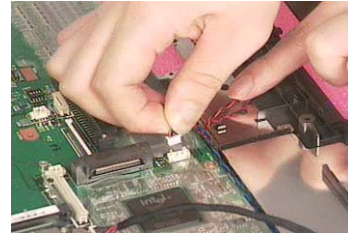
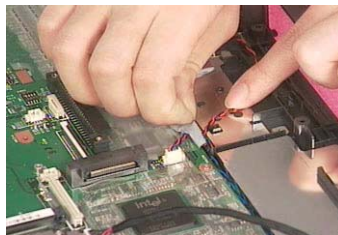
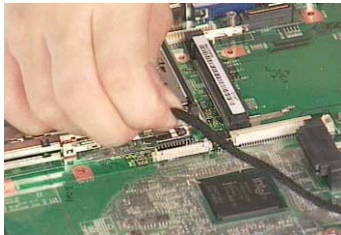

10. Remove the two screws holding the main board as the picture shows. Remove another two screws that fasten the main board. Then detach the main board from the lower case carefully.

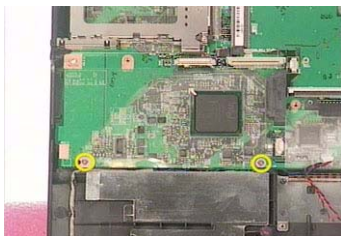

Removing the DC Board

1. See “Removing the Battery” on page 46.
2. See “Removing the Middle Cover” on page 50.
3. See “Removing the Keyboard” on page 57.
4. See “Removing the Floppy Disk Drive Module” on page 61.
5. See “Removing the VGA Heatsink Plate” on page 62.

6. See “Removing the CPU Heatsink Plate” on page 62.
7. See “Removing the ODD Module(1)” on page 63.
8. See “Removing the HDD Bracket” on page 63.
9. See “Removing the Main Board” on page 64.
10. Remove the two screws that fasten the DC board. Then detach the DC board from the lower case.

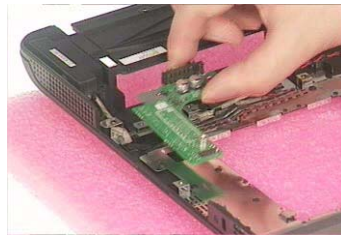
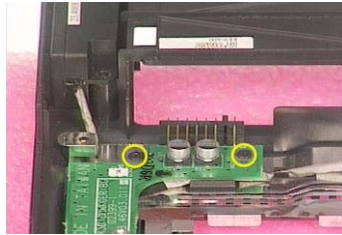

Removing the I/O Port Bracket

1. See “Removing the Battery” on page 46.
2. See “Removing the Middle Cover” on page 50.
3. See “Removing the Keyboard” on page 57.
4. See “Removing the Floppy Disk Drive Module” on page 61.
5. See “Removing the VGA Heatsink Plate” on page 62.
6. See “Removing the CPU Heatsink Plate” on page 62.
7. See “Removing the ODD Module(1)” on page 63.
8. See “Removing the HDD Bracket” on page 63.
9. See “Removing the Main Board” on page 64.
10. Remove the four hex screws to detach the I/O port bracket from the main board.



Removing the PCMCIA Slot

1. See “Removing the Battery” on page 46.
2. See “Removing the Middle Cover” on page 50.
3. See “Removing the Keyboard” on page 57.
4. See “Removing the Floppy Disk Drive Module” on page 61.
5. See “Removing the VGA Heatsink Plate” on page 62.
6. See “Removing the CPU Heatsink Plate” on page 62.
7. See “Removing the ODD Module(1)” on page 63.
8. See “Removing the HDD Bracket” on page 63.

-
9. See “Removing the Main Board” on page 64.
 10. Remove the four screws that secure the PCMCIA slot, then remove the PCMCIA slot from the lower case.

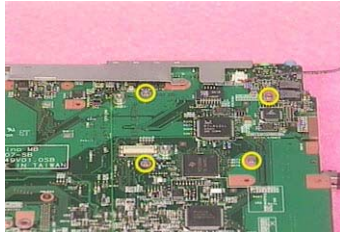

Removing the Speaker Set

1. See “Removing the Battery” on page 46.
2. See “Removing the Middle Cover” on page 50.
3. See “Removing the Keyboard” on page 57.
4. See “Removing the Floppy Disk Drive Module” on page 61.
5. See “Removing the VGA Heatsink Plate” on page 62.
6. See “Removing the CPU Heatsink Plate” on page 62.
7. See “Removing the ODD Module(1)” on page 63.
8. See “Removing the HDD Bracket” on page 63.
9. See “Removing the Main Board” on page 64.
10. See “Removing the DC Board” on page 64.
11. Tear off the tape fastening the speaker set cable. Then remove the four screws that secure the speaker set. Remove the speaker set from the lower case.

System Upgrade Procedure

Base Unit to Wireless Unit

1. See “Removing the Middle Cover” on page 50.
2. See “Removing the Keyboard” on page 57.
3. See “Removing the RTC Battery” on page 57.
4. See “Removing the MimiPCI Card Plate” on page 57.
5. Secure the wireless LAN card antenna by four screws. Insert the wireless LAN card to the socket then connect the wireless LAN card antenna to the wireless LAN card.

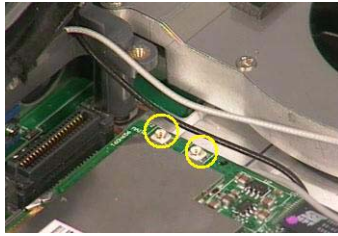

Assembling the Main Unit

Installing the Speaker Set

1. Attach the speaker set to the lower case. Secure the speaker set to the lower case with the four screws. Then stick the tape fastening the speaker set cable.

Installing the DC Board

1. See “Installing the Speaker Set” on page 68.
2. Attach the DC board to the lower case. Then secure the DC board to the lower case with two screws.

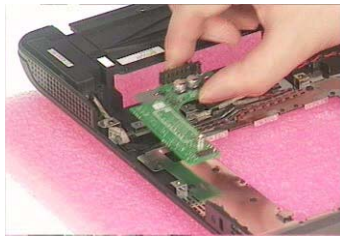

Installing the PCMCIA Slot

1. See “Installing the Speaker Set” on page 68.
2. See “Installing the DC Board” on page 68.
3. Attach the PCMCIA slot to the main board, and then fasten the PCMCIA slot to the main board with four screws

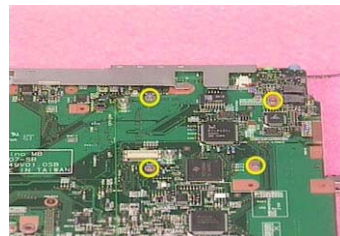
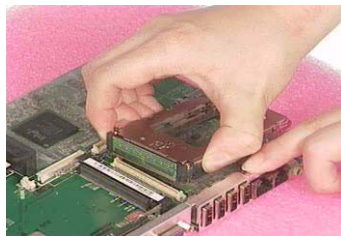

Installing the Main Board

1. See “Installing the Speaker Set” on page 68.
2. See “Installing the DC Board” on page 68.
3. See “Installing the PCMCIA Slot” on page 68.
4. Put the mainboard to the lower case. Secure the main board with the two screws as the picture shows. Fasten the main board to the lower case with another two screws.

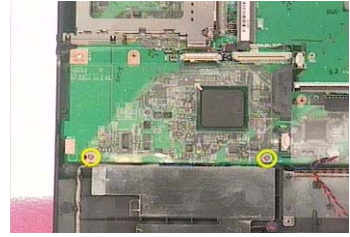
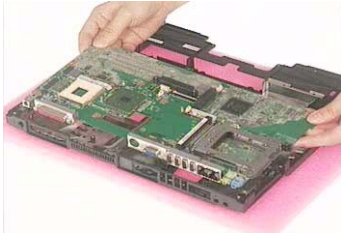

5. Connect the speaker set cable to the main board. Then stick the tape that fastens the speaker set cable. Connect the launch board cable to the main board.

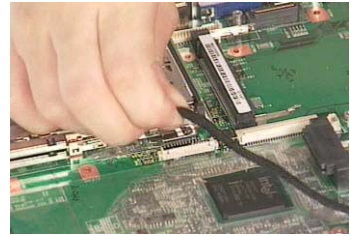
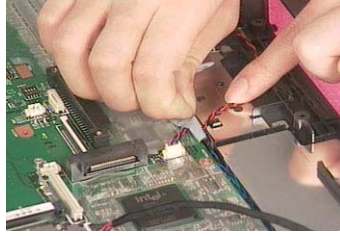
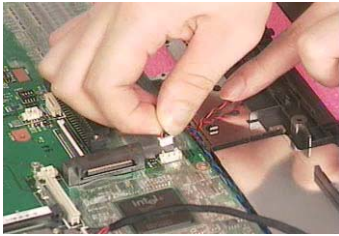

Installing the HDD Bracket

1. See "Installing the Speaker Set" on page 68.
2. See "Installing the DC Board" on page 68.
3. See "Installing the PCMCIA Slot" on page 68.
4. See "Installing the Main Board" on page 68.
5. Attach the HDD bracket. Then secure the HDD bracket with the four screws.

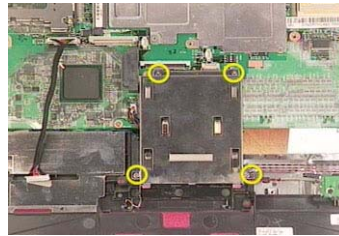
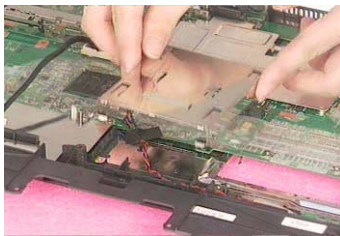

Installing the ODD Module

1. See "Installing the Speaker Set" on page 68.
2. See "Installing the DC Board" on page 68.
3. See "Installing the PCMCIA Slot" on page 68.
4. See "Installing the Main Board" on page 68.
5. See "Installing the HDD Bracket" on page 69.
6. Put the ODD support bracket to the lower case assembly, and then fasten the ODD support bracket with the one screw. Place the ODD back in the ODD support bracket, and then push the ODD to the original position.



Installing the CPU Heatsink Plate

1. See “Installing the Speaker Set” on page 68.
2. See “Installing the DC Board” on page 68.
3. See “Installing the PCMCIA Slot” on page 68.
4. See “Installing the Main Board” on page 68.
5. Place the CPU heatsink plate to the main board. Then secure the CPU heatsink plate with one screws.

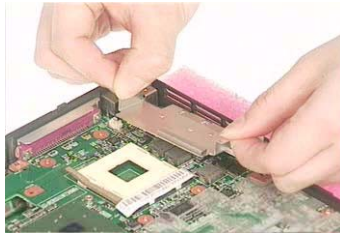

Installing the VGA Heatsink Plate

1. See “Installing the Speaker Set” on page 68.
2. See “Installing the DC Board” on page 68.
3. See “Installing the PCMCIA Slot” on page 68.
4. See “Installing the Main Board” on page 68.
5. Place the VGA heatsink plate to the main board. Then fasten the VGA heatsink plate with three screws.

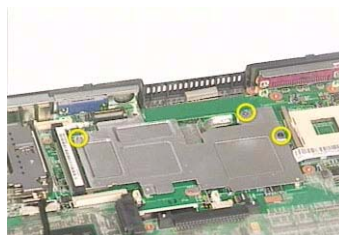

Installing the Floppy Disk Drive Module

1. See “Installing the Speaker Set” on page 68.
2. See “Installing the DC Board” on page 68.
3. See “Installing the PCMCIA Slot” on page 68.
4. See “Installing the Main Board” on page 68.
5. See “Installing the HDD Bracket” on page 69.
6. See “Installing the CPU Heatsink Plate” on page 70.
7. Put the FDD module to the main board. Secure the FDD module with two screws.

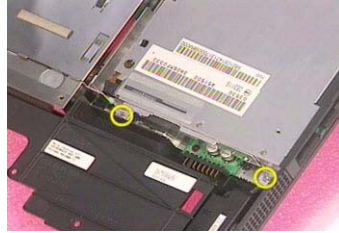

8. Connect the FDD cable to the main board.

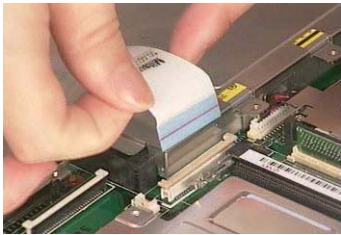

Installing the Touchpad Cable

1. Attach the touchpad cable to the upper case, and then pull out the cable.
2. Place the touchpad scroll key to the upper case.

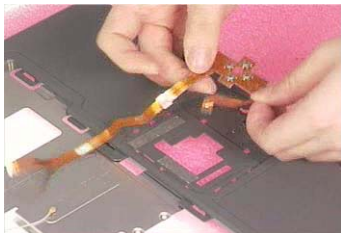

Installing the Touchpad Board

1. See “Installing the Touchpad Cable” on page 71.
2. Put the touchpad board and the touchpad button pad to the upper case. Then attach the touchpad cover to the upper case as the picture shows.



3. Connect the touch pad cable to the touchpad board with a plastic tweezers.



Installing the Upper Case Assembly

1. See "Installing the Speaker Set" on page 68.
2. See "Installing the DC Board" on page 68.
3. See "Installing the PCMCIA Slot" on page 68.
4. See "Installing the Main Board" on page 68.
5. See "Installing the HDD Bracket" on page 69.
6. See "Installing the ODD Module" on page 69.
7. See "Installing the CPU Heatsink Plate" on page 70.
8. See "Installing the VGA Heatsink Plate" on page 70.
9. See "Installing the Floppy Disk Drive Module" on page 71.
10. See "Installing the Touchpad Cable" on page 71.
11. See "Installing the Touchpad Board" on page 71.
12. Attach the upper case assembly to the lower case assembly.



13. Fasten the 15 screws on the bottom. Then secure the 6 screws as the picture shows.

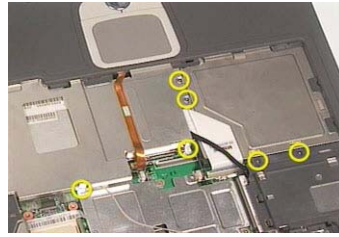
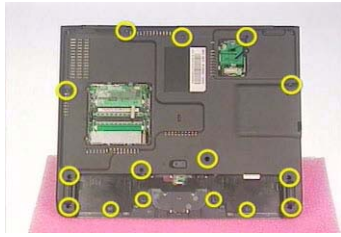

14. Connect the touchpad cable to the main board.

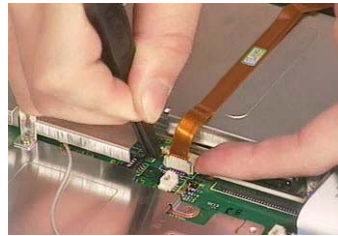
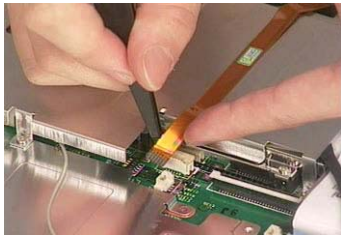

Installing the Processor

1. Lift up the CPU lever, then place the CPU back to the CPU socket carefully. Please remember to press the CPU lever after you put the CPU back to the socket.

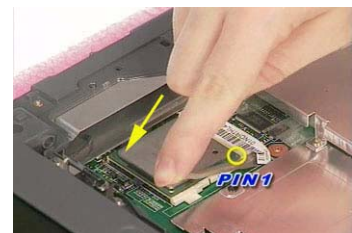
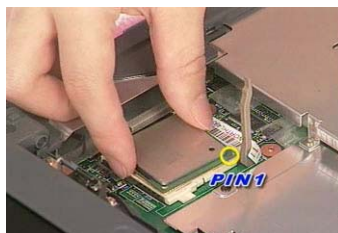
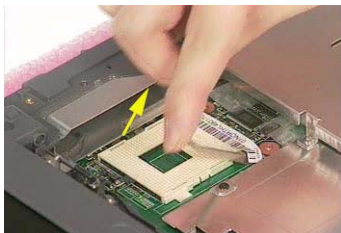

Installing the Thermal Module

1. See "Installing the Speaker Set" on page 68.
2. See "Installing the DC Board" on page 68.
3. See "Installing the PCMCIA Slot" on page 68.
4. See "Installing the Main Board" on page 68.
5. See "Installing the HDD Bracket" on page 69.
6. See "Installing the ODD Module" on page 69.
7. See "Installing the CPU Heatsink Plate" on page 70.
8. See "Installing the VGA Heatsink Plate" on page 70.
9. See "Installing the Floppy Disk Drive Module" on page 71.
10. See "Installing the Touchpad Cable" on page 71.
11. See "Installing the Touchpad Board" on page 71.
12. See "Installing the Upper Case Assembly" on page 72.

13. See “Installing the Processor” on page 73.
14. Place the thermal module to the main unit.



15. Secure the thermal module with the four screws. Then connect the thermal module cable to the main board.

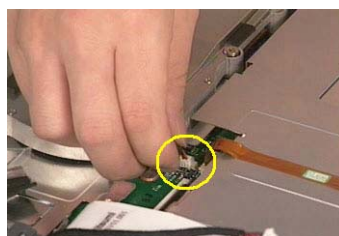
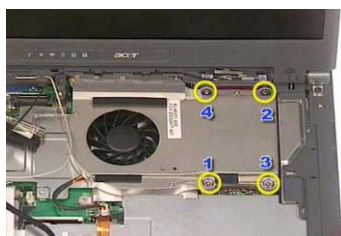

Installing the MimiPCI Card Plate

1. See “Installing the Speaker Set” on page 68.
2. See “Installing the DC Board” on page 68.
3. See “Installing the PCMCIA Slot” on page 68.
4. See “Installing the Main Board” on page 68.
5. See “Installing the HDD Bracket” on page 69.
6. See “Installing the ODD Module” on page 69.
7. See “Installing the CPU Heatsink Plate” on page 70.
8. See “Installing the VGA Heatsink Plate” on page 70.
9. See “Installing the Floppy Disk Drive Module” on page 71.
10. See “Installing the Touchpad Cable” on page 71.
11. See “Installing the Touchpad Board” on page 71.
12. See “Installing the Upper Case Assembly” on page 72.
13. See “Installing the Processor” on page 73.
14. See “Installing the Thermal Module” on page 73.
15. Place the mini PCI card plate to the main unit. Secure the mini PCI card plate with the three screws as the picture shows.

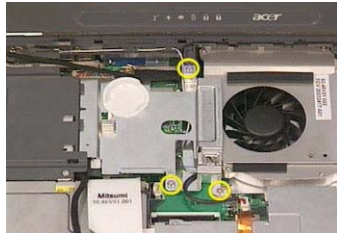

Installing the RTC Battery

1. See “Installing the Speaker Set” on page 68.
2. See “Installing the DC Board” on page 68.
3. See “Installing the PCMCIA Slot” on page 68.
4. See “Installing the Main Board” on page 68.
5. See “Installing the HDD Bracket” on page 69.
6. See “Installing the ODD Module” on page 69.
7. See “Installing the CPU Heatsink Plate” on page 70.
8. See “Installing the VGA Heatsink Plate” on page 70.
9. See “Installing the Floppy Disk Drive Module” on page 71.
10. See “Installing the Touchpad Cable” on page 71.
11. See “Installing the Touchpad Board” on page 71.
12. See “Installing the Upper Case Assembly” on page 72.
13. See “Installing the Processor” on page 73.
14. See “Installing the Thermal Module” on page 73.
15. See “Installing the MimiPCI Card Plate” on page 74.
16. Place the RTC battery to the RTC battery holder. Connect the RTC battery cable to the main board.



Installing the Keyboard

1. See “Installing the Speaker Set” on page 68.
2. See “Installing the DC Board” on page 68.
3. See “Installing the PCMCIA Slot” on page 68.
4. See “Installing the Main Board” on page 68.
5. See “Installing the HDD Bracket” on page 69.
6. See “Installing the ODD Module” on page 69.

-
7. See “Installing the CPU Heatsink Plate” on page 70.
 8. See “Installing the VGA Heatsink Plate” on page 70.
 9. See “Installing the Floppy Disk Drive Module” on page 71.
 10. See “Installing the Touchpad Cable” on page 71.
 11. See “Installing the Touchpad Board” on page 71.
 12. See “Installing the Upper Case Assembly” on page 72.
 13. See “Installing the Processor” on page 73.
 14. See “Installing the Thermal Module” on page 73.
 15. See “Installing the MimiPCI Card Plate” on page 74.
 16. See “Installing the RTC Battery” on page 75.
 17. Attach the keyboard cable to its connector on the main board. Connect the keyboard cable.



18. Turn over the keyboard and attach the keyboard to the main unit.



Assembling the LCD Module

Installing the LCD Hinges

1. Place the left hinge to the LCD panel. Secure the left hinge with one screw.



2. Place the right hinge to the LCD panel. Fasten the right hinge with one screw.

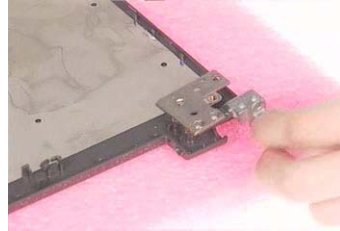

Installing the LCD Coaxial Cable

1. See “Installing the LCD Hinges” on page 77.
2. Connect the LCD coaxial cable and fasten with mylar. Fasten the LCD coaxial cable with mylar.



Installing the LCD Brackets

1. See “Installing the LCD Hinges” on page 77.
2. See “Installing the LCD Coaxial Cable” on page 77.
3. Attach the left bracket to the LCD. Then secure the left LCD bracket with four screws.

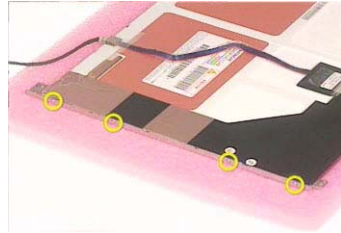
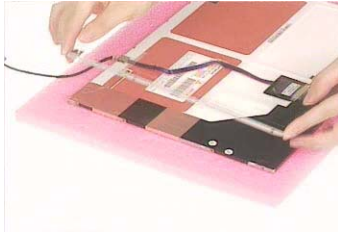

4. Attach the right bracket to the LCD. Fasten the right LCD bracket with four screws.

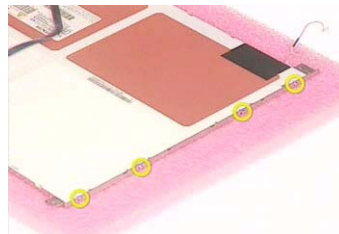

Installing the 15" TFT LCD

1. See "Installing the LCD Hinges" on page 77.
2. See "Installing the LCD Coaxial Cable" on page 77.
3. See "Installing the LCD Brackets" on page 77.
4. Place the LCD to the LCD panel.



5. Secure the left hinge with two screws. Fasten the right hinge with two screws.



Installing the Inverter Board (15" LCD)

1. See "Installing the LCD Hinges" on page 77.
2. See "Installing the LCD Coaxial Cable" on page 77.

3. See “Installing the LCD Brackets” on page 77.
4. See “Installing the 15” TFT LCD” on page 78.
5. Connect the inverter cable to the inverter board. Connect the inverter board to the LCD.



NOTE: Please arrange the LCD inverter cable well to the LCD panel as the picture below shows when you reassemble the LCD module.



6. Secure the inverter board with one screw.

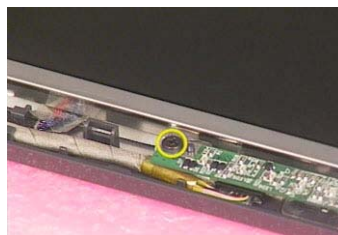

Installing the LCD Bezel

1. See “Installing the LCD Hinges” on page 77.
2. See “Installing the LCD Coaxial Cable” on page 77.
3. See “Installing the LCD Brackets” on page 77.
4. See “Installing the 15” TFT LCD” on page 78.
5. See “Installing the Inverter Board (15” LCD)” on page 78.
6. Attach the LCD bezel to the LCD module.



7. Fasten the LCD bezel with the four screws. Then cover the four screw pads.



Installing the LCD Module

Installing the LCD Module

1. Place the LCD module to the main unit.

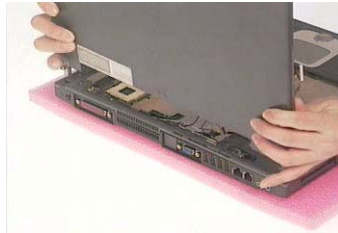

2. Fasten the LCD module with the two screws on the bottom; one on the right and another one on the left.



3. Secure the LCD hinge with the four screws; two on the right and two on the left.



4. Connect the inverter cable to the main board. Connect the LCD coaxial cable to the main board. Then fasten the LCD coaxial cable with one screw.



Installing the Launch Board

1. Attach the launch board to the middle cover. Then secure the launch board with the two screws as the picture shows.



Installing the Middle Cover

1. See "Installing the Launch Board" on page 81.
2. Connect the launch board cable to the launch board.

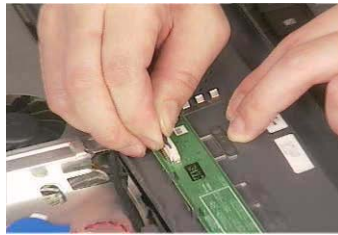

3. Attach the middle cover to the main unit carefully. Then close the LCD panel and fasten the middle cover with your fingers on its ridge.



4. Secure the middle cover with one screw as the picture shows.
5. Then attach the left hinge cap.



6. Secure the middle cover with one screw on another side as the picture shows.
7. Then attach the right hinge cap.



Installing the Hard Disk Drive Module

1. Insert the hard disk drive to the main unit. Then push it to the original position carefully.

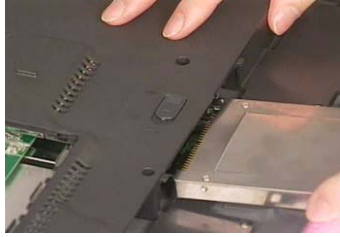

NOTE: Please attend the positive and negative of hard disk drive when insert the hard disk drive to the main unit.



Installing the Modem Board

1. Connect the modem cable to the modem board.



2. Place the modem board to the main unit carefully. Then fasten the modem board with the two screws.

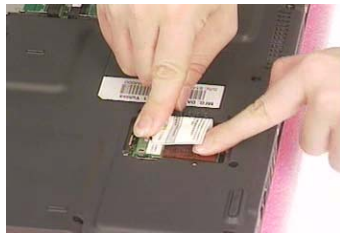

3. Place the modem cover back to the machine. Then secure the modem cover with one screw.



Installing the Memory Module

1. Insert the memory module to the DIMM slot.



2. Put the DIMM cover back to the machine.



3. Fasten the DIMM cover with the two screws.



Installing the Battery

1. Place the the battery back to the machine.



Troubleshooting

Use the following procedure as a guide for computer problems.

NOTE: The diagnostic tests are intended to test this model. Non-Acer products, prototype cards, or modified options can give false errors and invalid system responses.

1. Duplicate symptom and obtain the failing symptoms in as much detail as possible.
2. Distinguish symptom. Verify the symptoms by attempting to re-create the failure by running the diagnostic test or by repeating the same operation.
3. Disassemble and assemble the unit without any power sources.
4. If any problem occurs, you can perform visual inspection before you follow this chapter's instructions. You can check the following:
 - power cords are properly connected and secured;
 - there are no obvious shorts or opens;
 - there are no obviously burned or heated components;
 - all components appear normal.
5. Use the following table with the verified symptom to determine which page to go to.

Symptoms (Verified)	Go To
Power failure. (The power indicator does not go on or stay on.)	"Power System Check" on page 90.
POST does not complete. No beep or error codes are indicated.	"Power-On Self-Test (POST) Error Message" on page 92 "Undetermined Problems" on page 104
POST detects an error and displayed messages on screen.	"Error Message List" on page 93
Other symptoms (i.e. LCD display problems or others).	"Power-On Self-Test (POST) Error Message" on page 92
Symptoms cannot be re-created (intermittent problems).	Use the customer-reported symptoms and go to "Power-On Self-Test (POST) Error Message" on page 92 "Intermittent Problems" on page 103 "Undetermined Problems" on page 104

System Check Procedures

External Diskette Drive Check

Do the following to isolate the problem to a controller, driver, or diskette. A write-enabled, diagnostic diskette is required.

NOTE: Make sure that the diskette does not have more than one label attached to it. Multiple labels can cause damage to the drive or cause the drive to fail.

If an error occurs with the internal diskette drive, reconnect the diskette connector on the system board.

If the error still remains:

1. Reconnect the external diskette drive/DVD-ROM module.
2. Replace the external diskette drive/CD-ROM module.
3. Replace the main board.

External CD-ROM Drive Check

Do the following to isolate the problem to a controller, drive, or CD-ROM. Make sure that the CD-ROM does not have any label attached to it. The label can cause damage to the drive or can cause the drive to fail.

Do the following to select the test device:

1. See if CD-ROM Test is passed when the program runs to CD-ROM Test.
2. Follow the instructions in the message window.

If an error occurs, reconnect the connector on the System board. If the error still remains:

1. Reconnect the external diskette drive/CD-ROM module.
2. Replace the external diskette drive/CD-ROM module.
3. Replace the main board.

Keyboard or Auxiliary Input Device Check

Remove the external keyboard if the internal keyboard is to be tested.

If the internal keyboard does not work or an unexpected character appears, make sure that the flexible cable extending from the keyboard is correctly seated in the connector on the system board.

If the tests detect a keyboard problem, do the following one at a time to correct the problem. Do not replace a non-defective FRU:

1. Reconnect the keyboard cables.
2. Replace the keyboard.
3. Replace the main board.

The following auxiliary input devices are supported by this computer:

- Numeric keypad
- External keyboard

If any of these devices do not work, reconnect the cable connector and repeat the failing operation.

Memory check

Memory errors might stop system operations, show error messages on the screen, or hang the system.

1. Boot from the diagnostics diskette and start the doagmpstotics program (please refer to main board).
2. Go to the diagnostic memory in the test items.

-
3. Press F2 in the test items.
 4. Follow the instructions in the message window.

NOTE: Make sure that the DIMM is fully installed into the connector. A loose connection can cause an error.

Power System Check

To verify the symptom of the problem, power on the computer using each of the following power sources:

1. Remove the battery pack.
2. Connect the power adapter and check that power is supplied.
3. Disconnect the power adapter and install the charged battery pack; then check that power is supplied by the battery pack.

If you suspect a power problem, see the appropriate power supply check in the following list:

- “Check the Battery Pack” on page 91

Check the Battery Pack

To check the battery pack, do the following:

From Software:

1. Check out the Power Management in control Panel
2. In Power Meter, confirm that if the parameters shown in the screen for Current Power Source and Total Battery Power Remaining are correct.
3. Repeat the steps 1 and 2, for both battery and adapter.
4. This helps you identify first the problem is on recharging or discharging.

From Hardware:

1. Power off the computer.
2. Remove the battery pack and measure the voltage between battery terminals 1(+) and 6(ground). See the following figure
3. If the voltage is still less than 7.5 Vdc after recharging, replace the battery.

To check the battery charge operation, use a discharged battery pack or a battery pack that has less than 50% of the total power remaining when installed in the computer.

If the battery status indicator does not light up, remove the battery pack and let it return to room temperature. Re-install the battery pack.

If the charge indicator still does not light up, replace the battery pack. If the charge indicator still does not light up, replace the DC/DC charger board.

Touchpad check

If the touchpad doesn't work, do the following actions one at a time to correct the problem. Do not replace a non-defective FRU:

1. After rebooting, run Tracking Pad PS2 Mode Driver. For example, run Syn touch driver.
2. Run utility with the PS/2 mouse function and check if the mouse is working.
3. If the the PS/2 mouse does not work, then check if the main board to switch board FPC is connected O.K.
4. If the main board to switch board FPC is connected well, then check if the FCC on touch pad PCB connects properly.
5. If the FFC on touch pad PCB connects properly, then check if LS851 JP1 Pin6=5V are pulese. If yes, then replace switch board. If no, then go to next step.
6. Replace touch pad PCB.
7. If the touch pad still does not work, then replace FPC on Track Pad PCB.

After you use the touchpad, the pointer drifts on the screen for a short time. This self-acting pointer movement can occur when a slight, steady pressure is applied to the touchpad pointer. This symptom is not a hardware problem. No service actions are necessary if the pointer movement stops in a short period of time.

Power-On Self-Test (POST) Error Message

The POST error message index lists the error message and their possible causes. The most likely cause is listed first.

NOTE: Perform the FRU replacement or actions in the sequence shown in FRU/Action column, if the FRU replacement does not solve the problem, put the original part back in the computer. Do not replace a non-defective FRU.

This index can also help you determine the next possible FRU to be replaced when servicing a computer.

If the symptom is not listed, see “Undetermined Problems” on page 104.

The following lists the error messages that the BIOS displays on the screen and the error symptoms classified by function.

NOTE: Most of the error messages occur during POST. Some of them display information about a hardware device, e.g., the amount of memory installed. Others may indicate a problem with a device, such as the way it has been configured.

NOTE: If the system fails after you make changes in the BIOS Setup Utility menus, reset the computer, enter Setup and install Setup defaults or correct the error.

Index of Error Messages

Error Message List

Error Messages	FRU/Action in Sequence
Struck Key	See “Keyboard or Auxiliary Input Device Check” on page 89
System CMOS checksum bad - Default configuration used	RTC battery Run BIOS Setup Utility to reconfigure system, then reboot system.
Real time clock error	RTC battery Run BIOS Setup Utility to reconfigure system time, then reboot system. Main board
Previous boot incomplete - Default configuration used	“Load Default Settings” in BIOS Setup Utility. RTC batter Main board.
Invalid System Configuration Data	“Load Default Settings” in BIOS Setup Utility. Main board.
Operating system not found	Enter Setup and see if fixed disk and drive A are properly identified. Dikette drive Hard disk drive Main board.

Error Message List

No beep Error Messages	FRU/Action in Sequence
Power-on indicator turns off and LCD is blank.	Power source (battery pack and power adapter.) See "Power System Check" on page 90 Ensure every connector is connected tightly and correctly. Reconnect the DIMM. Main board.
Power-on indicator turns on and LCD is blank.	Power source (battery pack and power adapter.) See "Power System Check" on page 90 Reconnect the LCD connector Hard disk drive LCD cable LCD inverter LCD Main board
Power-on indicator turns on and LCD is blank. But you can see POST on an external CRT.	Reconnect the LCD connectors. LCD cable LCD inverter LCD Main board
Power-on indicator turns on and a blinking cursor shown on LCD during POST.	Ensure every connector is connected tightly and correctly. Main board

POST Codes

Code	Beeps	POST Routine Description
02h		Verify Real Mode
03h		Disable Non-Maskable Interrupt (NMI)
04h		Get CPU type
06h		Initialize system hardware
08h		Initialize chipset with initial POST values
09h		Set IN POST flag
0Ah		Initialize CPU registers
0Bh		Enable CPU cache
0Ch		Initialize caches to initial POST values
0Eh		Initialize I/O component
0Fh		Initialize the local bus IDE
10h		Initialize Power Management
11h		Load alternate registers with initial POST values
12h		Restore CPU control word during warm boot
13h		Initialize PCI Bus Mastering devices
14h		Initialize keyboard controller
16h	1-2-2-3	BIOS ROM checksum
17h		Initialize cache before memory autosize
18h		8254 timer initialization
1Ah		8237 DMA controller initialization
1Ch		Reset Programmable Interrupt Controller
20h	1-3-1-1	Test DRAM refresh
22h	1-3-1-3	Test 8742 Keyboard Controller
24h		Set ES segment register to 4 GB
26h		Enable A20 line
28h		Autosize DRAM
29h		Initialize POST Memory Manager
2Ah		Clear 215 KB base RAM
2Ch	1-3-4-1	RAM failure on address line xxxx
2Eh	1-3-4-3	RAM failure on data bits xxxx of low byte of memory bus
2Fh		Enable cache before system BIOS shadow
30h	1-4-1-1	RAM failure on data bits xxxx of high byte of memory bus
32h		Test CPU bus-clock frequency
33h		Initialize Phoenix Dispatch Manager
36h		Warm start shut down
38h		Shadow system BIOS ROM
3Ah		Autosize cache
3Ch		Advanced configuration of chipset registers
3Dh		Load alternate registers with CMOS values
42h		Initialize interrupt vectors
45h		POST device initialization

Code	Beeps	POST Routine Description
46h	2-1-2-3	Check ROM copyright notice
48h		Check video configuration against CMOS
49h		Initialize PCI bus and devices
4Ah		Initialize all video adapters in system
4Bh		QuietBoot start (optional)
4Ch		Shadow video BIOS ROM
4Eh		Display BIOS copyright notice
50h		Display CPU type and speed
51h		Initialize EISA board
52h		Test keyboard
54h		Set key click if enabled
58h	2-2-3-1	Test for unexpected interrupts
59h		Initialize POST display service
5Ah		Display prompt "Press F2 to enter SETUP"
5Bh		Disable CPU cache
5Ch		Test RAM between 512 and 640 KB
60h		Test extended memory
62h		Test extended memory address lines
64h		Jump to User Patch1
66h		Configure advanced cache registers
67h		Initialize Multi Processor APIC
68h		Enable external and CPU caches
69h		Setup System Management Mode (SMM) area
6Ah		Display external L2 cache size
6Bh		Load custom defaults (optional)
6Ch		Display shadow-area message
6Eh		Display possible high address for UMB recovery
70h		Display error messages
72h		Check for configuration errors
76h		Check for keyboard errors
7Ch		Set up hardware interrupt vectors
7Eh		Initialize coprocessor if present
80h		Disable onboard Super I/O ports and IRQs
81h		Late POST device initialization
82h		Detect and install external RS232 ports
83h		Configure non-MCD IDE controllers
84h		Detect and install external parallel ports
85h		Initialize PC-compatible PnP ISA devices
86h		Re-initialize onboard I/O ports
87h		Configure Motherboard Configurable Devices (optional)
88h		Initialize BIOS Area
89h		Enable Non-Maskable Interrupts (NMI)
8Ah		Initialize Extended BIOS Data Area
8Bh		Test and initialize PS/2 mouse

Code	Beeps	POST Routine Description
8Ch		Initialize floppy controller
8Fh		Determine number of ATA drives (optional)
90h		Initialize hard-disk controllers
91h		Initialize local-bus hard-disk controllers
92h		Jump to UserPatch2
93h		Build MPTABLE for multi-processor boards
95h		Install CD ROM for boot
96h		Clear huge ES segment register
97h		Fixup Multi Processor table
98h	1-2	Search for option ROMs. One long, two short beeps on checksum failure.
99h		Check for SMART drive (optional)
9Ah		Shadow option ROMs
9Ch		Set up Power Management
9Dh		Initialize security engine (optional)
9Eh		Enable hardware interrupts
9Fh		Determine number of ATA and SCSI drives
A0h		Set time of day
A2h		Check key lock
A4h		Initialize Typematic rate
A8h		Erase F2 prompt
AAh		Scan for F2 key stroke
ACh		Enter SETUP
AEh		Clear Boot flag
B0h		Check for errors
B2h		POST done- prepare to boot operating system
B4h	1	One short beep before boot
B5h		Terminate QuietBoot (optional)
B6h		Check password (optional)
B9h		Prepare Boot
BAh		Initialize DMI parameters
BBh		Initialize PnP Option ROMs
BCh		Clear parity checkers
BDh		Display MultiBoot menu
BEh		Clear screen (optional)
BFh		Check virus and backup reminders
C0h		Try to boot with INT 19
C1h		Initialize POST Error Manager (PEM)
C2h		Initialize error logging
C3h		Initialize error display function
C4h		Initialize system error handler
C5h		PnPnd dual CMOS (optional)
C6h		Initialize notebook docking (optional)
C7h		Initialize notebook docking late
C8h		Force check (optional)
C9h		Extended checksum (optional)

Code	Beeps	POST Routine Description
D2h		Unknown interrupt

Code	Beeps	For Boot Block in Flash ROM
E0h		Initialize the chipset
E1h		Initialize the bridge
E2h		Initialize the CPU
E3h		Initialize the system timer
E4h		Initialize system I/O
E5h		Check force recovery boot
E6h		Checksum BIOS ROM
E7h		Go to BIOS
E8h		Set Huge Segment
E9h		Initialize Multi Processor
EAh		Initialize OEM special code
EBh		Initialize PIC and DMA
ECh		Initialize Memory type
EDh		Initialize Memory size
EEh		Shadow Boot Block
EFh		System memory test
F0h		Initialize interrupt vectors
F1h		Initialize Run Time Clock
F2h		Initialize video
F3h		Initialize System Management Mode
F4h	1	Output one beep before boot
F5h		Boot to Mini DOS
F6h		Clear Huge Segment
F7h		Boot to Full DOS

Index of Symptom-to-FRU Error Message

LCD-Related Symptoms

Symptom / Error	Action in Sequence
LCD backlight doesn't work	First, plug a monitor to CRT port. Next, enter BIOS utility to running "Load Default Settings" then reboot the system. Reconnect the LCD connectors. Keyboard (if the brightness function key doesn't work). LCD cable LCD inverter LCD Main board
LCD is too dark LCD brightness cannot be adjusted	Enter BIOS Utility to execute "Load Setup Default Settings", then reboot system. Reconnect the LCD connectors. Keyboard (if the brightness function key doesn't work). LCD cable LCD inverter LCD Main board
Unreadable LCD screen Missing pels in characters Abnormal screen Wrong color displayed LCD has extra horizontal or vertical lines displayed.	Reconnect the LCD cable LCD cable LCD Main board

Indicator-Related Symptoms

Symptom / Error	Action in Sequence
Indicator incorrectly remains off or on, but system runs correctly	Main board
HDD/CD-ROM active indicators cannot work	HDD/CD-ROM drive Device driver Main board

Power-Related Symptoms

Symptom / Error	Action in Sequence
Power shuts down during operation	Power source (battery pack and power adapter). See "Power System Check" on page 90. Battery pack AC adapter See if the thermal module is overheat (Heat sink or fan). Main board
The system cannot power-on.	Power source (battery pack and power adapter). See "Power System Check" on page 90. Battery pack Power adapter CPU Main board
The system cannot power-off.	In Windows XP operating system, hold and press the power switch for more than 4 seconds. If the system can power off, then the main board is OK. Verify OS in the HDD. Main board

Power-Related Symptoms

Symptom / Error	Action in Sequence
Battery can't be charged or discharged	See "Check the Battery Pack" on page 91. Battery pack Main board
System hang during POST	ODD/HDD/FDD/RAM module Main board

PCMCIA-Related Symptoms

Symptom / Error	Action in Sequence
System cannot detect the PC Card (PCMCIA)	PCMCIA slot assembly Main board
PCMCIA slot pin is damaged.	PCMCIA slot assembly
PC Card cannot be inserted or ejected	Check if the PCMCIA slot is blocked Main board

Memory-Related Symptoms

Symptom / Error	Action in Sequence
Memory count (size) appears different from actual size.	Enter BIOS Setup Utility to execute "Load Default Settings" then reboot system. RAM module Main board Check BIOS revision
System can power on, but you hear two long beeps: "B--, B--" and the LCD is blank.	Reinsert DIMM DIMM Main board

Speaker-Related Symptoms

Symptom / Error	Action in Sequence
In Windows, multimedia programs, no sound comes from the computer.	OS volume control Audio driver Speaker Main board
Internal speakers make noise or emit no sound.	Speaker Main board
Microphone cannot work	Audio driver Volume control in Windows XP Main board

Power Management-Related Symptoms

Symptom / Error	Action in Sequence
The system will not enter hibernation mode	Power option in Windows XP Hard disk drive Main board
The system doesn't enter standby mode after closing the lid of the portable computer.	Driver of Power Option Properties Lid close switch in upper case Main board

Power Management-Related Symptoms

Symptom / Error	Action in Sequence
The system doesn't resume from hibernation/standby mode.	Connect AC adapter then check if the system resumes from Standby/Hibernation mode. Check if the battery is low. Hard disk drive Main board
The system doesn't resume from standby mode after opening the lid of the portable computer.	LCD cover switch Main board
Battery fuel gauge in Windows doesn't go higher than 90%.	Refresh battery (continue use battery until power off, then charge battery). Battery pack Main board
System hangs intermittently.	Reconnect hard disk/CD-ROM drives. Main board

Peripheral-Related Symptoms

Symptom / Error	Action in Sequence
System configuration does not match the installed devices.	Enter BIOS Setup Utility to execute "Load Setup defaults", then reboot system. Reconnect hard disk/CD-ROM drives/FDD or other peripherals. Main board
External display does not work correctly.	Press Fn+F5, LCD/CRT/Both display switching Keyboard Main board
USB does not work correctly	Main board
Print problems.	Enter BIOS Setup Utility to execute "Load Default Settings" then reboot the system. Run printer self-test. Printer driver Printer cable Printer Main board
Parallel port device problems	Enter BIOS Setup Utility to execute "Load Default Settings" then reboot the system. Device driver Device cable Device Main board

Keyboard/Touchpad-Related Symptoms

Symptom / Error	Action in Sequence
Keyboard (one or more keys) does not work.	Reconnect the keyboard cable. Keyboard Main board
Touchpad does not work.	Reconnect touchpad cable. Touchpad board Main board

Modem/LAN-Related Symptoms

Symptom / Error	Action in Sequence
Internal modem does not work correctly.	Phone cable Driver Reconnect the Internal modem cable to the main board tightly. Main board
Internal LAN does not work correctly	Lan cable Driver Main board

NOTE: If you cannot find a symptom or an error in this list and the problem remains, see “Undetermined Problems” on page 104.

Intermittent Problems

Intermittent system hang problems can be caused by a variety of reasons that have nothing to do with a hardware defect, such as: cosmic radiation, electrostatic discharge, or software errors. FRU replacement should be considered only when a recurring problem exists.

When analyzing an intermittent problem, do the following:

1. Run the diagnostic test for the system board in loop mode at least 10 times.
2. If no error is detected, do not replace any FRU.
3. If any error is detected, replace the FRU. Rerun the test to verify that there are no more errors.

Undetermined Problems

The diagnostic problems does not identify which adapter or device failed, which installed devices are incorrect, whether a short circuit is suspected, or whether the system is inoperative.

Follow these procedures to isolate the failing FRU (do not isolate non-defective FRU).

NOTE: Verify that all attached devices are supported by the computer.

NOTE: Verify that the power supply being used at the time of the failure is operating correctly. (See “Power System Check” on page 90):

1. Power-off the computer.
2. Visually check them for damage. If any problems are found, replace the FRU.
3. Remove or disconnect all of the following devices:
 - Non-Acer devices
 - Printer, mouse, and other external devices
 - Battery pack
 - Hard disk drive
 - DIMM
 - PC Cards
4. Power-on the computer.
5. Determine if the problem has changed.
6. If the problem does not recur, reconnect the removed devices one at a time until you find the failing FRU.
7. If the problem remains, replace the following FRU one at a time. Do not replace a non-defective FRU:
 - System board
 - LCD assembly

Jumper and Connector Locations

Top View

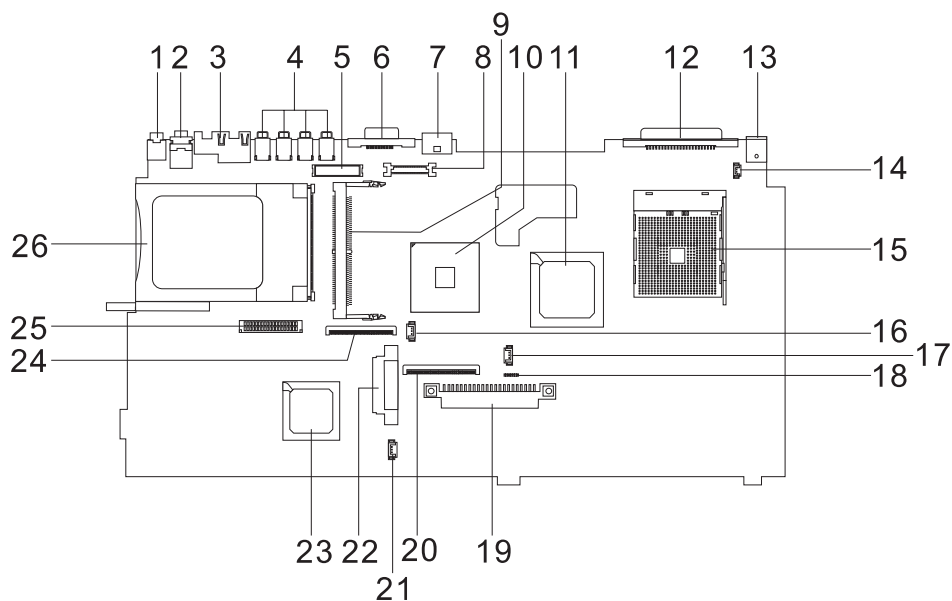

1	LIN1	Line-in/MIC Connector	14	CN1	Switch Cable Connector (LCD Lid Switch)
2	LOUT1	Line-out/S/PDIF Connector	15	U20	CPU Socket
3	JR1	LAN Connector	16	RTC1	RTC Battery Connector
4	USB1, USB2, USB3, USB4	USB Connector	17	FAN1	Fan Cable Connector
5	INV1	LCD Inverter Cable Connector	18	TPAD1	Touchpad Cable Connector
6	CRT1	CRT Connector	19	HDD1	HDD Connector
7	TV1	TV-out Connector	20	KB1	Keyboard Connector
8	LCD1	LCD Coaxial Cable Connector	21	SPK1	Speaker Connector
9	WIN1	Mini PCI Socket	22	IDE1	ODD Connector
10	U23	VGA Chip	23		South Bridge
11		North Bridge	24	FDD1	FDD Connector
12	PRT1	Printer Connector	25	CN7	Launch Cable Connector
13	DCIN1	AC Adapter Connector	26	MINI1	PCMCIA Slot

Bottom View

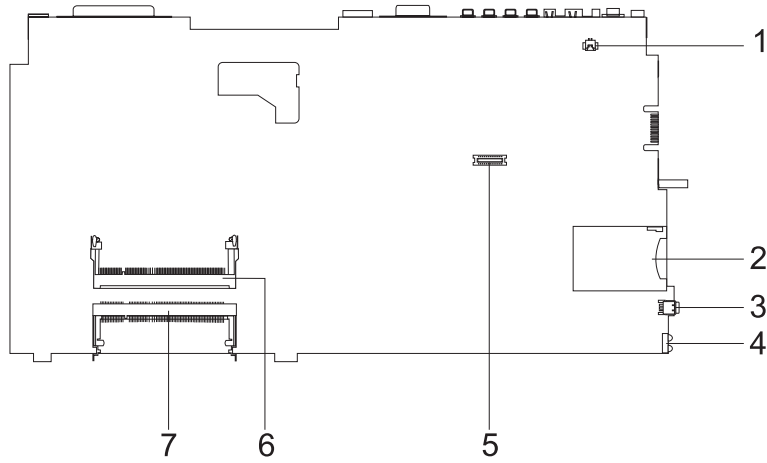

- 1 CN3 Modem Cable Connector
- 2 CN6 Card Reader Slot
- 3 1394_1 IEEE 1394 Connector
- 4 IR1 IR Connector
- 5 CN8 Modem Board Connector
- 6 DM1 DIMM Socket 1
- 7 DM2 DIMM Socket 2

SW1

SW1-1	Change Passwork
On	Enabled
Off	Disabled

SW1-2	BIOS Bootblock Erasable
On	Enabled
Off	Disabled

FRU (Field Replaceable Unit) List

This chapter gives you the FRU (Field Replaceable Unit) listing in global configurations of Aspire 1500. Refer to this chapter whenever ordering for parts to repair or for RMA (Return Merchandise Authorization).





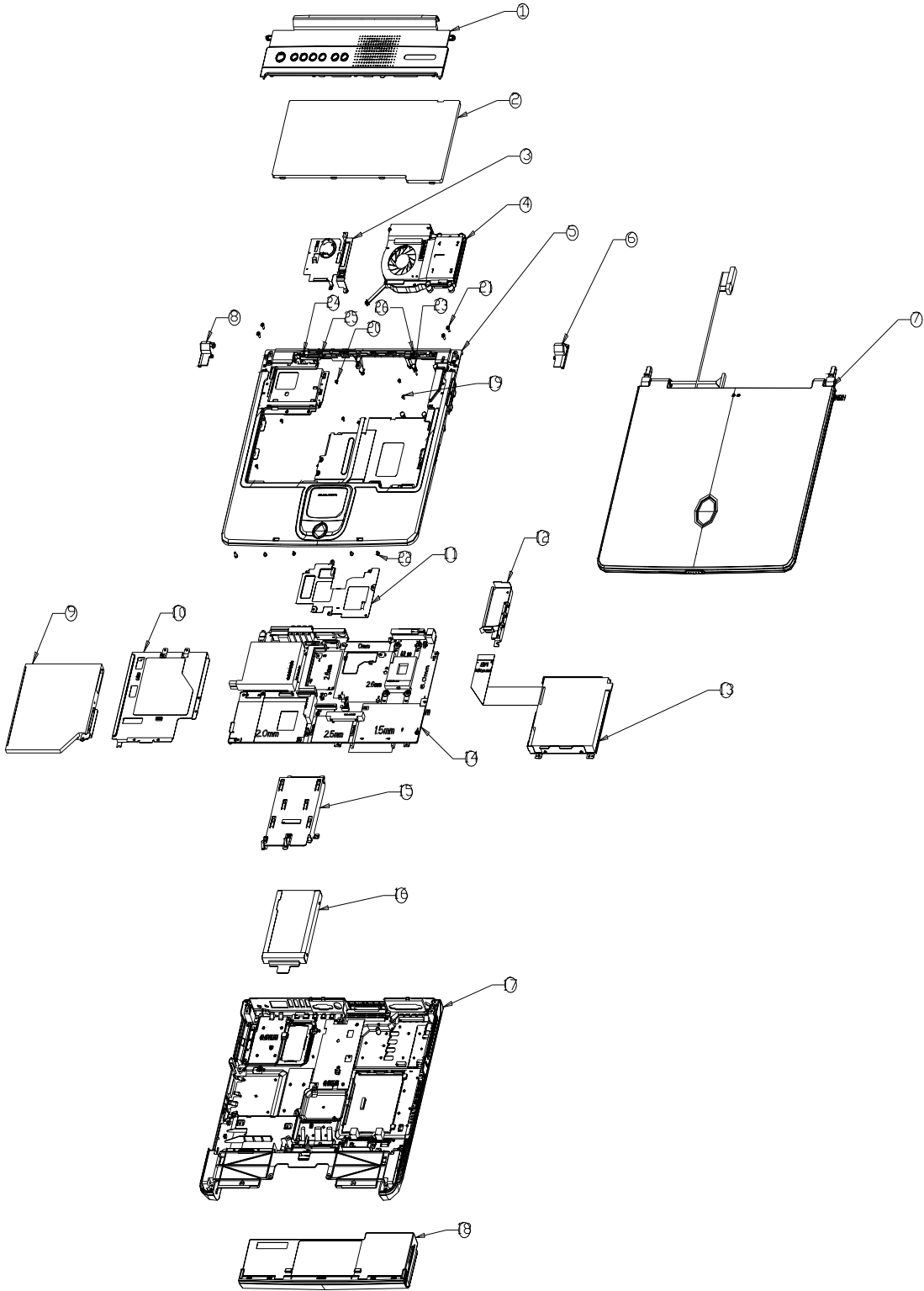

Please note that WHEN ORDERING FRU PARTS, you should check the most up-to-date information available on your regional web or channel. For whatever reasons a part number change is made, it will not be noted on the printed Service Guide. For ACER AUTHORIZED SERVICE PROVIDERS, your Acer office may have a DIFFERENT part number code from those given in the FRU list of this printed Service Guide. You MUST use the local FRU list provided by your regional Acer office to order FRU parts for repair and service of customer machines.

NOTE: To scrap or to return the defective parts, you should follow the local government ordinance or regulations on how to dispose it properly, or follow the rules set by your regional Acer office on how to return it.

Exploded Diagram



Picture	No.	Partname And Description	Part Number
Adapter			
	NS	ADAPTER 120W 3PIN LITEON PA-1121-02AC	AP.T3003.002
Battery			
	NS	RTC BATTERY	23.T30V1.101
	18	BATTERY MODULE 12CELL SONY W/COVER	6M.A16V1.001
	NS	BATTERY 12CELL SONY W/O COVER	BT.A1604.002
CASE/COVER/BACKET ASSEMBLY			
	NS	BATTERY COVER	42.T30V1.001
Boards			
	NS	MODEM BOARD AMBIT AMBIT T60M283.10(01)	54.09011.544
	NS	BLUETOOTH & MODEM BOARD AMBIT T60M665.00	54.09061.001
	NS	WIRELESS LAN BOARD 802.11G WNC	54.A16V1.001

Picture	No.	Partname And Description	Part Number
	NS	WIRELESS LAN BOARD 802.11ABG WNC	54.A16V1.002
	NS	DC-DC CHARGER BOARD	55.T30V1.001
	NS	LAUNCH BOARD	55.T30V1.002
Cables			
	NS	POWER CORD 125V 3PIN US	27.T30V1.001
		POWER CORD 3A 250V 3PIN UK	27.T30V1.003
		POWER CORD 10A 250V 2PIN EUROPE CONTINENTAL	27.T30V1.004
		POWER CORD 10A 250V AF	27.T30V1.005
		POWER CORD 10A 250V SWISS	27.T30V1.006
		POWER CORD 10A DEMARK	27.T30V1.007
		POWER CORD 10A 250V ITALIAN	27.T30V1.008
	NS	COVER SWITCH CABLE	50.T30V1.002
	NS	MODEM CABLE	50.41T11.002
	NS	LAUNCH BOARD CABLE	50.A16V1.006
Case/Cover/Bracket Assembly			
	10	OPTICAL DEVICE SUPPORT BRACKET	33.T30V1.001

Picture	No.	Partname And Description	Part Number
	15	HDD BRACKET	33.T30V1.002
	16	HDD HOLDER	33.T30V1.003
	6	HINGE CAP RIGHT	42.T30V1.002
	8	HINGE CAP LEFT	42.T30V1.003
	NS	TOUCHPAD COVER	42.T30V1.006
	17	LOWER CASE W/DIMM COVER & FOOT & MODEM COVER & SPEAKER	60.A106V1.001
	NS	MODEM COVER W/SCREW	42.T30V1.004
	NS	DIMM COVER W/SCREW	42.A16V1.001



Picture	No.	Partname And Description	Part Number
	19	UPPER CASE W/O TOUCHPAD & TOUCHPAD COVER & TOUCHPAD KNOB BUTTON W/ COVER SWITCH CABLE & TOUCHPAD CABLE & SCROLL KEY BUTTON	60.A16V1.002
	1	MIDDLE COVER W/LAUNCH BOARD W/NAME PLATE	T60.A16V1.003
Communication Module			
	NS	BLUETOOTH ANTENNA	50.A16V1.001
	NS	WIRELESS ANTENNA RIGHT (BLACK-MAIN)	50.A16V1.002
	NS	WIRELESS ANTENNA LEFT (GRAY-AUX)	50.A16V1.003
CPU			
	NS	AMD ATHLON 64 HAMMER MOBILE 3000+ 1.8GHZ	KC.A3002.89H
		AMD ATHLON 64 HAMMER MOBILE 3200+ 2.0GHZ	KC.A3202.89H
FDD/Floppy Disk Drive			
	13	FDD MODULE 1.44M PANASONIC JU-226A033	6M.A16V1.009
	NS	FDD DRIVE 1.44M PANASONIC JU-226A033	KF.T3007.001

Picture	No.	Partname And Description	Part Number
	NS	FDD BRACKET	33.T30V1.005
	NS	FDD CABLE	50.A16V1.004
HDD/ Hard Disk Drive			
	NS	HDD 40G 2.5 IN. 420RPM TOSHIBA PLUTO MK4025GAS	KH.04004.002
		HDD 60GB 2.5 IN. 4200RPM HGST MORAGA IC25N060ATMR04-0 08K0634	KH.06007.002
		HDD 60GB/2.5 IN./4200RPM/ TOSHIBA NEPTUNE MK6021GAS	KH.36004.001
		HDD 60G HGST HTS548060M9AT00	KH.06007.003
Heatsink			
	11	VGA HEATSINK PLATE	34.A16V1.004
	12	CPU HEATSINK PLATE	34.A16V1.003
	4	CPU FANSINK	34.A16V1.001
Keyboard			

Picture	No.	Partname And Description	Part Number
	2	KEYBOARD DARFON NSK-AC61D US-INT	KB.T3007.001
		KEYBOARD SUNREX K020830T1/UI US-INT	KB.T3009.001
		KEYBOARD 85KEY SPANISH DARFON NSK-AC60S	KB.T3007.003
		KEYBOARD 84KEY THAI DARFON NSK-AC603	KB.T3007.004
		KEYBOARD 85KEY BAZILIAN PROTUGESE DARFON NSK-AC61B	KB.T3007.005
		KEYBOARD 85KEY UK DARFON NSK-AC60U	KB.T3007.006
		KEYBOARD 85KEY GERMAN DARFON NSK-AC60G	KB.T3007.007
		KEYBOARD 85KEY ITALIAN DARFON NSK-AC60E	KB.T3007.008
		KEYBOARD 85KEY FRENCH DARFON NSK-AC60F	KB.T3007.009
		KEYBOARD 85KEY SWISS/G DARFON NSK-AC600	KB.T3007.010
		KEYBOARD 85KEYS PORTUGUESE DARFON NSK-AC606	KB.T3007.011
		KEYBOARD 84KEY CZECH DARFON NSK-AC60C	KB.T3007.013
		KEYBOARD 84KEY CZECH DARFON NSK-AC60C	KB.T3007.015
		KEYBOARD 85KEY HUNGAIAN DARFON NSK-AC60Q	KB.T3007.016
	KEYBOARD 84KEY RUSSIAN DARFON NSK-AC60R	KB.T3007.022	
LCD			
	7	ASSEMBLY LCD 15" TFT SXGA+ AU B150PG01	6M.A16V1.010
	NS	LCD 15 IN. TFT SXGA+ AU B150PG01	LK.15005.002
	NS	INVERTER BOARD DARFON	19.21030.I71

Picture	No.	Partname And Description	Part Number
	NS	LCD BRACKET RIGHT	33.T30V1.009
	NS	LCD BRACKET LEFT	33.T30V1.008
	NS	INVERTER CABLE	50.T30V1.007
	NS	LCD COAXIAL CABLE 15"	50.A16V1.005
	NS	LCD PANEL W/HINGE & LOGO	60.A16V1.005
	NS	LCD BEZEL 15.1" W/ICON PLATE	60.A16V1.004
	NS	HINGE PACK	6K.T30V1.001
Main Board			
	NS	MAINBOARD W/O CPU & DC BOARD W/BRACKET & LAUNCH BOARD CABLE & MODEM CABLE & PCMCIA SLOT & RTC BATTERY	MB.A1601.001
Memory			

Picture	No.	Partname And Description	Part Number
	NS	MEMORY DDR333 256MB MICRON MT8VDDT3264HDG-335C3	KN.25604.009
	NS	MEMORY DDR333 256MB SAMSUNG M470L3224FT0-CB3	KN.2560B.008
	NS	MEMORY DDR333 256MB NANYA NT256D64SH8BAGM-6K	KN.25603.009
Miscellaneous			
	NS	LOGO	31.42S08.001
	NS	SCREW RUBBER LOWER	47.A16V1.001
	NS	SCREW RUBBER UPPER	47.A16V1.002
	NS	ICON PLATE	40.A16V1.001
	NS	NAME PLATE	40.A16V1.002
	NS	RUBBER FOOT	47.T30V1.003
	NS	TOUCHPAD KNOB	42.T30V1.008
	NS	ICON LABEL	40.T30V1.001
Optical Drive			
	9	DVD-RW MODULE 2X PIONEER DVR-K12D	TBD
	NS	DVD-RW DRIVE 2X PIONEER DVR-K12D	KU.00405.008
	NS	OPTICAL DRIVE BRACKET	33.T30V1.004
PCMCIA slot/PC card slot			

Picture	No.	Partname And Description	Part Number
	NS	PCMCIA SLOT	22.T30V1.001
Pointing Device			
	NS	TOUCHPAD SYNAPTICS TM41P-357	56.17001.001
Speaker			
	NS	SPEACK PACK LEFT/RIGHT	23.T30V1.002
Screws			
	NS	SCREW	34.00015.081
	NS	SCREW	86.00B54.630
	NS	SCREW	86.9A352.3R0
	NS	SCREW	86.9A353.6R0
	NS	SCREW	86.9A524.4R0
	NS	SCREW	86.9A552.2R0
	NS	SCREW	86.9A552.3R0
	NS	SCREW	86.9A552.4R0
	NS	SCREW	86.9A553.3R0
	NS	SCREW	86.9A553.4R0

Model Definition and Configuration

Aspire 1500 Series

Model Number	CPU	LCD	Memory	HDD (GB)	ODD	Card Reader	Wireless LAN
1501LMi	Athlon 64 3000+	15.0" SXGA+	256x2	60G	4xDVD Dual	3-in-1	11g
1502LMi	Athlon 64 3200+	15.0" SXGA+	256x2	60G	4xDVD Dual	3-in-1	11g

Test Compatible Components

This computer's compatibility is tested and verified by Acer's internal testing department. All of its system functions are tested under Windows® XP Home environment.

Refer to the following lists for components, adapter cards, and peripherals which have passed these tests. Regarding configuration, combination and test procedures, please refer to the Aspire 1500 series Compatibility Test Report released by the Acer Mobile System Testing Department.

Microsoft® Windows® XP Environment Test

Item	Specifications
Processor	AMD Athlon 64 3200+ (2.0GHz) AMD Athlon 64 3000+ (1.8GHz)
Memory	256MB DDR333 Micron MT8VDDT3264HDG-335C3 Samsung M470L3224FT0-CB3 Nan-Ya NT256D64SH8BAGM-6K (.14u) 512MB DDR333 Infineon HYS64D64020GBDL-6-B Elpida EBD52UC8AARA-6B Samsung M470L6423DN0-CB3
LCD	14.1" XGA TFT AU B141XN04 V.2 Driver IC: 5Axxx CMO CMO N141X6-L01 15" XGA TFT AU B150XG01 V.2 Hitachi TX38D81VC1CAB CMO N150X3-L05
Hard Disk Drive	30GB IBM HGST Moraga IC25N030ATMR04-0 30GB Toshiba Neptune MK3021GAS 40GB IBM HGST Moraga IC25N040ATMR04-0 40GB Toshiba Neptune MK4021GAS 40GB HGST Moraga HTS548060M9AT00 08K0637 2.5" 5400RPM 40GB SEAGATE NEPTUNE ST94011A 5400/2MB,f/w3.04 60GB IBM HGST Moraga IC25N060ATMR04-0 60GB Toshiba Neptune MK6021GAS 60GB HGST Moraga HTS548060M9AT00 08K0638 2.5" 5400RPM 60GB Toshiba Triton MK6022GAX 2.5" 5400RPM 80GB HGST Moraga HTS548080M9AT00 08K0639 2.5" 5400RPM
Floppy Disk Drive	Mitsumi D353G 4515 MCI JU-226A033
DVD-ROM Drive 8X	MKE SR-8177
CD-ROM Drive 24X	Mitsumi SR-224W1
DVD/CD-RW Combo	KME UJDA750-740 QSI SBW-242 HLDS GCC-4241N
DVD-Dual	Pioneer DVR-K12D HLDS GWA-4040N KME UJ-820B
AC Adapter (3 pin)	Liteon TA 1121-02AW 120W
Power Cord	King Cord
Battery Li-Ion, 12cells	Sanyo Battery BTP-56E6 95W 12Cell
Network Adapters	
LAN Ethernet/10baseT/100baseT	3Com Etherlink III 3C589D IBM EtherJet CardBus Adapter 10/100 Intel Ether Express Pro/100 Mobile Adapter MBLA3200 Xircom CardBus Ethernet 10/100 32 Bit CBE-10/100BTX

Item	Specifications
Multifunction Card (Combo)	3Com Megahertz 10/100 LAN + 56K Modem PC Card Xircom RealPort CardBus Ethernet 10/100 + Modem 56
LAN Token Ring	IBM Token Ring 16/4 Adapter II
Wireless LAN Card	IBM Wireless LAN Cardbus Adapter Intel Pro-Wireless LAN PC Card Proxim Skyline 802.11a Cardbus PC Card Cisco Aironet 350 series Wireless Lan Card NeWeb Wireless Lan Card 802.11b
Modem Adapters	
Modem (up to 56K)	3Com Megahertz 56K Modem PC Card Xircom Credit Card Modem 56 IBM 56K Double Jack Modem
ISDN	US Robotics Megahertz 128K ISDN Card 405R17T7117M IBM OBI International ISDN PC Card
I/O Peripheral	
I/O - Display	Acer 211c 21" Viewsonic PF790 19" Acer FP751 17" TFT LCD IBM Color TFT LCD 14" Compaq Color Monitor NET Color Monitor 20" Mozo 17" TFT LCD (DVI)
I/O - Projector	NEC MultiSync MT-1040
I/O - Parallel (Printer/Scanner)	Canon BJC-600J Epson Stylus Color 740 Parallel Interface HP DeskJet 890C HP DeskJet 880C Parallel Interface HP LaserJet 6MP HP LaserJet 2200
I/O - USB Keyboard/Mouse	Chicony USB Keyboard KU-8933 Microsoft Natural Keyboard Pro Acer Aspire USB mouse Logicool US Mouse Logitech Cordless MouseMan Wheel USB Interface Logitech USB Wheel Mouse M-BB48 Microsoft IntelliMouse Optical USB Interface
I/O - PS2 (Serial) Keyboard/Mouse	IBM 101 key keyboard IBM 109 key keyboard Acer PS2 keyboard Acer KB-101A IBM Numeric Keypad III IBM Numeric Keypad Acer Mouse IBM PS2 Mini Mouse IBM PS2 Mouse Logitech Cordless MouseMan Wheel PS2 interface Logitech Serial Mouse M-M35 Microsoft IntelliMouse PS2 interface Microsoft IntelliMouse Optical PS2 interface Logitech First Mouse Three Button Serial Mouse

Item	Specifications
I/O - USB (Printer/Scanner)	Epson Stylus Color 740 USB interface HP DeskJet 880C USB interface Canon CanonScan D1250 (USB 2.0, JP OS only) HP ScanJet 3300C Color Scanner
I/O - USB (Speaker/Joystick)	JS USB Digital Speaker Panasonic USB Speaker EAB-MPC57USB AIWA Multimedia Digital Speaker Microsoft SideWinder Precision Pro Joystick Logitech WingMan RumblePad
I/O - USB Camera	Intel Easy PC Camera Logitech QuickCam Express Internet Logitech QuickCam Home PC Video Camera Orange Micro USB 2.0 Web Cam
I/O - USB Storage Drive	Logitech CDRW +DVDROM combo USB interface Iomega USB Zip 250MB
I/O-USB Flash Drive	IBM 32MB USB Memory key Apacer USB Handy Drive 32MB Apacer USB Handy Drive 256MB
I/O - USB Hub	Belkin 4 Port USB Hub Eizo I Station USB Hub Elecom USB Hub 4 Port Sanwa USB Hub 4 Port 4 Port Hub USB 2.0
I/O - Access Point (802.11b)	Hitachi DC-CN3300 Lucent RG-1000 Lucent WavePoint-II Cisco Aironet 350 Orinoco AP-500
I/O Access Point (802.11a/b)	Intel Dual Pro/Wireless 5000
I/O Access Point (802.11a)	Intel Pro/Wireless 5000
PCMCIA	
PCMCIA - ATA	IBM Microdrive 340MB IBM Microdrive 1G Iomega Click! 40MB Sony Memory Stick 64MB Apacer SD Flash Card 128MB Transcedn SD Card 32MB
PCMCIA - USB 2.0	Apricorn EZ-USB2.0 Cardbus PC Card DTK USB 2.0 2Port CardBus Host Controller Adaptec USB2CONNECT
PCMCIA - 1394	Buffalo 1394 Interface Cardbus IFC-ILCB/DV I-O Data 1394 Interface Cardbus CB1394/DVC Pixela 1394 Cardbus PC Card PIX-PCMC/FW1
PCMCIA-SCSI	Adaptec 1408 or B SCSI CB NewMedia Bus Toaster SCSI II
PCMCIA - Bluetooth	IBM Community Bluetooth PC Card Toshiba Bluetooth PC Card

Online Support Information

This section describes online technical support services available to help you repair your Acer Systems.

If you are a distributor, dealer, ASP or TPM, please refer your technical queries to your local Acer branch office. Acer Branch Offices and Regional Business Units may access our website. However some information sources will require a user i.d. and password. These can be obtained directly from Acer CSD Taiwan.

Acer's Website offers you convenient and valuable support resources whenever you need them.

In the Technical Information section you can download information on all of Acer's Notebook, Desktop and Server models including:

- Service guides for all models
- User's manuals
- Training materials
- Bios updates
- Software utilities
- Spare parts lists
- TABs (Technical Announcement Bulletin)

For these purposes, we have included an Acrobat File to facilitate the problem-free downloading of our technical material.

Also contained on this website are:

- Detailed information on Acer's International Traveler's Warranty (ITW)
- Returned material authorization procedures
- An overview of all the support services we offer, accompanied by a list of telephone, fax and email contacts for all your technical queries.

We are always looking for ways to optimize and improve our services, so if you have any suggestions or comments, please do not hesitate to communicate these to us.

A

AC Adapter 24
 AFLASH Utility 41
 Audio 18

B

Battery 23
 battery pack
 charging indicator 11
 BIOS 18
 package 18
 ROM size 18
 ROM type 18
 vendor 18
 Version 18
 BIOS Setup Utility 28
 BIOS Supports protocol 18
 BIOS Utility 28
 Basic System Settings 33
 Navigating 29
 Onboard Device Configuration 36
 Startup Configuration 35
 System Information 29
 System Security 40
 Board Layout 4
 Bottom View 5
 Top View 4
 brightness
 hotkeys 15

C

Cache
 controller 18
 size 18
 caps lock
 on indicator 11
 CardBus 22
 Chipsets 18
 computer
 on indicator 11, 12
 contrast
 hotkeys 15
 Controllers 18
 Core logic 18
 CPU
 core voltage 18
 I/O voltage 18

package 18
 type 18

D

DC-AC LCD Inverter 23
 DIMM
 Combinations 19
 Disassembly
 Battery Pack 45
 Procedure Flowchart 44
 Display 2
 display
 hotkeys 15
 Display Standby Mode 25

E

Environmental Requirements 25
 Error Symptom-to-Spare Part Index 92
 External CD-ROM Drive Check 89
 External Diskette Drive Check 89

F

Features 1
 Flash Utility 41
 Floppy Disk Drive Interface 20
 FRU (Field Replaceable Unit) List 108

H

Hard disk 18, 20
 Hard Disk Drive Module
 Disassembly 49
 Hard Disk Standby Mode 25
 Hardware Specifications and Configurations 18
 HDD 18, 20
 Hibernation Mode 25
 Hibernation mode
 hotkey 15
 Hot Keys 15

I

Indicators 11
 Intermittent Problems 103

J

Jumper and Connector Locations 106
 Top View 106

Bottom View 107

K

Keyboard 18, 23
Keyboard or Auxiliary Input Device Check 89

L

L2 cache 18
LCD 23

M

Mechanical Specification 26
media access
 on indicator 11
Memory Check 89
Model Definition 119
Modem 19

N

Notebook Manager
 hotkey 15
num lock
 on indicator 11

O

Online Support Information 124

P

Panel 5
 Bottom 10
 right 8
Parallel Port 22
PC Card 11, 22
PCMCIA 22
Power Management 25
Power System Check 90
 Battery Pack 91

R

Removing the Battery Pack 46

S

Second Level Cache 18
speakers
 hotkey 15
Standby Mode 25
Super I/O 18
System

Layout 4

System Diagnostic Diskette 41
System Memory 18
System Utilities 28
System Utility Diskette 41

T

Temperature 25
Test Compatible Components 120
Touchpad 18
touchpad
 hotkey 15
Touchpad Check 91
Troubleshooting 88

U

Undetermined Problems 104
USB 22
utility
 BIOS 28

V

Video 21
 Resolutions 22
Video controller 18

W

Windows 2000 Environment Test 121
Windows XP Environment Test 121

