

Aspire 1606 Service Guide

Service guide files and updates are available on the CSD web; for more information, please refer to <http://csd.acer.com.tw>

PART NO.:

PRINTED IN TAIWAN

Revision History

Please refer to the table below for the updates made on Aspire 1606 service guide.

Date	Chapter	Updates
2003/11/18	Chapter 4	Add POST codes

Copyright

Copyright © 2003 by Acer Incorporated. All rights reserved. No part of this publication may be reproduced, transmitted, transcribed, stored in a retrieval system, or translated into any language or computer language, in any form or by any means, electronic, mechanical, magnetic, optical, chemical, manual or otherwise, without the prior written permission of Acer Incorporated.

Disclaimer

The information in this guide is subject to change without notice.

Acer Incorporated makes no representations or warranties, either expressed or implied, with respect to the contents hereof and specifically disclaims any warranties of merchantability or fitness for any particular purpose. Any Acer Incorporated software described in this manual is sold or licensed "as is". Should the programs prove defective following their purchase, the buyer (and not Acer Incorporated, its distributor, or its dealer) assumes the entire cost of all necessary servicing, repair, and any incidental or consequential damages resulting from any defect in the software.

Acer is a registered trademark of Acer Corporation.

Intel is a registered trademark of Intel Corporation.

Pentium and Pentium II/III are trademarks of Intel Corporation.

Other brand and product names are trademarks and/or registered trademarks of their respective holders.

Conventions

The following conventions are used in this manual:

Screen messages	Denotes actual messages that appear on screen.
NOTE	Gives bits and pieces of additional information related to the current topic.
WARNING	Alerts you to any damage that might result from doing or not doing specific actions.
CAUTION	Gives precautionary measures to avoid possible hardware or software problems.
IMPORTANT	Reminds you to do specific actions relevant to the accomplishment of procedures.

Preface

Before using this information and the product it supports, please read the following general information.

1. This Service Guide provides you with all technical information relating to the BASIC CONFIGURATION decided for Acer's "global" product offering. To better fit local market requirements and enhance product competitiveness, your regional office MAY have decided to extend the functionality of a machine (e.g. add-on card, modem, or extra memory capability). These LOCALIZED FEATURES will NOT be covered in this generic service guide. In such cases, please contact your regional offices or the responsible personnel/channel to provide you with further technical details.
2. Please note WHEN ORDERING FRU PARTS, that you should check the most up-to-date information available on your regional web or channel. If, for whatever reason, a part number change is made, it will not be noted in the printed Service Guide. For ACER-AUTHORIZED SERVICE PROVIDERS, your Acer office may have a DIFFERENT part number code to those given in the FRU list of this printed Service Guide. You MUST use the list provided by your regional Acer office to order FRU parts for repair and service of customer machines.

Chapter 1	System Introduction	1
	Features	1
	System Block Diagram	3
	Board Layout	4
	Top View	4
	Bottom View	5
	Panel	6
	Front Panel	6
	Left Panel	7
	Right Panel	8
	Rear Panel	9
	Bottom Panel	10
	Indicators	11
	Keyboard	13
	Special keys	13
	Hot Keys	15
	Hardware Specifications and Configurations	19
	BIOS Setup Utility	34
Chapter 2	System Utilities	34
	Multi-Boot Menu	35
	Navigating the BIOS Utility	36
	System Information	37
	Main System Settings	39
	Advanced Information	41
	Primary Master	42
	Secondary Master	43
	PCI IRQ Routing	44
	System Security	45
	Boot Options	48
	Exit Setup	49
	BIOS Flash Utility	50
	Executing the PHFlash Program	50
	Executing the WFlash Program	50
	System Utility Diskette	51
Chapter 3	Machine Disassembly and Replacement	52
	General Information	53
	Before You Begin	53
	Disassembly Procedure Flowchart	54
	Removing the Battery Pack	56
	Disassembling the Battery Pack	56
	Removing the Optical Drive Module	57
	Removing the Hard Disk Drive Module	58
	Disassembling the Hard Disk Drive Module	58
	Removing the Memory Module	59
	Removing the Modem Board	60
	Disassembling the LCD	61
	Removing the Middle Cover	61
	Removing the Launch Board	61
	Removing the Keyboard	62
	Removing the LCD Module	62
	Removing the LCD Bezel	63
	Removing the Inverter Board	64

Table of Contents

Removing the LCD	.65
Removing the LCD Hinges	.65
Removing the LCD Coaxial Cable	.66
Disassembling the Main Unit	.67
Removing the Keyboard Bracket	.67
Removing the DC Charger Plate	.67
Removing the RTC Battery	.67
Removing the Touch Pad Frame	.68
Removing the DC to DC Board	.68
Removing the CPU Fan Sink	.69
Removing the Processor	.69
Installing the Processor	.69
Removing the Upper Case	.70
Removing the Touch Pad Board	.71
Removing the Touch Pad Button	.71
Removing the Touch Pad Scroll Key	.72
Removing the Touch Pad FPC	.72
Removing the VGA Thermal Plate	.73
Removing the Floppy Disk Drive Module	.73
Removing the Speakers	.75
Removing the Main Board	.76
Removing the PCMCIA Slot	.77
Removing the I/O Port Bracket	.78
Chapter 4 Troubleshooting	80
System Check Procedures	.81
External Diskette Drive Check	.81
External CD-ROM Drive Check	.81
Keyboard or Auxiliary Input Device Check	.82
Memory Check	.82
Power System Check	.82
Touchpad Check	.84
Power-On Self-Test (POST) Error Message	.85
Index of Error Messages	.86
POST Codes	.89
Index of Symptom-to-FRU Error Message	.93
Intermittent Problems	.96
Undetermined Problems	.97
Index of Phlash16 Error Message	.98
Index of PQA Diagnostic Error Code, Message	.100
Chapter 5 Jumper and Connector Locations	102
Top View	.102
Bottom View	.104
CN27 Jumper Settings	.105
Chapter 6 FRU (Field Replaceable Unit) List	106
Exploded Diagram	.107
Appendix A Model Definition and Configuration	118
Model Number Definition	.118
Appendix B Test Compatible Components	120
Microsoft Windows XP Environment Test	.121

System Introduction

Features

This computer was designed with the user in mind. Here are just a few of its many features:

Performance

- Intel® Pentium® 4/ Northwood socket P478 up to 3.2GHz processor with 512KB cache, supporting variable clock design.
- 64-bit memory bus
- Two 200-pin DDR-DRAM with each supporting 128MB/ 256MB/ 512MB, upgradable to the total maximum of 1GB with SODIMM modules, supporting 2100.
- Built-in floppy diskette drive and Hard diskette drive
- High-capacity, Enhanced-IDE hard disk
- Simultaneous LCD and CRT display
- Smart Lithium-Ion battery pack with maximum 1.5 hours battery life
- Power management system with ACPI (Advanced Configuration Power Interface)

Multimedia

- 16-bit high-fidelity AC'97 stereo audio with 3D sound and wavetable synthesizer
- Built-in dual speakers
- High-speed CD-ROM, DVD-ROM, or DVD/ CD-R/RW drive

Connectivity

- 84/85/88 key keyboard, which is PC/AT keyboard compatible.
- Four Universal Serial Bus (USB) 2.0 Ports
- One IEEE 1394 port
- Built-in V.92 RJ-11 56Kbps fax/modem
- Onboard 10/100 Mbps Ethernet LAN Support
- Upgradeable memory and hard disk

Multimedia

- All-in-one design (CD-ROM, floppy disk drive, hard disk drive)
- Sleek, smooth and stylish design
- Full-sized keyboard
- Ergonomically centered touchpad pointing device with Internet scroll key

Expansion

- Two CardBus PC Card (formerly PCMCIA) Type II slot.
- Upgradeable memory and hard disk

I/O Ports

- One VGA port
- One DC-in port (AC adapter)
- Dual high quality stereo speakers

-
- One microphone in (share with line-in)
 - One line-out
 - Two CardBus type II slot (3.3V, 5V support)
 - Four USB ports
 - One IEEE 1394 port
 - One RJ-11 port
 - One RJ-45 jack
 - One TV out

Display

- 15" TFT LCD displaying 32-bit true-color at 1024x768 XGA resolution.
- 3D capabilities
- Supports other output display devices such as LCD projection panels for large audience presentations
- "Automatic LCD dim" feature that automatically decides the best settings for your display and conserves power is activated when the system operates in Battery condition.

Video performance

4X AGP UMA video graphic accelerator with 64MB shared from system memory with Intel SiS648FX to boost the video performance.

Simultaneous display

The computer's large display and multimedia capabilities are great for giving presentations. If you prefer, you can also connect an external monitor when giving presentations. This computer has built-in AGP and VGA display system to support simultaneous LCD and CRT display. Simultaneous display allows you to control the presentation from your computer and at the same time face your audience. You can also connect other output display devices such as LCD projection panels for large-audience presentations.

Power management

The power management system incorporates an "automatic LCD dim" feature that automatically dims the LCD when the computer is powered by a battery pack to conserve battery power. See "Power Management" on page 29 for more information on power management features.

Opening and closing the display

To open the display, slide the display cover latch to the right and lift up the cover. Then tilt it to a comfortable viewing position. The computer employs a microswitch that turns off the display (and enters standby mode) to conserve power when you close the display cover, and turns it back on when you open the display cover.

WARNING: To avoid damaging the display, do not slam it when you close it. Also, do not place any object on top of the computer when the display is closed.

System Block Diagram

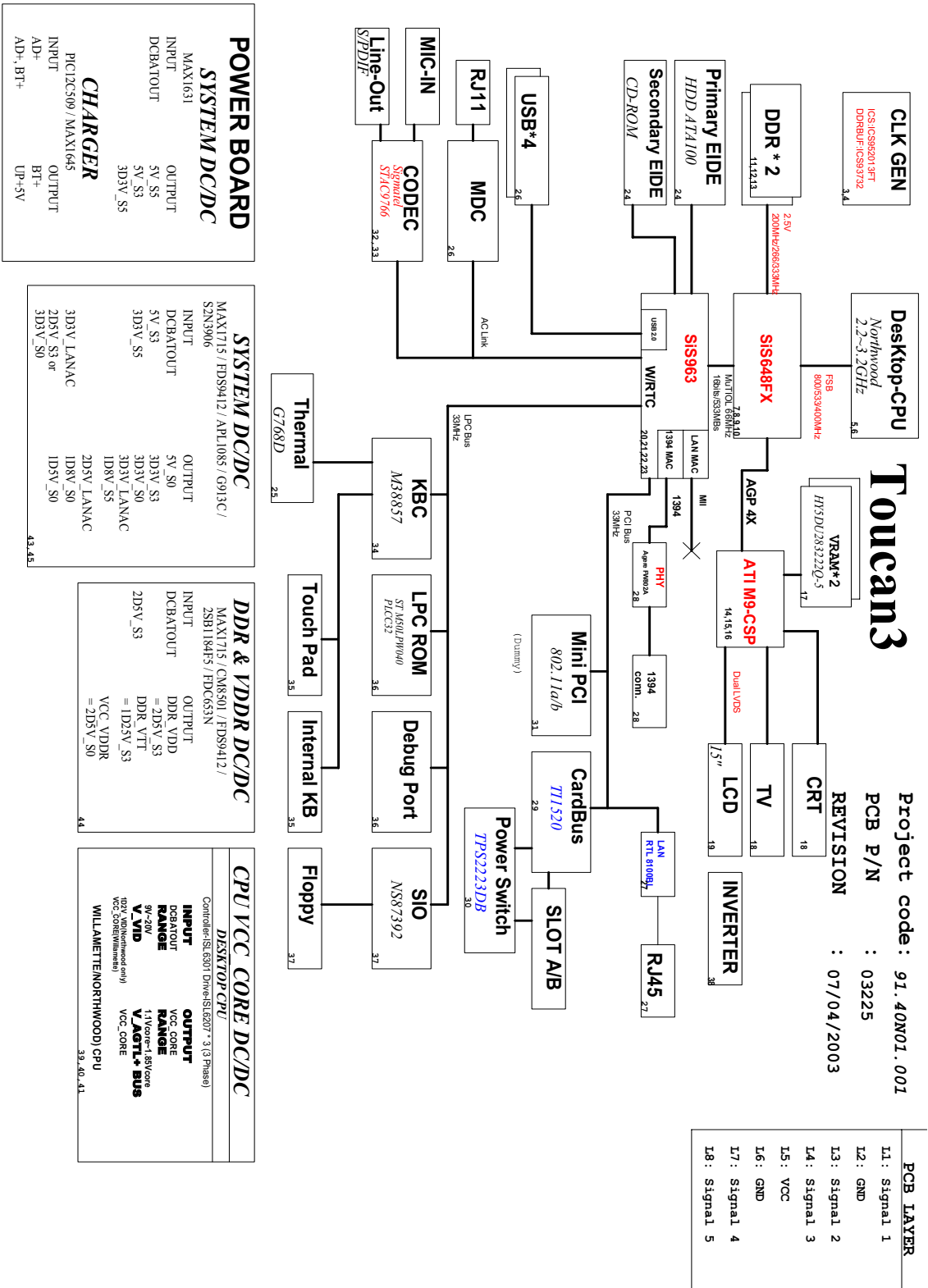

Board Layout

Top View

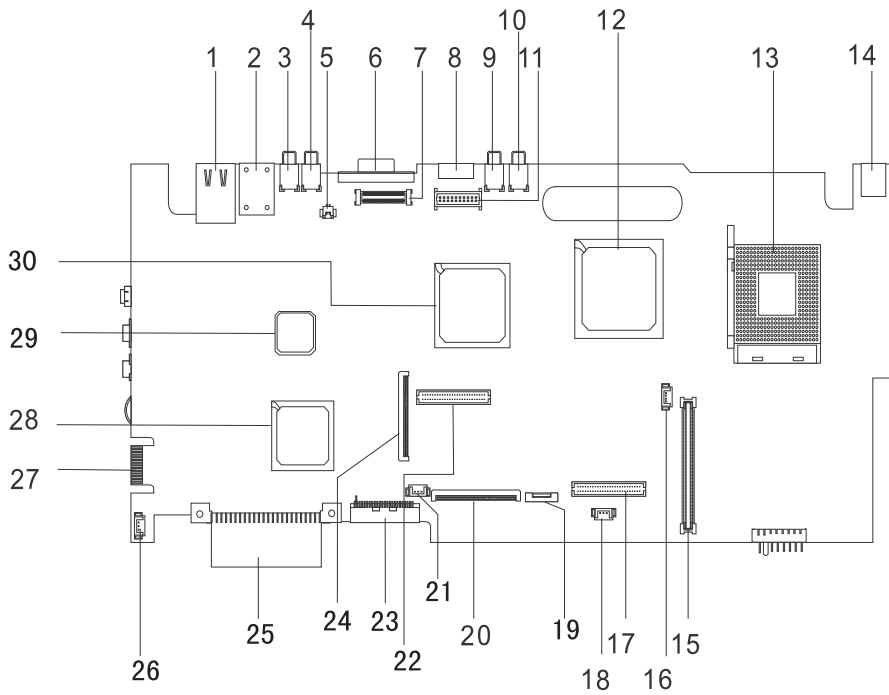

PCB No. 03225-1

1	LAN Port	16	Fan Connector
2	Modem Port	17	DC to DC Connector
3	USB Port	18	RTC Connector
4	USB Port	19	Touchpad Connector
5	Launch board cable connector	20	Keyboard Connector
6	VGA Port	21	Fan Connector
7	LCD Monitor Connector	22	DC to DC Connector
8	S-Video Connector	23	Secondary IDE Connector
9	USB Port	24	Floppy Diskette Drive Connector
10	USB Port	25	Primary IDE Connector
11	Inverter Connector	26	Speaker Connector
12	SiS648FX	27	Debug Board (Golden Finger)
13	CPU Socket	28	SiS963 (South Bridge)
14	DC-in Port	29	Super IO Controller (PC87392V JG)
15	Cardbus Connector	30	VGA Chip (Radeon 9000)

Bottom View

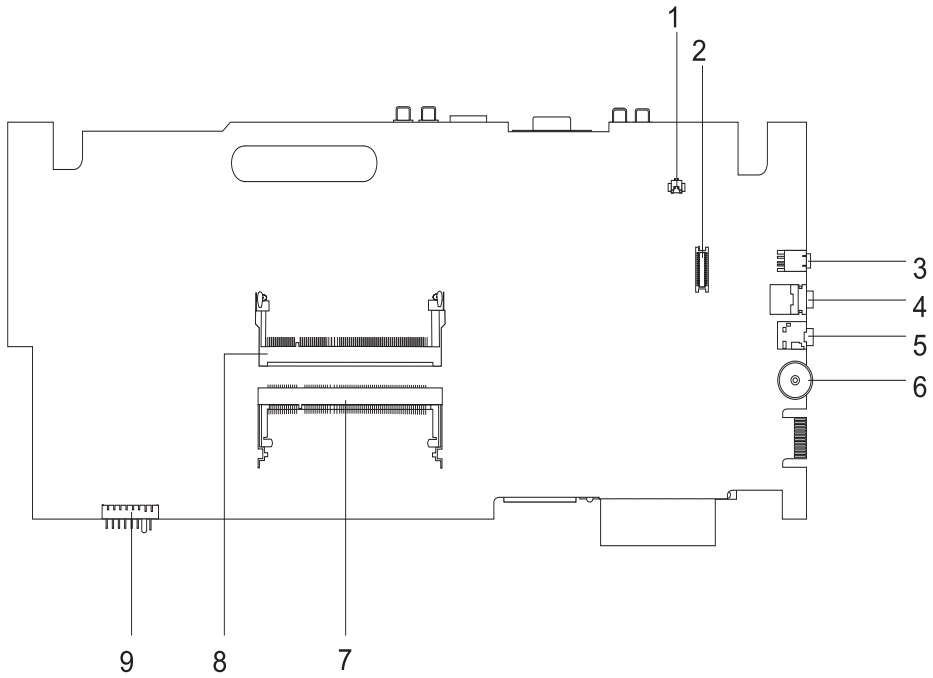



- | | | | |
|---|-----------------------|---|-------------------|
| 1 | Modem Cable Connector | 6 | Volume Controller |
| 2 | Modem Connector | 7 | Memory Slot 2 |
| 3 | IEEE 1394 Port | 8 | Memory Slot 1 |
| 4 | Speaker out Port | 9 | Battery Connector |
| 5 | Line-in Port | | |

Panel

Ports allow you to connect peripheral devices to your computer as you would with a desktop PC.

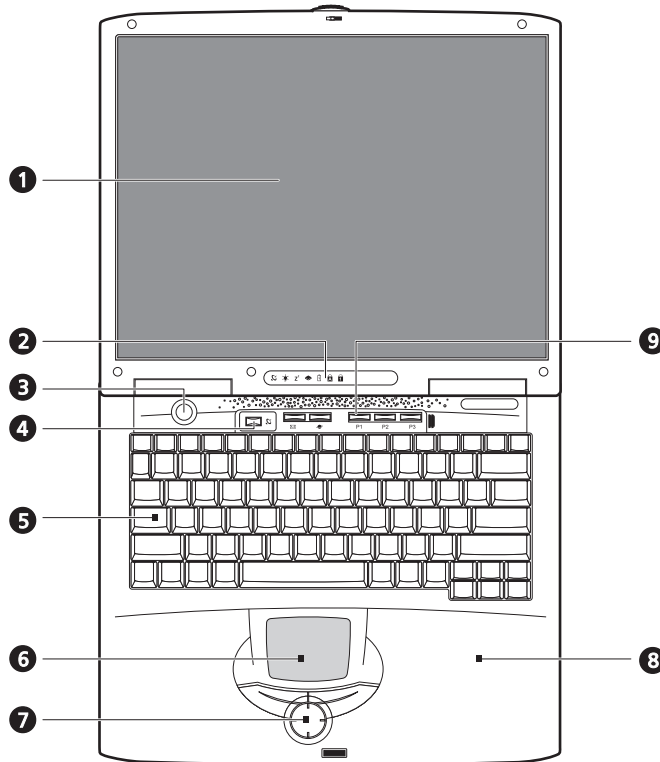



Front Panel

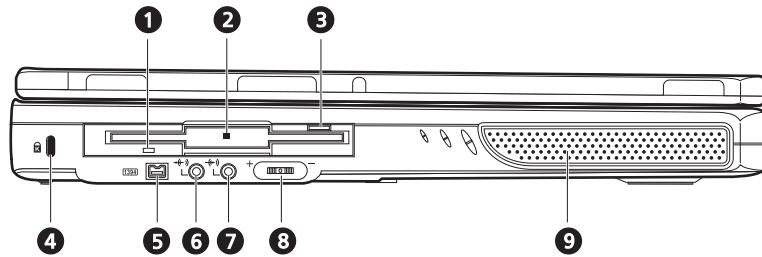

#	Icon	Item	Description
1		Display screen	Also called LCD (Liquid Crystal Display), displays computer output.
2		Status indicators	LEDs (Light Emitting Diodes) that turn on and off to show the status of the computer and its functions and components.
3		Power button	Turns off the computer power.
5		Keyboard	Inputs data into your computer.
6		Touchpad	Touch-sensitive pointing device which functions like a computer mouse.
7		Click button (left, center and right)	The left and right buttons function like the left and right mouse buttons, the center button serves as a scroll up/down button.
8		Palmrest	Comfortable support area for your hands when you use the computer.
9		Easy launch keys	Buttons for launching frequently used programs.

Left Panel



#	Icon	Item/ Port	Description
1		Floppy activity indicator	LED (light-emitting diodes) that turn on and off when the floppy is active.
2		Floppy drive	Internal diskette drive, accepts 3.5-inch floppy diskettes.
3		Floppy disk eject button	Push this button to eject the floppy disk
4		Security keylock	Kensington-compatible key-based computer security lock.
5		IEEE 1394 port	Connects to a IEEE 1394-compatible device (e.g., digital video camera).
6		Line-out jack	Connects to audio line-out devices (e.g., speakers, headphones)
7		Line-in jack	Connects an external microphone or an external audio line-in devices.
8		Volume control knob	Controls the volume of the speakers.
9		Speaker (Left)	Outputs sound

Right Panel

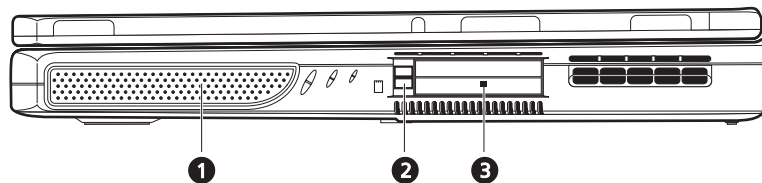

#	Icon	Item/ Port	Description
1		Speaker (Right)	Outputs sound.
2		PC Card eject button	Eject the PC Card from its slot.
3		PCMCIA (PC card) Port	Connects to two Type II 16-bit PC card or 32-bit CardBus PC Card.



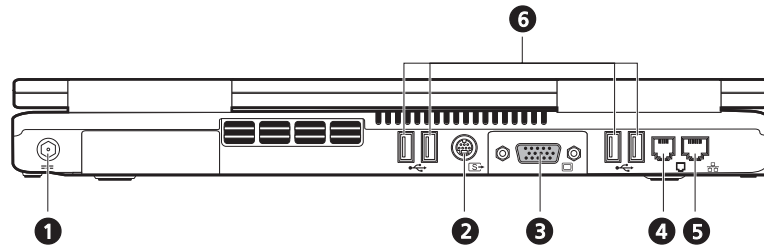



Rear Panel

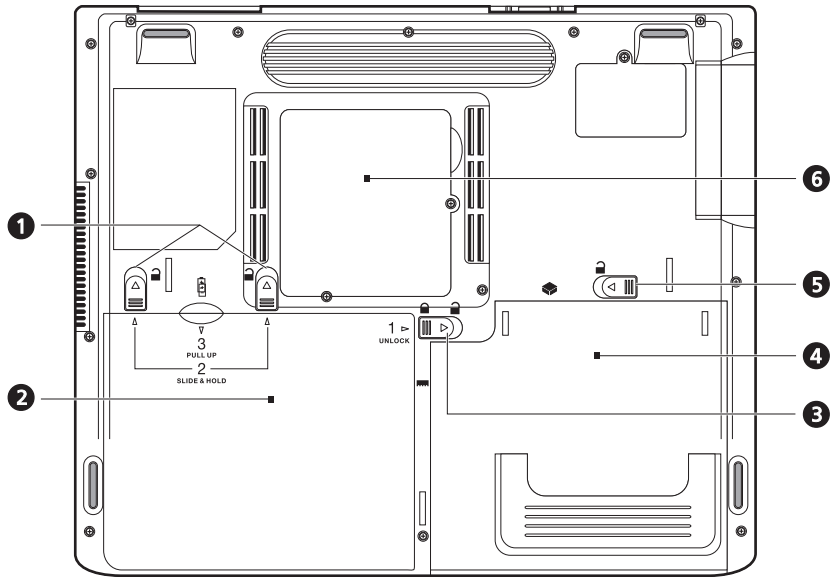

#	Icon	Port	Description
1		Power jack	Connects to an AC adapter.
2		Video-out port	Connects to a display device with S-video input.
3		External monitor port	Connects to a display device e.g., external monitor, LCD projector) and displays up to 64K colors at 2048x1536 resolution.
4		Modem jack	Connects to the phone line.
5		Network jack	Connects to an Ethernet 10/100-based network
6		USB port (Four)	Connects to any Universal Serial Bus devices(e.g., USB mouse, USB camera).

Bottom Panel







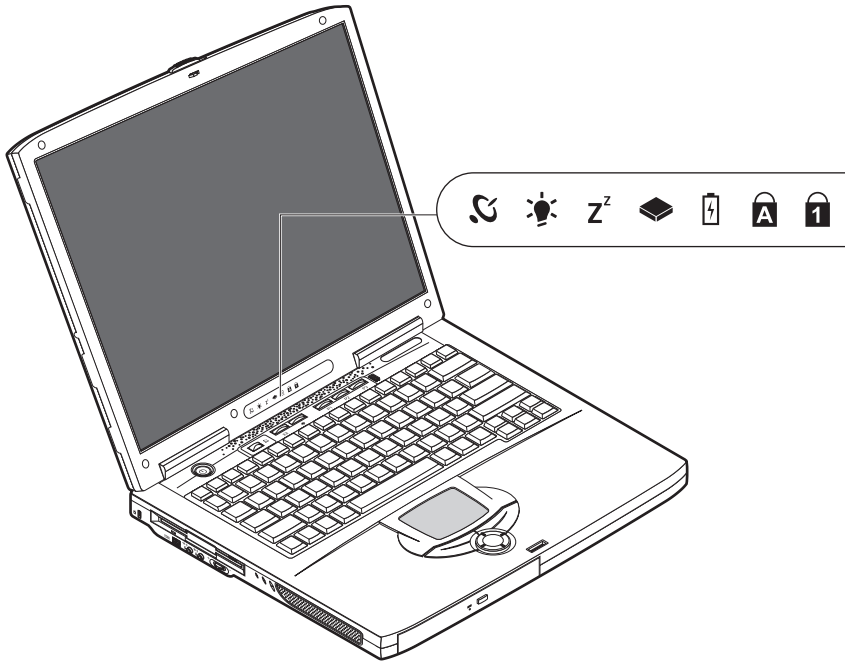

#		Item	Description
1		Battery release latches	Unlatches the battery to remove the battery pack.
2		Battery bay	Houses the computer's battery pack.
3	 	Battery lock	Locks/unlocks the battery pack in the battery bay.
4		Media bay module	Installed in the media bay. Provide the optical media access or secondary storage by way of removable modules.
5		Media bay release latch	Unlatches the media bay module.
6		Memory compartment	Houses the computer's main memory.

Indicators

The computer has seven easy-to-read status icons on the right of the display screen.



The Power and Standby status icons are visible even when you close the display cover so you can see the status of the computer while the cover is closed.

#	Icon	Function	Description
1		Wireless LAN	This button is used to enable or disable the wireless LAN (optional) function
2		Power	Lights when the computer is on.
3		Sleep	Lights when the computer enters Standby mode and blinks when it enters into or resumes from hibernation mode.
4		Media Activity	Lights when the floppy drive, hard disk or Media drive is active.
5		Battery Charge	Lights when the battery is being charged.
6		Caps Lock	Lights when Caps Lock is activated.

#	Icon	Function	Description
7		Num Lock (Fn-F11)	Lights when Numeric Lock is activated.

Keyboard





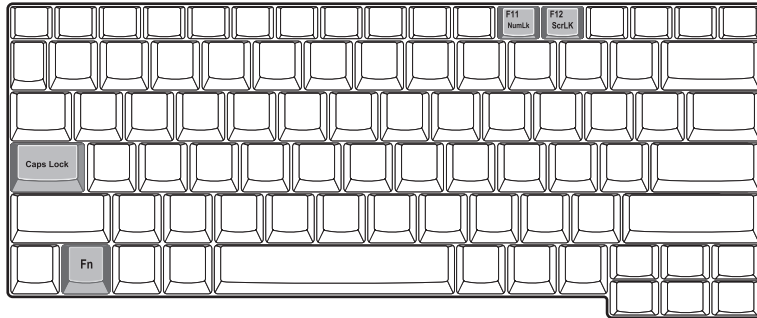

The keyboard has full-sized keys and an embedded keypad, separate cursor keys, two Windows keys and twelve function keys.

Special keys

Lock keys

The keyboard has three lock keys which you can toggle on and off.



Lock key	Description
Caps Lock 	When  is on, all alphabetic characters typed are in uppercase.
Num Lock (Fn-F11) 	When  is on, the embedded keypad is in numeric mode. The keys function as a calculator (complete with the arithmetic operators \cdot , $-$, $*$, and $/$). Use this mode when you need to do a lot of numeric data entry. A better solution would be to connect an external keypad.
Scroll Lock (Fn-F12) 	When  is on, the screen moves one line up or down when you press the up or down arrow keys respectively.  does not work with some applications.

Embedded numeric keypad

The embedded numeric keypad functions like a desktop numeric keypad. It is indicated by small characters located on the upper right corner of the keycaps. To simplify the keyboard legend, cursor-control key symbols are not printed on the keys.

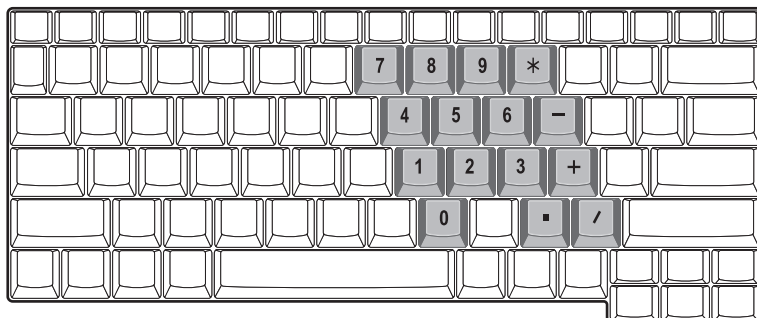









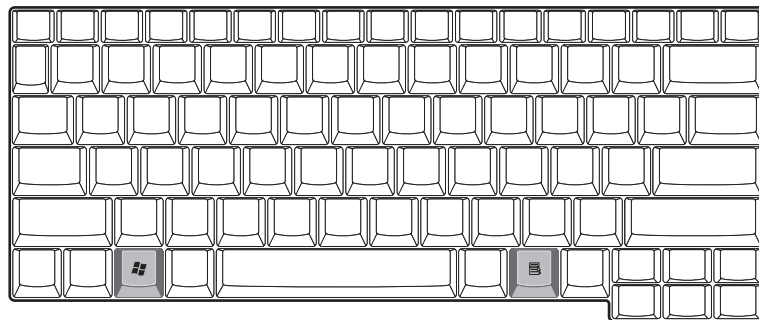

Desired access	Num lock on	Num lock off
Number keys on embedded keypad	Type numbers in a normal manner.	
Cursor-control keys on embedded keypad	Hold Shift while using cursor-control keys.	Hold Fn while using cursor-control keys.
Main keyboard keys	Hold Fn while typing letters on embedded keypad.	Type the letters in a normal manner.

NOTE: If an external keyboard or keypad is connected to the computer, the Num Lock feature automatically shifts from the internal keyboard to the external keyboard or keypad.

Windows keys

The keyboard has two keys that perform Windows-specific functions.



Keys	Description
Windows logo key 	Start button. Combinations with this key perform shortcut functions. Below are a few examples:  + Tab (Activates next taskbar button)  + E (Explores My Computer)  + F (Finds Document)  + M (Minimizes All)  +  + M (Undoes Minimize All)  + R (Displays the Run... dialog box)
Application key 	Opens a context menu (same as a right-click).





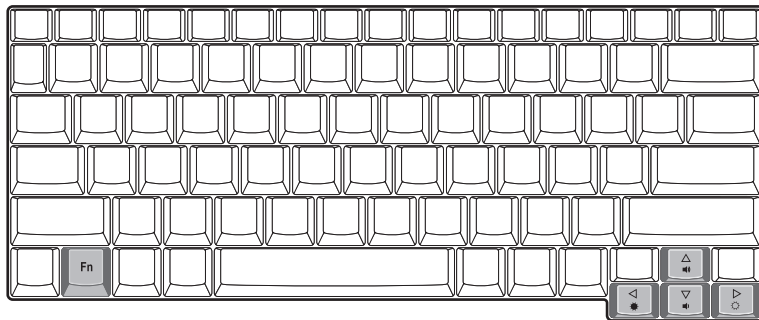
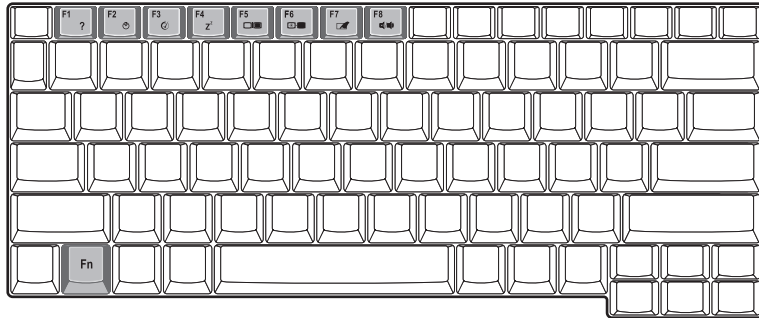

Hot Keys

The computer employs hot keys or key combinations to access most of the computer's controls like screen contrast and brightness, volume output and the BIOS Utility.

To activate hot keys, press and hold the **Fn** key before pressing the other key in the hot key combination.



Hot Key	Icon	Function	Description
Fn-F1	?	Hotkey help	Displays a list of the hotkeys and their functions.
Fn-F2	⚙️	Setup	Accesses the notebook configuration utility.
Fn-F3	🔋	Power Scheme Toggle	Switches between the power management scheme used by the computer (function available if supported by operating system).
Fn-F4	Z ^Z	Sleep	Puts the computer in Sleep mode.
Fn-F5	🖥️	Display toggle	Switches display output between the display screen, external monitor (if connected) and both the display screen and external monitor.
Fn-F6	☀️	Screen blank	Turns the display screen backlight off to save power. Press any key to return.

Hot Key	Icon	Function	Description
Fn-F7		Touchpad Toggle	Turns the internal touchpad on and off.
Fn-F8		Speaker on/off	Turns the speakers on and off; mutes the sound.
Fn-↑		Contrast up	Increases the screen contrast (available only for models with HPA displays).
Fn-↓		Contrast down	Decreases the screen contrast (available only for models with HPA displays).
Fn-→		Brightness up	Increases the screen brightness.
Fn-←		Brightness down	Decreases the screen brightness.
ALT Gr-Euro		Euro	Types the Euro symbol.

The Euro symbol

If your keyboard layout is set to United States-International or United Kingdom or if you have a keyboard with a European layout, you can type the Euro symbol on your keyboard.

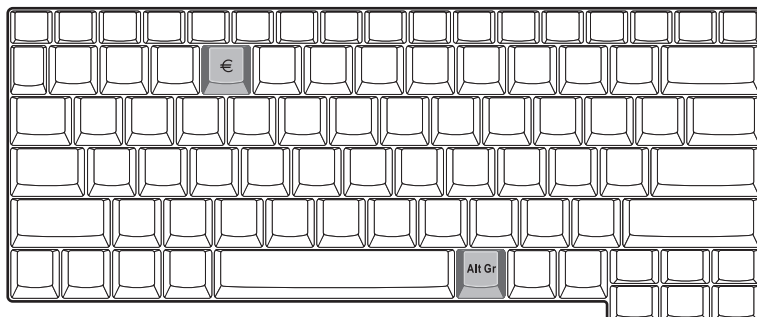

NOTE: for US keyboard users: The keyboard layout is set when you first set up Windows. For the Euro symbol to work, the keyboard layout has to be set to United States-international.

To verify the keyboard type:

1. Click on **Start, Control Panel**.
2. Double-click on **Regional and Language Options**.
3. Click on the **language** tab and click on **Details**.
4. Verify that the keyboard layout used for "EN English (United States) is set to United States-International. If not, select and click on **ADD**, then select **United States-International** and click on **OK**.
5. Click on **OK**.



To type the Euro symbol:

1. Locate the Euro symbol on your keyboard.
2. Open a text editor or word processor.
3. Hold **ALT** Gr and press the Euro symbol.

Launch Keys

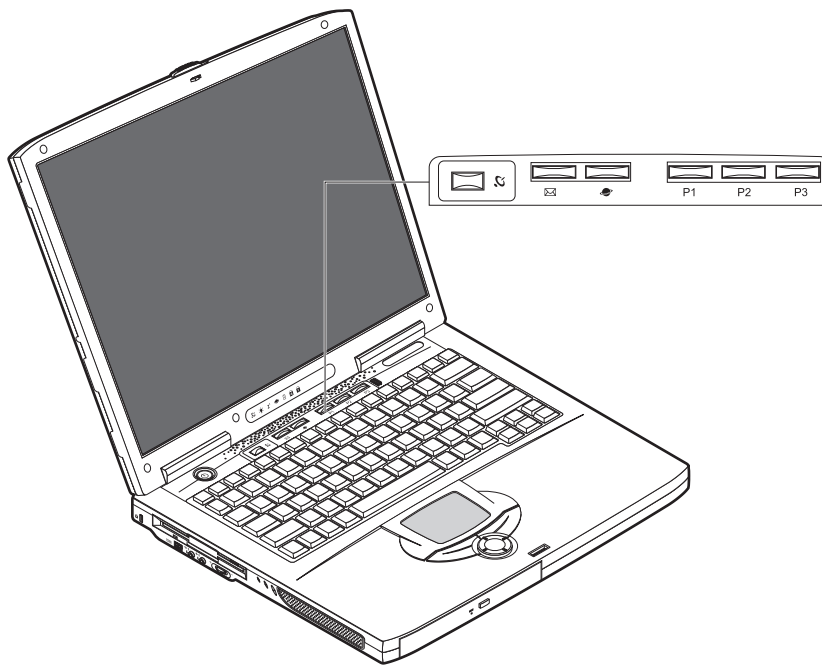
Located at the top of the keyboard are six buttons. These buttons are called launch keys. They are designated as wireless LAN, Web Browser button, mail button, P1, P2 and P3. By default, P1, P2 and P3 are users programmable. The Web Browser button, by default, is used to launch the internet browser. The mail button is used to launch the e-mail application. The LED of the mail button will flash when the user has received an incoming email.



#	Icon	Function	Description
1		Mail	Email application
2		Web browser	Internet browser application

#	Icon	Function	Description
3	P1	P1	User-programmable
4	P2	P2	User-programmable
5	P3	P3	User-programmable

Hardware Specifications and Configurations

System Board Major Chips

Item	Controller
System core logic	SiS648FX
Super I/O controller	NS87392
Audio controller	Codec Sigmatel STAC9766
Video controller	ATI M9CSP
Hard disk drive controller	ATA100
Keyboard controller	Mitsubishi M38857
CardBus Controller	TI 1520
RTC	SiS645DX

Processor

Item	Specification
CPU type	Desktop CPU 3.2GHz/FSB800
CPU package	3.2GHz uFCBGA
CPU core voltage	1.7V
CPU I/O voltage	1.25V

BIOS

Item	Specification
BIOS vendor	Phoenix BIOS
BIOS Version	R01-A0X
BIOS ROM type	Flash ROM
BIOS ROM size	512KB
BIOS package	32 Pin PLCC
Supported protocols	ACPI 2.0 (if available, at least 1.0b), PCI 2.2, INT 13h Extensions, PnP BIOS 1.0a, SMBIOS 2.3, Boot Block, USB Specification 1.1/2.0, DTMF Desktop Management Interface Specification V2.0, IEEE 1394 V1.0, WfM2.0 (for build-in Ethernet model), PCMCIA V3.0 Compliant device, Mobile PC2001 Compliant, EI Torito-Bootable CD-ROM Specification V1.0, Simple Boot Flag 1.0
BIOS password control	Set by switch, see SW1 settings

Second Level Cache

Item	Specification
Cache controller	Built-in CPU
Cache size	512KB
1st level cache control	Always Enabled
2nd level cache control	Always Enabled
Cache scheme control	Fixed-in write back

System Memory

Item	Specification
Memory controller	SiS648FX

System Memory

Item	Specification
Onboard memory size	0MB
DIMM socket number	2 Sockets
Supports memory size per socket	512MB
Supports maximum memory size	1024MB
Supports DIMM type	DDR-DRAM SODIMM
Supports DIMM Speed	266 MHz
Supports DIMM voltage	3.3 V
Supports DIMM package	200-pin so-DIMM
Memory module combinations	You can install memory modules in any combinations as long as they match the above specifications .

Memory Combinations

Slot 1	Slot 2	Total Memory
0MB	128MB	128 MB
128MB	0MB	128 MB
128MB	128MB	256 MB
256MB	0MB	256MB
0MB	256MB	256MB
256MB	128MB	384MB
128MB	256MB	384MB
256MB	256MB	512MB
0MB	512MB	512MB
512MB	128MB	640MB
256MB	512MB	768MB
128MB	512MB	640MB
512MB	256MB	768MB
512MB	512MB	1024MB
512MB	0MB	512MB
1024MB	0MB	1024MB
1024MB	128MB	1152MB
1024MB	256MB	1280MB
1024MB	512MB	1536MB
1024MB	1024MB	2048MB

Above table lists some system memory configurations. You may combine DIMMs with various capacities to form other combinations.

Modem Interface

Item	Specification
Chipset	Ambit MDC module with Lucent modem controller
Fax modem data baud rate (bps)	14.4K
Data modem data baud rate (bps)	56K
Supports modem protocol	V.92 MDC
Modem connector type	RJ11
Modem connector location	Rear side

Floppy Disk Drive Interface

Item	Specification		
Vendor & model name	MCI JU-226A033		
Floppy Disk Specifications			
Media recognition	2DD (720KB)	2HD (1.2 MB, 3 mode)	2HD (1.44MB)
Sectors/track	9	15	18
Tracks	160	154(160)	160
Cylinders	80	76(80)	80
Data transfer rate (Kbit/s)	1 MB	1.6 MB	2 MB
Rotational speed (RPM)	300	360	300
Read/write heads	2		
Encoding method	MFM		
Power Requirement			
Input Voltage (V)	+5V		

Hard Disk Drive Interface

Item	Specification		
Vendor & Model Name	Fujitsu HN-16L		Hitachi DK23EA-60/40
Capacity (MB)	40000	60000/30000	40000
Bytes per sector	512		512
Logical heads	16		16
Logical sectors	63		63
Drive Format			
Logical cylinders	16383		16383
Physical read/write heads	3	4/2	3(DK23EA-40) 2(DK23EA-30/20) 4(DK23EA-60)
Disks	2	2/1	2(DK23EA-60/40) 1(DK23EA-30/20)
Spindle speed (RPM)	4200RPM		4200RPM
Performance Specifications			
Buffer size	2MB		2MB
Interface	ATA-6		ATA-5 (IDE)
Data transfer rate (disk-buffer, Mbytes/s)	18.1-33.8	19.4-38.1	121-216

Hard Disk Drive Interface

Item	Specification	
Data transfer, rate (host~buffer, Mbytes/s)	100 MB/Sec	Max. 100 MB/Sec (Ultra DMA Mode 5) Max. (16.6 PIO Mode 4/ Multiword DMA Mode 2)
DC Power Requirements		
Voltage tolerance	5 +/- 5%	5 +/- 5%

DVD-RW Interface

Item	Specification	
Vendor & model name	PANASONIC UJ-811B	
Performance Specification	With CD Diskette	With DVD Diskette
Transfer rate (KB/sec)	Average Sustained: CAV mode 775~1800 blocks/sec (10.3X to 24X) 1550~3600kBytes/sec (Mode 1) 1768~4106 kBytes/sec (Mode 2)	DVD-5: Normal Speed (1X) 11.08 Mbits/sec CAV mode 36.67~88.64 Mbits/sec DVD-9/DVD-R/DVD-RW: Normal Speed (1X) 11.08 Mbits/sec CAV mode 36.67~88.64 Mbits/sec

DVD-RW Interface

Item	Specification	
Average Full Access time (typ.)	CD: (Disc: MNSU-005) Random (*1) CAV mode 95 msec typical 125 msec average max Full Stroke (*2) CAV mode 200 msec typical 260 msec average max 1/3 Stroke (*3) CAV mode 105 msec typical 135 msec average max	DVD-5:(Disc: MKE-D551) Random (*4) 120 msec typical 160 msec average max Full Stroke (*5) 270 msec typical 350 msec average max 1/3 Stroke (*6) 130 msec typical 170 msec average max DVD-9: (Disc: ODSC-PARA) Random (*7) 150 msec typical 200 msec average max Full Stroke (*8) 340 msec typical 450 msec average max 1/3 Stroke (*9) 170 msec typical 220 msec average max DVD-RAM (2.6G) (Disc: LM-DB26) Random (*10) 200 msec typical 300 msec average max Full Stroke (*11) 300 msec typical 600 msec average max Full Stroke (*12) 220 msec typical 320 msec average max DVD-RAM (4.7G) (Disc: LM-HB47J) Random (*13) 180 msec typical 300 msec average max Full Stroke (*14) 320 msec typical 700 msec average max Full Stroke (*15) 240 msec typical 350 msec average max
Data Buffer Capacity	256 kBytes	
Interface	IDE	
Applicable disc format	DVD: DVD-5, DVD-9, DVD-10, DVD-18, DVD-R (3.95G/4.7G), DVD-RAM (2.6G/4.7G), DVD-RW CD: CD-Audio, CD-ROM (mode 1 and mode 2), CD-ROM XA (mode 2, form 1 and form 2), CD-I (mode 2, form 1 and form 2), CD-I Ready, CD-I Bridge, CD-WO, CD-RW, Photo CD, Video CD, Enhanced Music CD, CD-TEXT	
Loading mechanism	Soft eject (with emergency eject hole)	
Power Requirement		
Input Voltage	+5V[DC]±5%	

(*1) Average of Data read over the whole area from 00 min. 02 sec. 00 block to 59 min. 58 sec. 74 block more than 2000 times including latency and layered error correction time.

(*2) From 00 min. 02 sec. 00 block to 59 min. 58 sec. 74 block including latency and layered error correction time.

(*3) From 00 min. 02 sec. 00 block to 20 min 00 sec. 00 block including latency and layered error correction time.

(*4) Average of Data read over the whole area from starting data recorded area (LBA:0) to maximum data recorded area (LBA:23197F), more than 2000 times including latency and layered error correction time.

(*5) From starting data recorded area (LBA:0) to maximum data recorded area (LBA:23197F) including latency and layered error correction time.

(*6) From starting data recorded area (LBA:0) to maximum data recorded area (LBA:86A29) including latency and layered error correction time.

(*7) Average of Data read over the whole area from starting data recorded area (LBA:0) to maximum data recorded area (LBA:3FA0DF), more than 2000 times including latency and layered error correction time.

(*8) From starting data recorded area (LBA:0) to maximum data recorded area (LBA:3FA0DF) including latency and layered error correction time.

(*9) From starting data recorded area (LBA:0) to maximum data recorded area (LBA:277D8E) including latency and layered error correction time.

Combo Drive Interface

Item	Specification
Vendor & model name	Panasonic JUDA750WS-A
Performance Specification	
Transfer rate (KB/sec)	Read Sustained: DVD-ROM MAX 8X CAV (MAX 10800 KB/sec) CD-ROM MAX 24X CAV (MAX 3600 KB/sec) Write: CD-R 4X, 8X (CLV), MAX. 16X, MAX. 24X Zone (ZCLV) CD-RW 4X (CLV) HS-RW 4X, 8X, 10X (CLV) ATAPI Interface: PIO mode 16.6 MB/sec :PIO Mode 4 DMA mode 16.6 MB/sec:Multi word mode 2 Ultra DMA mode 33.3MB/sec: Ultra DMA mode 2
Error Rate	CD-ROM (with ECC) Less than 10^{-12} bit (without ECC) Less than 10^{-9} bit DVD-ROM Less than 10^{-12} bit
Buffer rate	2MB
Access time	DVD-ROM 180 ms typ. (1/3 stroke) CD-ROM 130 ms typ. (1/3 stroke)
Start up time	less than 15s
Stop time	less than 6s
Acoustic noise	less than 50 dBA
Interface	Enhanced IDE (ATAPI) compatible
Master/Slave	Set by Cable Select (By host)
Regional Code	"NONE"
PC compatible	PC2001 compatible
Applicable disc format	CD: CD-DA, CD-ROM, CD-ROM XA, CD-R, CD-RW, PhotoCD (multiSession), Video CD, CD-Extra(CD+), CD-text DVD: DVD-ROM, DVD-R, DVD-RW (Ver.1.1)
Slope	15 degree (Any direction)
Dimensions, Weight	128X129X12.7mm (WXDXH) (except protrusion) 200g+- 10g

Combo Drive Interface

Item	Specification
Eject	Soft Eject (with emergency eject hole)

Audio Interface

Item	Specification
Audio Controller	Sigmatel STAC9766
Audio onboard or optional	Built-in
Mono or Stereo	Stereo
Resolution	20 bit stereo Digital to Analog converter 18 bit stereo Analog to Digital converter
Compatibility	Microsoft PC98/PC99, AC97 2.2
Mixed sound source	CD, Mic-in, Phone, PC Speaker
Voice channel	8/16 bit, mono/stereo
Sampling rate	44.1 KHz
Internal microphone	No
Internal speaker / Quantity	Yes/2
Supports PnP DMA channel	DMA channel 0 DMA channel 1
Supports PnP IRQ	IRQ18

Video Interface

Item	Specification
Vendor & Model Name	ATI M9CSP
Chip voltage	Core / 2.5V, 1.5V, 1.8V
Supports ZV (Zoomed Video) port	NO
Graph interface	4X AGP (Accelerated Graphic Port) Bus
Maximum resolution (LCD)	XGA: 1024 x768 (32bit colors)
Maximum resolution (CRT)	2048x1536 (32 bit colors)

Video Memory

Item	Specification
Fixed or upgradeable	Fixed, share the system memory
Video memory size	64MB

Video Resolutions Mode

Resolution	Refresh Rate	
	CRT Only	LCD/CRT Simultaneous(Under the condition when using one controller)
640x480x256	85	60
640x480x64K	85	60
640x480x16M	85	60
800x600x256	85	60
800x600x64K	85	60
800x600x256	85	60

USB Port

Item	Specification
USB Compliance Level	2.0
OHCI	USB 2.0
Number of USB port	4
Location	Rear side
Serial port function control	Enable/Disable by BIOS Setup

PCMCIA Port

Item	Specification
PCMCIA controller	TI 1520
Supports card type	Type II
Number of slots	Two type II
Access location	Right side
Supports ZV (Zoomed Video) port	Yes
Supports 32 bit CardBus	Yes (IRQ1, IRQ17)

Keyboard

Item	Specification
Keyboard controller	Mitsubishi M38857
Keyboard vendor & model name	API
Total number of keypads	84-/85/88- key
Windows 95 keys	Yes
Internal & external keyboard work simultaneously	Yes

Battery

Item	Specification
Vendor & model name	SONY LIPX042ACPT (ET)
Battery Type	Li-ION
Pack capacity	5880mAH
Cell voltage	4.2V / 3.0V
Number of battery cell	12
Package configuration	12S
Package voltage	14.8V

DC-DC/Charger Converter

Item	Specification	
Vendor	Wistron	
Input Voltage	AC Adapter or Battery: 10V - 20VDC	
DC-DC Converter Output		
Output Rating	+5V	3.3V
Current (w/load, A)	0~5A	0~5A
Charger Output	Li-ION	

DC-DC/Charger Converter

Item	Specification
Normal charge (charge while system is not operative)	3.75A+/-0.375A
Background charge (charge even system is still operative)	0.8A
Protection	
Charger protection	Over Current Protection
DC/DC converter protection	OCP (Over Current Protection, 6A) OVP (Over Voltage Protection, 5.2~5.5V) UVP (Under Voltage Protection, 3~4V)
	OCP (Over Current Protection, 6A) OVP (Over Voltage Protection, 3.43~3.63V) UVP (Under Voltage Protection, 1.98~2.64V)

DC-AC LCD Inverter

Item	Specification
Vendor & model name	Ambit
Input voltage (V)	8 ~ 21V
Input current (mA)	1A (max.)
Output voltage (Vrms, no load)	1600Vrms
Output voltage frequency (kHz)	40 ~ 70KHz
Output Current/Lamp	5.5 mA ~ 6.0mA

NOTE: DC-AC inverter is used to generate very high AC voltage, then support to LCD CCFT backlight user, and is also responsible for the control of LCD brightness. Avoid touching the DC-AC inverter area while the system unit is turned on.

LCD

Item	Specification
Vendor & model name	15" AU B150XG01
Mechanical Specifications	
LCD display area (diagonal, inch)	15
Display technology	TFT
Resolution	XGA (1024x768)
Support colors	262K
Optical Specification	
Brightness control	Keyboard hotkey
Contrast control	None
Electrical Specification	
Supply voltage for LCD display (V)	3.3 (typ.)
Supply voltage for LCD backlight (Vrms)	700 (typ.)

AC Adapter

Item	Specification
Vendor & model name	PA-1121-02AW
Input Requirements	
Maximum input current (A, @90Vac, full load)	2A
Nominal frequency (Hz)	50-60
Frequency variation range (Hz)	47-63
Input voltage range (Vrms)	90-264
Inrush current	The maximum inrush current will be less than 50A and 100A when the adapter is connected to 115Vac and 230Vac respectively.
Efficiency	It should provide an efficiency of 83% minimum, when measured at maximum load under 115Vac.
Output Ratings (CV mode)	
DC output voltage	20V
Noise + Ripple	300mVp-pmax (20 MHz bandwidth)
Load	0(min) 6A(max)
Output Ratings (CC mode)	
DC output voltage	19.5V~21V for CV mode
Constant current mode	7.0 +/- 0.5A
Dynamic Output Characteristics	
Turn-on delay time	2 sec (@ 115Vac)
Hold up time	8ms (@115Vac, Full load)
Over Voltage Protection (OVP)	25V
Short circuit protection	The output can be shorted without damage
Electrostatic discharge (ESD)	15KV (at air discharge) 8KV (at contact discharge)
Dielectric Withstand Voltage	
Primary to secondary	1500Vac
Leakage current	0.25 mA max. (@ 254Vac, 60Hz)
Regulatory Requirements	<p>Safety Requirements:</p> <ol style="list-style-type: none"> 1.The subject product rated 100-120V 60Hz must be listed under UL 1950 and certified with SCA Standard C22.2 No.950. 2.The subject product rated 200-240V 50Hz must comply with low voltage directive 73/23EEC. <p>EMI Requirements:</p> <ol style="list-style-type: none"> 1.The subject product rated 100-120V 60Hz must meet the EMI requirements of FCC part 15, Subpart B for Class B Digital Device and get FCC Certification before marketing into USA and Canada. 2.The subject product rated 200-240V 50Hz must meet the EMC Directive 89/336/EEC. 3.The subject product rated 100-120V must meet the VCCI-2 EMI requirements.

Power Management

Power Saving Mode	Phenomenon
Standby Mode Enter Standby Mode when 1. Standby/Hibernation hot-key is pressed and system is not ready to enter Hibernation mode. 2. System standby/ Hibernation timer expires and system is not ready to enter Hibernation mode.	<input type="checkbox"/> The buzzer beeps <input type="checkbox"/> The Sleep indicator lights up
Hibernation Mode Enter Hibernation Mode (suspend to HDD) when 1. Hibernation hot-key is pressed and system is ready to enter Hibernation mode 2. System Hibernation timer expires and system is ready to enter Hibernation mode.	<input type="checkbox"/> All power shuts off
Display Standby Mode Keyboard, built-in touchpad, and an external PS/2 pointing device are idle for a specified period.	<input type="checkbox"/> The display shuts off
Hard Disk Standby Mode Hard disk is idle within a specified period of time.	<input type="checkbox"/> Hard disk drive is in standby mode. (spindle turned-off)

Environmental Requirements

Item	Specification
Temperature	
Operating	+5~+35 °C
Non-operating	-10~+60 °C
Humidity	
Operating	20% to 85% RH, non-condensing
Non-operating	20% to 85% RH, non-condensing (Unpacked)
Non-operating	20% to 90% RH, non-condensing (Storage package)
Vibration	
Operating (unpacked)	5~25.6Hz: 0.38mm (peak to peak) 25.6~250Hz: 0.5G
Non-operating (unpacked)	5~27.1Hz: 0.6G 27.1~50Hz: 0.04mm (peak to peak) 50~500Hz: 2.0G
Non-operating (packed)	5~62.6Hz: 0.51mm (peak to peak) 62.6~500Hz: 4.0G

Mechanical Specification

Item	Specification
Dimensions	326(W) x 275(D) x 39.9~45(H)mm
Weight	7.4lbs with 15"LCD, FDD, HDD, Li, and CD-ROM
I/O Ports	Two type II PCMCIA (PC Card) port, one RJ-11 port, one RJ-45 port, one DC-in port, four USB ports, one IEEE 1394 port, one microphone in (share line-in), one line-out / share with SPDIF, one VGA port., one TV out.

Mechanical Specification

Item	Specification
Drive Bays	One
Material	Plastic
Indicators	Power-on, Standby, Battery Status, Media Access, CapsLock and NumLock
Switch	Power

Memory Address Map

Memory Address	Size	Function
000A0000-000BFFFF	128KB	Mobility RADEON 9000
000A0000-000BFFFF	128KB	PCI Bus
000A0000-000BFFFF	128KB	SiS Accelerated Graphics Port
000C8000-000BFFFF	32KB	Motherboard resources
000C8000-000BFFFF	32KB	PCI Bus
000DA000-000DAFFF	4KB	Texas Instruments PCI-1520 CardBus Controller
000DB000-000DBFFF	4KB	Texas Instruments PCI-1520 CardBus Controller
10000000-FFEDFFFF	3GB	PCI Bus
E4000000-E7FFFFFF	128MB	Texas Instruments PCI-1520 CardBus Controller
E8000000-EBFFFFFF	64MB	SiS Accelerated Graphics Port
EC000000-EC000FFF	4KB	OHCI Compliant IEEE 1394 Host Controller
EC001000-EC001FFF	4KB	SiS 7001 PCI to USB Open Host Controller
EC002000-EC002FFF	4KB	SiS 7001 PCI to USB Open Host Controller
EC003000-EC003FFF	4KB	SiS 7001 PCI to USB Open Host Controller
EC004000-EC004FFF	4KB	SiS 7001 PCI to USB Open Host Controller
EC005000-EC0050FF	256KB	Realtek RTL8139/810X Family Fast Ethernet NIC
EC100000-EC10FFFF	64K	Mobility RADEON 9000
EC100000-EC1FFFFFF	1MB	SiS Accelerated Graphics Port
F0000000-F7FFFFFF	128MB	Mobility RADEON 9000
F0000000-F7FFFFFF	128MB	SiS Accelerated Graphics Port
FAC00000-FEBFFFFFF	64MB	Texas Instruments PCI-1520 CardBus Controller
FEC00000-FEC00FFF	4KB	Motherboard resources
FEE00000-FEE00FFF	4KB	Motherboard resources
FFC00000-FFC00FFF	4KB	Motherboard resources
FFE00000-FFE00FFF	4KB	Motherboard resources
FFE7C000-FFE7CFFF	4KB	Texas Instruments PCI-1520 CardBus Controller
FFE7D000-FFE7DFFF	4KB	Texas Instruments PCI-1520 CardBus Controller
FFE7E000-FFE7EFFF	4KB	Texas Instruments PCI-1520 CardBus Controller

Memory Address Map

Memory Address	Size	Function
FFE7F000-FFE7FFFF	4KB	Texas Instruments PCI-1520 CardBus Controller
FFE80000-FFEFFFFFFF	512KB	Motherboard resources
82200000-82200FFF	4KB	Audio

I/O Address Map

I/O Address	Function
00000000-0000000F	Direct Memory Access controller
00000000-00000CF7	PCI bus
00000020-00000021	Programmable interrupt controller
0000002E-0000002E	Motherboard resources
0000002F-0000002F	Motherboard resources
00000040-00000043	System Timer
00000060-00000060	Standard 101/102-key or Microsoft Natural PS/2 keyboard
00000061-00000061	System Speaker
00000062-00000062	Microsoft ACPI-Compliant Embedded Controller
00000064-00000064	Standard 101/102-key or Microsoft Natural PS/2 keyboard
00000066-00000066	Microsoft ACPI-Compliant Embedded Controller
00000070-00000071	System CMOS/realtime clock
00000080-00000080	Motherboard resources
00000081-0000008F	Direct memory access controller
00000090-00000092	Motherboard resources
000000A0-000000A1	Programmable interrupt controller
000000C0-000000DF	Direct memory access controller
000000F0-000000FF	Numeric data processor
00000170-00000177	Secondary IDE channel
000001F0-000001F7	Primary IDE channel
00000274-00000277	ISAPNP Read Data Report
00000279-00000279	ISAPNP Read Data Report
00000376-00000376	Secondary IDE channel
000003B0-000003BB	Mobility RADEON 9000
000003B0-000003BB	SiS Accelerated Graphics Port
000003C0-000003DF	Mobility RADEON 9000
000003C0-000003DF	SiS Accelerated Graphics Port
000003F0-000003F5	Standard floppy disk controller
000003F6-000003F6	Primary IDE channel
000003F7-000003F7	Standard floppy disk controller
00000480-0000048F	Direct memory access controller
000004D0-000004D1	Motherboard resources
00000A79-00000A79	ISAPNP Read Data Report
00000D00-0000FFFF	PCI bus
00001000-000010FF	Agere Systems AC'97 Modem
00001800-000018FF	Realtek RTL8139/810x Family Fast Ethernet NIC
00001C00-00001C7F	Agere Systems AC'97 Modem
0000A000-0000A0FF	Mobility RADEON 9000

I/O Address Map

I/O Address	Function
0000A000-0000AFFF	SiS Accelerated Graphics Port
0000F900-0000F9FF	Texas Instruments PCI-1520 CardBus Controller
0000FA00-0000FAFF	Texas Instruments PCI-1520 CardBus Controller
0000FC00-0000FCFF	Texas Instruments PCI-1520 CardBus Controller
0000FD00-0000FDFF	Texas Instruments PCI-1520 CardBus Controller
0000FE00-0000FE00	Motherboard resources

IRQ Assignment Map

Interrupt Channel	Function
IRQ0	System timer
IRQ1	Keyboard
IRQ6	Standard FDD Controller
IRQ8	System CMOS Real time clock
IRQ9	Microsoft ACPI-Compliant System
IRQ12	Synaptics PS/2 Port Pointing Device
IRQ13	Numeric Data Processor
IRQ14	IDE Primary channel
IRQ15	IDE Secondary channel
IRQ16	Mobility RADEON 9000
IRQ16	Texas Instruments PCI-1520 CardBus Controller
IRQ17	OHCI Compliant IEEE 1394 Host Controller
IRQ17	Texas Instruments PCI-1520 CardBus Controller
IRQ18	Agere Systems AC'97 Modem
IRQ18	SigmaTel C-Major Audio
IRQ19	Realtek RTL8139/810x Family Fast Ethernet NIC
IRQ20	SiS 7001 PCI to USB Open Host Controller
IRQ21	SiS 7001 PCI to USB Open Host Controller
IRQ22	SiS 7001 PCI to USB Open Host Controller
IRQ23	SiS PCI to USB Enhanced Host Controller

NOTE: IRQ settings may be changed by OS

DMA Channel Assignment

DMA Channel	Function
DRQ0	Not used
DRQ1	Not used
DRQ2	Floppy
DRQ3	Not used
DRQ4	DMA controller
DRQ5	Not used
DRQ6	Not used
DRQ7	Not used

System Utilities

BIOS Setup Utility

The BIOS Setup Utility is a hardware configuration program built into your computer's BIOS (Basic Input/Output System).

Your computer is already properly configured and optimized, and you do not need to run this utility. However, if you encounter configuration problems, you may need to run Setup. Please also refer to Chapter 4 Troubleshooting when problem arises.

To activate the BIOS Utility, press **F2** during POST (while the TravelMate logo is being displayed).

Multi-Boot Menu

Users can press F12 during POST to enter the Multi Boot Selection Menu. In this menu users can change boot device without entering BIOS SETUP utility.

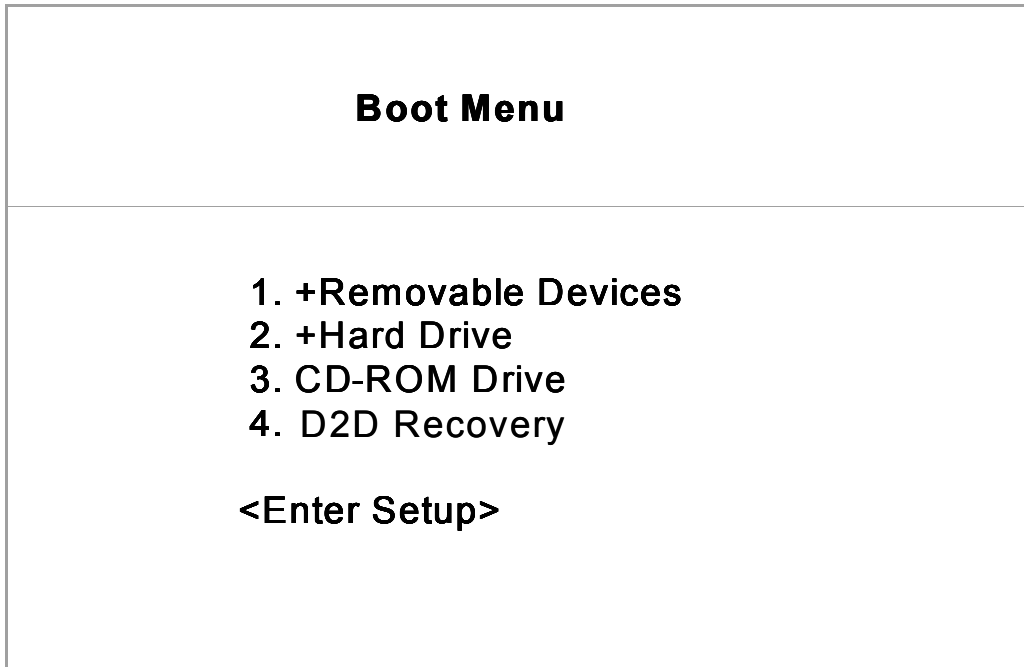





NOTE: If users disable the multi boot selection menu in BIOS SETUP utility, the message “ Press F12 to enter the multi boot selection menu” will not appear during POST.

NOTE: If users disable the “Boot on LAN” option in BIOS SETUP utility, then the option of Realtek Boot Agent will not appear.

Setting the Boot Drive Sequence

The Boot Drive Sequence section lists boot priorities (1st, 2nd, 3rd, and 4th) for bootable drives in your computer.



For example, the default value (1st: Removable Devices, 2nd: Hard Drive, 3rd: CD-ROM Drive, and 4th: D2D Recovery) tells the computer to first search for a removable device. If it finds one present, it boots up from that removable device. If not, the computer continues to search for a hard disk drive. If it cannot boot up from the hard disk drive, it continues by booting up from the CD-ROM drive and etc...

To set the boot drive sequence, use the  /  keys to select a priority level (1st, 2nd, 3rd, and 4th), then use the  /  keys to select the device for that priority level.





NOTE: When Boot on LAN is set Enabled, then the 5th option: Realtek Boot Agent shows in the list.

Navigating the BIOS Utility

There are six menu options: System Information, Main System Settings, Advanced Information, System Security, Boot Options and Exit Setup Settings.

To enter a menu, highlight the item using the  /  keys, then press .

Within a menu, navigate through the BIOS Utility by following these instructions:

- Press the  /  keys to move between the parameters.
- Press the  /  keys to change the value of a parameter.
- Press the  key while you are in any of the menu options to return to the main menu.

NOTE: You can change the value of a parameter if it is enclosed in square brackets. Navigation keys are shown at the bottom of the screen.

System Information

The System Information screen displays a summary of your computer hardware information.

PhoenixBIOS Setup Utility					
Information	Main	Advanced	Security	Boot	Exit
CPU Type:	Intel ® Pentium ® 4 CPU 2.40 GHz				
CPU Speed:	2400 MHz				
System Memory:	640 KB				
Total Memory:	129535 KB				
HDD1 Serial Number	9ZY9ZQE6646				
HDD2 Serial Number	None				
System BIOS Version	R01-A0H				
VGA BIOS Version	ATI Technologies Inc. BK-ATI VER 008				
KBC Version:	02.13.29				
Serial Number	9147Y0100130600007M000				
Asset Tag Number:					
Product Name	Aspire1600				
Manufacture Name	Acer				
UUID Number	XX				
F1 Help ↑↓ Select Item F5/F6 Change Values F9 Setup Defaults Esc Exit ←→ Select Menu Enter Select Sub-Menu F10 Save and Exit					

NOTE: The screen above is a sample and may not reflect the actual data on your computer. "X" may refer to a series of numbers and/or characters.

The following table describes the information in this screen.

Parameter	Description
CPU Type	Describe the type of CPU installed in the system.
CPU Speed	Show the speed of CPU installed in the system.
System Memory	Display the current system memory.
Total Memory	Display the current total system memory.
HDD Serial Number	Display the primary master HDD serial number. If there is no primary master HDD, then show "None".
System BIOS Version	Show the current system BIOS version.
VGA BIOS Version	Show the video graphics accelerator BIOS version. It is obtained from VGA BIOS.
KBC Version	Display the current KBC version.
Serial Number	Show the serial number of the computer. (32 characters)
Asset Tag Number	Show the asset tag number of the computer. (16 characters)
Product Name	Show the official name of the product. (15 characters)

Parameter	Description
Manufacturer Name	Show the manufacturer of the computer. (15 characters)
UUID	Show the universally unique identifier of your computer. (16 Byte-Hex-Digital)

The items in this screen are important and vital information about your computer. If you experience computer problems and need to contact technical support, this data helps our service personnel know more about your computer.

Main System Settings

The Basic System Settings screen allows you to set the system date and time.

PhoenixBIOS Setup Utility					
Information	Main	Advanced	Security	Boot	Exit
System Time:			[08:46:55]		Item Specific Help
System Date:			[01/07/2003]		
Boot Display			[Auto]		Adjust calendar clock <Tab>, <Shift-Tab>, or <Enter> selects field.
Screen Expansion:			[Enabled]		
QuickBoot Mode:			[Enabled]		
Boot Time Diagnostic Screen			[Disabled]		
Boot on Lan			[Disabled]		
Hotkey Beep:			[Enabled]		
Auto Dimm			[Enabled]		
F12 Multi-Boot			[Enabled]		
F1 Help ↑↓ Select Item F5/F6 Change Values F9 Setup Defaults Esc Exit ←→ Select Menu Enter Select Sub-Menu F10 Save and Exit					

The following table describes the parameters in this screen.

Parameter	Description	Format
System Time	Sets the system time.	HH:MM:SS (hour:minute:second)
System Date	Sets the system date.	DDD MMM DD, YYYY (day-of-the-week month day, year)
Boot Display	Sets the display output device on boot up. When set to Auto , the computer automatically determines the display device. If an external display device (e.g., monitor) is connected, it becomes the boot display. When set to Both , the computer outputs to both the computer display screen and an external display device if one is connected.	Auto or Both
Screen Expansion	Enable or disable the screen expansion function.	Enabled or Disabled
Quick Boot Mode	Allow the system to skip certain tests while booting. This will decrease the time needed to boot the system.	Enabled or Disabled

Parameter	Description	Format
Boot-time Diagnostic Screen	Display logo screen during boot. Note: Enable to show the acer TravelMate picture screen on boot up.	Disabled or Enabled
Boot on LAN	When it is enabled, a remote host with an appropriate boot image can boot this computer via the internal LAN. Note: Need to restart system for enabling Boot-on-LAN function.	Disabled or Enabled
Hotkey Beep	Enable or disable hotkey beep.	Enabled or Disabled
Auto Dim	The system will support an automatic dimming of the LCD backlight when the AC power is NOT available (running on battery power).	Enabled or Disabled
F12 Multi-Boot	Users could choose if to display 'Fn-F12 for multi-boot' message during post.	Enabled or Disabled

Advanced Information

The Advanced Information screen contains parameter values that define how your computer behaves on system startup.

<i>PhoenixBIOS Setup Utility</i>					
<i>Information</i>	<i>Main</i>	Advanced	<i>Security</i>	<i>Boot</i>	<i>Exit</i>
Legacy Diskette A:			[1.44/1.25MB]		Item Specific Help
. Primary Master			[FUJITSU MHS2040AT]		Select Floppy Disk type.
. Secondary Master			[UJDA740 DVD/CDRW]		
Hyper Threading Technology			[Disabled]		
. PCI IRQ Routing					
Resume on LAN/Modem Access:			[Enabled]		
Reset Configuration Data:			[No]		
System Boot From Hard Disk					
Recovery			[Enabled]		
F1 Help ↑↓ Select Item F5/F6 Change Values F9 Setup Defaults Esc Exit ←→ Select Menu Enter Select Sub-Menu F10 Save and Exit					

The following table describes the parameters in this screen. Settings in boldface are the default and suggested parameter settings.

Parameter	Description	Options
Legacy Diskette A	Enable or Disable Legacy Diskette A Note: Selects floppy type. Note that 1.25MB references a 1024 byte/sector Japanese media format. The 1.25MB diskette requires a 3-Mode floppy-disk drive.	1.44/1.25MB or Disabled
Primary Master	Show IDE Primary Master HDD size. User can enter submenu to set some detail functions	Auto , User, None or ATAPI Removable
Secondary Master	Show IDE Secondary Master Device Status. User can enter submenu to set some detail functions.	Auto , User, None or ATAPI Removable
Hyper Threading Technology	Enables 2nd logical processor. Note: This setting is only available for CPU 3.06GHz or above.	Disabled or Enabled
PCI IRQ Routing	Set Default IRQ of PCI device. Note: Menu used to set IRQ for PCI Devices.	Auto/ User Select
Resume on LAN/Modem Access	Set Enabled or Disabled to wake on LAN/Modem access.	Enabled or Disabled
Reset Configuration Data	Select "Yes" to clear the extended system configuration (ESCD) data.	No or Yes
System Boot From Hard Disk Recovery	Recovery from hard disk drive, which contains ghost image.	Enabled or Disabled

Primary Master

The Primary Master sub-menu contains parameters related to the primary hard disk.

CAUTION: The parameters in this screen are for the advanced users only. Typically, you do not need to change the values in this screen. The default setting of **Auto** optimizes all the settings for your hard disk.

<i>PhoenixBIOS Setup Utility</i>		
<i>Advanced</i>		
Primary Master [FUJITSU MHS2040AT D-(PM)]		Item Specific Help
Type: LBA	[Auto] Format	Select ATA/ATAPI drive installed here
Total Sectors:	78140160	[Auto]
Maximum Capacity:	40008MB	The BIOS auto-types the drive on boot time.
Multi-Sector Transfers:	[16 Sectors]	Except [Auto]
LBA Mode Control:	[Enable]	You enter parameters of the drive.
32 Bit I/O:	[Disabled]	[None]
Transfer Mode:	[Fast PIO 4]	The drive is disabled.
Ultra DMA Mode:	[Mode 5]	
F1 Help ↑↓ Select Item F5/F6 Change Values F9 Setup Defaults Esc Exit ←→ Select Menu Enter Select Sub-Menu F10 Save and Exit		

Parameter	Description	Options
Type	The setting of detail functions stands on type. Note: Auto= Autotype Hard-Disk drive installed here.	Auto /None/ ATAPI Removable/User

The following table describes the parameters in this screen. Settings in **boldface** are the default and suggested parameter settings.

NOTE: When the device is disabled, all the sub-items will be hidden.

Secondary Master

The Secondary Master sub-menu contains parameters related to the Media bay drive.

CAUTION: The parameters in this screen are for the advanced users only. Typically, you do not need to change the values in this screen. The default setting of Auto optimizes all the settings for your Media bay drive.

<i>PhoenixBIOS Setup Utility</i>		
<i>Advanced</i>		
IDE Secondary Master [UJDA740 DVD/CDRW-(SM)]		Item Specific Help
Type:	[Auto]	Select ATA/ATAPI drive installed here. [Auto] The BIOS auto-types the drive on boot time. Except [Auto] You enter parameters of the drive. [None] The drive is disabled.
Multi-Sector Transfers:	[Disabled]	
LBA Mode Control:	[Disabled]	
32 Bit I/O:	[Disabled]	
Transfer Mode:	[Fast PIO 4]	
Ultra DMA Mode:	[Mode 2]	
F1 Help ↑↓ Select Item F5/F6 Change Values F9 Setup Defaults Esc Exit ←→ Select Menu Enter Select Sub-Menu F10 Save and Exit		

Parameter	Description	Options
Type	The setting of detail functions stands on type. Note: Auto= Autotype Hard-Disk drive installed here	Auto/ None/ ATAPI Removable/ User

The following table describes the parameters in this screen. Settings in **boldface** are the default and suggested parameter settings.

NOTE: When the device is disabled, all the sub-items will be hidden.

PCI IRQ Routing

The PCI IRQ Routing sub-menu allows you to set IRQ for PCI devices.

CAUTION: The parameters in this screen are for advanced users only. Typically, you do not need to change the values in this screen because these values are already optimized.

PhoenixBIOS Setup Utility		
Advanced		
PCI IRQ Routing	Item Specific Help	
PCI IRQ A# : [11] PCI IRQ B# : [11] PCI IRQ C# : [11] PCI IRQ D# : [11] PCI IRQ E# : [11] PCI IRQ F# : [11] PCI IRQ G# : [11] PCI IRQ H# : [11]	PCI devices can use hardware interrupts called IRQs. A PCI device cannot use IRQs already in use by ISA or EISA devices. Use 'Auto' only if no ISA or Eisa legacy cards are installed.	
F1 Help ↑↓ Select Item F5/F6 Change Values F9 Setup Defaults Esc Exit ←→ Select Menu Enter Select Sub-Menu F10 Save and Exit		

Parameter	Description	Options
PIRQ A-H#	Set default IRQ of PCI device. Note: PCI devices can use hardware interrupt called IRQs. A PCI device cannot use IRQs already in use by ISA or EISA devices. Use "Auto Select" only if no ISA or EISA legacy cards are installed.	IRQ11 , Disabled, Auto Select, IRQ3, IRQ7, IRQ10

System Security

The System Security screen contains parameters that help safeguard and protect your computer from unauthorized use.

<i>PhoenixBIOS Setup Utility</i>					
<i>Information</i>	<i>Main</i>	<i>Advanced</i>	Security	<i>Boot</i>	<i>Exit</i>
Set Supervisor Password			[Enter]		Item Specific Help Press <Enter> key to set Supervisor Password to enable any password features. Then password entry is required to enter BIOS Setup.
Set User Password			[Enter]		
Password on boot:			[Disabled]		
Set Primary Hard Disk Password			[Enter]		
Processor Serial Number			[Enabled]		
F1 Help ↑/↓ Select Item F5/F6 Change Values F9 Setup Defaults Esc Exit ←/→ Select Menu Enter Select Sub-Menu F10 Save and Exit					

The following table describes the parameters in this screen. Settings in **boldface** are the default and suggested parameter settings.

Parameter	Description	Options
Set Supervisor Password	While entering SETUP, BIOS need to request user to enter supervisor password if set. This password protects the BIOS SETUP menu from unauthorized entry.	Enter
Set User Password	During POST, BIOS need to check user password if set. This password protects the system from unauthorized user entry before OS boots up.	Enter
Password on Boot	During POST, BIOS need to check power on password if set. This password protects the computer from unauthorized entry during boot-up.	Disabled or Enabled
Set Primary Hard Disk Password	During POST, BIOS need to check hard disk password if set. This password protects the computer from unauthorized entry during boot-up if a second Hard disk is inserted.	Enter
Processor Serial Number	Display the process serial number.	Enabled or Disabled

Setting a Password

Follow these steps:

1. Use the cursor **↑/↓** keys to highlight a Password parameter (Supervisor Password, User Password, Password on boot or Primary Hard Disk Password) and press the **ENTER** key. The password box appears as below if choosing Set Supervisor Password:

Set Supervisor Password	
Enter New Password	[]
Confirm New Password	[]

2. Type a password. The password may consist of up to eight characters (A-Z, a-z, 0-9) and then press **ENTER**.

IMPORTANT: Be very careful when typing your password because the characters do not appear on the screen.

3. Retype password to verify your first entry and then press **ENTER**. The following screen appears:

Setup Notice
Changes have been saved. [Continue]

4. After setting the password, the computer automatically sets the chosen password parameter to Present.
5. Press **ESC** to return to the main menu.
6. Press **F10**. The following dialogue box appears.

Setup Confirmation
Save Configuration changes and exit now?
[Yes] [No]

7. Select **Yes** and press **ENTER** to save the password and exit the BIOS utility.

Four password types protect your computer from unauthorized access. Setting these passwords creates several different levels of protection for your computer and data:

- Supervisor Password prevents unauthorized entry to the BIOS Utility. Once set, you must key-in this password to gain access to the BIOS Utility.
- User Password and Password On Boot secure your computer against unauthorized use. Combine the use of this password with password checkpoints on boot-up and resume from hibernation for maximum security.
- Hard Disk Password protects your data by preventing unauthorized access to your hard disk. Even if the hard disk is removed from the computer and moved to another computer, it cannot be accessed without the Hard Disk Password.

When a password is set, a password prompt appears on the left-hand corner of the display screen.

1. When the Supervisor Password is set, the following prompt appears when you press **F2** to enter the BIOS Utility at boot-up.

Enter Password

Type the Supervisor Password and press **ENTER** to access the BIOS Utility.

2. When the User Password is set and Power on boot is set enabled, the following prompt appears at boot-up when pressing **F2**.

Enter Password

Type the User Password (a symbol appears for each character you type) and press **ENTER** to use the computer. If you enter the password incorrectly, an **x** symbol appears. Try again and press **ENTER**.

3. When the Power on boot is set enabled, the following prompt appears at boot-up.

Enter Password

4. When the Hard Disk Password is set, the following prompt appears at boot-up.

Enter Password

Type the Hard Disk Password (a symbol appears for each character you type) and press **ENTER** to use the computer. If you enter the password incorrectly, an **x** symbol appears. Try again and press **ENTER**.

You have three chances to enter a password. If you successfully entered the password, the system starts Windows.

Removing a Password

If you fail to enter the password correctly after three tries, the system hangs.

To change a password, follow the same steps used to set a password.

1. Use the cursor **↑**/**↓** keys to highlight a Password parameter (Supervisor Password, User Password, Password on boot) and press **ENTER**. The following prompt appears:

Enter Current Password []
Enter New Password []
Confirm New Password []

2. Type Current Password, leave the “ Enter New Password” blank and press **ENTER**. Leave “ Confirm New Password” blank and press **ENTER**, then the password is removed.

Boot Options

Users can press F12 during POST to enter the Boot Options Menu directly (See “Multi-Boot Menu” on page 35), or by entering BIOS SETUP utility, Boot Options item.

<i>PhoenixBIOS Setup Utility</i>					
Information	Main	Advanced	Security	Boot	Exit
+Removable Devices +Hard Drive CD-ROM Drive D2D Recovery				Item Specific Help <Shift + 1> enables or disables a device. <+>/<Space> or <-> moves the device up or down. <d> removes a device that is not installed.	
F1 Help	↑↓ Select Item	F5/F6 Change Values	F9 Setup Defaults		
Esc Exit	←→ Select Menu	Enter Select Sub-Menu	F10 Save and Exit		

NOTE: There are four defaulted options that allow users to specify the boot device sequence. If the “Boot on LAN” option is enabled, then, Realtek Boot Agent will be shown as the fifth option.

The priority of options from top to bottom is 1st, 2nd, 3rd, and 4th.

If the Removable Device or Hard Drive option has multi devices, show ‘+’ in front of option and show each device information.

NOTE: Keys used to view or configure devices:

<ENTER> expands or collapses devices with a + or -

<F5> and <F6> moves the device up and or down.

Exit Setup

This menu contains exit options.

PhoenixBIOS Setup Utility					
Information	Main	Advanced	Security	Boot	Exit
Exit Saving Changes Exit Discarding Changes Load Setup Defaults Discard Changes Save Changes					Item Specific Help Exit System Setup and save your changes to CMOS.
F1 Help	↑↓	Select Item	F5/F6 Change Values	F9 Setup Defaults	
Esc Exit	←→	Select Menu	Enter Select Sub-Menu	F10 Save and Exit	

The following table describes the parameters in this screen. Setting in **boldface** are the defaults and suggested parameter settings.

Parameter	Description
Exit Saving Changes	Save any changes, and exit BIOS setup. Note: Exit System Setup and save your changes to CMOS.
Exit Discarding Changes	Discard any changes, and exit BIOS setup. Note: Exit utility without saving Setup data to CMOS.
Load Setup Defaults	Load Setup Defaults. Note: Load default values for all SETUP items.
Discard Changes	Discard any changes. Note: Load previous value from CMOS for all SETUP items.
Save Changes	Save changes. Note: Save Setup data to CMOS.

Load Setup Default

If you want to restore all parameter settings to their default values, select this menu item and press **ENTER**. The following dialog box displays.

Do you want to load default settings?

[Yes] [No]

If you would like to load factory- default settings for all parameters, use the cursor **←** / **→** keys to select **Yes**; then press **ENTER**. Choose **No** if otherwise.

BIOS Flash Utility

The BIOS flash memory update is required for the following conditions:

- New versions of system programs
- New features or options

Use the PHFlash or WFlash utility to update the system BIOS flash ROM.

Executing the PHFlash Program

Please do the following to update BIOS in DOS environment.

1. Copy the ZIP file to your HDD. The recommended directory is C:\drivers\BIOS
2. Then unzip it with -d option to store the sub-directories. ex.)PKUNZIP -d C:\drivers\BIOS*.zip
C:\drivers\BIOS.
3. Reboot to pure DOS.
4. Run C:\drivers\BIOS\BIOS.BAT
5. Follow displayed procedures to flash system BIOS.

Executing the WFlash Program

Please do the following to update BIOS in Windows environment.

1. Boot into system.
2. Run "WistronWFlash.exe".
3. In WFlash windows, choose "LOAD BIOS BINARY FILE". Choose the new binary file you want to use for updates.
4. Choose "SAVE ROM BIOS TO FILE" as backup.
5. Choose "PROGRAM BIOS". BIOS is updated.

NOTE: Should the procedure is not successfully completed, go to step 3, choose the ROM file saved in step 4. And, then, "PROGRAM BIOS". The system will be recovered to the original BIOS version.

NOTE: .

System Utility Diskette

This utility diskette is for the Aspire 1600 notebook machine. You can find the utility in Service CD kit. It provides the following functions:

1. 1394 GUID Utility
2. Mother Board Data Utility

To use this diskette, first boot from this diskette, then a "Microsoft Windows ME Startup Menu" prompt you to choose the testing item. Follow the instructions on screen to proceed.

NOTE: This program contains a readme.txt file. This readme.txt file will introduce each test utility and its functions

Machine Disassembly and Replacement

This chapter contains step-by-step procedures on how to disassemble the notebook computer for maintenance and troubleshooting.

To disassemble the computer, you need the following tools:

- Wrist grounding strap and conductive mat for preventing electrostatic discharge
- Number 1 Flat-bladed screwdriver
- Phillips screwdriver
- Plastic Flat-bladed screwdriver
- Number 5 Hexed screwdriver

NOTE: The screws for the different components vary in size. During the disassembly process, group the screws with the corresponding components to avoid mismatch when putting back the components.

General Information

Before You Begin

Before proceeding with the disassembly procedure, make sure that you do the following:

1. Turn off the power to the system and all peripherals.
2. Unplug the AC adapter and all power and signal cables from the system.

Disassembly Procedure Flowchart

The flowchart on the succeeding page gives you a graphic representation on the entire disassembly sequence and instructs you on the components that need to be removed during servicing. For example, if you want to remove the main board, you must first remove the keyboard, then disassemble the inside assembly frame in that order.

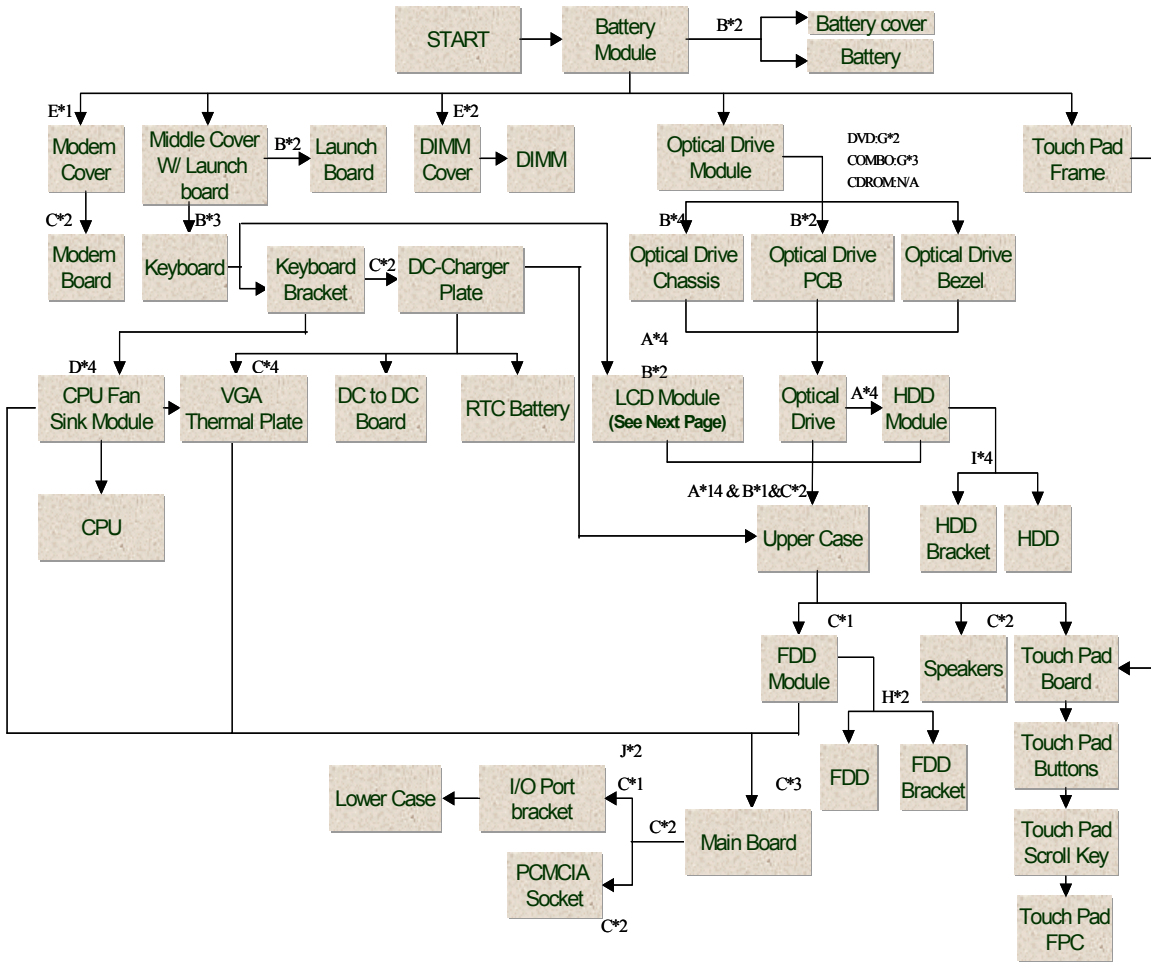

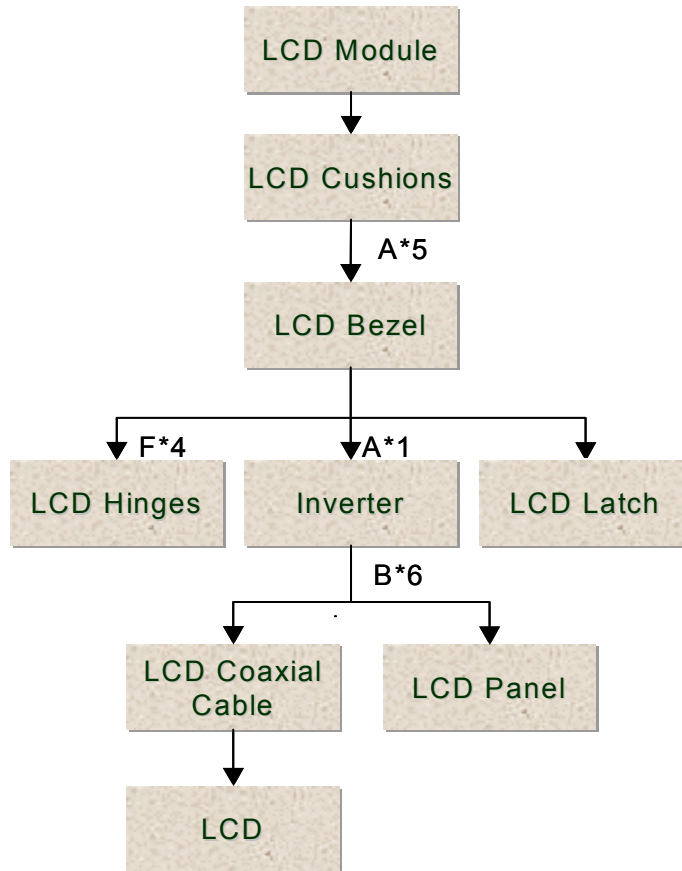

Screw List

Item	Description
A	Screw M2.5XL6 (Black)
B	Screw M2XL4 (Silver)
C	Screw M2XL5 (Silver)
D	Screw M2.5XL18 (Silver)
E	Screw M2XL4 (Black)
F	Screw M2.5XL5 (Black)
G	Screw M1.7XL3 (Black)
H	Screw M2.5XL4 (Silver)
I	Screw M3XL4 (Silver)
J	Hex Screw

Removing the Battery Pack

1. To remove the battery, first unlock the battery lock button, push the two battery release buttons, and then slide the battery pack out from the machine.



Disassembling the Battery Pack

1. See “Removing the Battery Pack” on page 56
2. Remove the two screws, and then detach the battery from the battery cover.



Removing the Optical Drive Module

1. See “Removing the Battery Pack” on page 56
2. Release the release button and then slide the optical drive module out from the main unit.



Disassembling the Optical Drive Module

1. See “Removing the Battery Pack” on page 56
2. See “Removing the Optical Drive Module” on page 57
3. To disassemble the optical drive module, first remove the four screws as shown.

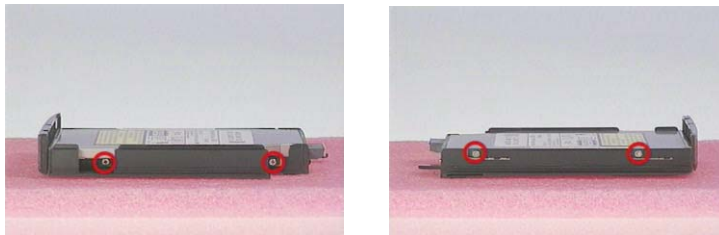

4. Detach the optical drive module from the optical drive chassis.



5. Remove the two screws and then detach the optical drive PCB from the optical drive module.



Removing the Hard Disk Drive Module

1. See “Removing the Battery Pack” on page 56
2. See “Removing the Optical Drive Module” on page 57
3. Remove the four screws as shown and then pull the plastic tag to detach the hard disk drive module out from the machine carefully.

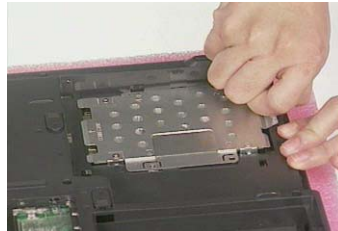
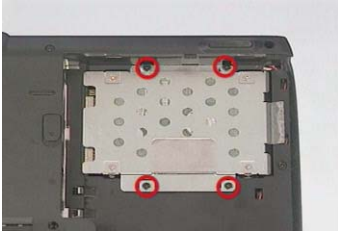

Disassembling the Hard Disk Drive Module

1. See “Removing the Battery Pack” on page 56
2. See “Removing the Optical Drive Module” on page 57
3. See “Removing the Hard Disk Drive Module” on page 58
4. To disassemble the hard disk drive module, first remove the four screws from the hard disk drive bracket.

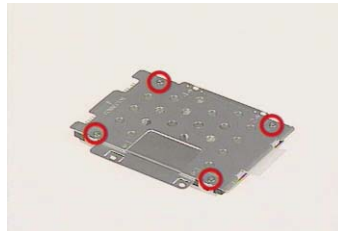

5. Detach the hard disk drive bracket from the hard disk drive.



Removing the Memory Module

1. See “Removing the Battery Pack” on page 56
2. To remove the memory module from the machine, first remove the one screw from the memory cover.

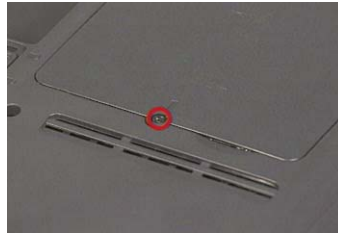

3. Lift the cover off, and then remove the memory cover.

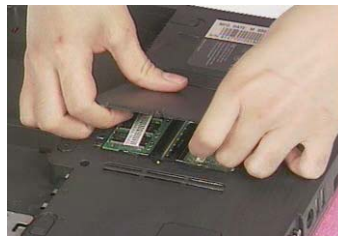

4. Push out the latches on both sides of the socket and pull the memory module out from the socket.



Removing the Modem Board

1. See “Removing the Battery Pack” on page 56
2. To remove the modem board, first remove the screw from the modem cover.



3. Remove the modem cover from the machine.



4. Remove two screws from the modem board as shown, disconnect the modem cable from the modem board, and then remove the modem board from the main unit carefully by using a plastic flat bladed screw driver.



5. Disconnect the modem cable from the modem board, then remove the modem board.



Disassembling the LCD

Removing the Middle Cover

1. See “Removing the Battery Pack” on page 56
2. Pry up the middle cover with a plastic flat screwdriver, pull the middle cover up carefully



3. Turn the middle cover over and disconnect the launch board cable from the launch board and then detach the middle cover away from the main unit.



Removing the Launch Board

1. See “Removing the Battery Pack” on page 56
2. See “Removing the Middle Cover” on page 61
3. Remove the two screws and then detach the launch board from the middle cover.

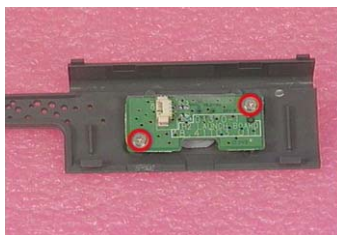

Removing the Keyboard

1. See “Removing the Battery Pack” on page 56
2. See “Removing the Middle Cover” on page 61
3. To remove the keyboard, first remove the three screws as shown here.



4. Lift the keyboard upward carefully and put it on the upper case.



5. Use a plastic flat screwdriver to help disconnect the keyboard cable from the main board carefully, then remove the keyboard from the main board.

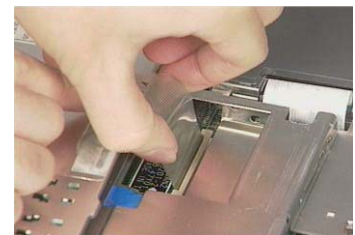

Removing the LCD Module

1. See “Removing the Battery Pack” on page 56
2. See “Removing the Middle Cover” on page 61
3. See “Removing the Keyboard” on page 62
4. Remove the two screws from the base of the unit.



5. Remove the screw and disconnect the LCD coaxial cable from the main board.

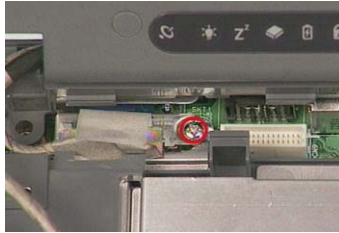

6. Remove the inverter cable from the main board with a plastic flat screwdriver.



7. Remove the four screws as shown and then detach the LCD module from the main unit carefully.

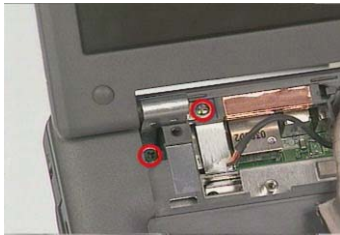

NOTE: Please arrange the coaxial cable and the inverter cable well in the way as shown after you connect them to the main board.



Removing the LCD Bezel

1. See “Removing the Battery Pack” on page 56
2. See “Removing the Middle Cover” on page 61
3. See “Removing the Keyboard” on page 62
4. See “Removing the LCD Module” on page 62
5. Remove the four LCD cushions as shown and the middle lower mylar on the LCD bezel, and then remove the five screws below from the LCD bezel.



6. Snap off the bezel carefully, and then remove the LCD bezel from the LCD module.



Removing the Inverter Board

1. See “Removing the Battery Pack” on page 56
2. See “Removing the Middle Cover” on page 61
3. See “Removing the Keyboard” on page 62
4. See “Removing the LCD Module” on page 62
5. See “Removing the LCD Bezel” on page 63
6. To remove the inverter board, first remove the screw from the inverter board.



7. Disconnect the LCD power cable, remove the inverter board from the LCD panel, and then disconnect the inverter cable from the inverter board.

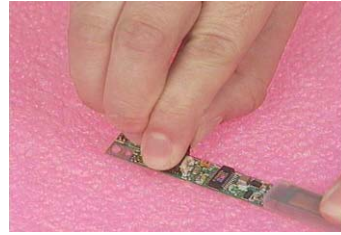

Removing the LCD

1. See “Removing the Battery Pack” on page 56
2. See “Removing the Middle Cover” on page 61
3. See “Removing the Keyboard” on page 62
4. See “Removing the LCD Module” on page 62
5. See “Removing the LCD Bezel” on page 63
6. See “Removing the Inverter Board” on page 64
7. To remove the LCD, first remove the six screws from both sides of the LCD, then remove the LCD from the LCD panel.

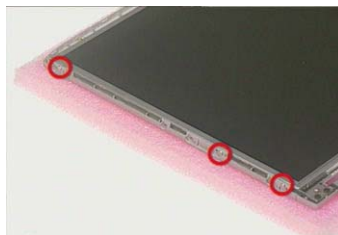
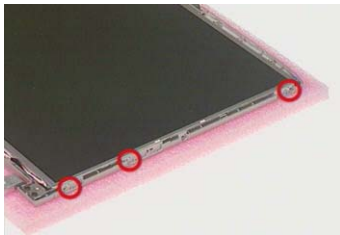

Removing the LCD Hinges

1. See “Removing the Battery Pack” on page 56
2. See “Removing the Middle Cover” on page 61
3. See “Removing the Keyboard” on page 62
4. See “Removing the LCD Module” on page 62
5. See “Removing the LCD Bezel” on page 63
6. Remove four screws to remove the LCD hinges and then detach the LCD hinges from the LCD.





Removing the LCD Coaxial Cable

1. See “Removing the Battery Pack” on page 56
2. See “Removing the Middle Cover” on page 61
3. See “Removing the Keyboard” on page 62
4. See “Removing the LCD Module” on page 62
5. See “Removing the LCD Bezel” on page 63
6. See “Removing the Inverter Board” on page 64
7. Remove the tapes then remove the LCD coaxial cable from the LCD.

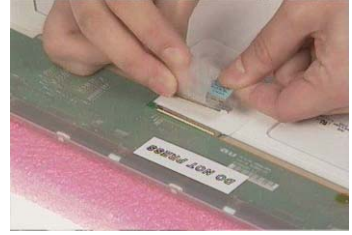

Disassembling the Main Unit

Removing the Keyboard Bracket

1. See “Removing the Battery Pack” on page 56
2. See “Removing the Middle Cover” on page 61
3. See “Removing the Keyboard” on page 62
4. Remove the keyboard support bracket from the main unit carefully.



Removing the DC Charger Plate

1. See “Removing the Battery Pack” on page 56
2. See “Removing the Middle Cover” on page 61
3. See “Removing the Keyboard” on page 62
4. See “Removing the LCD Module” on page 62
5. Remove the two screws as shown and then detach the DC charger Plate from the main board.

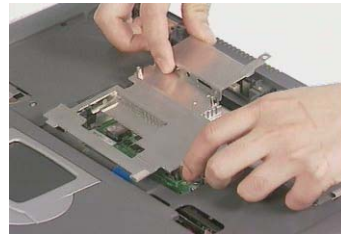
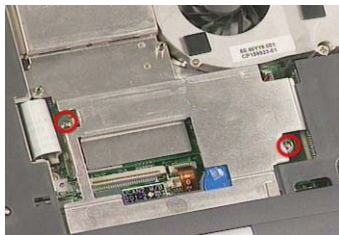

Removing the RTC Battery

1. See “Removing the Battery Pack” on page 56
2. See “Removing the Middle Cover” on page 61
3. See “Removing the Keyboard” on page 62
4. See “Removing the Keyboard Bracket” on page 67
5. See “Removing the DC Charger Plate” on page 67
6. Disconnect the RTC cable and then remove the RTC battery from the upper case gently.

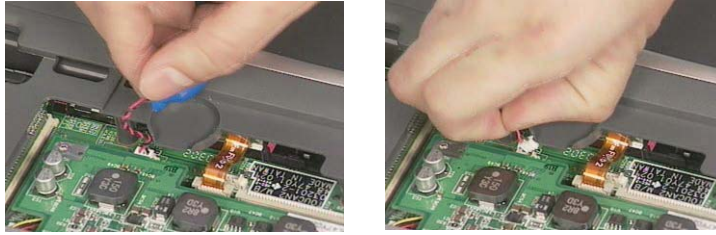

Removing the Touch Pad Frame

1. See “Removing the Battery Pack” on page 56
2. Release the latches with a plastic flat screwdriver carefully.

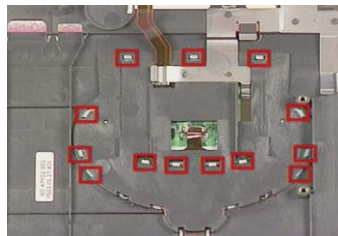

3. Detach the touch pad frame from the upper case gently.



Removing the DC to DC Board

1. See “Removing the Battery Pack” on page 56
2. See “Removing the Middle Cover” on page 61
3. See “Removing the Middle Cover” on page 61
4. See “Removing the Keyboard” on page 62
5. See “Removing the Keyboard Bracket” on page 67
6. Detach the DC to DC board from the main board gently.



Removing the CPU Fan Sink

1. See “Removing the Battery Pack” on page 56
2. See “Removing the Middle Cover” on page 61
3. See “Removing the Keyboard” on page 62
4. See “Removing the Keyboard Bracket” on page 67
5. Disconnect the CPU fan cable, remove four screws, and then detach the CPU fan sink from the main unit.

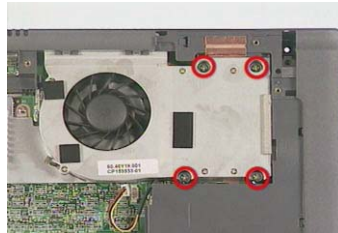
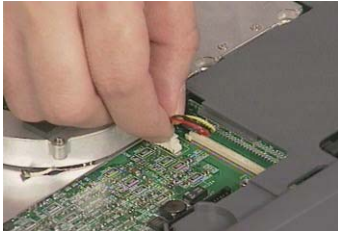

Removing the Processor

1. See “Removing the Battery Pack” on page 56
2. See “Removing the Middle Cover” on page 61
3. See “Removing the Keyboard” on page 62
4. See “Removing the Keyboard Bracket” on page 67
5. See “Removing the CPU Fan Sink” on page 69
6. Lift up the CPU socket lever, remove the CPU from the CPU socket carefully, and then put the CPU socket lever back to its original position.



Installing the Processor

1. See “Removing the Battery Pack” on page 56
2. See “Removing the Middle Cover” on page 61
3. See “Removing the Keyboard” on page 62
4. See “Removing the Keyboard Bracket” on page 67
5. See “Removing the CPU Fan Sink” on page 69
6. Lift up the CPU socket lever, install the CPU to the CPU socket carefully, and then put the CPU socket lever back to its original position to secure the CPU well.

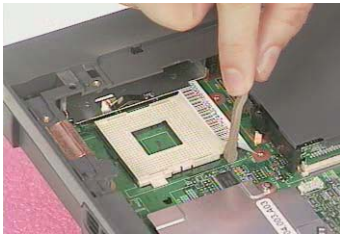

NOTE: Please make sure the CPU is attached with PIN1 on this side.



Removing the Upper Case

1. See “Removing the Battery Pack” on page 56
2. See “Removing the Optical Drive Module” on page 57
3. See “Removing the Hard Disk Drive Module” on page 58
4. See “Removing the Middle Cover” on page 61
5. See “Removing the Keyboard” on page 62
6. See “Removing the LCD Module” on page 62
7. See “Removing the Keyboard Bracket” on page 67
8. See “Removing the DC Charger Plate” on page 67
9. Use a plastic flat screwdriver to disconnect the touch pad cable from the main board.

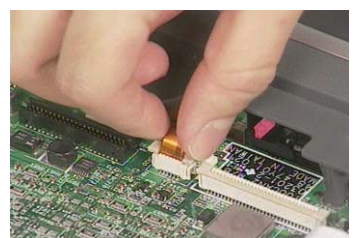
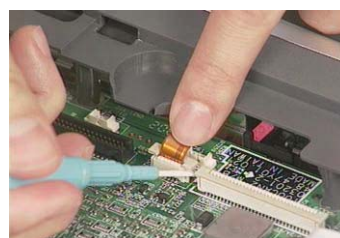
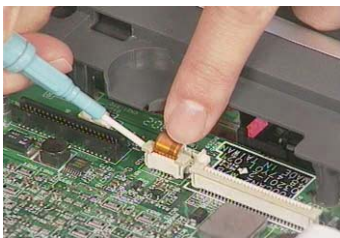

10. To remove the upper case, first remove the two screws from the front side, and then remove the fifteen screws from the backside of the main unit.

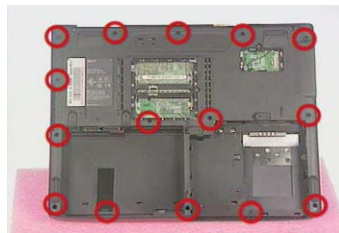
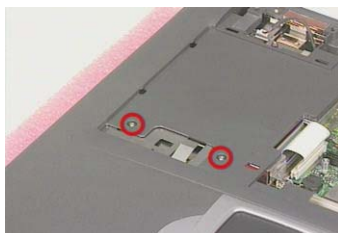

11. Pull the upper case from the unit gently.



Removing the Touch Pad Board

1. See “Removing the Battery Pack” on page 56
2. See “Removing the Hard Disk Drive Module” on page 58
3. See “Removing the Middle Cover” on page 61
4. See “Removing the Keyboard” on page 62
5. See “Removing the LCD Module” on page 62
6. See “Removing the Keyboard Bracket” on page 67
7. See “Removing the DC Charger Plate” on page 67
8. See “Removing the Touch Pad Frame” on page 68
9. See “Removing the Upper Case” on page 70
10. To detach the touch pad board, first disconnect the touch pad cable from the touch pad board with a plastic flat screwdriver and plastic tweezers, and then remove the touch pad board from the upper case.



Removing the Touch Pad Button

1. See “Removing the Battery Pack” on page 56
2. See “Removing the Hard Disk Drive Module” on page 58
3. See “Removing the Middle Cover” on page 61
4. See “Removing the Keyboard” on page 62
5. See “Removing the LCD Module” on page 62
6. See “Removing the Keyboard Bracket” on page 67
7. See “Removing the DC Charger Plate” on page 67
8. See “Removing the Touch Pad Frame” on page 68
9. See “Removing the Upper Case” on page 70
10. See “Removing the Touch Pad Board” on page 71
11. Remove the touch pad button.



Removing the Touch Pad Scroll Key

1. See “Removing the Battery Pack” on page 56
2. See “Removing the Hard Disk Drive Module” on page 58
3. See “Removing the Middle Cover” on page 61
4. See “Removing the Keyboard” on page 62
5. See “Removing the LCD Module” on page 62
6. See “Removing the Keyboard Bracket” on page 67
7. See “Removing the DC Charger Plate” on page 67
8. See “Removing the Touch Pad Frame” on page 68
9. See “Removing the Upper Case” on page 70
10. See “Removing the Touch Pad Board” on page 71
11. See “Removing the Touch Pad Button” on page 71
12. Detach the touch pad scroll key from the upper case.



Removing the Touch Pad FPC

1. See “Removing the Battery Pack” on page 56
2. See “Removing the Hard Disk Drive Module” on page 58
3. See “Removing the Middle Cover” on page 61
4. See “Removing the Keyboard” on page 62
5. See “Removing the LCD Module” on page 62
6. See “Removing the Keyboard Bracket” on page 67
7. See “Removing the DC Charger Plate” on page 67
8. See “Removing the Touch Pad Frame” on page 68
9. See “Removing the Upper Case” on page 70
10. See “Removing the Touch Pad Board” on page 71
11. See “Removing the Touch Pad Button” on page 71
12. Detach the touch pad FPC from the upper case carefully.

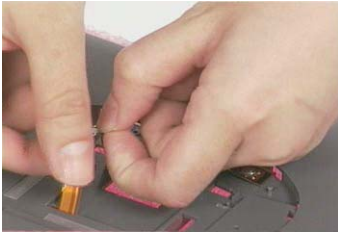

Removing the VGA Thermal Plate

1. See “Removing the Battery Pack” on page 56
2. See “Removing the Hard Disk Drive Module” on page 58
3. See “Removing the Middle Cover” on page 61
4. See “Removing the Keyboard” on page 62
5. See “Removing the Keyboard Bracket” on page 67
6. See “Removing the DC Charger Plate” on page 67
7. See “Removing the CPU Fan Sink” on page 69
8. Remove the four screws and then detach the VGA thermal plate from the main board.

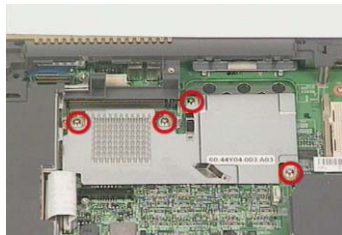

Removing the Floppy Disk Drive Module

1. See “Removing the Battery Pack” on page 56
2. See “Removing the Optical Drive Module” on page 57
3. See “Removing the Hard Disk Drive Module” on page 58
4. See “Removing the Middle Cover” on page 61
5. See “Removing the Keyboard” on page 62
6. See “Removing the LCD Module” on page 62
7. See “Removing the Keyboard Bracket” on page 67
8. See “Removing the DC Charger Plate” on page 67
9. See “Removing the Upper Case” on page 70
10. Disconnect the FDD cable from the main board and remove the one screw.

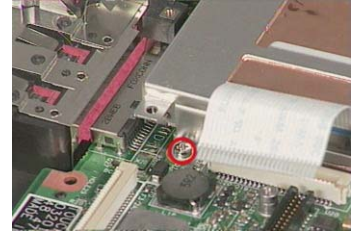
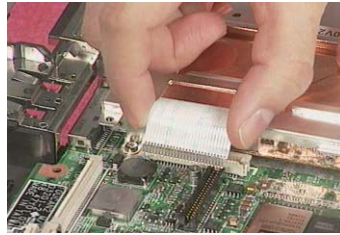
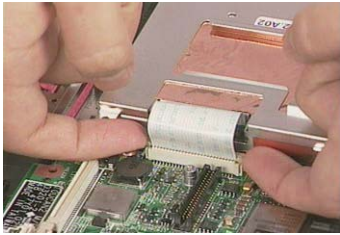

11. Detach the FDD module from the lower case.

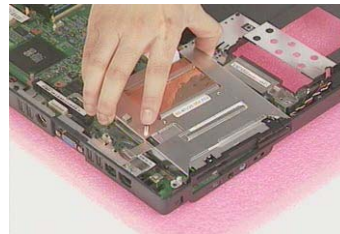

Disassembling the Floppy Disk Drive Module

1. See “Removing the Battery Pack” on page 56
2. See “Removing the Optical Drive Module” on page 57
3. See “Removing the Hard Disk Drive Module” on page 58
4. See “Removing the Middle Cover” on page 61
5. See “Removing the Keyboard” on page 62
6. See “Removing the LCD Module” on page 62
7. See “Removing the Keyboard Bracket” on page 67
8. See “Removing the DC Charger Plate” on page 67
9. See “Removing the Upper Case” on page 70
10. See “Removing the Floppy Disk Drive Module” on page 73
11. To disassemble the floppy disk drive from the disk drive module, first remove the two screws as shown here and then detach the floppy disk from the floppy disk drive bracket



12. Disconnect the floppy disk drive FPC cable gently from the floppy disk drive.



Removing the Speakers

1. See “Removing the Battery Pack” on page 56
2. See “Removing the Optical Drive Module” on page 57
3. See “Removing the Hard Disk Drive Module” on page 58
4. See “Removing the Middle Cover” on page 61
5. See “Removing the Keyboard” on page 62
6. See “Removing the LCD Module” on page 62
7. See “Removing the Keyboard Bracket” on page 67
8. See “Removing the DC Charger Plate” on page 67
9. See “Removing the Upper Case” on page 70
10. To remove the speakers, first remove the two tapes, disconnect the cable from the main board and then remove the two screws.

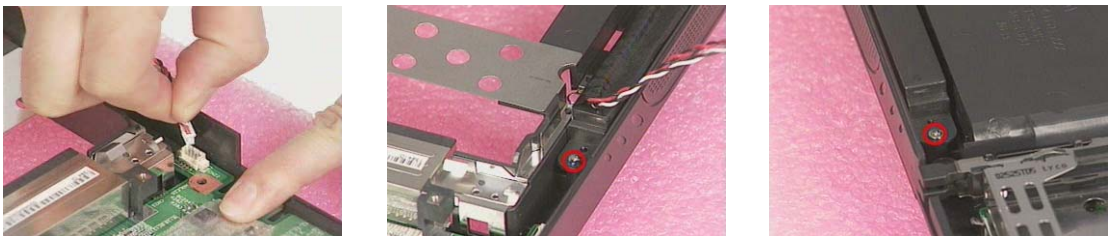
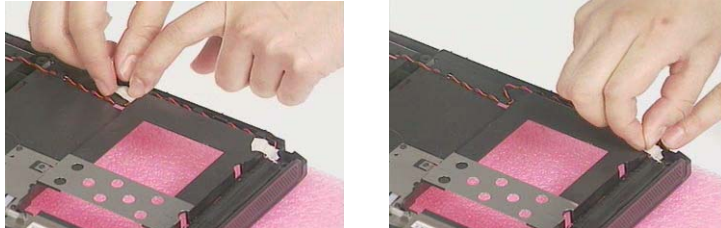

11. Remove the speakers and speaker cable from the lower case gently.



NOTE: Please pay attention to how the speaker cable is routed when the speakers are attached back to the main unit.

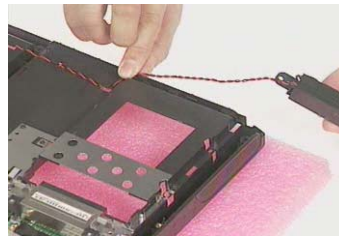
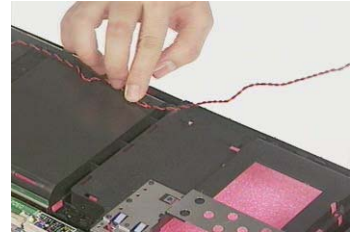
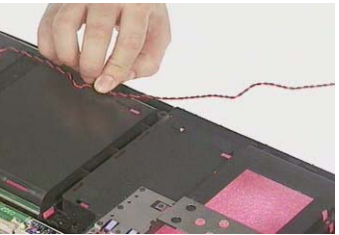
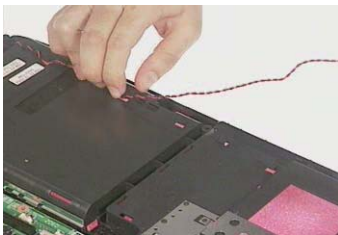
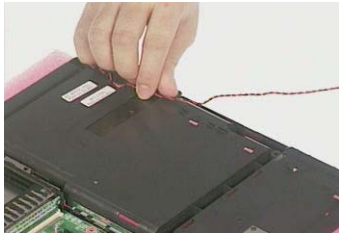
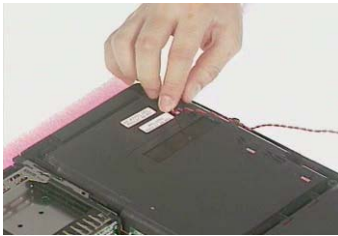

Removing the Main Board

1. See "Removing the Battery Pack" on page 56
2. See "Removing the Optical Drive Module" on page 57
3. See "Removing the Hard Disk Drive Module" on page 58
4. See "Removing the Middle Cover" on page 61
5. See "Removing the Keyboard" on page 62
6. See "Removing the LCD Module" on page 62
7. See "Removing the Keyboard Bracket" on page 67
8. See "Removing the DC Charger Plate" on page 67
9. See "Removing the DC to DC Board" on page 68

10. See “Removing the Upper Case” on page 70
11. See “Removing the Floppy Disk Drive Module” on page 73
12. See “Removing the VGA Thermal Plate” on page 73
13. Disconnect the launch board cable and the speaker cable from the main board.

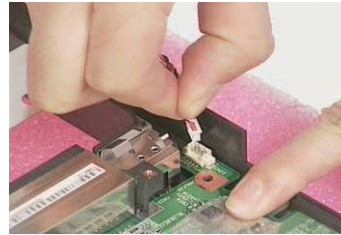

14. Remove the three screws as shown and detach the main board from the lower case carefully in the way as shown here.

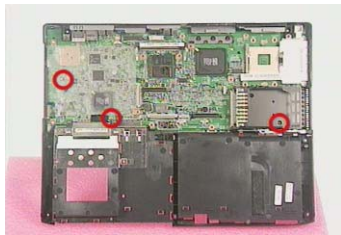

Removing the PCMCIA Slot

1. See “Removing the Battery Pack” on page 56
2. See “Removing the Optical Drive Module” on page 57
3. See “Removing the Hard Disk Drive Module” on page 58
4. See “Removing the Middle Cover” on page 61
5. See “Removing the Keyboard” on page 62
6. See “Removing the LCD Module” on page 62
7. See “Removing the Keyboard Bracket” on page 67
8. See “Removing the DC Charger Plate” on page 67
9. See “Removing the DC to DC Board” on page 68
10. See “Removing the Upper Case” on page 70
11. See “Removing the Floppy Disk Drive Module” on page 73
12. See “Removing the VGA Thermal Plate” on page 73
13. See “Removing the Main Board” on page 76
14. Remove four screws from the PCMCIA plate to remove the plate.

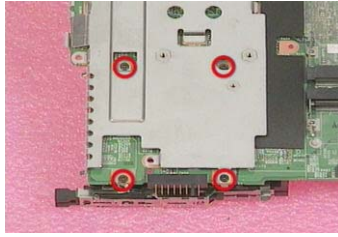

15. Detach the PCMCIA slot from the main board.

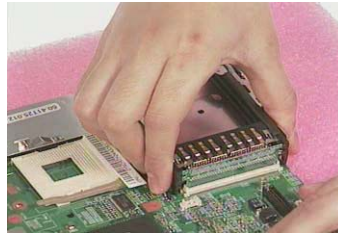

Removing the I/O Port Bracket

1. See “Removing the Battery Pack” on page 56
2. See “Removing the Optical Drive Module” on page 57
3. See “Removing the Hard Disk Drive Module” on page 58
4. See “Removing the Middle Cover” on page 61
5. See “Removing the Keyboard” on page 62
6. See “Removing the LCD Module” on page 62
7. See “Removing the Keyboard Bracket” on page 67
8. See “Removing the DC Charger Plate” on page 67
9. See “Removing the DC to DC Board” on page 68
10. See “Removing the Upper Case” on page 70
11. See “Removing the Floppy Disk Drive Module” on page 73
12. See “Removing the VGA Thermal Plate” on page 73
13. See “Removing the Main Board” on page 76
14. Remove the two screws as shown.

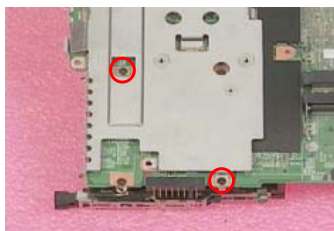

15. Remove the two hex screws and the other one screw as shown to detach the I/O port bracket from the main board.

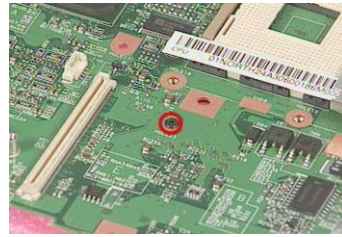
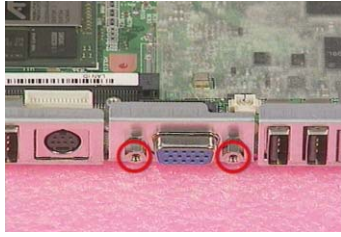

16. Detach the I/O port bracket from the main board.



Troubleshooting

Use the following procedure as a guide for Aspire 1606 computer problems.

NOTE: The diagnostic tests are intended to test only Acer products. Non-Acer products, prototype cards, or modified options can give false errors and invalid system responses.

1. Obtain the failing symptoms in as much detail as possible.
2. Verify the symptoms by attempting to re-create the failure by running the diagnostic test or by repeating the same operation.
3. Use the following table with the verified symptom to determine which page to go to.

Symptoms (Verified)	Go To
Power failure. (The power indicator does not go on or stay on.)	"Power System Check" on page 82.
POST does not complete. No beep or error codes are indicated.	"Power-On Self-Test (POST) Error Message" on page 85 "Undetermined Problems" on page 97
POST detects an error and displayed messages on screen.	"Error Message List" on page 86
The diagnostic test detected an error and displayed a FRU code.	"System Utility Diskette" on page 51
Other symptoms (i.e. LCD display problems or others).	"Power-On Self-Test (POST) Error Message" on page 85
Symptoms cannot be re-created (intermittent problems).	Use the customer-reported symptoms and go to "Power-On Self-Test (POST) Error Message" on page 85 "Intermittent Problems" on page 96 "Undetermined Problems" on page 97

System Check Procedures

External Diskette Drive Check

Do the following to isolate the problem to a controller, driver, or diskette. A write-enabled, diagnostic diskette is required.

NOTE: Make sure that the diskette does not have more than one label attached to it. Multiple labels can cause damage to the drive or cause the drive to fail.

Do the following to select the test device. See ““System Utility Diskette” on page 51 for details.

1. Boot from the diagnostics diskette and start the PQA program (see “System Utility Diskette” on page 51).
2. Go to the diagnostic Diskette Drive in the test items.
3. Press **F2** in the test items.
4. Follow the instructions in the message window.

If an error occurs with the internal diskette drive, first turn off the power and then reconnect the diskette connector to the system board.

If the error still remains:

1. Reconnect the external diskette drive/CD-ROM module.
2. Replace the external diskette drive/CD-ROM module.
3. Replace the system board.

External CD-ROM Drive Check

Do the following to isolate the problem to a controller, drive, or CD-ROM. Make sure that the CD-ROM does not have any label attached to it. The label can cause damage to the drive or can cause the drive to fail.

Do the following to select the test device:

1. Boot from the diagnostics diskette and start the PQA program (refer to .
2. Go to the diagnostic CD-ROM in the test items.
3. Press **F2** in the test items.
4. Follow the instructions in the message window.

If an error occurs, first turn off the power and then reconnect the connector to the system board. If the error still remains:

1. Reconnect the external diskette drive/CD-ROM module.
2. Replace the external diskette drive/CD-ROM module.
3. Replace the system board.

Keyboard or Auxiliary Input Device Check

Remove the external keyboard if the internal keyboard is to be tested.

If the internal keyboard does not work or an unexpected character appears, make sure that the flexible cable extending from the keyboard is correctly seated in the connector on the system board.

If the keyboard cable connection is correct, run the Keyboard Test. See “System Utility Diskette” on page 51 for details.

If the tests detect a keyboard problem, do the following one at a time to correct the problem. Do not replace a non-defective FRU:

1. Reconnect the keyboard cables.
2. Replace the keyboard.
3. Replace the system board.

The following auxiliary input devices are supported by this computer:

- Numeric keypad
- External keyboard

If any of these devices do not work, reconnect the cable connector and repeat the failing operation.

Memory Check

Memory errors might stop system operations, show error messages on the screen, or hang the system.

1. Boot from the diagnostics diskette and start the PQA program (please refer to “System Utility Diskette” on page 51).
2. Go to the diagnostic memory in the test items.
3. Press **F2** in the test items.
4. Follow the instructions in the message window.

NOTE: Make sure that the DIMM is fully installed into the connector. A loose connection can cause an error.

Power System Check

To verify the symptom of the problem, power on the computer using each of the following power sources:

1. Remove the battery pack.
2. Connect the power adapter and check that power is supplied.
3. Disconnect the power adapter and install the charged battery pack; then check that power is supplied by the battery pack.

If you suspect a power problem, see the appropriate power supply check in the following list:

- “Check the Power Adapter” on page 83
- “Check the Battery Pack” on page 84

Check the Power Adapter

Unplug the power adapter cable from the computer and measure the output voltage at the plug of the power adapter cable. See the following figure

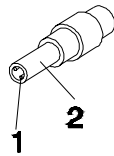

Pin 1: +19.5 to +21.0V
Pin 2: 0V, Ground

1. If the voltage is not correct, replace the power adapter.
2. If the voltage is within the range, do the following:
 - Replace the System board.
 - If the problem is not corrected, see “Undetermined Problems” on page 97.
 - If the voltage is not correct, go to the next step.

NOTE: An audible noise from the power adapter does not always indicate a defect.

3. If the power-on indicator does not light up, check the power cord of the power adapter for correct continuity and installation.
4. If the operational charge does not work, see “Check the Battery Pack” on page 84.

Check the Battery Pack

To check the battery pack, do the following:

From Software:

1. Check out the Power Management in control Panel
2. In Power Meter, confirm that if the parameters shown in the screen for Current Power Source and Total Battery Power Remaining are correct.
3. Repeat the steps 1 and 2, for both battery and adapter.
4. This helps you identify first the problem is on recharging or discharging.

From Hardware:

1. Power off the computer.
2. Remove the battery pack and measure the voltage between battery terminals 1(ground) and 7(+). See the following figure

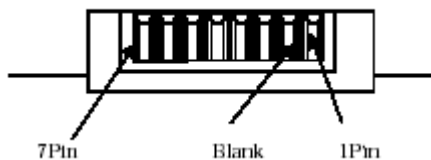

3. If the voltage is still less than 4.22 Vdc after recharging, replace the battery.

To check the battery charge operation, use a discharged battery pack or a battery pack that has less than 50% of the total power remaining when installed in the computer.

If the battery status indicator does not light up, remove the battery pack and let it return to room temperature. Re-install the battery pack.

If the charge indicator still does not light up, replace the battery pack. If the charge indicator still does not light up, replace the DC/DC charger board.

Touchpad Check

If the touchpad doesn't work, do the following actions one at a time to correct the problem. Do not replace a non-defective FRU:

1. Reconnect the touchpad cables.
2. Replace the touchpad.
3. Replace the system board.

After you use the touchpad, the pointer drifts on the screen for a short time. This self-acting pointer movement can occur when a slight, steady pressure is applied to the touchpad pointer. This symptom is not a hardware problem. No service actions are necessary if the pointer movement stops in a short period of time.

Power-On Self-Test (POST) Error Message

The POST error message index lists the error message and their possible causes. The most likely cause is listed first.

NOTE: Perform the FRU replacement or actions in the sequence shown in FRU/Action column, if the FRU replacement does not solve the problem, put the original part back in the computer. Do not replace a non-defective FRU.

This index can also help you determine the next possible FRU to be replaced when servicing a computer.

If the symptom is not listed, see “Undetermined Problems” on page 97.

The following lists the error messages that the BIOS displays on the screen and the error symptoms classified by function.

NOTE: Most of the error messages occur during POST. Some of them display information about a hardware device, e.g., the amount of memory installed. Others may indicate a problem with a device, such as the way it has been configured.

NOTE: If the system fails after you make changes in the BIOS Setup Utility menus, reset the computer, enter Setup and install Setup defaults or correct the error.

Index of Error Messages

Error Code List

Error Codes	Error Messages
006	Equipment Configuration Error Causes: 1. CPU BIOS Update Code Mismatch 2. IDE Primary Channel Master Drive Error 3. IDE Secondary Channel Master Drive Error (The causes will be shown before "Equipment Configuration Error")
010	Memory Error at xxxx:xxx:xxxh (R:xxxh, W:xxxh)
070	Real Time Clock Error
071	CMOS Battery Bad
072	CMOS Checksum Error
110	Incorrect password specified, system disabled. (Text mode only)
<No error code>	Battery critical LOW In this situation BIOS will issue 4 short beeps then shut down system, no message will show.
<No error code>	Thermal critical High In this situation BIOS will issue 3 long beeps then shut down system.

Error Message List

Error Messages	FRU/Action in Sequence
Failure Fixed Disk	Reconnect hard disk drive connector. "Load Default Settings" in BIOS Setup Utility. Hard disk drive System board
Stuck Key	see "Keyboard or Auxiliary Input Device Check" on page 82.
Keyboard error	see "Keyboard or Auxiliary Input Device Check" on page 82.
Keyboard Controller Failed	see "Keyboard or Auxiliary Input Device Check" on page 82.
Keyboard locked - Unlock key switch	Unlock external keyboard
Monitor type does not match CMOS - Run Setup	Run "Load Default Settings" in BIOS Setup Utility.
Shadow RAM Failed at offset: nnnn	BIOS ROM System board
System RAM Failed at offset: nnnn	DIMM System board
Extended RAM Failed at offset: nnnn	DIMM System board
System battery is dead - Replace and run Setup	Replace RTC battery and Run BIOS Setup Utility to reconfigure system time, then reboot system.
System CMOS checksum bad - Default configuration used	RTC battery Run BIOS Setup Utility to reconfigure system time, then reboot system.
System timer error	RTC battery Run BIOS Setup Utility to reconfigure system time, then reboot system. System board

Error Message List

Error Messages	FRU/Action in Sequence
Real time clock error	RTC battery Run BIOS Setup Utility to reconfigure system time, then reboot system. System board
Previous boot incomplete - Default configuration used	Run "Load Default Settings" in BIOS Setup Utility. RTC battery System board
Memory size found by POST differed from CMOS	Run "Load Default Settings" in BIOS Setup Utility. DIMM System board
Diskette drive A error	Check the drive is defined with the proper diskette type in BIOS Setup Utility See "External Diskette Drive Check" on page 81.
Incorrect Drive A type - run SETUP	Check the drive is defined with the proper diskette type in BIOS Setup Utility See "External Diskette Drive Check" on page 81.
System cache error - Cache disabled	System board
CPU ID:	System board
DMA Test Failed	DIMM System board
Software NMI Failed	DIMM System board
Fail-Safe Timer NMI Failed	DIMM System board
Device Address Conflict	Run "Load Default Settings" in BIOS Setup Utility. RTC battery System board
Allocation Error for device	Run "Load Default Settings" in BIOS Setup Utility. RTC battery System board
Failing Bits: nnnn	DIMM BIOS ROM System board
Fixed Disk n	None
Invalid System Configuration Data	BIOS ROM System board
I/O device IRQ conflict	Run "Load Default Settings" in BIOS Setup Utility. RTC battery System board
Operating system not found	Enter Setup and see if fixed disk and drive A: are properly identified. Diskette drive Hard disk drive System board

Error Message List

No beep Error Messages	FRU/Action in Sequence
No beep, power-on indicator turns off and LCD is blank.	Power source (battery pack and power adapter). See "Power System Check" on page 82. Ensure every connector is connected tightly and correctly. Reconnect the DIMM. LED board. System board.
No beep, power-on indicator turns on and LCD is blank.	Power source (battery pack and power adapter). See "Power System Check" on page 82. Reconnect the LCD connector Hard disk drive LCD inverter ID LCD cable LCD Inverter LCD System board
No beep, power-on indicator turns on and LCD is blank. But you can see POST on an external CRT.	Reconnect the LCD connectors. LCD inverter ID LCD cable LCD inverter LCD System board
No beep, power-on indicator turns on and a blinking cursor shown on LCD during POST.	Ensure every connector is connected tightly and correctly. System board
No beep during POST but system runs correctly.	Speaker System board

Error Beep List

Code	Beeps	Description
00h	Two long beeps, one short beep, then one long beep.	Success
F1h	One long and one short beeps.	BIOS file size mismatch
F2h	One long and two short beeps	BIOS reading error
D1h	Two short beeps.	Floppy drive not installed

POST Codes

Code	Beeps	POST Routine Description
02h		Verify Real Mode
03h		Disable Non-Maskable Interrupt (NMI)
04h		Get CPU type
06h		Initialize system hardware
08h		Initialize chipset with initial POST values
09h		Set IN POST flag
0Ah		Initialize CPU registers
0Bh		Enable CPU cache
0Ch		Initialize caches to initial POST values
0Eh		Initialize I/O component
0Fh		Initialize the local bus IDE
10h		Initialize Power Management
11h		Load alternate registers with initial POST values
12h		Restore CPU control word during warm boot
13h		Initialize PCI Bus Mastering devices
14h		Initialize keyboard controller
16h	1-2-2-3	BIOS ROM checksum
17h		Initialize cache before memory autosize
18h		8254 timer initialization
1Ah		8237 DMA controller initialization
1Ch		Reset Programmable Interrupt Controller
20h	1-3-1-1	Test DRAM refresh
22h	1-3-1-3	Test 8742 Keyboard Controller
24h		Set ES segment register to 4 GB
26h		Enable A20 line
28h		Autosize DRAM
29h		Initialize POST Memory Manager
2Ah		Clear 215 KB base RAM
2Ch	1-3-4-1	RAM failure on address line xxxx
2Eh	1-3-4-3	RAM failure on data bits xxxx of low byte of memory bus
2Fh		Enable cache before system BIOS shadow
30h	1-4-1-1	RAM failure on data bits xxxx of high byte of memory bus
32h		Test CPU bus-clock frequency
33h		Initialize Phoenix Dispatch Manager
36h		Warm start shut down
38h		Shadow system BIOS ROM
3Ah		Autosize cache
3Ch		Advanced configuration of chipset registers
3Dh		Load alternate registers with CMOS values
42h		Initialize interrupt vectors
45h		POST device initialization
46h	2-1-2-3	Check ROM copyright notice

Code	Beeps	POST Routine Description
48h		Check video configuration against CMOS
49h		Initialize PCI bus and devices
4Ah		Initialize all video adapters in system
4Bh		QuietBoot start (optional)
4Ch		Shadow video BIOS ROM
4Eh		Display BIOS copyright notice
50h		Display CPU type and speed
51h		Initialize EISA board
52h		Test keyboard
54h		Set key click if enabled
58h	2-2-3-1	Test for unexpected interrupts
59h		Initialize POST display service
5Ah		Display prompt "Press F2 to enter SETUP"
5Bh		Disable CPU cache
5Ch		Test RAM between 512 and 640 KB
60h		Test extended memory
62h		Test extended memory address lines
64h		Jump to User Patch1
66h		Configure advanced cache registers
67h		Initialize Multi Processor APIC
68h		Enable external and CPU caches
69h		Setup System Management Mode (SMM) area
6Ah		Display external L2 cache size
6Bh		Load custom defaults (optional)
6Ch		Display shadow-area message
6Eh		Display possible high address for UMB recovery
70h		Display error messages
72h		Check for configuration errors
76h		Check for keyboard errors
7Ch		Set up hardware interrupt vectors
7Eh		Initialize coprocessor if present
80h		Disable onboard Super I/O ports and IRQs
81h		Late POST device initialization
82h		Detect and install external RS232 ports
83h		Configure non-MCD IDE controllers
84h		Detect and install external parallel ports
85h		Initialize PC-compatible PnP ISA devices
86h		Re-initialize onboard I/O ports
87h		Configure Motherboard Configurable Devices (optional)
88h		Initialize BIOS Area
89h		Enable Non-Maskable Interrupts (NMIs)
8Ah		Initialize Extended BIOS Data Area
8Bh		Test and initialize PS/2 mouse
8Ch		Initialize floppy controller

Code	Beeps	POST Routine Description
8Fh		Determine number of ATA drives (optional)
90h		Initialize hard-disk controllers
91h		Initialize local-bus hard-disk controllers
92h		Jump to UserPatch2
93h		Build MPTABLE for multi-processor boards
95h		Install CD ROM for boot
96h		Clear huge ES segment register
97h		Fixup Multi Processor table
98h	1-2	Search for option ROMs. One long, two short beeps on checksum failure.
99h		Check for SMART drive (optional)
9Ah		Shadow option ROMs
9Ch		Set up Power Management
9Dh		Initialize security engine (optional)
9Eh		Enable hardware interrupts
9Fh		Determine number of ATA and SCSI drives
A0h		Set time of day
A2h		Check key lock
A4h		Initialize Typematic rate
A8h		Erase F2 prompt
AAh		Scan for F2 key stroke
ACh		Enter SETUP
A Eh		Clear Boot flag
B0h		Check for errors
B2h		POST done- prepare to boot operating system
B4h	1	One short beep before boot
B5h		Terminate QuietBoot (optional)
B6h		Check password (optional)
B9h		Prepare Boot
BAh		Initialize DMI parameters
BBh		Initialize PnP Option ROMs
BCh		Clear parity checkers
BDh		Display MultiBoot menu
BEh		Clear screen (optional)
BFh		Check virus and backup reminders
C0h		Try to boot with INT 19
C1h		Initialize POST Error Manager (PEM)
C2h		Initialize error logging
C3h		Initialize error display function
C4h		Initialize system error handler
C5h		PnPnd dual CMOS (optional)
C6h		Initialize notebook docking (optional)
C7h		Initialize notebook docking late
C8h		Force check (optional)
C9h		Extended checksum (optional)
D2h		Unknown interrupt

Code	Beeps	For Boot Block in Flash ROM
E0h		Initialize the chipset
E1h		Initialize the bridge
E2h		Initialize the CPU
E3h		Initialize the system timer
E4h		Initialize system I/O
E5h		Check force recovery boot
E6h		Checksum BIOS ROM
E7h		Go to BIOS
E8h		Set Huge Segment
E9h		Initialize Multi Processor
EAh		Initialize OEM special code
EBh		Initialize PIC and DMA
ECh		Initialize Memory type
EDh		Initialize Memory size
EEh		Shadow Boot Block
EFh		System memory test
F0h		Initialize interrupt vectors
F1h		Initialize Run Time Clock
F2h		Initialize video
F3h		Initialize System Management Mode
F4h	1	Output one beep before boot
F5h		Boot to Mini DOS
F6h		Clear Huge Segment
F7h		Boot to Full DOS

Index of Symptom-to-FRU Error Message

LCD-Related Symptoms

Symptom / Error	Action in Sequence
LCD backlight doesn't work LCD is too dark LCD brightness cannot be adjuste	Enter BIOS Utility to execute "Load Setup Default Settings", then reboot system. Reconnect the LCD connectors. Keyboard (if contrast and brightness function key doesn't work). LCD inverter ID LCD cable LCD inverter LCD System board
Unreadable LCD screen Missing pels in characters Abnormal screen Wrong color displayed	Reconnect the LCD connector LCD inverter ID LCD cable LCD inverter LCD System board
LCD has extra horizontal or vertical lines displayed.	LCD inverter ID LCD inverter LCD cable LCD System board

Indicator-Related Symptoms

Symptom / Error	Action in Sequence
Indicator incorrectly remains off or on, but system runs correctly	Reconnect the inverter board Inverter board System board

Power-Related Symptoms

Symptom / Error	Action in Sequence
Power shuts down during operation	Power source (battery pack and power adapter). See "Power System Check" on page 82. Battery pack Power adapter Hard drive & battery connection board System board
The system doesn't power-on.	Power source (battery pack and power adapter). See "Power System Check" on page 82. Battery pack Power adapter Hard drive & battery connection board System board
The system doesn't power-off.	Power source (battery pack and power adapter). See "Power System Check" on page 82. Hold and press the power switch for more than 4 seconds. System board
Battery can't be charged	See "Check the Battery Pack" on page 84. Battery pack System board

PCMCIA-Related Symptoms

Symptom / Error	Action in Sequence
System cannot detect the PC Card (PCMCIA)	PCMCIA slot assembly System board
PCMCIA slot pin is damaged.	PCMCIA slot assembly

Memory-Related Symptoms

Symptom / Error	Action in Sequence
Memory count (size) appears different from actual size.	Enter BIOS Setup Utility to execute "Load Default Settings, then reboot system. DIMM System board

Speaker-Related Symptoms

Symptom / Error	Action in Sequence
In Windows, multimedia programs, no sound comes from the computer.	Audio driver Speaker System board
Internal speakers make noise or emit no sound.	Speaker System board

Power Management-Related Symptoms

Symptom / Error	Action in Sequence
The system will not enter hibernation	Keyboard (if control is from the keyboard) Hard disk drive System board
The system doesn't enter hibernation mode and four short beeps every minute.	See "Hibernation Mode" on page 29. Press Fn+F4 and see if the computer enters hibernation mode. Touchpad Keyboard Hard disk connection board Hard disk drive System board
The system doesn't enter standby mode after closing the LCD	See "Hibernation Mode" on page 29. LCD cover switch System board
The system doesn't resume from hibernation mode.	See "Hibernation Mode" on page 29. Hard disk connection board Hard disk drive System board
The system doesn't resume from standby mode after opening the LCD.	See "Hibernation Mode" on page 29. LCD cover switch System board
Battery fuel gauge in Windows doesn't go higher than 90%.	Remove battery pack and let it cool for 2 hours. Refresh battery (continue use battery until power off, then charge battery). Battery pack System board

Power Management-Related Symptoms

Symptom / Error	Action in Sequence
System hangs intermittently.	Reconnect hard disk/CD-ROM drives. Hard disk connection board System board

Peripheral-Related Symptoms

Symptom / Error	Action in Sequence
System configuration does not match the installed devices.	Enter BIOS Setup Utility to execute "Load Default Settings", then reboot system. Reconnect hard disk/CD-ROM/diskette drives.
External display does not work correctly.	Press Fn+F5, LCD/CRT/Both display switching See "System Utility Diskette" on page 51. System board
USB does not work correctly	See "System Utility Diskette" on page 51 System board
Print problems.	Ensure the "Parallel Port" in the "Onboard Devices Configuration" of BIOS Setup Utility is set to Enabled. Onboard Devices Configuration Run printer self-test. Printer driver Printer cable Printer System Board

Keyboard/Touchpad-Related Symptoms

Symptom / Error	Action in Sequence
Keyboard (one or more keys) does not work.	Reconnect the keyboard cable. Keyboard System board
Touchpad does not work.	Reconnect touchpad cable. Touchpad board System board

Modem-Related Symptoms

Symptom / Error	Action in Sequence
Internal modem does not work correctly.	See "System Utility Diskette" on page 51. Modem phone port modem combo board System board

NOTE: If you cannot find a symptom or an error in this list and the problem remains, see "Undetermined Problems" on page 97.

Intermittent Problems

Intermittent system hang problems can be caused by a variety of reasons that have nothing to do with a hardware defect, such as: cosmic radiation, electrostatic discharge, or software errors. FRU replacement should be considered only when a recurring problem exists.

When analyzing an intermittent problem, do the following:

1. Run the advanced diagnostic test for the system board in loop mode at least 10 times.
2. If no error is detected, do not replace any FRU.
3. If any error is detected, replace the FRU. Rerun the test to verify that there are no more errors.

Undetermined Problems

The diagnostic problems does not identify which adapter or device failed, which installed devices are incorrect, whether a short circuit is suspected, or whether the system is inoperative.

Follow these procedures to isolate the failing FRU (do not isolate non-defective FRU).

NOTE: Verify that all attached devices are supported by the computer.

NOTE: Verify that the power supply being used at the time of the failure is operating correctly. (See "Power System Check" on page 82):

1. Power-off the computer.
2. Visually check them for damage. If any problems are found, replace the FRU.
3. Remove or disconnect all of the following devices:
 - Non-Acer devices
 - Printer, mouse, and other external devices
 - Battery pack
 - Hard disk drive
 - DIMM
 - CD-ROM/Diskette drive Module
 - PC Cards
4. Power-on the computer.
5. Determine if the problem has changed.
6. If the problem does not recur, reconnect the removed devices one at a time until you find the failing FRU.
7. If the problem remains, replace the following FRU one at a time. Do not replace a non-defective FRU:
 - System board
 - LCD assembly

Index of Phlash16 Error Message

Error Codes	Error Message
-1 or // FF	Memory allocation for Backup file buffer failed.
-2 or // FE	BIOS.BAK already exists (rename or delete it)
-3 or // FD	File Create failed on BIOS.BAK
-4 or // FC	File Write failed on BIOS.BAK
-5 or // FB	File Close failed on BIOS.BAK
-6 or // FA	BIOS backup not supported in BIOS ROM file.
-7 or // F9	File Open failed on BIOS ROM file.
-8 or // F8	File Read failed on BIOS ROM file.
-9 or // F7	File Close failed on BIOS ROM file.
-10or // F6	Failed to locate signature bytes in BIOS ROM file.
-11 or // F5	Unsupported BIOS ROM file version.
-12 or // F4	V0.10 must fit ROM size and address within 1MB.
-13 or // F3	V2.00 must have block descriptor table and image buffer.
-14 or // F2	Device table has too many entries.
-15 or // F1	Device table has unsupported flash type.
-16 or // F0	Combined SAVE or RESTORE attributes in BIOS file.
-17 or // EF	SAVE block without matching RESTORE block in BIOS file.
-18 or // EE	V0.10 must have JMP table for platform procs.
-19 or // ED	V2.00 must have OFFSET table for platform procs.
-20 or // EC	BIOS file found errors in command line parameters.
-21 or // EB	Part ID not found in table of supported parts.
-22 or // EA	Allocation for BIOS ROM image failed.
-23 or // E9	Open failed on BIOS ROM file.
-24 or // E8	Read failed on BIOS ROM file.
-25 or // E7	Copy of REAL to EXTENDED memory buffer failed.
-26 or // E6	File close failed on BIOS.WPH.
-27or // E5	Cannot flash if Memory Managers (e.g. EMM 386) is present.
-28 or // E4	Attempt to read flash memory ID failed.
-29or // E3	BIOS ROM file failed to return flash memory ID.
-30 or // E2	Could not find BCP SYS block in BIOS.WPH file image.
-31 or // E1	File has different BIOS part number.
-32 or // E0	File contains same version of BIOS ROM image.
-33 or // DF	Data written to flash does not match BIOS ROM image.
-34 or // DE	Write to flash memory failed.
-35 or // DD	Erase flash memory block failed.
-36 or // DC	VPP is not at expected level.
-37 or // DB	Erase sequence failed.
-38 or // DA	New DMI string is too large.
-39 or // D9	Specified BIOS ROM file is not for this system.
-40 or // D8	Allocation for DMI OEM string failed.
-41 or // D7	No space for specified DMI OEM string in BIOS ROM.
-42 or // D6	DMI OEM strings require BCP DMI 0.1+.
-43 or // D5	Could not find BCP DMI block in BIOS ROM file image.

Error Codes	Error Message
-44 or // D4	Cannot flash if Memory Managers (e.g.HIMEM) is present.
-45 or // D3	BIOS ROM file maybe corrupt (checksum not zero).
-46 or // D2	BIOS ROM file size doesn't match flash part size.
-47 or // D1	DMI system and chassis strings require BCP DMI 2.1+.
-48 or // D0	BIOS ROM file is older than (or same as) BIOS ROM image.
-49 or // CF	Platform signature not found in the interface.
-50 or // CE	Device descriptor signature not found in the interface.
-51 or // CD	Part table signature not found in the interface.
-52 or // CC	Invalid part count found in the interface.
-53 or // CB	Invalid text descriptor size found in the interface.
-54 or // CA	Invalid part descriptor size found in the interface.
-55 or // C9	Cannot flash when DOSKEY is present.
-56 or // C8	Duplicate device support found in the interface.
-57 or // C7	Program terminated due to command line option.

Index of PQA Diagnostic Error Code, Message

Error Code	Message	Action in Sequence
01XXX	CPU or main board error	Reload BIOS default setting. System board
02XXX	Memory error	DIMM System board
03XXX	Keyboard error	Reset Keyboard Keyboard System board
04XXX	Video error	System board
05XXX	Parallel Port error	System board
06XXX	Serial port error	System board
07XXX	Diskette drive error	Diskette drive System board
08XXX	Hard disk error	Reload BIOS default setting Hard disk System board
09XXX	CD-ROM error	Reset CD-ROM cable CD-ROM drive System board
10XXX	Co-processor error	System board
11XXX	Pointing device error	Reset Keyboard Keyboard System board
12XXX	Cache test error	System board

Jumper and Connector Locations

Top View

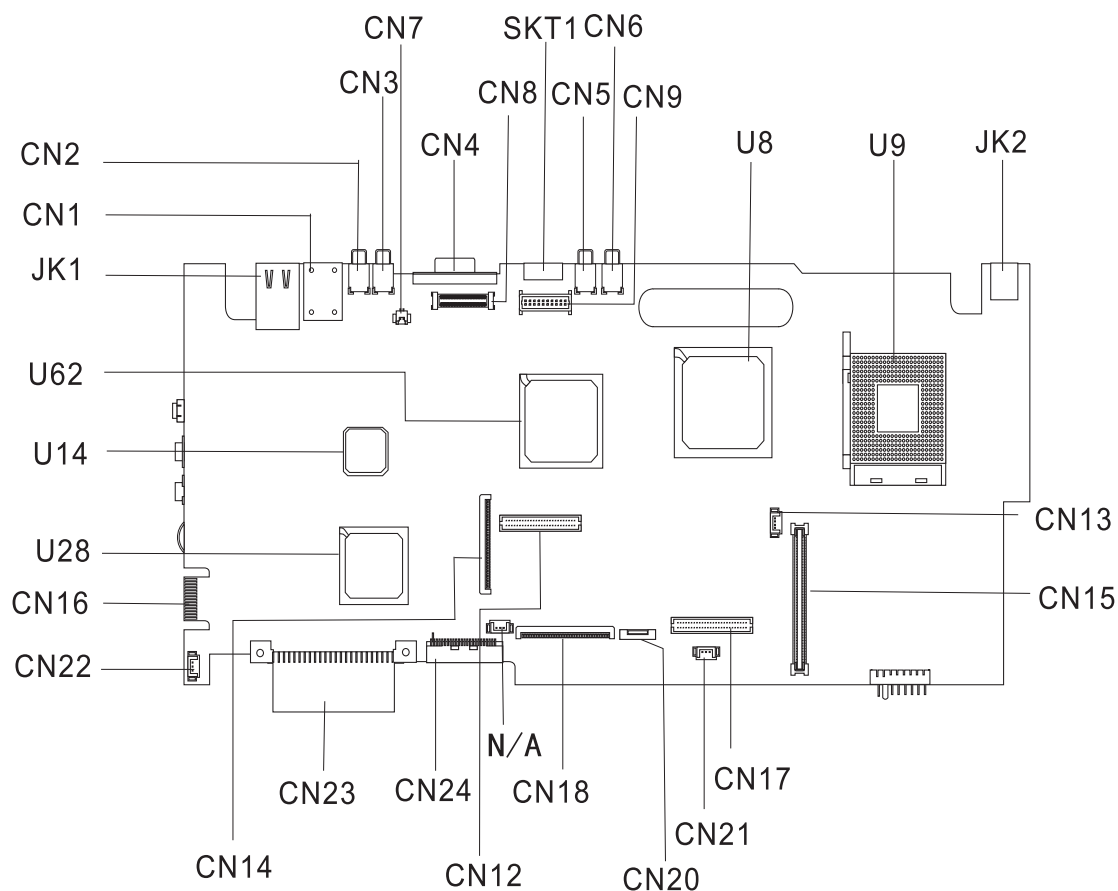

PCB No. 02222-SB

CN1	Modem Port	CN17	DC to DC Connector
CN2	USB Port	CN18	Keyboard Connector
CN3	USB Port	CN20	Touchpad Connector
CN4	VGA Port	CN21	RTC Connector
CN5	USB Port	CN22	Speaker Connector
CN6	USB Port	CN23	Primary IDE Connector
CN7	Launch Board Cable Connector	CN24	Secondary IDE Connector
CN8	LCD Monitor Connector	SKT1	S-Video Connector
CN9	Inverter Connector	U8	SiS648FX (North Bridge)
CN10	Mini-PCI Connector	U9	CPU Socket
CN12	DC to DC Connector	U14	Super IO Controller (PC87392V JG)
CN13	Fan Connector	U28	SiS963 (South Bridge)

CN14	Floppy Diskette Drive Connector	U62	VGA Chip (Radeon 9000)
CN15	Cardbus Connector	JK1	LAN Port
CN16	Debug Board (Golden Finger)	JK2	DC-in Port
N/A	FAN Connector		

Bottom View

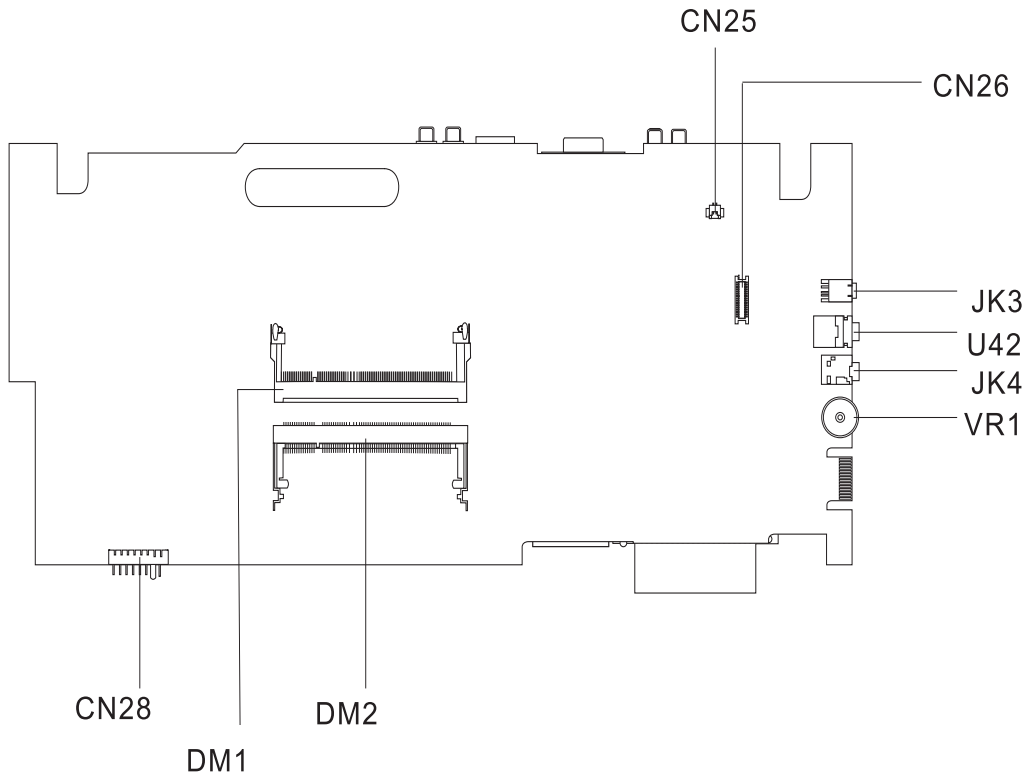

CN25	Modem Cable Connector	JK4	Line-in Port
CN26	Modem Connector	VR1	Volume Controller
CN28	Battery Connector	DM1	Memory Slot 1
JK3	IEEE 1394 Port	DM2	Memory Slot 2
U42	Speaker out Port		

CN27 Jumper Settings

CN27 Jumper setting:

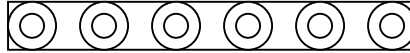

Pin6

Pin1

1-2 Clear RTC

3-4 Check Password

5-6 Boot block

Pin	Define
1	VCC RTC S5
2	GND
3	CHK PW
4	GND
5	BOOTBLOCK#
6	GND

NOTE: 1. CN27 is below DM2 socket.

FRU (Field Replaceable Unit) List

This chapter gives you the FRU (Field Replaceable Unit) listing in global configurations of the product. Refer to this chapter whenever ordering for parts to repair or for RMA (Return Merchandise Authorization).

IMPORTANT: Please note WHEN ORDERING FRU PARTS, that you should check the most up-to-date information available on your regional web or channel. For whatever reasons a part number change is made, it will not be noted in the printed Service Guide. For -AUTHORIZED SERVICE PROVIDERS, you may have a DIFFERENT part number code to those given in the FRU list of this printed Service Guide. You MUST use the local FRU list provided by your regional office to order FRU parts for repair and service of customer machines.





NOTE: To scrap or to return the defective parts, you should follow the local government ordinance or regulations on how best to dispose it, or follow the rules set by your regional office on how to return it.

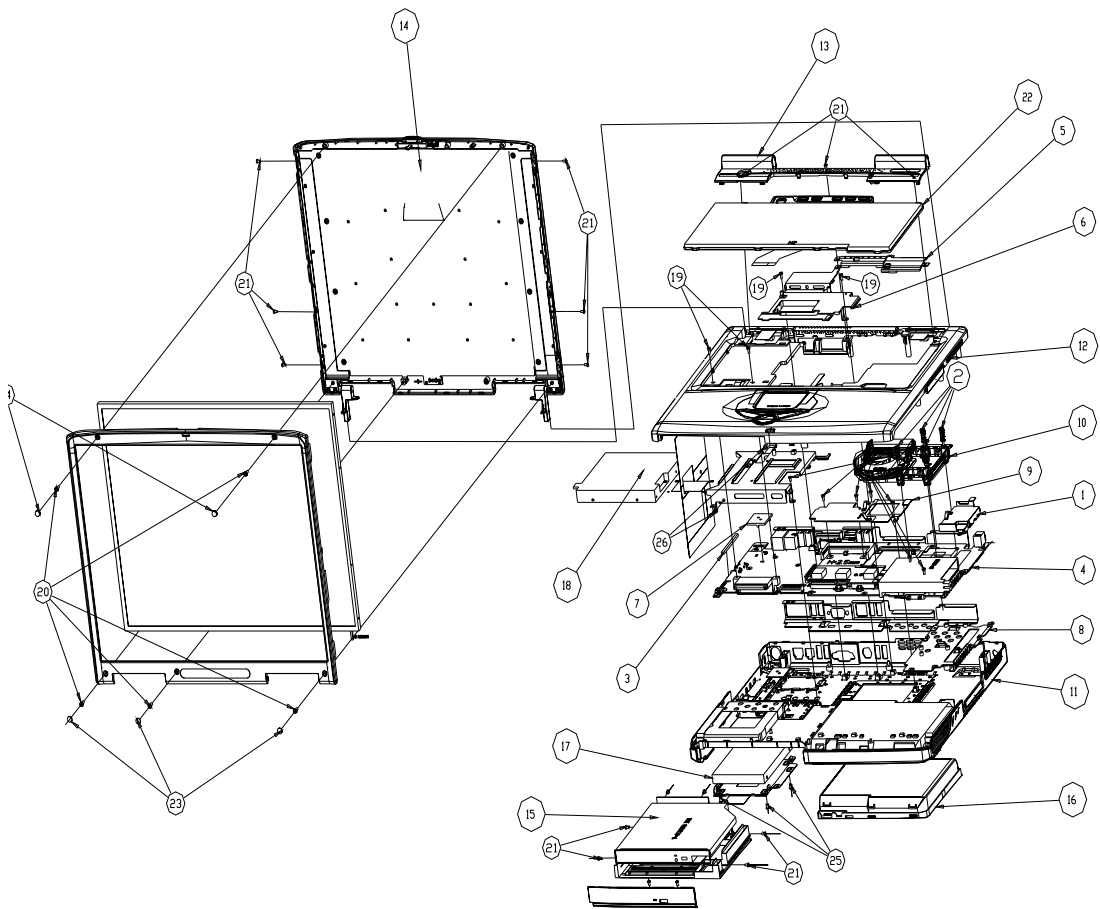

NOTE: The number indicates the location shown on exploded diagram or "NS" indicates "Not shown" on it.



Exploded Diagram







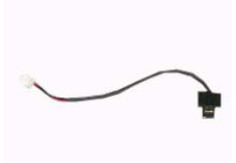



Picture	No.	Partname	Descripton
CPU / Processor			
	NS	INTEL PENTIUM 4 NORTHWOOD 3.2GHZ 512K 800FSB SL6WG	INTEL P4 3.2G 512K 800FSB
Memory			
	NS	MEMORY SO-DIMM DDR266/256MB/ 0.14U /INFINEON HYS64D32020 GDL- 7-B	SO-DDR 256MB HYS64D32020 GDL-7-B 32MX8X8 INFINEON
	NS	MEMORY SO-DIMM DDR266/256MB/ 0.14U /NANYA NT256D64SH8B0GM- 75B	SO-DIMM DDR266 256MB NT256D64SH8B0GM-75B (0.14U)
	NS	MEMORY SO-DIMM DDR266/256MB/ 0.14U /MICRO MT8VDDT3264HDG- 265C3	SO-DIMM DDR 256MB MT8VDDT3264HDG-265C3
LCD			
	NS	LCD MODULE 15" TFT XGA AU B15G0XG01 V.2	ASSY 15" LCD XGA SPWG - AU
	NS	LCD 15" TFT XGA AU B150XG01 V.2	LCD 15"XGA TFT AU/B150XG01 V.2
Heatsink			
	10	CPU HEATSINK MODULE W/FAN	ASSY HEATSINK COMET
	09	VGA THERMAL PLATE W/O FAN	ASSY PLATE THERMAL VGA TOUCAN3
	NS	ASSEMBLY DC CHARGER PLATE	ASSY DC-CHARGER PLATE TOUCAN3

Picture	No.	Partname	Descripton
	01	CPU HEATSINK PLATE	ASSY CPU THERMAL PLATE H2.1
Main board			
	NS	MAINBOARD TOUCAN3 W/O CPU W/ DC CHARGER BOARD&IO BRACKET&MODEM&MODEM CABLE&POWER CABLE&RTC BATTERY	TOUCAN2 PIV MB-1 W/O CPU
Boards			
	NS	TOUCH PAD BOARD	TOUCHPAD SYNAPTICS/ TM41PDS357
	NS	LAUNCH BOARD	H2 LAUNCH BOARD
	NS	OPTICAL DRIVER BOARD	H2 CD ROM BOARD
"15" AMBIT T621194.12" data-bbox="123 776 276 788"/>	NS	INVERTER BOARD 14"/>"15" AMBIT T621194.12	INVERTER 14"/>"15" T621194.12





Picture	No.	Partname	Descripton
	NS	DC CHARGER BOARD	TOUCAN2 DC TO DC BD 02389-2
	NS	MODEM BOARD AMBIT T60M283.10	MODEM MDC AMBIT/T60M283.10
Cables			
	NS	POWER CORD 250V 3PIN UK	CORD 250V UK 3P K29081H5183BPD
		POWER CORD 3PIN ITALY	CORD H03VV-F 3G KCC DBO ITALY
		POWER CORD 3PIN SWISS	CORD H033V-F 3G DBO SWISS
		POWER CORD 3PIN DENMARK	CORD H033V-F 3G DBO DENMARK
		POWER CORD 3PIN 250V AUST	CORD 250V AUS 3P K14081G5183BP
		POWER CORD 125V 3PIN US	CORD 125V UL 3P K01081B1183WP
		POWER CORD 125V 3PIN JAPAN	CORD VCTF 3C 7A125V K4A081 T-M
		POWER CORD 3PIN CHINA	CORD H05VV-F 10A250V K17081HG1
		POWER CORD 3PIN KOREAN	CORD VCTF 3G SP-023 7A250V KOR
		POWER CORD 220V EUR 3PIN CONTINENTAL	CORD H05VV-F 3G K15081H5183BPL
		TOUCHPAD CABLE	CABLE TOUCHPAD FPC H2 ASP
	NS	FDD FPC CABLE	CABLE FDD FPC H2
	NS	INVERTER CABLE	CABLE INVERTER H2 ASP
	NS	LCD COAX CABLE 15" FOR AU XGA	CABLE COAX 15"SPWG XGA AU ASP

Picture	No.	Partname	Description
	NS	POWER CABLE	CABLE POWER PCB H2
	NS	MODEM CABLE	WIRE MDC 2CONN 2P 55MM
Hard Disk Drive			
	17	HDD 40GB/2.5 IN./4200RPM/HITACHI EUCALYPTUS DK23EA-40	HITACHI EUCALYPTUS HDD 2.5 IN. 40G DK23EA/-40 4200RPM
		HDD 40GB/2.5 IN./4200RPM/FUJITSU HORNET MHS2040AT	FUJITSU HDD 2.5 IN. 40G HORNET 16L MHS2040AT 4200RPM
		HDD 60GB/2.5 IN./4200RPM/HITACHI EUCALYPTUS DK23EA-60	HITACHI EUCALYPTUS HDD 2.5 IN. 60G DK23EA/-60 4200RPM
		HDD 60GB/2.5 IN./4200RPM/FUJITSU HORNET 16L MHS2060AT	FUJITSU HDD 2.5 IN. 60G HORNET 16L MHS2060AT 4200RPM
DVD-RW Drive			
	NS	CD-ROM MODULE 24X MITSUMI	ASSEMBLY CD-ROM MODULE H2 ASP
	NS	CD-ROM 24X MITSUMI SR244W W/O BEZEL	CDROM 24X MITSUMI/SR244W W/O BEZEL
Combo Drive			
	15	DVD-RW MODULE 2X PANASONIC UJ-811B	ASSY DVD-RW MODULE 2X PANASONIC
	NS	DVD-RW DRIVE 2X PANASONIC UJ-811B W/O BEZEL	DVD MULTI UJ-811B COMET2 NO BZ
Keyboard			
	NS	KEYBOARD CHICONY MP-03203USD442 US	KB CHICONY MP-03203U4D4421 USI
		KEYBOARD CHICONY GERMAN	
		KEYBOARD CHICONY ITALIAN	
		KEYBOARD CHICONY MP-03206GBD4421 UK	KB CHICONY MP-03206GBD4421 UK
		KEYBOARD CHICONY FRENCH	
		KEYBOARD CHICONY MP-03206CDD4421 SWI	KB CHICONY MP-03206CDD4421 SWI
		KEYBOARD CHICONY SPANISH	
		KEYBOARD CHICONY PORTUGUESE	

Picture	No.	Partname	Descripton
FDD/Floppy Disk Drive			
	18	ASSY FDD MODULE 1.44M PANASONIC JU-226A033 REV.T	ASSY FDD MODULE MCI-T TOUCAN3
	NS	FDD 1.44M PANASONIC JU-226A033 REV.T	FDD 1.44 PANA/JU-226A033 REV.T
Adapter			
	NS	ADAPTER 120W 3PIN LITEON PA- 1121-02AC REV.A	ADT 120W 3P PA-1121-02AC REV.A
Battery			
	16	BATTERY MODULE 12CELL SONY W/ COVER	ASSY BTY(LI) MODULE TOUCAN 2
	NS	BATTERY 12 CELL LI-ION SONY	BATTERY PACK LI+12C 2AH SONY
	NS	RTC BATTERY	BTY COIN 3V CR2032WKA2 210MAH
Case/Cover/Bracket Assembly			
	NS	BATTERY COVER	ASSY COVER BATTERY H2 ASP

Picture	No.	Partname	Descripton
	NS	HDD BRACKET	ASSEMBLY HDD BRACKET
	5	KEYBOARD BRACKET	ASSEMBLY KEYBOARD BRACKET
	12	UPPER CASE W/ TOUCH PAD MODULE	ASSY UPPER CASE H2 ASP
	NS	TOUCHPAD HOLDER	COVER TOUCHPAD FRAME H2 ASP
	11	LOWER CASE W/ DIMM COVER, MODEM COVER & SPEAKER MODULE	ASSY LOWER TOUCNA3
	NS	MODEM DOOR W/ SCREW	ASSEMBLY MDC DOOR H2 ASP
	NS	DIMM DOOR W/ SCREW	ASSEMBLY COVER DIMM TOUCAN3
	13	MIDDLE COVER W/ LANUCH BOARD, NAME PLATE & POWER BUTTON	ASSEMBLY MIDDLE COVER H2 ASP

Picture	No.	Partname	Descripton
	NS	OPTICAL DRIVER HOLDER	ASSY CD-ROM CHASSIS H2 ASP
	NS	CD-ROM BEZEL FOR MITSUMI	ASSY CD-ROM BEZEL H2 ASP
	NS	COMBO BEZEL FOR MATSUSHITA	ASSEMBLY COMBO BEZEL H2 ASP
	NS	FDD HOLDER	ASSEMBLY BRACKET FDD INSERTION
	NS	LCD BEZEL W/ ICON LABEL	ASSY 15.1" LCD BEZEL H2 ASP
	NS	LCD PANEL W/ HINGE, LATCH & LOGO	ASSY LCD PANEL H2 ASP
	NS	HINGE PACK	HINGE PACK
	08	I/O BRACKET	ASSY IO BRACKET COMET

Picture	No.	Partname	Descripton
	NS	PCMCIA SLOT	CONN CARDBUS SKT C-1565338 ST
FAN			
	NS	FAN FOR VGA PLATE	FAN SINK TOUCAN 3
Speaker			
	NS	SPEAKER SET (L/R)	SPK LEFT 1W 4OHM 71DB 50MM
Miscellaneous			
	NS	TOUCHPAD BUTTON	BUTTON TOUCHPAD H2 ASP
	NS	TOUCHPAD SCROLL KEY	COVER SCROLL KEY H2 ASP
	NS	NAME PLATE	LBL NAME PLATE 40*7 H2(ASPIRE)
	NS	LOGO PLATE	PLATE LOGO-2,H2-ASPIRE,50*19.7
	NS	ICON LABEL	LBL ICON PLT 94*9.5 H2(ASPIRE)
	23	SCREW CAP LOWER	MYLAR SCREW BEZEL H2 ASP
	24	SCREW RUBBER UPPER	SCREW RUBBER UPPER
Screws			
	NS	SCREW	SCW HEX NYL I#R-40/O#4-40 L5.5
	NS	SCREW	SCRW TAP FLT M2.5*L18 ZN
	NS	SCREW	SCREW MACH FLAT M2*L4 NI
	19	SCREW	SCREW M2L5 BH MSN+N
	NS	SCREW	SCREW
	26	SCREW	SCREW M2.5*4L(NYLOCK)BLACK ZN
	20	SCREW	SCREW M2.5X6
	25	SCREW	SCREW M3x4(86.9A524.4R0)
	21	SCREW	SCRW M2*4 WAFER NI

Picture	No.	Partname	Descripton
	NS	SCREW	SCREW TAP FLT M1.7*3*L3 B/ZN

Model Definition and Configuration

Model Number Definition

Model Number	LCD	CPU	Memory	HDD	CD/DVD	Battery
Aspire 1606LC	15" XGA TFT	DTP4-3.2GHz	2x256MB DDR SDRAM	40GB Ultra ATA100 HDD	24xCDRW+DVD	Li-ion
Aspire 1606LM	15" XGA TFT	DTP4-3.2GHz	2x256MB DDR SDRAM	60GB Ultra ATA100 HDD	DVD-RW	Li-ion

Test Compatible Components

This computer's compatibility is a test plan released by Wistron Internal Testing Department. Once the final report is available, this chapter will be revised accordingly.

Microsoft Windows XP Environment Test

Item	Specifications
Processor	Intel P4 Northwood processor , 3.06GHz
Memory	DDR DIMM Nan-Ya 356MB
LCD	AU-15" SXGA B150PG01V0
Hard Disk Drive	Fujitsu -40G MHS2040AT
Battery	Sony Li-Ion Battery (12 cells)
Adapter	Liteon DAT 120W
Inverter	Ambit
Network Adapters	
LAN Ethernet'	IBM EtherJet CardBus Adapter 10/100 IBM EtherJet PC Card (10Base-T) Intel EtherExpress Pro/100 Mobile Adapter Xircom CardBus Ethernet 10/100 32 Bit Xircom RealPort CardBus Ethernet 10/100 3Com EtherLink III
Multifunction Card (Combo)	3Com MegaHertz 10/10 LAN + 56K Modem PC CArd Xircom CardBus Ethernet 10/100 + Modem 56 Xircom RealPort CardBus Ethernet 10/100 + Modem 56 IBM 10/100 EtherJet CardBus Real Port w/ 56K modem.
LAN Token Ring	IBM Turbo 16/4 Token Ring IBM Token Ring 16/4 Adapter II Madge 16/4 Token Ring
Wireless LAN Card	Lucent Wireless LAN CardBus Adapter Intel Pro/Wireless LAN PC Card Proxim Skyline 802.11a Cardbus Card
Modem Adapters	3Com Megahertz 56K Modem PC Card Xircom CreditCard Modem 56 IBM 56K Double Jack Modem
ISDN	US Robotics Megahertz 128K ISDN Card IBM ISDN Card
I/O Peripheral	
I/O - Display	Acer 211c 21" Viewsonic PF790 19" Acer FP751 17" TFT LCD IBM 15" TFT LCD NEC Color Monitor 20" Mozo 17" TFT LCD (DVI)
I/O - Projector	NEC MultiSync MT-1040
I/O - USB Keyboard/Mouse	Chicony USB Keyboard Microsft Natural Keyboard Pro Acer Aspire USB mouse Logitech USB Wheel Mouse Microsoft IntelliMouse Optical USB Interface Logicool USB Mouse Logitech Coreless MouseMan Wheel USB Interface

Item	Specifications
I/O - USB (Printer/Scanner)	Epson Stylus Color 740 USB interface HP DeskJet 880C USB interface Canon CanonScan D1250 (USB 2.0, JP OS only) HP ScanJet 3300C Color Scanner
I/O - USB (Speaker/Joystick)	Aiwa Multimedia Digital Speaker Microsoft SideWinder Precision Pro Joystick Logitech Wingman RumblePad
I/O - USB Camera	Intel Easy PC Camera Logitech QuickCam Express Internet Logitech QuickCam Home PC Video Camera
I/O - USB Storage Drive	Logitech CDRW +DVDROM combo USB interface Iomega USB Zip 250MB Plextor Burn-Proof CDRW (USB 2.0) Fujitsu MO-1300 1.3G (USB 2.0) Fujitsu 20GB HDD (USB 2.0) Sony DVD-ROM (USB 2.0) IBM 32MB USB Memory Key
I/O - USB Flash Drive	IBM 32MB USB Memory Key Apacer USB Handy Drive 32MB Apacer USB Handy Driver 256MB
I/O - USB Hub	Belkin 4 Port USB Hub Eizo I Station USB Hub Elecom USB Hub 4 Port Sanwa USB Hub 4 Port 4 Port Hub USB 2.0
I/O - 1394 Storage Drive	Logitech Firmware CDRW + DVDROM Combo Buffalo Firewire HD I.LINK 20GB I-O Data Firewire HD I.LINK 30GB Lacie Firewire HD 20G 7200RPM EXT-K525
I/O - 1394 Camera	Sony DV DCR-TRV10
I/O Peripheral List - TV (NTSC/PAL)	Sony 29" Trinitron KV-XA29N90
PCMCIA	
PCMCIA - ATA	IBM Microdrive 340MB IBM Microdrive 1G Iomega Click! 40MB Sony Memory Stick 64MB Sandisk Flash Card 20MB
PCMCIA - USB 2.0	DTK USB 2.0 Port CardBus Host Controller Adaptec USB2 Connect
PCMCIA - 1394	Buffalo 1394 Interface Cardbus I-O Data 1394 Interface Cardbus
PCMCIA - Bluetooth	Toshiba Bluetooth PC Card
PCMCIA - SCSI Card	Adaptec 1480A or B SCSI CB New Media Bus Toaster SCSI II

Online Support Information

This section describes online technical support services available to help you repair your Acer Systems.

If you are a distributor, dealer, ASP or TPM, please refer your technical queries to your local Acer branch office. Acer Branch Offices and Regional Business Units may access our website. However some information sources will require a user i.d. and password. These can be obtained directly from Acer CSD Taiwan.

Acer's Website offers you convenient and valuable support resources whenever you need them.

In the Technical Information section you can download information on all of Acer's Notebook, Desktop and Server models including:

- Service guides
- User's manuals
- Training materials
- Main manuals
- Bios updates
- Software utilities
- Spare parts lists
- Chips
- TABs (Technical Announcement Bulletin)

For these purposes, we have included an Acrobat File to facilitate the problem-free downloading of our technical material.

Also contained on this website are:

- Detailed information on Acer's International Traveller's Warranty (ITW)
- Returned material authorization procedures
- An overview of all the support services we offer, accompanied by a list of telephone, fax and email contacts for all your technical queries.

We are always looking for ways to optimize and improve our services, so if you have any suggestions or comments, please do not hesitate to communicate these to us.

A

AC Adapter 28
 AFLASH Utility 50
 Audio 19

B

Battery 26
 battery pack
 charging indicator 11
 BIOS 19
 package 19
 ROM size 19
 ROM type 19
 vendor 19
 Version 19
 BIOS Setup Utility 34
 BIOS Supports protocol 19
 BIOS Utility 34
 Load Default Settings 49
 Navigating 36
 System Information 37
 System Security 44
 Board Layout 4
 Bottom View 5
 Top View 4
 brightness
 hotkeys 16

C

Cache
 controller 19
 size 19
 caps lock
 on indicator 11
 CardBus 26
 Chipsets 19
 computer
 on indicator 11
 contrast
 hotkeys 16
 Controllers 19
 Core logic 19
 CPU
 core voltage 19
 I/O voltage 19
 package 19
 type 19

D

DC-AC LCD Inverter 27
 DC-DC/Charger 26
 DIMM 20
 Combinations 20
 package 20
 Speed 20
 voltage 20
 Disassembly
 Machine 52
 Disassembly Flowchart 54
 Display 1
 display
 hotkeys 15
 Display Standby Mode 29
 DMA Channel Assignment 32
 DVD-ROM Interface 22

E

Environmental Requirements 29
 Error Symptom-to-Spare Part Index 85
 External CD-ROM Drive Check 81
 External Diskette Drive Check 81

F

Features 1
 Flash Utility 50
 Floppy Disk Drive Interface 21
 FRU 106
 FRU (Field Replaceable Unit) List 106

H

Hard disk 19, 21
 Hard Disk Drive Module
 Disassembly 58
 Hard Disk Standby Mode 29
 Hardware Specifications and Configurations 19
 HDD 19, 21
 Hibernation Mode 29
 Hibernation mode
 hotkey 15
 Hot Keys 15

I

I/O Address Map 31

Indicators 11
Intermittent Problems 96
IRQ Assignment Map 32

J

Jumper and Connector Locations
 Bottom View 104
 Top View 102, 104

K

Keyboard 19, 26
Keyboard or Auxiliary Input Device Check 82

L

L2 cache 19
LCD 27

M

Machine Disassembly 52
Mechanical Specification 29
media access
 on indicator 11
Memory
 Address Map 30
Memory Address Map 30
Memory Check 82
Modem 21

N

Notebook Manager
 hotkey 15
num lock
 on indicator 12

O

Online Support Information 124

P

Panel 5
 Bottom 10
 right 8
Password Setting
 Hard Disk Password 46
 Power-On Password 46
 Setup Password 46
PC Card 11, 26
PCMCIA 26
Power Management 29
Power management 2

Power System Check 82
 Battery Pack 84
 Power Adapter 83

R

Removing the Battery Pack 56
RMA 106
RTC 19

S

Second Level Cache 19
speakers
 hotkey 16
Standby Mode 29
Super I/O 19
System
 Block Diagram 3
 Layout 4
System Check Procedures 81
System Diagnostic Diskette 50, 80
System Memory 19
System Utilities 34

T

Temperature 29
Test Compatible Components 120
Touchpad 19
touchpad
 hotkey 16
Touchpad Check 84
Troubleshooting 80

U

Undetermined Problems 97
USB 26
utility
 BIOS 34

V

Video 25
 Resolutions 25
Video controller 19

W

Windows XP Environment Test 121

