

Acer Aspire 1650 Series

Service Guide

Service guide files and updates are available on the ACER/CSD web; for more information, please refer to <http://csd.acer.com.tw>

PRINTED IN TAIWAN

Revision History

Please refer to the table below for the updates made on Aspire 1650 service guide.

Date	Chapter	Updates
2006/8/18	Chapter 2	Update BIOS specification.

Copyright

Copyright © 2005 by Acer Incorporated. All rights reserved. No part of this publication may be reproduced, transmitted, transcribed, stored in a retrieval system, or translated into any language or computer language, in any form or by any means, electronic, mechanical, magnetic, optical, chemical, manual or otherwise, without the prior written permission of Acer Incorporated.

Disclaimer

The information in this guide is subject to change without notice.

Acer Incorporated makes no representations or warranties, either expressed or implied, with respect to the contents hereof and specifically disclaims any warranties of merchantability or fitness for any particular purpose. Any Acer Incorporated software described in this manual is sold or licensed "as is". Should the programs prove defective following their purchase, the buyer (and not Acer Incorporated, its distributor, or its dealer) assumes the entire cost of all necessary servicing, repair, and any incidental or consequential damages resulting from any defect in the software.

Acer is a registered trademark of Acer Corporation.

Intel is a registered trademark of Intel Corporation.

Pentium and Pentium II/III are trademarks of Intel Corporation.

Other brand and product names are trademarks and/or registered trademarks of their respective holders.

Conventions

The following conventions are used in this manual:

SCREEN MESSAGES	Denotes actual messages that appear on screen.
NOTE	Gives bits and pieces of additional information related to the current topic.
WARNING	Alerts you to any damage that might result from doing or not doing specific actions.
CAUTION	Gives precautionary measures to avoid possible hardware or software problems.
IMPORTANT	Reminds you to do specific actions relevant to the accomplishment of procedures.

Preface

Before using this information and the product it supports, please read the following general information.

1. This Service Guide provides you with all technical information relating to the BASIC CONFIGURATION decided for Acer's "global" product offering. To better fit local market requirements and enhance product competitiveness, your regional office MAY have decided to extend the functionality of a machine (e.g. add-on card, modem, or extra memory capability). These LOCALIZED FEATURES will NOT be covered in this generic service guide. In such cases, please contact your regional offices or the responsible personnel/channel to provide you with further technical details.
2. Please note WHEN ORDERING FRU PARTS, that you should check the most up-to-date information available on your regional web or channel. If, for whatever reason, a part number change is made, it will not be noted in the printed Service Guide. For ACER-AUTHORIZED SERVICE PROVIDERS, your Acer office may have a DIFFERENT part number code to those given in the FRU list of this printed Service Guide. You MUST use the list provided by your regional Acer office to order FRU parts for repair and service of customer machines.

System Specifications

Features

This computer was designed with the user in mind. Here are just a few of its many features:

Performance

- Intel® 915GM PCI Express chipset
- Intel® Pentium® M processor 725A/730/740/750/760/770/780 (2MB L2 cache, 1.6 GHz, 400 MHz FSB) or higher
- CPU Package is uFPGA 478 Package
- Integrated Intel® PRO/Wireless 2200BG network connection (dual-mode 802.11b/g) Wi-Fi CERTIFIED™ solution

Memory

- 256MB or 512MB of DDRII 400/533
- Upgradeable to 2GB Memory by Dual channels of SODIMM
- 512KB flash ROM BIOS

Display and video

- Thin-Film Transistor (TFT) displaying at:
 - 15.0" XGA TFT LCD, supporting 1024x768 pixel resolution
 - 15.4" WXGATFT LCD, supporting 1280x800 pixel resolution
- Acer Crystal IBrite (for selected models)
- ATI MOBILITY™ RADEON® X300 with 64/128 MB of GDDR1** VRAM with ATI POWERPLAY™ 5.0, Microsoft DirectX 9.0, PCI Express™ and DualView™
- Simultaneous LCD and CRT display support
- Dual independent display
- External resolution/refresh rate
 - 2048x1536: 75/70/66/60 Hz
 - 1600x1200: 120/100/92/85/76/75/70/66/65/60/58/52 Hz
 - 1280x1024: 160/120/100/90/85/75/74/70/60 Hz
 - 1024x768: 200/160/150/120/100/90/85/75/72/70/60 Hz
 - 800x600: 160/120/100/90/85/75/72/70/60 Hz

Audio

- Dual speakers and one internal microphone
- S/PDIF support
- MS-Sound Compatible
- Separate audio ports for headphone-out, line-in and microphone-in devices

Storage

- 40 GB and above E-IDE hard disk (2.5", 9.5mm, UltraDMA-100)
- Optical drive options: tray type DVD-Dual double-layer or DVD/CD-RW combo
 - Tray type DVD-Dual double-layer drive; Read: 8X DVD-ROM, 6X DVD-R, 6X DVD+RW, 6X DVD-RW, 6X DVD+R, 6X DVD+R DL (double-layer), 24X CD-RW, 24X CD-R; Write: 24X CD-R, 10X CD-RW, 8X DVD+R, 8X DVD-R, 4X DVD+RW, 2.4X DVD+R DL (double-layer), 4X DVD-RW
 - DVD/CD-RW combo drive; Read: 24X CD-RW, 24 CD-R, 24X CD-ROM, 8X DVD+R, 8X DVD-R, 8X DVD-ROM, 4X DVD+RW, 4X DVD-RW; Write: 24X CD-RW, 24X CD-R

Communication

- 56Kbps V.90/92 with PTT approval; Wake-on-ring ready
- 10/100Mbps Fast Ethernet; wake-on-LAN ready
- WLAN: integrated Intel® PRO/Wireless 2200BG network connection (dual-mode 802.11b/g) Wi-Fi CERTIFIED™ solution, supporting Acer SignalUp wireless technology
- WPAN: integrated Bluetooth®

I/O Ports

- One Type II PC Card slot
- One RJ-11 phone jack (V.92, 56Kbps modem)
- One RJ-45 network jack
- One DC-in jack (AC adapter)
- One external monitor port
- One headphones/speaker/headphone-out jack
- Microphone/line-in jack
- Three USB 2.0 ports

Battery

- 4-cell of Li-ion battery pack, (2000mAh,32W) different from TravelMate 4020**
- 65W AC adaptor 19V 3.42A

Weight (with battery)

- 3.0 kg (6.6 lbs.)

Dimensions

- 364(W) x 279(D) x 33.9/38.9(H) mm (14.3 x 11 x 1.3/1.5 inches)

Environment

- Temperature
 - Operating: 5° C ~ 35° C
 - Non-operating: -20° C ~ 65° C
- Humidity (non-condensing)Operating: 20% ~ 80% RH

Rear View

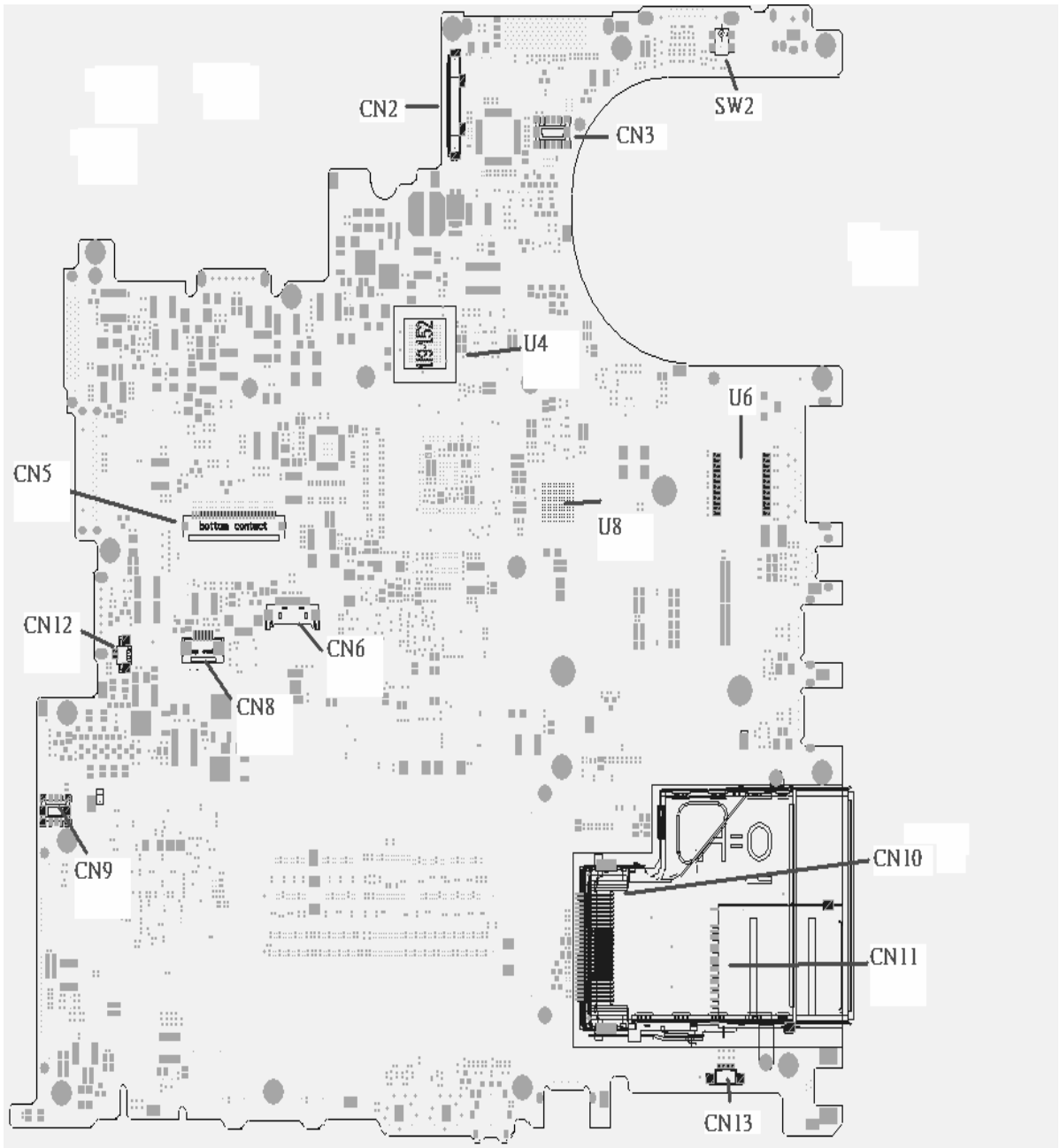

ITEM	DESCRIPTION	ITEM	DESCRIPTION
CN2	LCD Connector	CN14	DC JACK
CN3	LED board connector	CN15	CRT connector
SW2	Lid switch	CN16	Docking connector
CN10	express card connector	CN17	Battery connector
CN11	4 IN 1 connector	CN18	Fix ODD connector
CN13	Speaker connector	CN21	Swap ODD connector
CN9	MD board connector	CN24	2nd Battery connector
CN12	INT MIC connector	CN30	PATA HDD connector
CN5	Keyboard connector	CN31	SATA HDD connector
CN6	BT connector	CN36	Line IN connector
CN8	TP connector	CN34	MIC IN connector
U4	VGA RAM	CN35	Line out/SPDIF connector
U8	VGA RAM	CN33	USB connector
U6	LAN transformer	CN32	1394 connector
CN28	PCMCIA connector	CN26	USB connector
CN25	USB connector	CN23	S video connector
CN20	RJ45/RJ11 connector	CN19	Fan connector
CN22	MINI PCI connector	U31	CPU
U30	EC	U29	VGA Chp
U34	North Bridge	U38	South Bridge
U25	VGA RAM	U28	VGA RAM
U24	BIOS ROM		

Outlook View

A general introduction of ports allow you to connect peripheral devices, as you would with a desktop PC.







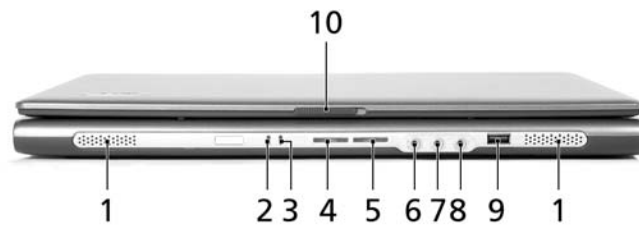

Open View



#	Item	Description
1	Display screen	Also called Liquid-Crystal Display (LCD), displaying computer output.
2	Microphone	Internal microphone for sound recording.
3	Keyboard	For entering data into your computer.
4	Palmrest	Comfortable support area for your hands when you use the computer.
5	Click buttons (Left, center and right)	The left and right buttons function like the left and right mouse buttons; the center button serves as a 4-way scroll button.
6	Touchpad	Touch-sensitive pointing device which functions like a computer mouse.
7	Status indicators	Light-Emitting Diodes (LEDs) that turn on and off to show the status of the computer's functions and components.
8	Easy-launch buttons	Buttons for launching frequently used programs.
9	Power button	Turns the computer on and off.

Front Panel



#	Icon	Item	Description
1		Speakers	Left and right speakers deliver stereo audio output.
2		Power indicator	Lights when the computer is on.
3		Battery indicator	Lights when the battery is being charged.
4		Bluetooth communication button/indicator	Press to enable/disable Bluetooth function. Lights to indicate the status of Bluetooth communications.
5		Wireless communications button/indicator	Press to enable/disable Wireless function. Lights to indicate the status of wireless LAN communications. (manufacturing option)
6		Line-in jack	Accepts audio line-in devices (e.g., audio CD player, stereo walkman).
7		Microphone jack	Accepts inputs from external microphones.
8		Speaker/Line-Out/Headphone jack	Connects to audio line-out devices (e.g., speakers, headphones).
9		USB 2.0 port	Connects to Universal Serial Bus (USB) 2.0 devices (e.g., USB mouse, USB camera).
10		Latch	Locks and releases the lid.

Left View

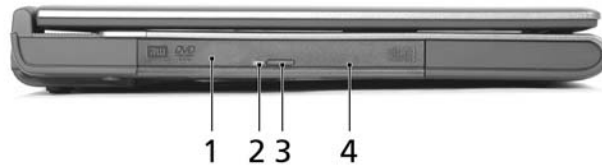



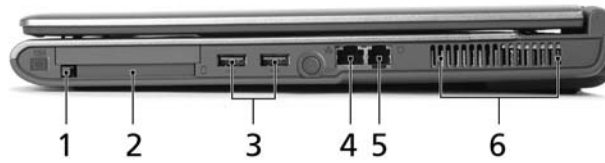

#	Item	Description
1	Optical drive	Internal optical drive; accepts CDs or DVDs depending on the optical drive type.
2	LED indicator	Lights up when the optical drive is active.
3	Optical drive eject button	Ejects the optical drive tray from the drive.
4	Emergency eject hole	Ejects the optical drive tray when the computer is turned off

NOTE: The positions of the AcerMedia indicator, eject button and emergency eject hole may differ depending on the optical drive module installed.

Right View



#	Icon	Item	Description
1		PC Card slot eject button	Ejects the PC Card from the slot.
2		PC Card slot	Connects to one Type II CardBus PC Card.
3		Two USB 2.0 ports	Connect to Universal Serial Bus (USB) 2.0 devices (e.g., USB mouse, USB camera).
4		Ethernet (RJ-45) port	Connects to an Ethernet 10/100-based network (for selected models).
5		Modem (RJ-11) port	Connects to a phone line.
6		Ventilation slots	Enable the computer to stay cool, even after prolonged use.

Rear View



#	Icon	Item	Description
1		Power jack	Connects to an AC adapter.
2		External display port	Connects to a display device (e.g., external monitor, LCD projector).
3		Security keylock	Connects to a Kensington-compatible computer security lock.

Bottom View



#	Item	Description
1	Hard disk bay	Houses the computer's hard disk (secured with two screws).
2	Battery release latch	Unlatches the battery to remove the battery pack.
3	Battery bay	Houses the computer's battery pack.
4	Battery lock	Locks the battery in place.



#	Item	Description
5	Cooling fan	Helps keep the computer cool. NOTE: Do not cover or obstruct the opening of the fan.
6	Memory compartment	Houses the computer's main memory and Mini PCI Card.

Indicators

Your computer provides an array of three indicators located above the keyboard, in addition to four indicators positioned at the front of the palm rest area. These indicators show the status of the computer and its components.



The three indicators located above the keyboard provide the following status information:

Icon	Item	Description
	Caps Lock activity	Lights when Caps Lock is activated.
	Num Lock activity	Lights when Num Lock is activated.
	Media activity	Lights when the hard disk or optical drive is active.

NOTE: The keypad lock must be turned on to use the embedded numeric keypad.

Easy-launch buttons

The build-in touchpad is a PS/2 compatible pointing device that senses movement on its surface.

The cursor responds to your finger movements on the touchpad. In addition, the two click buttons provide the same functionality as a computer mouse, while the scroll key enables easy up and down scrolling in documents and web pages.

The touchpad is located in the middle of the palm rest area, providing maximum comfort and efficiency.

Touchpad

The build-in touchpad is a PS/2 compatible pointing device that senses movement on its surface.

The cursor responds to your finger movements on the touchpad. In addition, the two click buttons provide the same functionality as a computer mouse, while the scroll key enables easy up and down scrolling in documents and web pages.

The touchpad is located in the middle of the palm rest area, providing maximum comfort and efficiency.



Touchpad Basics

Use the touchpad as follows:



- Move your finger across the touchpad to move the cursor.
- Press the left **(1)** and right **(3)** buttons located on the edge of the touchpad to do selection and execution functions. These two buttons are similar to the left and right buttons on a mouse. Tapping on the touchpad is the same as clicking the left button
- Use the 4-way scroll **(2)** button to scroll up or down and move left or right a page. This button mimics your cursor pressing on the right scroll bar of windows applications.

Using the Keyboard

The full-sized keyboard includes an embedded numeric keypad, separate cursor keys, two Windows keys and twelve function keys.

Lock keys and embedded numeric keypad

The keyboard has four lock keys which you can toggle on and off.



The computer features three lock keys, each with its own status indicator light.

Lock Key	Description
Caps Lock	When Caps Lock is on, all alphabetic characters are typed in uppercase. Toggle on and off by pressing the Caps Lock key on the left side of the keyboard.
Num lock <Fn+F11>	When Num Lock is on, the embedded numeric keyboard can be used. Toggle on and off by pressing the Fn+  keys simultaneously.
Scroll lock <Fn+F12>	When Scroll Lock is on, the screen toggles up or down one line at a time when the up and down cursor control keys are pressed.









NOTE: Scroll Lock doesn't work in all applications. Toggle on and off by pressing the Fn+F12 keys simultaneously.

The embedded numeric keypad functions like a desktop numeric keypad. It is indicated by small characters located on the upper right corner of the keycaps. To simplify the keyboard legend, cursor-control key symbols are not printed on the keys.

Desired action	Num Lock on	Num Lock off
Number keys on embedded keypad	Type numbers in a normal manner	
Cursor-control keys on embedded keypad	Hold Shift while using cursor-control keys.	Hold Fn while using cursor-control keys.
Main keyboard keys	Hold Fn while typing letters on embedded keypad.	Type the letters in a normal manner.

Windows Keys

The keyboard features two keys that perform Windows-specific functions.

Key	Description
Windows logo key 	Pressed alone, this key has the same effect as clicking on the Windows Start button; it launches the Start menu. It can also be used with other keys to provide a variety of functions: <ul style="list-style-type: none">  + Tab (Activates the next Taskbar button)  + E (Opens the My Computer window)  + F1 (opens Help and Support)  + F (opens the Find: All Files dialog box)  + M (minimizes all windows)  + Windows icon + M (undoes the minimize all windows action)  + R (opens the Run dialog box)
Application key 	This key has the same effect as clicking the right mouse button; it opens the application's context menu.











Hot Keys

The computer employs hotkeys or key combinations to access most of the computer's controls like screen brightness, volume output and the BIOS utility.

To activate hot keys, press and hold the <Fn> key before pressing the other key in the hotkey combination.



Hot Key	Icon	Function	Description
Fn-F1	?	Hot key help	Displays help on hot keys.

Hot Key	Icon	Function	Description
Fn-F2		Acer eSetting	Launches the Acer eSettings in Acer eManager.
Fn-F3		Acer ePowerManagement	Launches the Acer ePowerManagement in Acer eManager.
Fn-F4		Sleep	Puts the computer in Sleep mode.
Fn-F5		Display toggle	Switches display output between the display screen, external monitor (if connected) and both.
Fn-F6		Screen blank	Turns the display screen backlight off to save power. Press any key to return.
Fn-F7		Touchpad toggle	Turns the internal touchpad on and off.
Fn-F8		Speaker toggle	Turns the speakers on and off.
Fn- 		Volume up	Increases the speaker volume.
Fn- 		Volume down	Decreases the speaker volume.
Fn- 		Brightness up	Increases the screen brightness.
Fn- 		Brightness down	Decreases the screen brightness

Special Keys

You can locate the Euro symbol and US dollar sign at the upper-center and/or bottom-right of your keyboard. To type:



The Euro symbol

1. Open a text editor or word processor.
2. Either directly press the **<Euro>** symbol at the bottom-right of the keyboard, or hold **<Alt Gr>** and then press the **<5>** symbol at the upper-center of the keyboard.

The US dollar sign

1. Open a text editor or word processor.
2. Either directly press the **<Dollar>** key at the bottom-right of the keyboard, or hold **<Shift>** and then press the **<4>** key at the upper-center of the keyboard.

NOTE: This function varies by the operating system version.





NOTE: Some fonts and software do not support the Euro symbol. Please refer to www.microsoft.com/typography/faq/faq12.htm for more information.

Using System Utilities

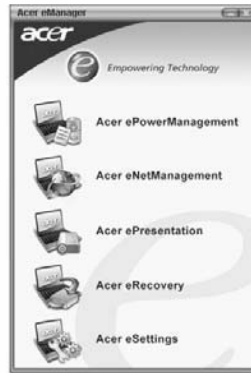
Acer eManager

Innovative Acer eManagement software is designed for easy access to frequently used functions. At the press of Acer Empowering Key, the Acer eManager user interface appears, featuring four main settings -- Acer eSetting, Acer ePresentation, Acer ePowerManagement and Acer eRecovery.



Icon	Item	Description
	Acer ePowerManagement	Provides a central location from which to control all your PC's power schemes and maximize battery life.
	Acer eNetManagement	Helps you to quickly and easily connect to networks in variety of location.
	Acer ePresentation	It takes the hassle out of making presentations.
	Acer eRecovery	It backs up your files preventing data loss in the event of a system crash.
	Acer eSetting	It is an easy way to manage the settings and security of your PC.

Launch Manager

Launch Manager allows you to set the two launch keys located above the keyboard.

You can access the Launch Manager by clicking on **Start, All Programs**, and then **Launch Manager** to start the application.

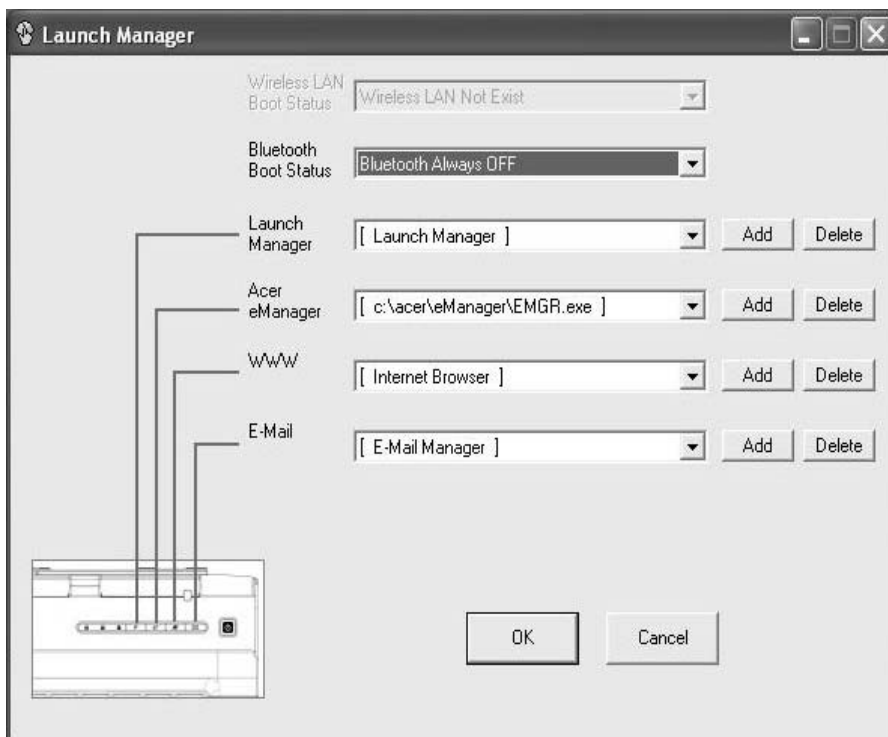

Hardware Specifications and Configurations

Processor

Item	Specification
CPU type	Intel® Pentium® M Processor at 1.5 ~2.13 GHz or higher Intel® Celeron® M Processor at 1.3~1.5 GHz or higher
CPU package	uFPGA 478
CPU core voltage	Depend on DVI
CPU I/O voltage	1.2V

System Board Major Chips

Item	Controller
System core logic	Intel® 915PM / ICH6-M Intel® 915GM / ICH6-M
Super I/O controller	KBC (97551), LPC interface
Audio controller	Conexant Codec
Video controller	ATI M22P
Hard disk drive controller	ICH6-M
Keyboard controller	KBC 97551
IrDA controller	SIO 87383
DVI controller	CH7307
PCMCIA/ card reader / 1394 controller	TI PCI7411
DDR-soDIMM controller	915PM/915GM

BIOS

Item	Specification
BIOS vendor	Phoenix
BIOS Version	Phoenix First BIOS
BIOS ROM type	Flash ROM
BIOS ROM size	512KB
BIOS package	32 lead of TSSOP
BIOS password control	Set by setup manual

L2 Cache

Item	
Cache controller	Built-in CPU
Cache size	2 MB
1st level cache control	Always enabled
2nd level cache control	Always enabled
Cache scheme control	Always enabled

System Memory

Item	Specification
Memory controller	915PM/915GM
Memory size	256MB/512MB
DIMM socket number	2
Supports memory size per slot	1024 MB
Supports maximum memory size	2GB
Supports DIMM type	DDRII SDRAM standard
Supports DIMM Speed	400/533 MHz
Supports DIMM voltage	1.8V
Memory module combinations	You can install memory modules in any combinations as long as they match the above specifications.

LAN Interface

Item	Specification
Supports LAN protocol	10/100 Mbps Fast Ethernet connection
LAN connector type	RJ45
Wireless LAN	InviLink. 802.11b/g dual-band tri-mode Wireless or 802.11 a/b/g dual-band tri-mode Wireless
LAN connector location	Right side

Modem/Bluetooth Interface

Item	Specification
Data modem data baud rate (bps)	56K ITU
Supports modem/bluetooth protocol	V.90/V.92 AC-Link modem with PTT approval Wake-on-Ring ready
Modem connector type	RJ11
Modem connector location	Right side
Bluetooth	Bluetooth 2.0 module (TravelMate 4020 is Bluetooth 1.2 module)

VGA

Item	Discrete
Chipset for suitable VGA type	ATI M229
Video RAM Size	64/128MB

USB Port

Item	Specification
USB compliancy level	2.0
OHCI	USB 2.0
Number of USB port	3
Location	Right Side *2 Front Side *1

Item	Specification
Audio Controller	AC' 97 Codec
Audio onboard or optional	Built-in
Mono or Stereo	Stereo
Resolution	20 bit stereo Digital to analog converter 18 bit stereo Analog to Digital converter
Compatibility	Microsoft PC99/2100, AC97 2.3 & WHQL/WLP2.0
Mixed sound source	CD
Sampling rate	48 KHz
Internal microphone	Yes
Internal speaker / Quantity	Yes / 2

PCMCIA Port

Item	Specification
PCMCIA controller	PCI7411
Supports card type	Type II
Number of slots	One type-II
Access location	Right Side
Supports ZV (Zoomed Video) port	No
Supports 32 bit CardBus	Yes

Keyboard

Item	Specification
Keyboard controller	KBC 97551
Keyboard vendor & model name	Standard keyboard w launch button embedded
Total number of keypads	<input type="checkbox"/> 88-89 keys Acer Fine Touch™ keyboard <input type="checkbox"/> with 5-degree curve
Touchpad with 4-way integrated scroll button	Yes
12 function keys	<input type="checkbox"/> four cursor keys <input type="checkbox"/> two Windows keys <input type="checkbox"/> Hotkey controls <input type="checkbox"/> embedded numeric keypad <input type="checkbox"/> international language support
Four easy-launch buttons	<input type="checkbox"/> Internet browser <input type="checkbox"/> email with LED <input type="checkbox"/> Empowering key <input type="checkbox"/> one user-programmable button
Two front access LED buttons	<input type="checkbox"/> WLAN LED button <input type="checkbox"/> Bluetooth LED button

Battery

Item	Specification
Vendor & model name	Panasonic/Sanyo
Battery Type	Li-ion
Pack capacity	65Wh
Cell voltage	3.7V/cell/2000mAh High discharge rate
Number of battery cell	8-cell(65W) 4-cell(32W)
Package configuration	
Pin 1 Pin 2	BATT+: Battery+, Battery Positive Terminal
Pin 3	ID : Identify Pin (Note 1)
Pin 4	B/I : Battery-In Pin
Pin 5	TS : Connect to Thermister
Pin 6	SMD : SMBus data interface I/O pin
Pin 7	SMC : SMBus clock interface I/O pin
Pin 8 Pin 9	GND : Battery Negative Terminal

LCD :15.4" WXGA

Item	Specification				
Vendor & model name	CMO N15411-L09	LPL LP154W01- A5	Hitachi TX39D85V C1FAA	Samsung LTN154X3- L01	QDI QDI15TL02- 01
Mechanical Specifications					
LCD display area (diagonal, inch)	15.4"	15.4"	15.4"	15.4"	15.4"
Display technology	TFT	TFT	TFT	TFT	TFT
Resolution	WXGA (1280*800)	WXGA (1280*800)	WXGA (1280*800)	WSXGA (1280*800)	WSXGA (1280*800)
Supports colors	16.7 million	16.7 million	16.7 million	16.7 million	16.7 million
Optical Specification					
Brightness control	keyboard hotkey	keyboard hotkey	keyboard hotkey	keyboard hotkey	keyboard hotkey
Contrast control	No	No	No	No	No
Suspend/Standby control	Yes	Yes	Yes	Yes	Yes
Electrical Specification					
Supply voltage for LCD display (V)	3.3	3.3	3.3	3.3	3.3
Supply voltage for LCD backlight (Vrms)	785	785	730	735	735

LCD:15"XGA

Item	Specifications				
Vendor & model name	AU B150XG02 V.2	LG LP150X08-A3	Samsung LTN150XB- L03-C00	Hitachi TX38D81VC1 CAB Rev.C	CMO N150X3-L07
Mechanical Specification					
LCD display area (diagonal, inch)	15"	15"	15"	15"	15"
Display technology	TFT	TFT	TFT	TFT	TFT
Resolution	XGA (1024*768)	XGA (1024*768)	XGA (1024*768)	XGA (1024*768)	XGA (1024*768)
Supports colors	16.7 million	16.7 million	16.7 million	16.7 million	16.7 million
Optical Specification					
Brightness control	keyboard hotkey	keyboard hotkey	keyboard hotkey	keyboard hotkey	keyboard hotkey
Contrast control	No	No	No	No	No
Suspend/ Standby control	Yes	Yes	Yes	Yes	Yes
Electrical Specification					
Supply voltage for LCD display (V)	3.3	3.3	3.3	3.3	3.3
Supply voltage for LCD backlight (Vrms)	785	785	730	735	735

AC Adapter

Item	Specification
Vendor & model name	Delta 3-pin, 19V 3.95A, 64W Hipro 3-pin, 19V 3.95A, 65W Lite-on 3-pin, 19V 3.95A, 60W
Details	65W Li-ion battery pack (8-cell) <ul style="list-style-type: none"> <input type="checkbox"/> 4-hour battery life (support intel GFX) <input type="checkbox"/> 3-hour battery life (support ATI X600) <input type="checkbox"/> 1.5-hour quick-charge, 3.5-hour charge-in use
Input Requirements	
Maximum input current (A, @100Vac, full load)	1.8A max@3.5A/100Vac and 240 Vac
Nominal frequency (Hz)	47 - 63

AC Adapter

Item	Specification
Frequency variation range (Hz)	47 - 63
Nominal voltages (Vrms)	90 - 264
Inrush current	The maximum inrush current will be less than 50A and 100A when the adapter is connected to 100Vac(60Hz) and 240Vac(50Hz) respectively.
Efficiency	High efficiency 85% minimum, at 100~240Vac AC input, full load, warm-up condition.
Output Ratings (CV mode)	
DC output voltage	Offers constant voltage 19.0V output source with 150W max output power capacity.
Noise + Ripple	300mvp-pmax (20MHz bandwidth) for resistor load
Output current	0 A (min.) 3.5A (max.)
Output Ratings (CC mode)	
DC output voltage	18.0 ~ 20.0
Constant output	7.9A
Dynamic Output Characteristics	
Start-up time	3 sec. (@115 Vac and 230Vac full load)
Hold up time	5ms min. (@115 Vac input, full load)
Over Voltage Protection (OVP)	25V
Short circuit protection	Output can be shorted without damage, and auto recovery
Electrostatic discharge (ESD)	15kV (at air discharge) 8kV (at contact discharge)
Dielectric Withstand Voltage	
Primary to secondary	4242 Vdc for 1 second-
Leakage current	60uA at 240Vac/60Hz
Regulatory Requirements	1. FCC class B requirements (USA) 2. VDE class B requirements (German) 3. VCCI classII requirements (Japan)

Power Management

ACPI Mode	Power Management
Mech. Off (G3)	All devices in the system are turned off completely.
Soft Off (G2/S5)	OS initiated shutdown. All devices in the system are turned off completely.
Working (G0/S0)	Individual devices such as the CPU and hard disk may be power managed in this state.
Sleeping State (S3)	CPU Power Down VGA Power Down PCMCIA Suspend Audio Power Down Hard Disk Power Down Super I/O Power Down
Sleeping State (S4)	Also called Hibernate state. System saves all system states and data onto the disk prior to power off the whole system.

Dimensions and Weight

Item	Details
Deminsions	360(W) x 273(D) x 27~32 (H)mm
Weight	6.6lbs (3kg)

Environmental Requirements

Item	Specification
Temperature	
Operating	+5 ~ +35°C
Non-operating	-20 ~ +65°C (storage package)
Humidity	
Operating	20% ~ 80% without condensation
Altitude	Operating sea level 0 to 10,000ft
	Storage sea level 0 to 40,000ft

Model Name	MK4025GAS ,KA100A, 40GB	Pluto MK6025GAS 60GB	Pluto MK8025GAS, 8MB, 80GB
Data Storage Physical			
Per drive, formatted	40.007GB	60.0116GB	80.012GB
Data Heads	2	4	4
Number of Disks	1	2	2
Logical Configuration			
Heads	16	16	16
Cylinders	16,383	16,383	16,383
User Sectors/Track at zone 0	63	63	63
Logical Blocks (LBA)	78,140,160	117,210,240	156,301,488
Data Transfer Rate			
Max transfer rate to host	100MB/sec	100MB/sec	100MB/sec
Seek Time			
Track-to-track	2ms	2ms	2ms
Average	12ms	12ms	12ms
Maximum	22ms	22ms	22ms

TOSHIBA			
Model Name	MK4025GAS ,KA100A, 40GB	Pluto MK6025GAS 60GB	Pluto MK8025GAS, 8MB, 80GB
Data Storage Physical			
Per drive, formatted	40.007GB	60.0116GB	80.012GB
Data Heads	2	4	4

TOSHIBA			
Number of Disks	1	2	2
Logical Configuration			
Heads	16	16	16
Cylinders	16,383	16,383	16,383
User Sectors/Track at zone 0	63	63	63
Logical Blocks (LBA)	78,140,160	117,210,240	156,301,488
Data Transfer Rate			
Max transfer rate to host	100MB/sec	100MB/sec	100MB/sec
Seek Time			
Track-to-track	2ms	2ms	2ms
Average	12ms	12ms	12ms
Maximum	22ms	22ms	22ms

TOSHIBA			
Nominal Power Requirements			
Logic	+5V(±5 %)	+5V(±5 %)	+5V(±5 %)
Start	4.7watts	5.0watts	4.7watts
Seeking	2.6watts	2.9watts	2.6watts
Reading/Writing	2.3watts	2.5watts	2.3watts
Idle	0.9watts	1.05watts	0.9watts
Standby	0.25watts	0.25watts	0.25watts
Sleep	0.1watts	0.1watts	0.1watts
Other			
Rotational Speed	4,200rpm	5,400rpm	4,200rpm
Average Latency	7.14ms	5.56ms	7.14ms
Interface	ATA-2/3/4/5/6	ATA-5	ATA-2/3/4/5/6
Buffer	8MB	16MB	8MB
Physical & Environmental Specs			
Dimensions/Weight:			
Height	0.37" (9.5mm)	0.37" (9.5mm)	0.37"(9.5mm)
Width	2.75" (69.85mm)	2.75" (69.85mm)	2.75" (69.85mm)
Depth	3.94" (100mm)	3.94" (100mm)	3.94"(100mm)
Weight	3.35 oz (94g)	3.56 oz (101g)	3.49 oz (99g)
Ambient Temperature:			
Operating	41° - 131° F (5 to 55° C)	41° - 131° F (5 to 55° C)	41° - 131° F (5 to 55° C)
Non-Operating	-4° - 140° F (-20 to 60° C)	-4° - 140° F (-20 to 60° C)	-4° - 140° F (-20 to 60° C)
Shipping	-40° - 158° F (-40 to 70° C)	-40° - 158° F (-40 to 70° C)	-40° - 158° F (-40 to 70° C)
Vibration and Shock			

Operating Vibration	9.8 M/S ² (1.0G), 5 - 500 Hz	9.8 M/S ² (1.0G), 5 - 500 Hz	9.8 M/S ² (1.0G), 5 - 500 Hz
Operating Shock	200g	200g	200g
Non-Operating Shock	800g	800g	800g
Reliability Characteristics			
Error Rates			
Non-recoverable	1 in 10 ¹³ bits	1 in 10 ¹³ bits	1 in 10 ¹³ bits
Seek	1 in 10 ⁶ seeks	1 in 10 ⁶ seeks	1 in 10 ⁶ seeks
Other			
Preventive Maintenance	None	None	None
MTTF (Power on hours)	300,000	300,000	300,000
Product Life	5 years or 20,000 power ON hours	5 years or 20,000 power ON hours	5 years or 20,000 power ON hours

System Utilities

BIOS Setup Utility

The BIOS Setup Utility is a hardware configuration program built into your computer's BIOS (Basic Input/Output System).

Your computer is already properly configured and optimized, and you do not need to run this utility. However, if you encounter configuration problems, you may need to run Setup. Please also refer to Chapter 4 Troubleshooting when problem arises.

To activate the BIOS Utility, press **F2** during POST (when "Press <F2> to enter Setup" message is prompted on the bottom of screen).

The setup screen displays BIOS as follows: Navigating the BIOS Utility

Function	Item
Information	Display the system informations
Main	Allows the user to specify standard IBM PC AT system parameters
Advanced	Provides advanced settings of the system
Security	Provides security settings of the system
Boot	Allows the user to specify the boot options
Exit	Allows the user to save CMOS setting and exit Setup

During setup, all Fn function keys and power saving functions are disabled.

There are five menu options: Main, Advanced, Security, Boot and Exit.

Follow these instructions:

- To choose a menu, use the cursor left/right keys (**←** **→**).
- To choose a parameter, use the cursor up/down keys (**↑** **↓**).
- To change the value of a parameter, press **F5** or **F6**.
- Press **ESC** while you are in any of the menu options to go to the Exit menu.
- In any menu, you can load default settings by pressing **F9**. You can also press **F10** to save any changes made and exit the BIOS Setup Utility.

NOTE: You can change the value of a parameter if it is enclosed in square brackets. Navigation keys for a particular menu are shown on the bottom of the screen. Help for parameters are found in the Item Specific Help part of the screen. Read this carefully when making changes to parameter values.

Information

Note: This page displays information of the system. Data on the fields (such as CPU type, CPU Speed, Product Name) are subject to different models.

PhoenixBIOS Setup Utility					
Info.	Main	Advanced	Security	Boot	Exit
<p>CPU Type: Intel (R) Pentium (R) M processor 1.73GHz CPU Speed 1733 MHz</p> <p>HDD Model Name: TOSHIBA MK4025GAS HDD Serial Number: Y4C59830S ATAPI Device: HL-DT-ST DVDRAM GMA-4080N System BIOS Ver: S3A11 VGA BIOS Ver: ATi 008.018M.039.000 KBC Ver: 1A20 Serial Number xxxxxxxxxxxxxxxxxxxxxxxxx Asset Tag Number: N/A Product TravelMate 4600 Manufacturer Name: Acer UUID: xxxxxxxxxxxxxxxxxxxxxxxxxxxxxxxxx</p>					
F1 Help	↑↓ Select Item	F5/F6 Change Values	F9 Setup Defaults		
Esc Exit	←→ Select Menu	Enter Select	▶ Sub-Menu	F10 Save and Exit	

Parameter	Description
CPU Type	This field displays CPU type of the system.
CPU Speed	This field displays CPU speed of the system.
HDD Model Name	This item will show the Model name of HDD installed on Primary IDE master. The hard disk model name is automatically detected by the system. If there is no hard disk present or unknown type, "None" should be shown on this field
HDD Serial Number	This item will show the Serial number of HDD installed on Primary IDE master. If no Hard disk or other devices are installed on Primary IDE master, then it will display a blank line
ATAPI Model Name	This item will show the model name of DVD/CD-ROM drive installed on system. The DVD/CD-ROM model name is automatically detected by the system. If there is no DVD/CD-ROM model present or unknown type, "None" should be shown on this field
System BIOS Version	This field reports the BIOS version of system
VGA BIOS Version	This field reports the VGA version of the system
KBC Version	This field displays the versio of the KBC controller.

Parameter	Description
Serial Number	This item will show the Serial number of system.
Asset Tag Number	This item will show the Asset Tag number of the system.
Product Name	This field will show product name.
Manufacturer Name	This field will show manufacturer name.
UUID	This will be visible only when there is an internal LAN device present.

Main

PhoenixBIOS Setup Utility					
Info.	Main	Advanced	Security	Boot	Exit
				Item Specific Help	
System Time:	[02:19:31]			<Tab>, <Shift-Tab>, or <Enter> selects field.	
System Date:	[04/21/2004]				
System Memory:	624 KB	Shows system base memory size			
Extended Memory:	522240 KB	Shows extended memory size			
Video Memory	128 MB	VGA memory size			
Quiet Boot:	[Enabled]				
Power on Display:	[Auto]				
Network Boot:	[Enabled]				
F12 Boot Menu:	[Disabled]				
D2D Recovery :	[Enabled]				
Processor Power Management:		[Enabled]			
F1 Help	↑↓ Select Item	F5/F6 Change Values	F9 Setup Defaults		
Esc Exit	←→ Select Menu	Enter Select	▶ Sub-Menu	F10 Save and Exit	

This menu provides you the information of the system.

Parameter	Description
System Time / System Date	The hours are displayed with 24 hours format. The values set in these two fields take effect immediately.
System Memory	This field reports the memory size of system base memory. The size is fixed to 640KB.
Extended Memory	This field reports the memory size of the extended memory in the system. Extended Memory size = Total memory size - 1 MB
Video Memory	VGA Memory size = 64/128MB
Quiet Boot	Customer Logo display will be shown during POST when it is selected.
Power on display	<p>Auto: During power on process, the system will detect if any display device is connected on external video port. If any external display device is connected, the power on display will be in CRT (or projector) only mode. Otherwise it will be in LCD only mode.</p> <p>Both: Simultaneously enable both the integrated LCD screen and the system's external video port (for an external CRT or projector).</p>

Parameter	Description
Network boot	When this is selected, Boot from LAN feature is enabled. When this is not selected, Boot from LAN feature is then disabled.
F12 Boot Menu	When this is selected, users can modify device boot priority by pressing F12 key during POST. When this is not selected, device boot priority will not be adjustable during POST.
D2D Recovery	Allow user to enable/disable the Disk-to-Disk recovery
Processor Power Management	Selects the Processor Power Management desired: Disabled= C states and GV1/GV3 are disabled GV1/GV3 only= C states are disabled C States Only= GV1/GV3 are disabled Enabled= C States and GV1/GV3 are enabled

Advanced

The Advanced screen contains parameters involving your hardware devices. It also provides advanced settings of the system.

PhoenixBIOS Setup Utility					
Info.	Main	Advanced	Security	Boot	Exit
					Item Specific Help
					All items on this menu cannot be modified in user mode. If any items require changes, please consult your system Supervisor.
F1 Help	↑ ↓ Select Item	F5/F6 Change Values	F9 Setup Defaults		
Esc Exit	← → Select Menu	Enter Select	▶ Sub-Menu	F10 Save and Exit	

NOTE: Serial port, parallel port and FIR function...etc. have been taken off from hardware devices, therefore, this page does not display any information.

Security

The Security screen contains parameters that help safeguard and protect your computer from unauthorized use.

PhoenixBIOS Setup Utility					
Info.	Main	Advanced	Security	Boot	Exit
Supervisor Password Is: Clear User Password Is: Clear HDD Password Is: Clear HDD Master ID: 43883467 Set Supervisor Password [Enter] Set User Password [Enter] Set HDD Password [Enter] Password on boot [Disabled]				Item Specific Help Supervisor Password controls accesses to the setup utility.	
F1 Help	↑ ↓ Select Item	F5/F6 Change Values	F9 Setup Defaults		
Esc Exit	← → Select Menu	Enter Select ▶ Sub-Menu	F10 Save and Exit		

The table below describes the parameters in this screen. Settings in **boldface** are the default and suggested parameter settings.

Parameter	Description	Option
Supervisor Password Is	N/A	N/A
User Password Is	N/A	N/A
HDD Password Is	N/A	N/A
HDD Master ID	N/A	N/A
Set Supervisor Password	Press Enter to set the administrator password. When set, this password protects the BIOS Setup Utility from unauthorized access. [Set]: System password is set [Clear]: System password is not set	Length -- No more than 8 characters Characters -- 0-9, A-Z (not case sensitive)
Set User Password		

Parameter	Description	Option
Set HDD Password	When shown as [Locked], the hard drive password currently can not be changed or disabled. To change or disable it, turn off the system and enter Setup immediately after turning it back on. Press [Enter] to input change, or disable hard drive password.	Enter
Password on boot	Defines whether a password is required or not while the events defined in this group happened. The following sub-options are all requires the Supervisor password for changes and should be grayed out if the user password was used to enter setup. Allows the user to specify whether or not a password is required to boot.	Disabled Enabled

Set Supervisor/User Password

If password on boot is required, the password must be set otherwise it cannot be enabled.

The formats of the password are as follows:

Length No more than 8 characters

Characters 0-9,A-Z (not case sensitive)

While these fields are highlighted and press "Enter", a window similar to the following is shown:

Set SupervisorPassword		
Enter New Password	[]
Confirm New Password	[]

If there is an old password then setup will prompt with the following window instead and a current password will be required to be entered at first:

Set Supervisor Password		
Enter current password	[]
Enter New Password	[]
Confirm New Password	[]

User can now type password in field “Enter New Password”, and re-enter password in field “Confirm New Password” for verification.

If the verification is OK:

The password setting is complete after user presses enter.

Setup Notice

Changes have been saved.

[continue]

If the current password entered does not match the actual current password:

Setup Warning

Invalid password

Re-enter Password

[continue]

If the new password and confirm new password strings do not match:

Setup Warning

Password do not match

Re-enter Password

Boot

This menu allows the user to decide the order of boot devices to load the operating system. Bootable devices includes the distette drive in module bay, the onboard hard disk drive and the CD-ROM in module bay and onboard LAN device.

PhoenixBIOS Setup Utility			
Info.	Main	Advanced	Security
CD-ROM/DVD Drive Floppy Devices +Hard Drive Network Boot			Item Specific Help + and - indicate device categories. Use <Enter> to expand/collapses. Boot order is top-down using only the top device in each category. Use <F6> and <F5> to move highlighted item up and down.
F1 Help	↑↓ Select Item	F5/F6 Change Values	F9 Setup Defaults
Esc Exit	←→ Select Menu	Enter Select ▶ Sub-Menu	F10 Save and Exit

Parameter	Description
+Hard Drive	+ and - indicate device categories. Use <Enter> to expand/collapse.
Floppy Devices	
CD-ROM/DVD Drive	Boot order is top-down using only the top device in each category.
Network Boot	Use <F6> and <F5> to move highlighted item up and down.

Exit

The Exit screen contains parameters that help safeguard and protect your computer from unauthorized use.

PhoenixBIOS Setup Utility					
Info.	Main	Advanced	Security	Boot	Exit
Exit Saving Changes Exit Discarding Changes Load Setup Defaults Discard Changes Save Changes				Item Specific Help Exit System Setup and save your changes to CMOS.	
F1 Help	↑↓ Select Item	F5/F6 Change Values	F9 Setup Defaults		
Esc Exit	←→ Select Menu	Enter Select	▶ Sub-Menu	F10 Save and Exit	

The table below describes the parameters in this screen.

Parameter	Description
Exit Saving Changes	Exit System Setup and save your changes to CMOS
Exit Discarding Changes	Exit utility without saving Setup data to CMOS
Load Setup Default	Load default values for all SETUP items
Discard Changes	Load previous values from CMOS for all SETUP items
Save Changes	Save Setup Data to CMOS

Machine Disassembly and Replacement

This chapter contains step-by-step procedures on how to disassemble the notebook computer for maintenance and troubleshooting.

To disassemble the computer, you need the following tools:

- Wrist grounding strap and conductive mat for preventing electrostatic discharge
- Small Philips screw driver
- Philips screwdriver
- Plastic flat head screw driver
- Tweezers

NOTE: The screws for the different components vary in size. During the disassembly process, group the screws with the corresponding components to avoid mismatch when putting back the components. When you remove the stripe cover, please be careful not to scrape the cover.

General Information

Before You Begin

Before proceeding with the disassembly procedure, make sure that you do the following:

1. Turn off the power to the system and all peripherals.
2. Unplug the AC adapter and all power and signal cables from the system.
3. Remove the battery pack.

NOTE: The screws used to secure bottom case and upper case are more than one type. Please group same type of screw together as you disassemble the system for service purpose. The image below is for your reference. Please pay attention to the explanation below.

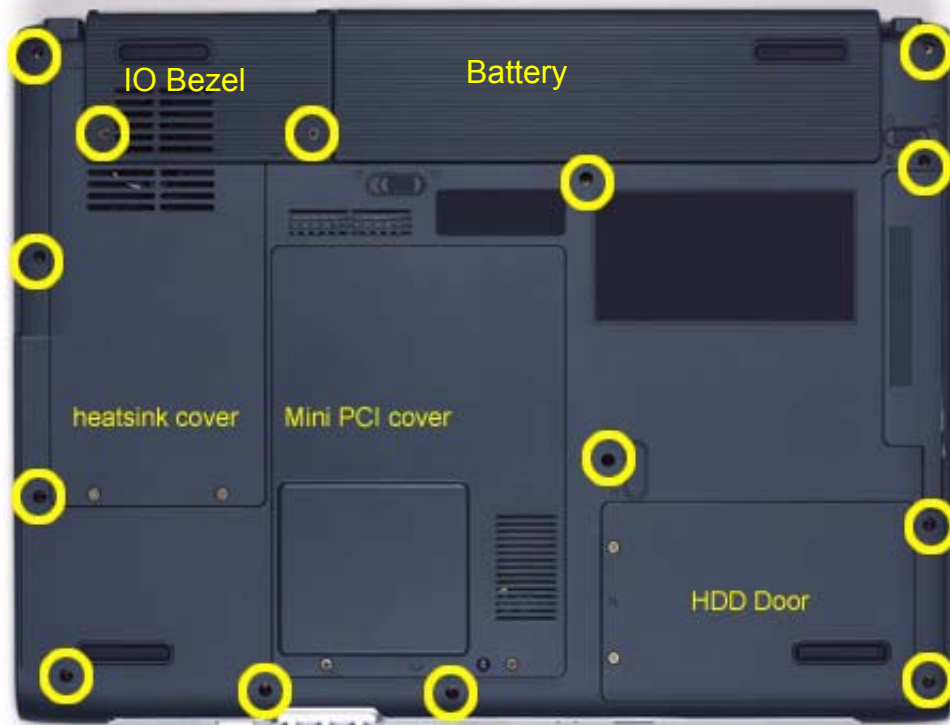

The screws that secure heatsink cover, Mini PCI cover and HDD cover are with the covers. There is no need to worry about mix them up. However, please notice that you have to group the screws on the following locations together. There are twenty screws holding the bottom case to upper case but some screws are inside the system. You may have to remove the HDD, the heatsink cover to see these screws. Mini PCI cover here also called RAM/Wireless cover.

Screw Type	Location	Quantity
M2.5*6	Bottom case and IO bezel (highlight with yellow circle)	14
M2.5*6	Remove the IO bezel then you will see.	2
M2.5*6	Remove the heatsink cover then you will see.	1
M2.5*6	Remove the HDD cover then you will see.	1
M2.5*3	Detach the HDD module then you will see.	1
M2.5*3	Remove the battery then you will see.	1

Disassembly Procedure Flowchart

The flowchart on the succeeding page gives you a graphic representation on the entire disassembly sequence and instructs you on the components that need to be removed during servicing. For example, if you want to remove the system board, you must first remove the keyboard, then disassemble the inside assembly frame in that order.

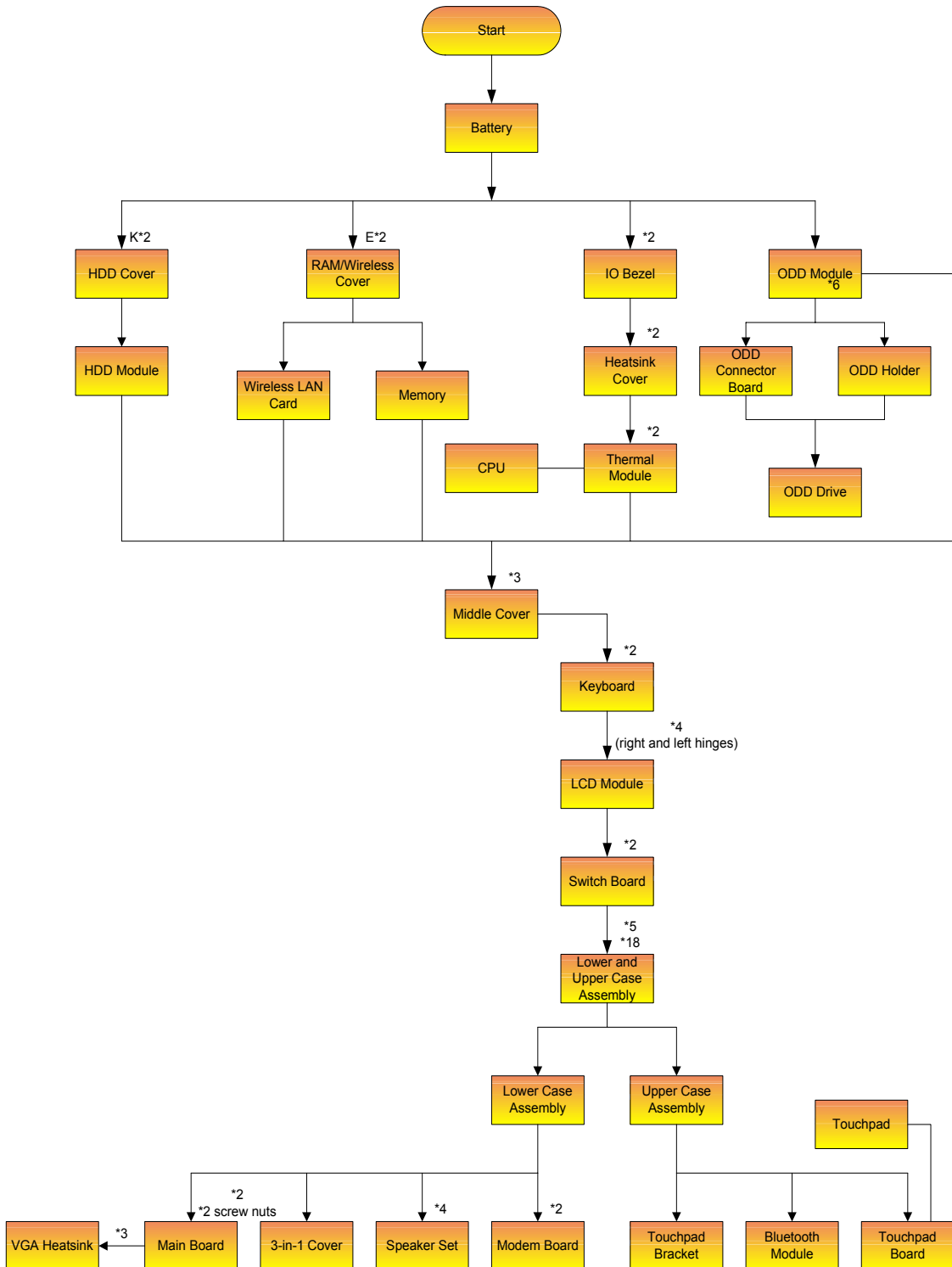

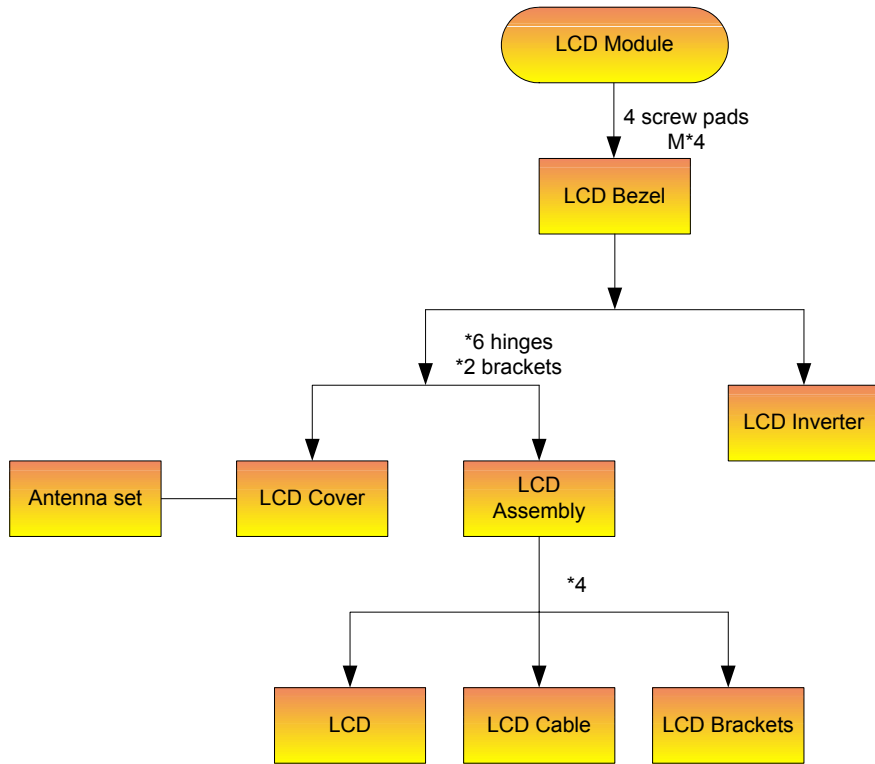

Screw List

Item	Description	
	SCREW M2.0X3.0-I-NI-NYLOK	86.A03V7.012
	SCREW I2.5*3M-BNIH(M2.5L3)	86.T25V7.012
	SCREW M2.5*4L-BZN-NYLOK	86.A03V7.006
	SCREW M2.0X5-I-NI-NYLOK	86.T23V7.006
	SCREW MM25060IL69	86.A08V7.004
	SCREW M2.0*5-I(NI)(NYLOK)	86.T23V7.010
	SCREW M2.0X2.5-I-NI-NYLOK	86.A03V7.007
	SCREW I2*3M-NIHY (M2L3)	86.T25V7.008
	SCREW M1.7*3.0-I (BK)	86.T50V7.001
	SCREW I3*3.5M-NIH(M3L3.5)	86.A03V7.011

Removing the Battery Pack

NOTE: This chapter is base on Aspire 1410 and Aspire 1680 to edit. Since they have the similar disassemble and reassemble procedures.

1. Unlock the battery lock.
2. Slide the battery latch as shown then remove the battery pack.



Removing the HDD Module/the memory and the Wireless LAN Card/ the Thermal Module and the CPU/ODD and the LCD Module

Removing the HDD Module

1. Remove the two screws holding the HDD cover.
2. Remove the HDD cover.
3. Detach the HDD module then remove it.



Removing the Memory and the Wireless LAN Card

1. Remove the two screws that secure the RAM/Wireless cover.
2. Remove the RAM/Wireless cover.

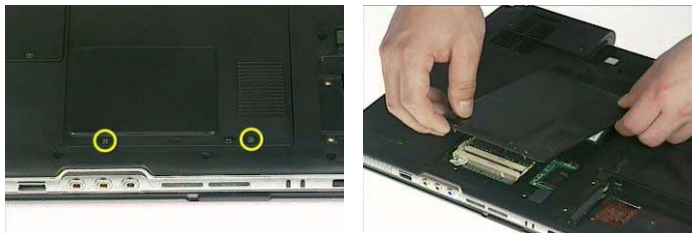

3. Pop up the memory then remove it.
4. Disconnect the auxiliary and the main wireless antennae.
5. Pop the wireless LAN card then remove it.



Removing the Thermal Module and CPU

1. Remove the two screws holding the IO bezel.
2. Then remove the IO bezel.
3. Remove the two screws that secure the heatsink cover.

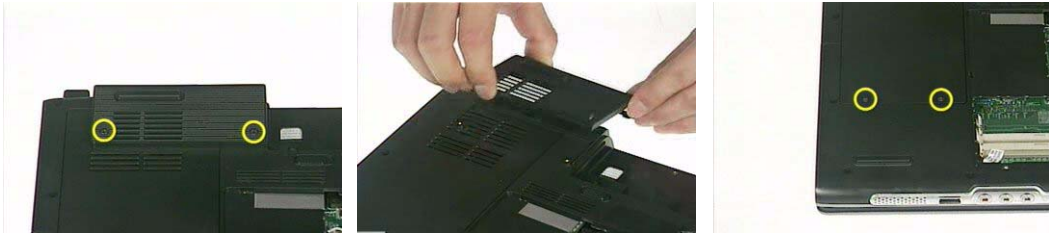

4. Remove the heatsink cover from the main unit.
5. Disconnect the fan cable.

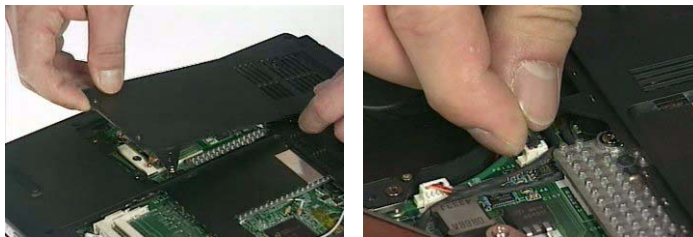

6. Remove the four screws that secure the thermal module.
7. Pull the thermal module outwards then remove it.

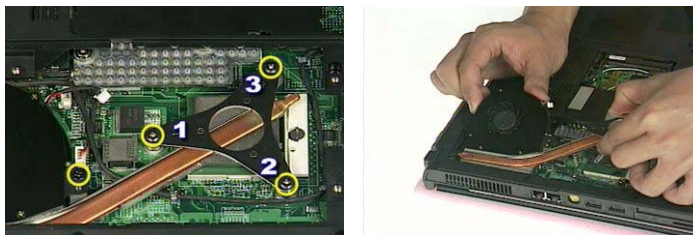

NOTE: The edge of the thermal module as shown is very sharp. Be very careful as you remove the thermal module.

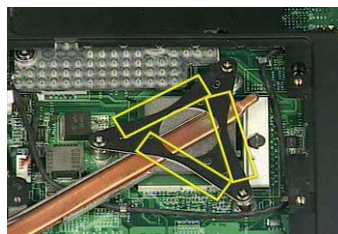

8. Use a flat-bladed screwdriver to release the CPU lock.
9. Remove the CPU from the socket carefully.

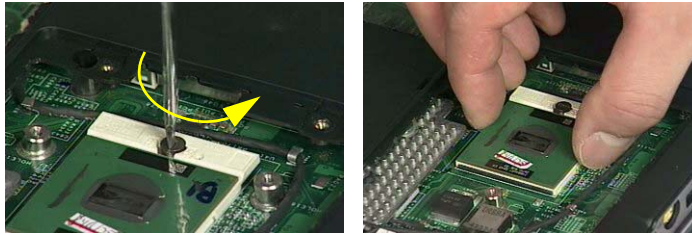

Removing the ODD Module

1. Remove the three screws holding the middle cover.
2. Detach the middle cover carefully.

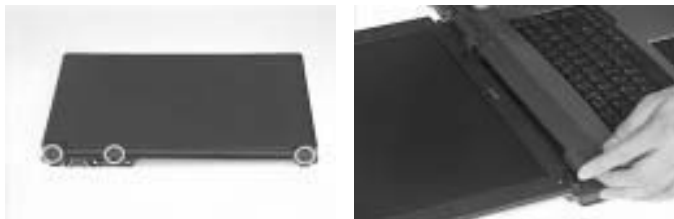

3. Turn over the keyboard as shown.
4. Disconnect the keyboard cable from the main board then remove the keyboard.



5. Remove the screw that fastens the ODD module.
6. Turn over the notebook computer then detach the ODD module carefully.

NOTE: When you reattach the ODD, please make sure you attach the ODD module completely to the main unit. Otherwise, you can not fasten the screw and the screw may damage the main board.



Removing the LCD Module

1. Remove the three screws holding the keyboard cover.
2. Open the LCD module as the picture shown then detach the keyboard cover from the main unit.



3. Remove the two screws that secure the keyboard as shown.
4. Turn over the keyboard as shown and disconnect the keyboard cable then remove the keyboard.
5. Pull out the antenna set with a tweezers then take out the antenna set from the main unit.

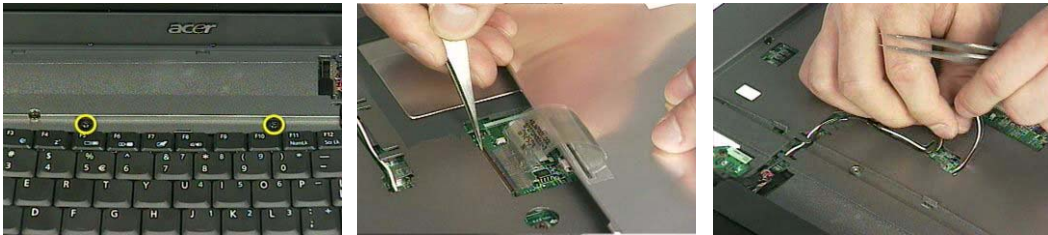

6. Disconnect the LCD coaxial cable.
7. Remove the four screws holding the right and the left hinge. Two on each side.
8. Then detach the LCD module from the main unit.



Disassembling the Main Unit

Separate the Main Unit Into the Upper and the Lower Case Assembly

1. Remove the two screws holding the switch board.
2. Remove the switch board.
3. Disconnect the touchpad FFC from the main board.



4. Disconnect the bluetooth cable.
5. Remove the five screws that secure the upper case.
6. Remove the eighteen screws on the bottom as shown.

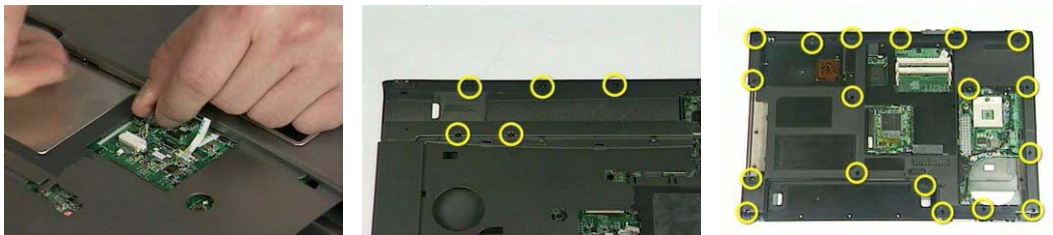

7. Detach the upper case assembly and place it next to the lower case assembly.
8. Disconnect the microphone cable then remove the upper case assembly.

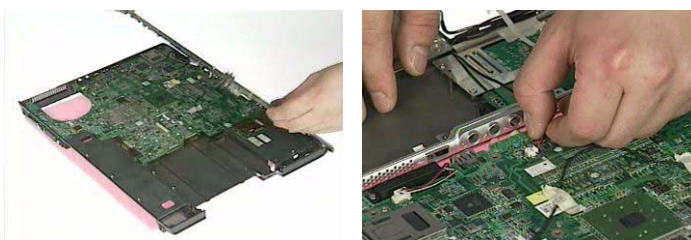

Disassembling the Upper Case Assembly

1. Disconnect the touchpad board to touchpad FFC.
2. Disconnect the touchpad board to main board FFC.
3. Then detach the touchpad board to main board FFC from the touchpad board.

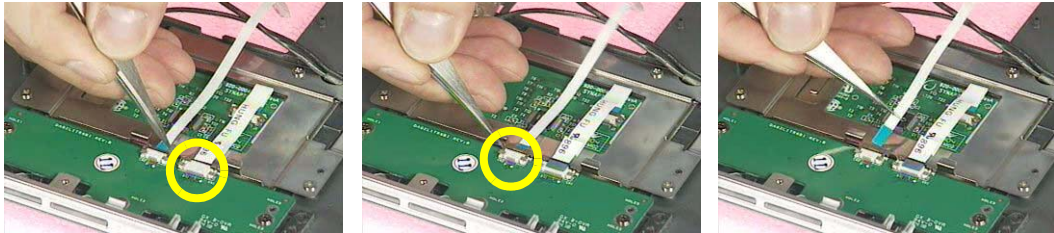

4. Remove the three screws that secure the touchpad board.
5. Remove the touchpad board from the upper case.
6. Disconnect the touchpad board to touchpad FFC.



7. Remove the touchpad board to touchpad FFC from the upper case assembly.
8. Remove the four screws holding the touchpad bracket.
9. Detach the touchpad bracket from the upper case assembly.

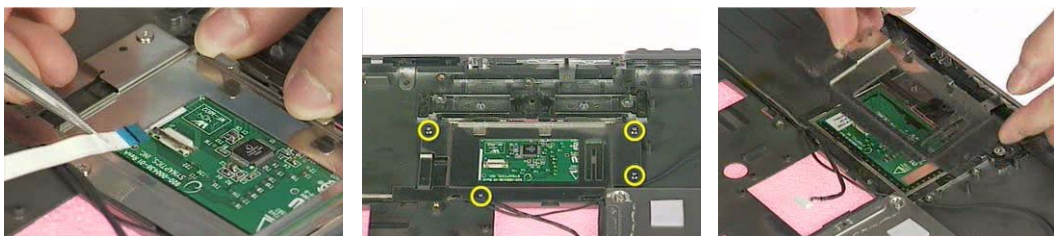

10. Remove the touchpad from the upper case.
11. Remove the two screws that secure the bluetooth module.
12. Disconnect the bluetooth module then remove it.



Disassembling the Lower Case Assembly

1. Disconnect the MDC cable from the modem board.
2. Detach the MDC cable from the main board.
3. Remove the two screws holding the modem board.

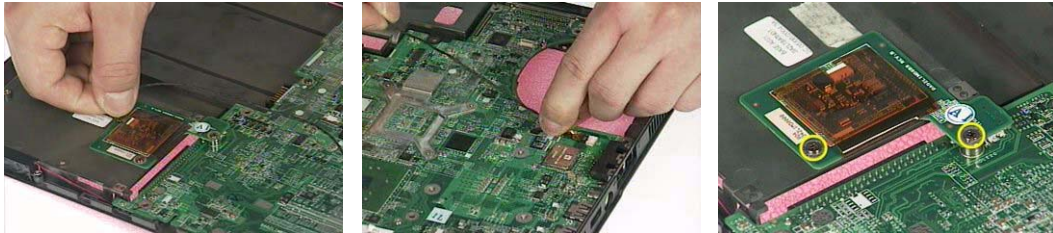

4. Remove the modem board from the lower case.
5. Disconnect the speaker cable from the main board.
6. Remove the two screws that secure the main board.

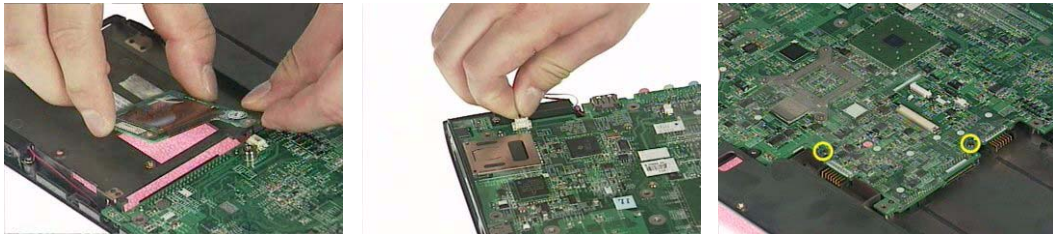

7. Remove the two screw nuts as shown.
8. The you can detach the main board from the upper case.
9. Remove the three screws that secure the VGA heatsink.



10. Remove the VGA heatsink from the main board as shown.
11. Remove the three in one cover from the lower case.
12. Remove the two screws that secure the speaker set on one side.



-
13. Then remove another two screws holding the speaker set on the other side.
 14. Then take out the speaker set from the lower case.



Disassembling the LCD Module

1. Remove the four screw caps as shown.
2. Remove the four screws holding the LCD bezel.
3. Then detach the LCD bezel from the LCD module.



4. Disconnect the inverter board then remove it.
5. Remove the three screws holding the right hinge.
6. Then remove the three screws that secure the left hinge.

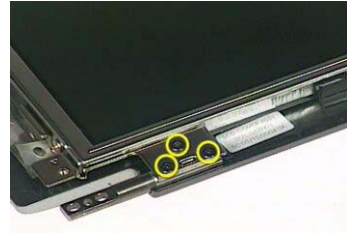
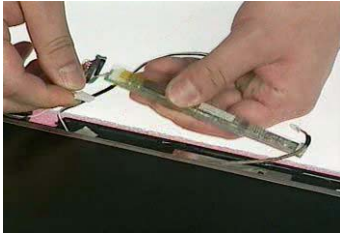

7. Remove one screw that secure the LCD bracket.
8. Remove another screw holding the LCD bracket on the other side.
9. Then detach the LCD panel from the LCD cover carefully.



10. Remove the two screws holding the right bracket.
11. Then remove the right bracket.
12. Remove another two screws that tighten the left bracket.



13. Remove the left bracket as the picture shows.
14. Tear off the tape fastening the LCD cable.
15. Tear off the the LCD cable fastening the LCD cable, then remove it..

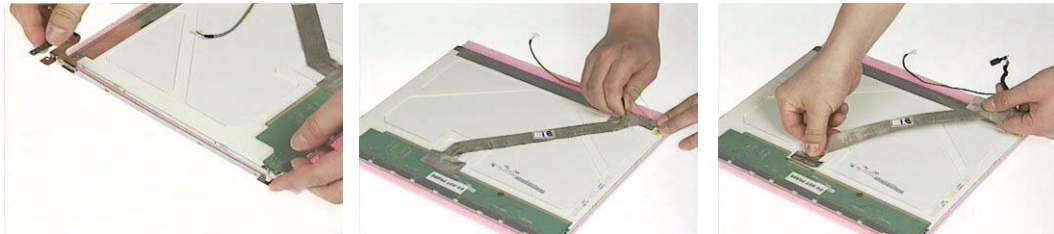

Disassembling the External Modules

Disassembling the HDD Module

1. Remove the two screws holding the HDD bracket on one side.
2. Remove another two screws holding the HDD bracket on the other side.
3. Then take the hard disc drive out from the HDD bracket.

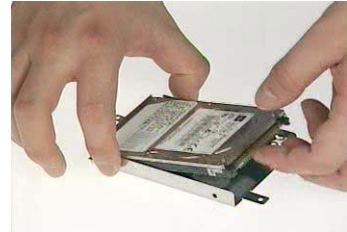
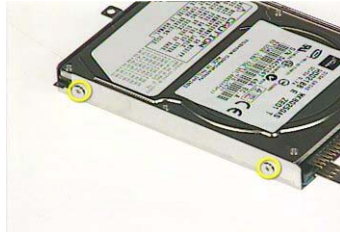

Disassembling the Optical Drive Module

1. Remove the four screws as the picture shows.
2. Remove the two screws that secure the optical disc drive and the ODD holder.



3. Push the ODD holder as shown.
4. Detach the ODD holder.
5. Disconnect the ODD connector board then remove it.

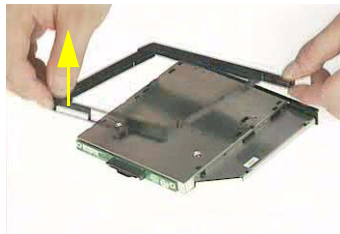

Troubleshooting

Use the following procedure as a guide for computer problems.

NOTE: The diagnostic tests are intended to test only Acer products. Non-Acer products, prototype cards, or modified options can give false errors and invalid system responses.

1. Obtain the failing symptoms in as much detail as possible.
2. Verify the symptoms by attempting to re-create the failure by running the diagnostic test or by repeating the same operation.

System Check Procedures

External Diskette Drive Check

Do the following to isolate the problem to a controller, driver, or diskette. A write-enabled, diagnostic diskette is required.

NOTE: Make sure that the diskette does not have more than one label attached to it. Multiple labels can cause damage to the drive or cause the drive to fail.

Do the following to select the test device.

1. Boot from the diagnostics diskette and start the diagnostics program.
2. See if FDD Test is passed as the program runs to FDD Test.
3. Follow the instructions in the message window.

If an error occurs with the internal diskette drive, reconnect the diskette connector on the system board.

If the error still remains:

1. Reconnect the external diskette drive/DVD-ROM module.
2. Replace the external diskette drive/CD-ROM module.
3. Replace the main board.

External CD-ROM Drive Check

Do the following to isolate the problem to a controller, drive, or CD-ROM. Make sure that the CD-ROM does not have any label attached to it. The label can cause damage to the drive or can cause the drive to fail.

Do the following to select the test device:

1. Boot from the diagnostics diskette and start the diagnostics program.
2. See if CD-ROM Test is passed when the program runs to CD-ROM Test.
3. Follow the instructions in the message window.

If an error occurs, reconnect the connector on the System board. If the error still remains:

1. Reconnect the external diskette drive/CD-ROM module.
2. Replace the external diskette drive/CD-ROM module.
3. Replace the main board.

Keyboard or Auxiliary Input Device Check

Remove the external keyboard if the internal keyboard is to be tested.

If the internal keyboard does not work or an unexpected character appears, make sure that the flexible cable extending from the keyboard is correctly seated in the connector on the system board.

If the keyboard cable connection is correct, run the Keyboard Test.

If the tests detect a keyboard problem, do the following one at a time to correct the problem. Do not replace a non-defective FRU:

1. Reconnect the keyboard cables.
2. Replace the keyboard.
3. Replace the main board.

The following auxiliary input devices are supported by this computer:

- Numeric keypad
- External keyboard

If any of these devices do not work, reconnect the cable connector and repeat the failing operation.

Memory check

Memory errors might stop system operations, show error messages on the screen, or hang the system.

1. Boot from the diagnostics diskette and start the doagmpstotics program (please refer to main board).
2. Go to the diagnostic memory in the test items.
3. Press F2 in the test items.
4. Follow the instructions in the message window.

NOTE: Make sure that the DIMM is fully installed into the connector. A loose connection can cause an error.

Power System Check

To verify the symptom of the problem, power on the computer using each of the following power sources:

1. Remove the battery pack.
2. Connect the power adapter and check that power is supplied.
3. Disconnect the power adapter and install the charged battery pack; then check that power is supplied by the battery pack.

If you suspect a power problem, see the appropriate power supply check in the following list:

- “Check the Power Adapter” on page 63
- “Check the Battery Pack” on page 63

Check the Power Adapter

Unplug the power adapter cable from the computer and measure the output voltage at the plug of the power adapter cable. See the following figure

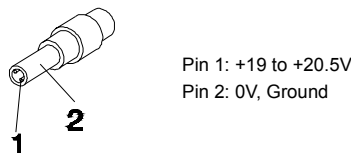

1. If the voltage is not correct, replace the power adapter.
2. If the voltage is within the range, do the following:
 - Replace the System board.
 - If the problem is not corrected, see “Undetermined Problems” on page 77.
 - If the voltage is not correct, go to the next step.

NOTE: An audible noise from the power adapter does not always indicate a defect.

3. If the power-on indicator does not light up, check the power cord of the power adapter for correct continuity and installation.
4. If the operational charge does not work, see “Check the Battery Pack” on page 63.

Check the Battery Pack

To check the battery pack, do the following:

From Software:

1. Check out the Power Management in control Panel

2. In Power Meter, confirm that if the parameters shown in the screen for Current Power Source and Total Battery Power Remaining are correct.
3. Repeat the steps 1 and 2, for both battery and adapter.
4. This helps you identify first the problem is on recharging or discharging.

From Hardware:

1. Power off the computer.
2. Remove the battery pack and measure the voltage between battery terminals 1(+) and 6(ground). See the following figure

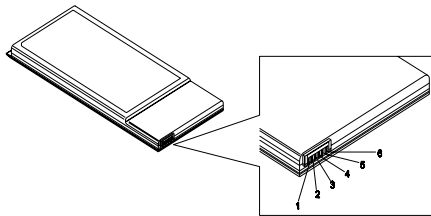

3. If the voltage is still less than 7.5 Vdc after recharging, replace the battery.

To check the battery charge operation, use a discharged battery pack or a battery pack that has less than 50% of the total power remaining when installed in the computer.

If the battery status indicator does not light up, remove the battery pack and let it return to room temperature. Re-install the battery pack.

If the charge indicator still does not light up, replace the battery pack. If the charge indicator still does not light up, replace the DC/DC charger board.

Touchpad Check

If the touchpad doesn't work, do the following actions one at a time to correct the problem. Do not replace a non-defective FRU:

1. Reconnect the touchpad cables.
2. Replace the touchpad.
3. Replace the system board.

After you use the touchpad, the pointer drifts on the screen for a short time. This self-acting pointer movement can occur when a slight, steady pressure is applied to the touchpad pointer. This symptom is not a hardware problem. No service actions are necessary if the pointer movement stops in a short period of time.

Power-on Self-Test Error Messages

The POST error message index lists the error message and their possible causes. The most likely cause is listed first.

NOTE: Perform the FRU replacement or actions in the sequence shown in FRU/Action column, if the FRU replacement does not solve the problem, put the original part back in the computer. Do not replace a non-defective FRU.

This index can also help you determine the next possible FRU to be replaced when servicing a computer.

If the symptom is not listed, see “Undetermined Problems” on page 77.

The following lists the error messages that the BIOS displays on the screen and the error symptoms classified by function.

NOTE: Most of the error messages occur during POST. Some of them display information about a hardware device, e.g., the amount of memory installed. Others may indicate a problem with a device, such as the way it has been configured.

NOTE: If the system fails after you make changes in the BIOS Setup Utility menus, reset the computer, enter Setup and install Setup defaults or correct the error.

Index of Error Messages

Error Code List

Error Codes	Error Messages
006	Equipment Configuration Error Causes: 1. CPU BIOS Update Code Mismatch 2. IDE Primary Channel Master Drive Error (The causes will be shown before "Equipment Configuration Error")
010	Memory Error at xxxx:xxx:xxxh (R:xxxh, W:xxxh)
070	Real Time Clock Error
071	CMOS Battery Bad
072	CMOS Checksum Error
110	System disabled. Incorrect password is specified.
<No error code>	Battery critical LOW In this situation BIOS will issue 4 short beeps then shut down system, no message will show.
<No error code>	Thermal critical High In this situation BIOS will shut down system, not show message.

Error Message List

Error Messages	FRU/Action in Sequence
Failure Fixed Disk	Reconnect hard disk drive connector. "Load Default Settings" in BIOS Setup Utility. Hard disk drive System board
Stuck Key	see "Keyboard or Auxiliary Input Device Check" on page 62.
Keyboard error	see "Keyboard or Auxiliary Input Device Check" on page 62.
Keyboard Controller Failed	see "Keyboard or Auxiliary Input Device Check" on page 62.
Keyboard locked - Unlock key switch	Unlock external keyboard
Monitor type does not match CMOS - Run Setup	Run "Load Default Settings" in BIOS Setup Utility.
Shadow RAM Failed at offset: nnnn	BIOS ROM System board
System RAM Failed at offset: nnnn	DIMM System board
Extended RAM Failed at offset: nnnn	DIMM System board
System battery is dead - Replace and run Setup	Replace RTC battery and Run BIOS Setup Utility to reconfigure system time, then reboot system.
System CMOS checksum bad - Default configuration used	RTC battery Run BIOS Setup Utility to reconfigure system time, then reboot system.
System timer error	RTC battery Run BIOS Setup Utility to reconfigure system time, then reboot system. System board

Error Message List

Error Messages	FRU/Action in Sequence
Real time clock error	RTC battery Run BIOS Setup Utility to reconfigure system time, then reboot system. System board
Previous boot incomplete - Default configuration used	Run "Load Default Settings" in BIOS Setup Utility. RTC battery System board
Memory size found by POST differed from CMOS	Run "Load Default Settings" in BIOS Setup Utility. DIMM System board
Diskette drive A error	Check the drive is defined with the proper diskette type in BIOS Setup Utility See "External Diskette Drive Check" on page 62.
Incorrect Drive A type - run SETUP	Check the drive is defined with the proper diskette type in BIOS Setup Utility
System cache error - Cache disabled	System board
CPU ID:	System board
DMA Test Failed	DIMM System board
Software NMI Failed	DIMM System board
Fail-Safe Timer NMI Failed	DIMM System board
Device Address Conflict	Run "Load Default Settings" in BIOS Setup Utility. RTC battery System board
Allocation Error for device	Run "Load Default Settings" in BIOS Setup Utility. RTC battery System board
Failing Bits: nnnn	DIMM BIOS ROM System board
Fixed Disk n	None
Invalid System Configuration Data	BIOS ROM System board
I/O device IRQ conflict	Run "Load Default Settings" in BIOS Setup Utility. RTC battery System board
Operating system not found	Enter Setup and see if fixed disk and drive A: are properly identified. Diskette drive Hard disk drive System board

Error Message List

No beep Error Messages	FRU/Action in Sequence
No beep, power-on indicator turns off and LCD is blank.	Power source (battery pack and power adapter). See "Power System Check" on page 63. Ensure every connector is connected tightly and correctly. Reconnect the DIMM. LED board. System board.
No beep, power-on indicator turns on and LCD is blank.	Power source (battery pack and power adapter). See "Power System Check" on page 63. Reconnect the LCD connector Hard disk drive LCD inverter ID LCD cable LCD Inverter LCD System board
No beep, power-on indicator turns on and LCD is blank. But you can see POST on an external CRT.	Reconnect the LCD connectors LCD inverter ID LCD cable LCD inverter LCD System board
No beep, power-on indicator turns on and a blinking cursor shown on LCD during POST.	Ensure every connector is connected tightly and correctly System board
No beep during POST but system runs correctly.	Speaker System board

Phoenix BIOS Beep Codes

Code	Beeps	POST Routine Description
02h		Verify Real Mode
03h		Disable Non-Maskable Interrupt (NMI)
04h		Get CPU type
06h		Initialize system hardware
08h		Initialize chipset with initial POST values
09h		Set IN POST flag
0Ah		Initialize CPU registers
0Bh		Enable CPU cache
0Ch		Initialize caches to initial POST values
0Eh		Initialize I/O component
0Fh		Initialize the local bus IDE
10h		Initialize Power Management
11h		Load alternate registers with initial POST values
12h		Restore CPU control word during warm boot
13h		Initialize PCI Bus Mastering devices
14h		Initialize keyboard controller
16h	1-2-2-3	BIOS ROM checksum
17h		Initialize cache before memory autosize
18h		8254 timer initialization
1Ah		8237 DMA controller initialization
1Ch		Reset Programmable Interrupt Controller
20h	1-3-1-1	Test DRAM refresh
22h	1-3-1-3	Test 8742 Keyboard Controller
24h		Set ES segment register to 4 GB
26h		Enable A20 line
28h		Autosize DRAM
29h		Initialize POST Memory Manager
2Ah		Clear 215 KB base RAM
2Ch	1-3-4-1	RAM failure on address line xxxx
2Eh	1-3-4-3	RAM failure on data bits xxxx of low byte of memory bus
2Fh		Enable cache before system BIOS shadow
30h	1-4-1-1	RAM failure on data bits xxxx of high byte of memory bus
32h		Test CPU bus-clock frequency
33h		Initialize Phoenix Dispatch Manager
36h		Warm start shut down
38h		Shadow system BIOS ROM
3Ah		Autosize cache
3Ch		Advanced configuration of chipset registers
3Dh		Load alternate registers with CMOS values
42h		Initialize interrupt vectors
45h		POST device initialization

Code	Beeps	POST Routine Description
46h	2-1-2-3	Check ROM copyright notice
48h		Check video configuration against CMOS
49h		Initialize PCI bus and devices
4Ah		Initialize all video adapters in system
4Bh		QuietBoot start (optional)
4Ch		Shadow video BIOS ROM
4Eh		Display BIOS copyright notice
50h		Display CPU type and speed
51h		Initialize EISA board
52h		Test keyboard
54h		Set key click if enabled
58h	2-2-3-1	Test for unexpected interrupts
59h		Initialize POST display service
5Ah		Display prompt "Press F2 to enter SETUP"
5Bh		Disable CPU cache
5Ch		Test RAM between 512 and 640 KB
60h		Test extended memory
62h		Test extended memory address lines
64h		Jump to User Patch1
66h		Configure advanced cache registers
67h		Initialize Multi Processor APIC
68h		Enable external and CPU caches
69h		Setup System Management Mode (SMM) area
6Ah		Display external L2 cache size
6Bh		Load custom defaults (optional)
6Ch		Display shadow-area message
6Eh		Display possible high address for UMB recovery
70h		Display error messages
72h		Check for configuration errors
76h		Check for keyboard errors
7Ch		Set up hardware interrupt vectors
7Eh		Initialize coprocessor if present
80h		Disable onboard Super I/O ports and IRQs
81h		Late POST device initialization
82h		Detect and install external RS232 ports
83h		Configure non-MCD IDE controllers
84h		Detect and install external parallel ports
85h		Initialize PC-compatible PnP ISA devices
86h		Re-initialize onboard I/O ports
87h		Configure Motherboard Configurable Devices (optional)
88h		Initialize BIOS Area
89h		Enable Non-Maskable Interrupts (NMI)
8Ah		Initialize Extended BIOS Data Area
8Bh		Test and initialize PS/2 mouse

Code	Beeps	POST Routine Description
8Ch		Initialize floppy controller
8Fh		Determine number of ATA drives (optional)
90h		Initialize hard-disk controllers
91h		Initialize local-bus hard-disk controllers
92h		Jump to UserPatch2
93h		Build MPTABLE for multi-processor boards
95h		Install CD ROM for boot
96h		Clear huge ES segment register
97h		Fixup Multi Processor table
98h	1-2	Search for option ROMs. One long, two short beeps on checksum failure.
99h		Check for SMART drive (optional)
9Ah		Shadow option ROMs
9Ch		Set up Power Management
9Dh		Initialize security engine (optional)
9Eh		Enable hardware interrupts
9Fh		Determine number of ATA and SCSI drives
A0h		Set time of day
A2h		Check key lock
A4h		Initialize Typematic rate
A8h		Erase F2 prompt
AAh		Scan for F2 key stroke
ACh		Enter SETUP
AEh		Clear Boot flag
B0h		Check for errors
B2h		POST done- prepare to boot operating system
B4h	1	One short beep before boot
B5h		Terminate QuietBoot (optional)
B6h		Check password (optional)
B9h		Prepare Boot
BAh		Initialize DMI parameters
BBh		Initialize PnP Option ROMs
BCh		Clear parity checkers
BDh		Display MultiBoot menu
BEh		Clear screen (optional)
BFh		Check virus and backup reminders
C0h		Try to boot with INT 19
C1h		Initialize POST Error Manager (PEM)
C2h		Initialize error logging
C3h		Initialize error display function
C4h		Initialize system error handler
C5h		PnPnd dual CMOS (optional)
C6h		Initialize notebook docking (optional)
C7h		Initialize notebook docking late
C8h		Force check (optional)
C9h		Extended checksum (optional)

Code	Beeps	POST Routine Description
D2h		Unknown interrupt
E0h		Initialize the chipset
E1h		Initialize the bridge
E2h		Initialize the CPU
E3h		Initialize the system timer
E4h		Initialize system I/O
E5h		Check force recovery boot
E6h		Checksum BIOS ROM
E7h		Go to BIOS
E8h		Set Huge Segment
E9h		Initialize Multi Processor
EAh		Initialize OEM special code
EBh		Initialize PIC and DMA
ECh		Initialize Memory type
EDh		Initialize Memory size
EEh		Shadow Boot Block
EFh		System memory test
F0h		Initialize interrupt vectors
F1h		Initialize Run Time Clock
F2h		Initialize video
F3h		Initialize System Management Mode
F4h	1	Output one beep before boot
F5h		Boot to Mini DOS
F6h		Clear Huge Segment
F7h		Boot to Full DOS

Index of Symptom-to-FRU Error Message

LCD-Related Symptoms

Symptom / Error	Action in Sequence
LCD backlight doesn't work LCD is too dark LCD brightness cannot be adjusted LCD contrast cannot be adjusted	Enter BIOS Utility to execute "Load Setup Default Settings", then reboot system. Reconnect the LCD connectors. Keyboard (if contrast and brightness function key doesn't work). LCD inverter ID LCD cable LCD inverter LCD System board
Unreadable LCD screen Missing pels in characters Abnormal screen Wrong color displayed	Reconnect the LCD connector LCD inverter ID LCD cable LCD inverter LCD System board
LCD has extra horizontal or vertical lines displayed.	LCD inverter ID LCD inverter LCD cable LCD System board

Indicator-Related Symptoms

Symptom / Error	Action in Sequence
Indicator incorrectly remains off or on, but system runs correctly	Reconnect the inverter board Inverter board System board

Power-Related Symptoms

Symptom / Error	Action in Sequence
Power shuts down during operation	Power source (battery pack and power adapter). See "Power System Check" on page 63. Battery pack Power adapter Hard drive & battery connection board System board
The system doesn't power-on.	Power source (battery pack and power adapter). See "Power System Check" on page 63. Battery pack Power adapter Hard drive & battery connection board System board
The system doesn't power-off.	Power source (battery pack and power adapter). See "Power System Check" on page 63. Hold and press the power switch for more than 4 seconds. System board

Power-Related Symptoms

Symptom / Error	Action in Sequence
Battery can't be charged	See "Check the Battery Pack" on page 63. Battery pack System board

PCMCIA-Related Symptoms

Symptom / Error	Action in Sequence
System cannot detect the PC Card (PCMCIA)	PCMCIA slot assembly System board
PCMCIA slot pin is damaged.	PCMCIA slot assembly

Memory-Related Symptoms

Symptom / Error	Action in Sequence
Memory count (size) appears different from actual size.	Enter BIOS Setup Utility to execute "Load Default Settings, then reboot system. DIMM System board

Speaker-Related Symptoms

Symptom / Error	Action in Sequence
In Windows, multimedia programs, no sound comes from the computer.	Audio driver Speaker System board
Internal speakers make noise or emit no sound.	Speaker System board

Power Management-Related Symptoms

Symptom / Error	Action in Sequence
The system will not enter hibernation	Keyboard (if control is from the keyboard) Hard disk drive System board
The system doesn't enter hibernation mode and four short beeps every minute.	See "Sleeping State (S4)" on page 27. Press Fn+  and see if the computer enters hibernation mode. Touchpad Keyboard Hard disk connection board Hard disk drive System board
The system doesn't enter standby mode after closing the LCD	See "Sleeping State (S4)" on page 27. LCD cover switch System board
The system doesn't resume from hibernation mode.	See "Sleeping State (S4)" on page 27. Hard disk connection board Hard disk drive System board
The system doesn't resume from standby mode after opening the LCD.	See "Sleeping State (S4)" on page 27. LCD cover switch System board

Power Management-Related Symptoms

Symptom / Error	Action in Sequence
Battery fuel gauge in Windows doesn't go higher than 90%.	Remove battery pack and let it cool for 2 hours Refresh battery (continue use battery until power off, then charge battery) Battery pack System board
System hangs intermittently.	Reconnect hard disk/CD-ROM drives. Hard disk connection board System board

Peripheral-Related Symptoms

Symptom / Error	Action in Sequence
System configuration does not match the installed devices.	Enter BIOS Setup Utility to execute "Load Default Settings", then reboot system. Reconnect hard disk/CD-ROM/diskette drives.
External display does not work correctly.	Press Fn+F5, LCD/CRT/Both display switching System board
USB does not work correctly	System board
Print problems.	Ensure the "Parallel Port" in the "Onboard Devices Configuration" of BIOS Setup Utility is set to Enabled. Onboard Devices Configuration Run printer self-test. Printer driver Printer cable Printer System Board
Serial or parallel port device problems.	Ensure the "Serial Port" in the Devices Configuration" of BIOS Setup Utility is set to Enabled. Device driver Device cable Device System board

Keyboard/Touchpad-Related Symptoms

Symptom / Error	Action in Sequence
Keyboard (one or more keys) does not work.	Reconnect the keyboard cable. Keyboard System board
Touchpad does not work.	Reconnect touchpad cable. Touchpad board System board

Modem-Related Symptoms

Symptom / Error	Action in Sequence
Internal modem does not work correctly.	Modem phone port modem combo board System board

NOTE: If you cannot find a symptom or an error in this list and the problem remains, see "Undetermined Problems" on page 77.

Intermittent Problems

Intermittent system hang problems can be caused by a variety of reasons that have nothing to do with a hardware defect, such as: cosmic radiation, electrostatic discharge, or software errors. FRU replacement should be considered only when a recurring problem exists.

When analyzing an intermittent problem, do the following:

1. Run the advanced diagnostic test for the system board in loop mode at least 10 times.
2. If no error is detected, do not replace any FRU.
3. If any error is detected, replace the FRU. Rerun the test to verify that there are no more errors.

Undetermined Problems

The diagnostic problems does not identify which adapter or device failed, which installed devices are incorrect, whether a short circuit is suspected, or whether the system is inoperative.

Follow these procedures to isolate the failing FRU (do not isolate non-defective FRU).

NOTE: Verify that all attached devices are supported by the computer.

NOTE: Verify that the power supply being used at the time of the failure is operating correctly. (See "Power System Check" on page 63):

1. Power-off the computer.
2. Visually check them for damage. If any problems are found, replace the FRU.
3. Remove or disconnect all of the following devices:
 - Non-Acer devices
 - Printer, mouse, and other external devices
 - Battery pack
 - Hard disk drive
 - DIMM
 - CD-ROM/Diskette drive Module
 - PC Cards
4. Power-on the computer.
5. Determine if the problem has changed.
6. If the problem does not recur, reconnect the removed devices one at a time until you find the failing FRU.
7. If the problem remains, replace the following FRU one at a time. Do not replace a non-defective FRU:
 - System board
 - LCD assembly

Jumper and Connector Locations

Top View

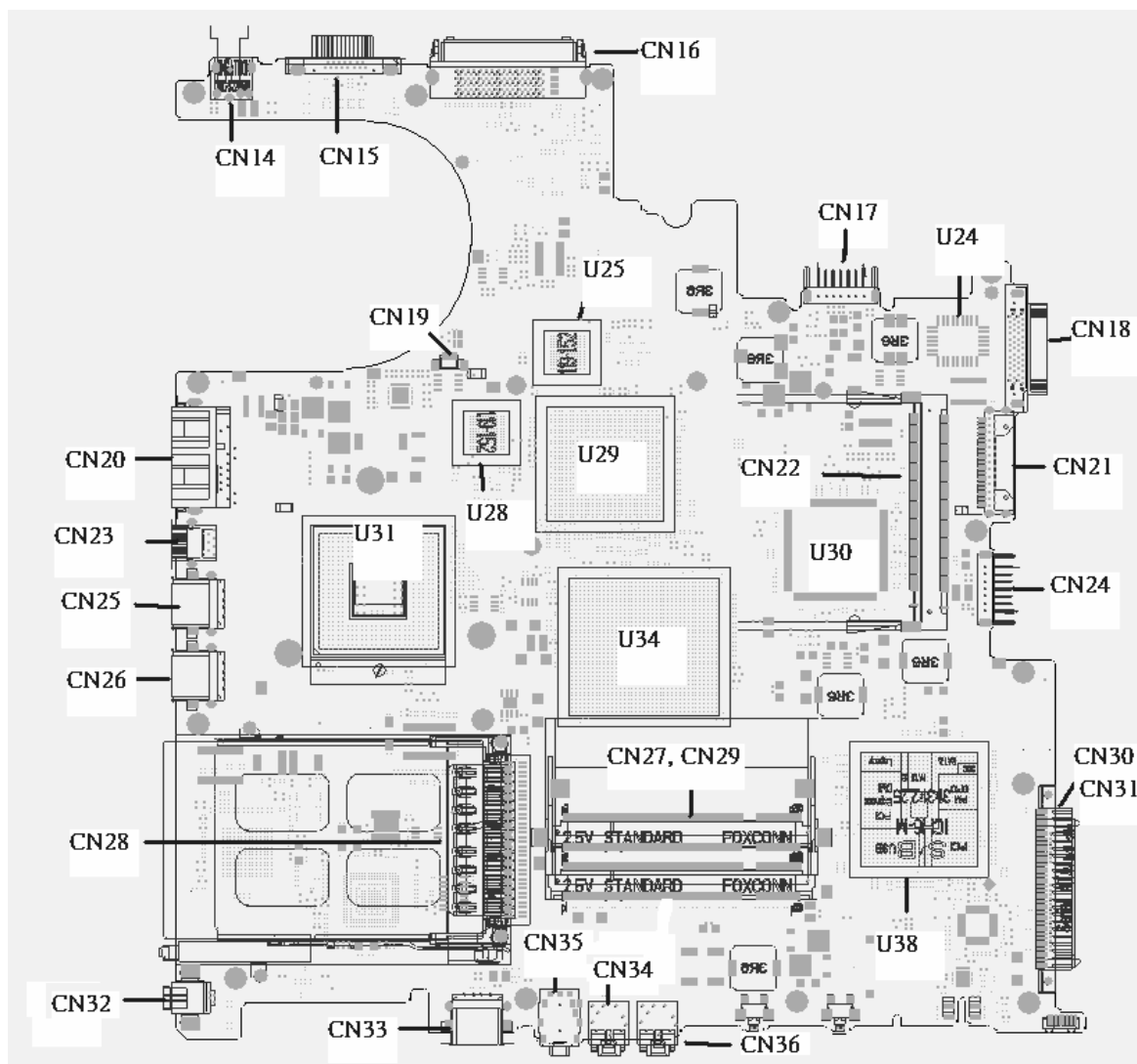

Rear View

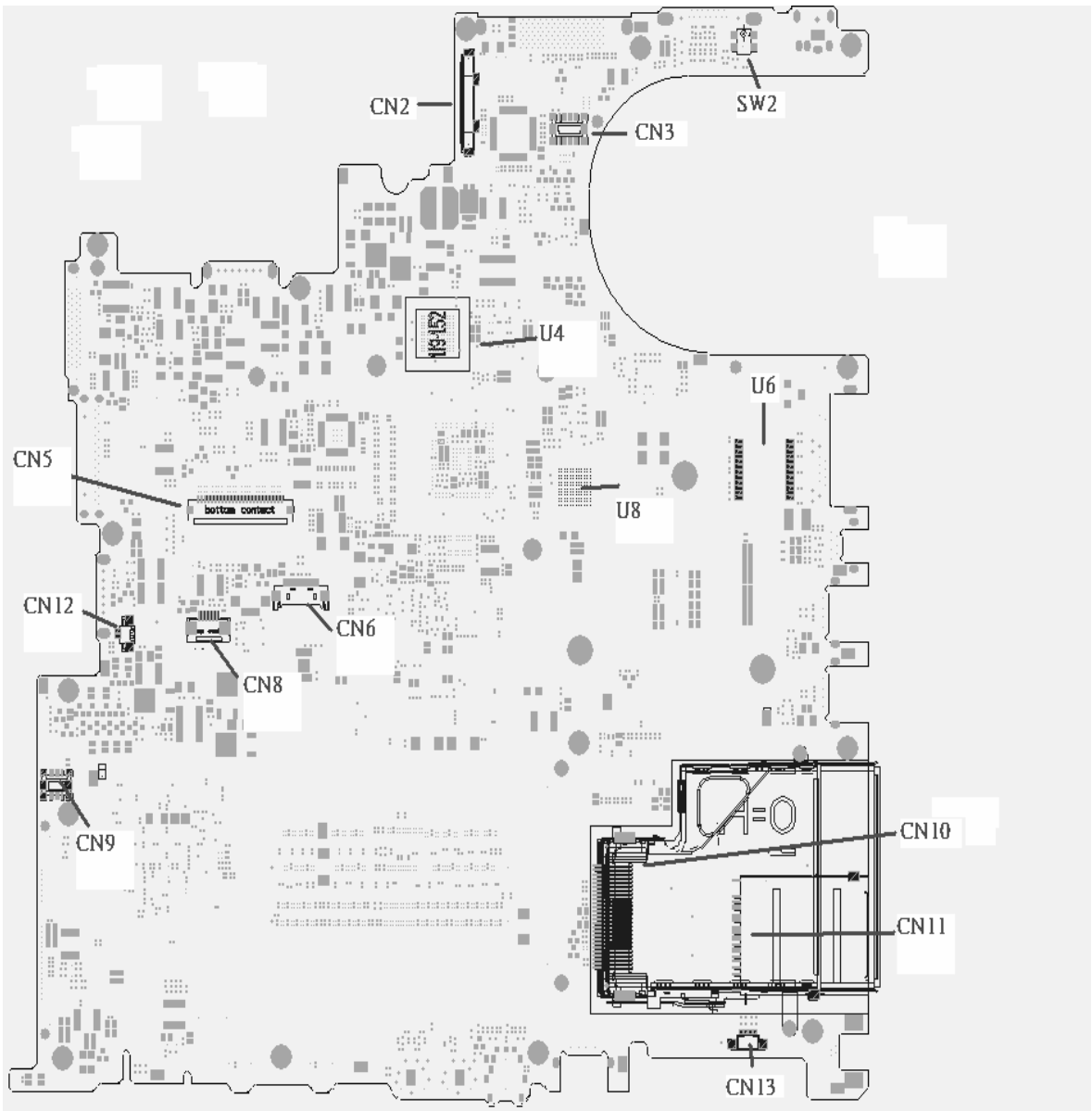

ITEM	DESCRIPTION	ITEM	DESCRIPTION
CN2	LCD Connector	CN14	DC JACK
CN3	LED board connector	CN15	CRT connector
SW2	Lid switch	CN16	Docking connector
CN10	express card connector	CN17	Battery connector
CN11	4 IN 1 connector	CN18	Fix ODD connector
CN13	Speaker connector	CN21	Swap ODD connector
CN9	MD board connector	CN24	2nd Battery connector
CN12	INT MIC connector	CN30	PATA HDD connector

ITEM	DESCRIPTION	ITEM	DESCRIPTION
CN5	Keyboard connector	CN31	SATA HDD connector
CN6	BT connector	CN36	Line IN connector
CN8	TP connector	CN34	MIC IN connector
U4	VGA RAM	CN35	Line out/SPDIF connector
U8	VGA RAM	CN33	USB connector
U6	LAN transformer	CN32	1394 connector
CN28	PCMCIA connector	CN26	USB connector
CN25	USB connector	CN23	S video connector
CN20	RJ45/RJ11 connector	CN19	Fan connector
CN22	MINI PCI connector	U31	CPU
U30	EC	U29	VGA Chp
U34	North Bridge	U38	South Bridge
U25	VGA RAM	U28	VGA RAM
U24	BIOS ROM		

RTC Jumper

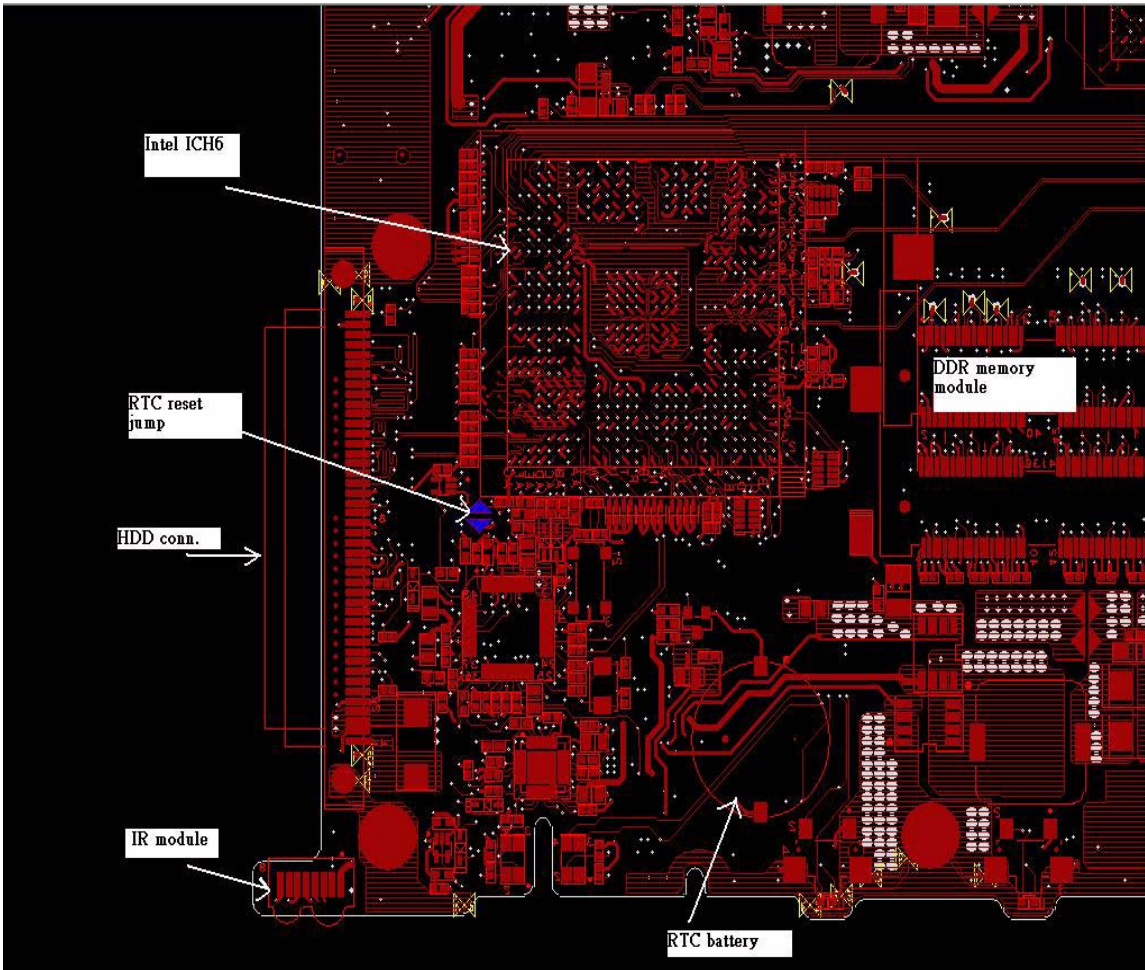

FRU (Field Replaceable Unit) List

This chapter gives you the FRU (Field Replaceable Unit) listing in global configurations of Aspire 1650. Refer to this chapter whenever ordering for parts to repair or for RMA (Return Merchandise Authorization).

Please note that WHEN ORDERING FRU PARTS, you should check the most up-to-date information available on your regional web or channel. For whatever reasons a part number change is made, it will not be noted on the printed Service Guide. For ACER AUTHORIZED SERVICE PROVIDERS, your Acer office may have a DIFFERENT part number code from those given in the FRU list of this printed Service Guide. You MUST use the local FRU list provided by your regional Acer office to order FRU parts for repair and service of customer machines.

NOTE: To scrap or to return the defective parts, you should follow the local government ordinance or regulations on how to dispose it properly, or follow the rules set by your regional Acer office on how to return it.

Exploded Diagram

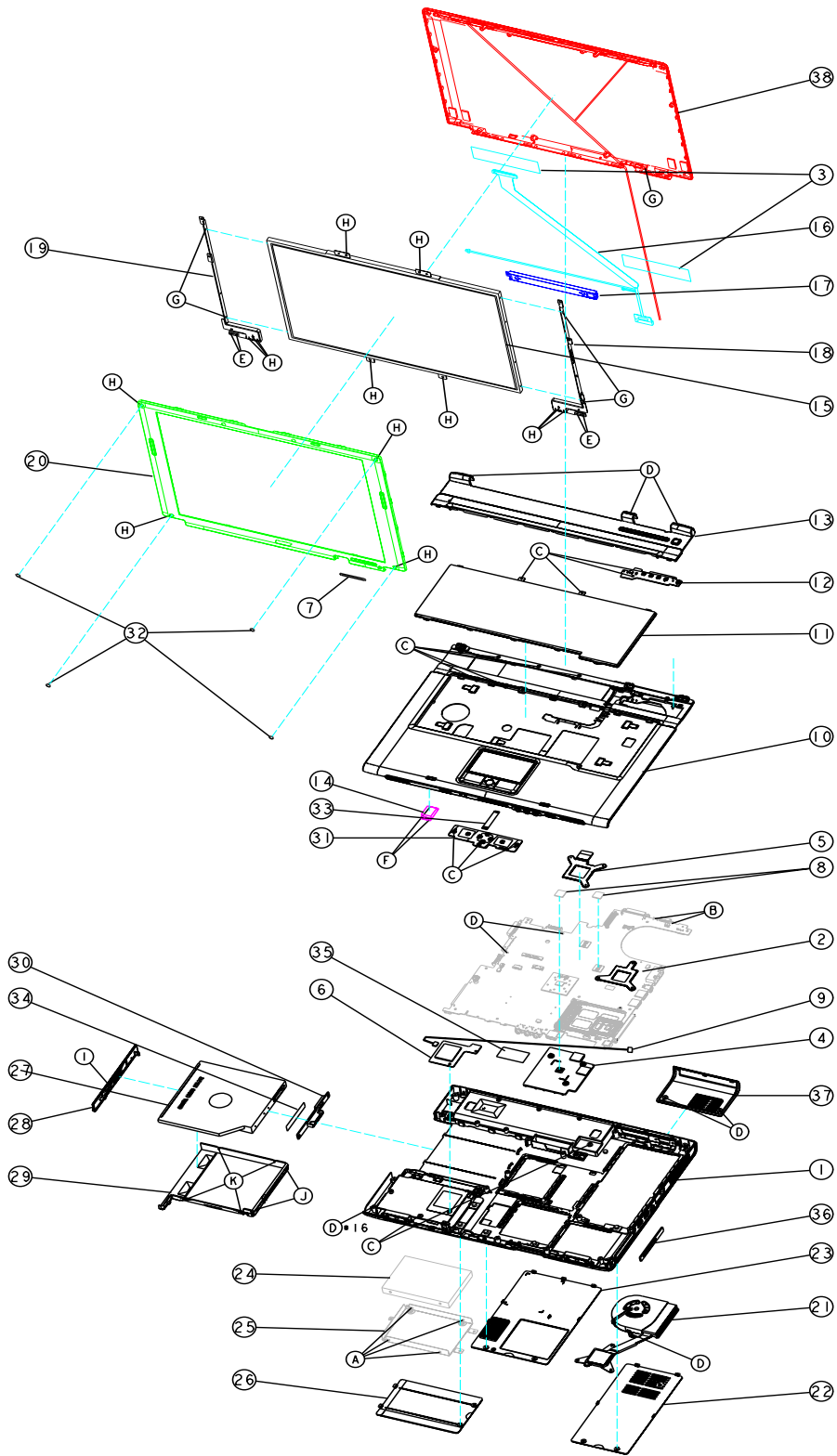







Illustration	Part Name	Description	Acer P/N
Adapter			
	ADAPTER 65W 3 PIN DELTA SADP-65KB BFD	TBD	AP.06501.005
	ADAPTER 65W 3 PIN LITE-ON PA-1650-02 Q2 19V	TBD	AP.06503.006
	ADAPTER 65W 3 PIN HIPRO HP- OK066B13QT	TBD	AP.06506.001
Battery			
	BATTERY SANYO LI- ION 4S2P 4.4A 4UR18650F-2-QC140	ZL1A BATTERY (SANYO 8 CELL) S.P.	BT.T5003.001
	BATTERY PANASONIC LI-ION 4S2P 4.4A CGR-B/8B5AE	ZL1A BATTERY (PANASONIC 8 CELL) S.P	BT.T5005.001
	BATTERY SIMPLO LI- ION 4S2P 4.4A 916- 3020	ZL1A BATTERY (SIMPLO 8 CELL) S.P.	BT.T5007.001
Board			
	MODEM BOARD	ZL1A MODEM BOARD ASSY S.P.	54.T50V7.001
	BLUETOOTH MODULE W/ANTENNA	ZA1 BLUETOOTH MODULE S/P (WITH BT ANTENNA)	54.T48V7.001
	WIRELESS LAN BOARD (802.11b+g) INTEL	ZG1S 802.11b+g SPARE PART-Intel	KI.CAX01.008
	LAUNCH BOARD	ZL1A LEB BOARD ASY S.P.	55.T50V7.001





Illustration	Part Name	Description	Acer P/N
	TOUCH PAD BOARD	ZL1A TOUCH PAD BOARD ASSY S.P.	55.T50V7.002
Cable			
	FFC CABLE - TP/B TO MB	ZL1A TOUCH PAD BOARD M/B (FFC) ASSY S.P.	50.T50V7.001
	MODEM CABLE	ZL1A MODEM CABLE ASSY S.P.	50.T50V7.002
	POWER CORD US (3 PIN)	ET2S POWER CORD S/P-US	27.A03V7.001
	POWER CORD PRC (3 PIN)	ET2S POWER CORD S/P-PRC	27.A03V7.003
	POWER CORD KOERA (3 Pin)	ZI1S POWER CORD SPARE PART-KOERA	27.T23V7.006
	POWER CORD EU (3 PIN)	ET2S POWER CORD S/P-EU	27.A03V7.002
	POWER CORD UK (3 PIN)	ET2S POWER CORD S/P-UK	27.A03V7.004
	POWER CORD ITALIAN (3 PIN)	ET2S POWER CORD S/P-ITALIAN	27.A03V7.005
	POWER CORD-SWISS	ET2S POWER CORD SPARE PART-SWISS	27.A03V7.007
	POWER CORD AU (3 PIN)	ET2S POWER CORD S/P-AU	27.A03V7.008
	POWER CORD DANISH (3 PIN)	ET2S POWER CORD S/P-DANISH	27.A03V7.006
	POWER CORD AF (3 PIN)	ZI5 POWER CORD S/ P-AF	27.T48V7.001
Case/Cover/Bracket Assembly			
	MIDDLE COVER ERGO W/BUTTON - LIGHT GREEN SILVER	ZL1 KB LCD COVER-TM-NEW ASSY	42.T50V7.101





Illustration	Part Name	Description	Acer P/N
	LOWER CASE W/ SPEAKER W/O 1394	ZL3A BASE ASSY W/O 1394 S/P	60.TAHV7.001
	UPPER CASE W/TP, BRACKET, MIC,BLUETOOTH CABLE W/O IR DIMM/WIRELESS COVER	ZL2 TOP COVER TM ASSY W/O IR ZL1 DDR COVER ASSY	60.TAHV7.002 42.T63V7.001
	HEATSINK COVER	ZL2 HEATSINK COVER W/O DOCKING ASSY	42.T66V7.001
	3 IN 1 DUMMY COVER	ZL1A 3 IN 1DUMMY COVER ASSY S.P.	42.T51V7.002
	HDD COVER	ZL2 HDD COVER ASSY	42.T63V7.004
	HDD BRACKET	ZL1A HDD BRACKET ASSY S.P.	33.T50V7.001
Communication Module			
	WIRELESS LAN ANTENNA	ZL1A WIRELESS ANTENNA ASSY S.P.	50.T50V7.003
CPU/Processor			
	INTEL PENTIUM M 1.5G 2M 400FSB uFCPGA2 SL6F9 B-1 STEPPING		KC.N0001.715
	INTEL PENTIUM M 1.6G 2M 400FSB uFCPGA2 SL7EG B-1 STEPPING		KC.N0001.725
	INTEL PENTIUM M 1.7G 2M 400FSB uFCPGA2 SL7EP B-1 STEPPING		KC.N0001.735
	INTEL PENTIUM M 1.8G 2M 400FSB uFCPGA2 SL7EN B-1 STEPPING		KC.N0001.745
	INTEL PENTIUM M 2.0G 2M 400FSB uFCPGA2 SL7EM B-1 STEPPING		KC.N0001.755
Optical Disk Drive Module			
	DVD/CDRW COMBO MODULE 24X QSI SBW-242C SWAP	ZL1 COMBO (QSI SBW-242C) W/MB ASSY S.P.	6M.T50V7.001

Illustration	Part Name	Description	Acer P/N
	DVD/CDRW COMBO DRIVE 24X QSI SBW-242C	ZI6 COMBO SBW-242C S/P-QSI	KO.02407.014
	OPTICAL DEVICE CONNECTOR BOARD W/MYLARY	ZL1 CD ROM/B ASSY S.P.	55.T50V7.003
	OPTICAL DEVICE HOLDER-SWAP	ZL1 DVD HOLDER ASSY S.P.	42.T50V7.007
	DVD/CDRW BEZEL FOR QSI	ZL1A COMBO BEZEL (QSI) ASSY S.P.	42.T50V7.008
	DVD/CDRW COMBO MODULE KME UJDA-760 SWAP	ZL1 COMBO (KME UJDA-760) W/MB ASSY S.P.	6M.T50V7.002
	DVD/CDRW COMBO DRIVE 24X KME UJDA-760	ZL1A COMBO (KME UJDA-760) S.P.	KO.02406.008
	OPTICAL DEVICE CONNECTOR BOARD W/MYLARY	ZL1 CD ROM/B ASSY S.P.	55.T50V7.003
	OPTICAL DEVICE HOLDER-SWAP	ZL1 DVD HOLDER ASSY S.P.	42.T50V7.007
	DVD/CDRW BEZEL FOR KME	ZL1A COMBO BEZEL (KME) ASSY S.P.	42.T50V7.009
	DVD DUAL MODULE QSI SDW-082 SWAP	ZL2 DVD DUAL (QSI SDW-082) W/MB ASSY S/P	TBD
	DVD DUAL DRIVE QSI SDW-082 F/W : ?	ZL1A DVD DUAL (QSI SDW-082) S.P.	TBD
	OPTICAL DEVICE CONNECTOR BOARD W/MYLARY	ZL1 CD ROM/B ASSY S.P.	55.T50V7.003
	OPTICAL DEVICE HOLDER-SWAP	ZL1 DVD HOLDER ASSY S.P.	42.T50V7.007
	DVD DUAL BEZEL FOR QSI	ZL1A DVD DUAL BEZEL (QSI) ASSY S.P.	42.T50V7.010
	DVD DUAL MODULE PIONEER DVR-K15RA G BASE	ZL3 DVD DUALPIONEER (DVR-K15RA) ASSY W/OMB S/P	6M.A51V7.002
	DVD DUAL DRIVE PIONEER DVR-K15RA D. LAYER G BASE	ZL2 DVD DUAL PIONEER (DVR-K15RA) S.P.	KU.00805.012
	OPTICAL DEVICE HOLDER-FIX	ZL1A DVD HOLDER (FIX) ASSY S.P.	42.T51V7.003
	DVD DUAL BEZEL G BASE	ZL1 DVD DUAL BEZEL ASSY W/P (GB) S/P	42.A51V7.005
	DVD DUAL MODULE LITE-ON SOSW-833 DL G BASE	ZL6 DVD DAUL (L/O,SOSW-833) ASSY S.P.	6M.T66V5.003

Illustration	Part Name	Description	Acer P/N
	DVD DUAL DRIVE LITE-ON SOSW-833 DL G BASE	ZL6 DVD RW(DUAL) SOSW-833S S.P.	KU.00804.012
	OPTICAL DEVICE CONNECTOR BOARD W/MYLARY	ZL1 CD ROM/B ASSY S.P.	55.T50V7.003
	OPTICAL DEVICE HOLDER-SWAP	ZL1 DVD HOLDER ASSY S.P.	42.T50V7.007
	DVD DUAL BEZEL FOR LITE-ON	ZL1A DVD DUAL BEZEL (LITON) ASSY S.P.	42.T50V7.012
HDD/Hard Disk Drive			
	Toshiba PLUTO 40G 4200rpm MK4025GAS ,KA100A F/W:KA100A	Toshiba PLUTO 40G 4200rpm MK4025GAS ,KA100A F/W:KA100A	KH.04004.002
	SEAGATE 40G 4200rpm ST94019A, 2MB F/W:3.05	SEAGATE 40G 4200rpm ST94019A, 2MB F/W:3.05	KH.04001.010
	TOSHIBA PLUTO 60GB 4200RPM, MK6025GAS	HGST MORAGA 60GB 4200RPM, IC25N060ATMR04-0 08K0634	KH.06007.006
	TOSHIBA PLUTO 60GB 4200RPM, MK6025GAS	TOSHIBA PLUTO 60GB 4200RPM, MK6025GAS	KH.06004.003
	SEAGATE N2 (50) 60GB 4200RPM, ST960821A	SEAGATE N2 (50) 60GB 4200RPM, ST960821A	KH.06001.002
	HGST MORAGA 80GB 4200RPM, IC25N080ATMR04-0 08K635	HGST MORAGA 80GB 4200RPM, IC25N080ATMR04-0 08K635	KH.08007.007
	TOSHIBA PLUTO 80GB 4200RPM, MK8025GAS, 8MB	TOSHIBA PLUTO 80GB 4200RPM, MK8025GAS, 8MB	KH.08004.001
	SEAGATE N2 (50) 80GB 4200RPM, ST9808210A	SEAGATE N2 (50) 80GB 4200RPM, ST9808210A	KH.08001.012
	TOSHIBA PROTEUS 60GB 5400RPM, MK6026GAX PA202G	TOSHIBA PROTEUS 80GB 5400RPM, MK8026GAX	KH.06004.002
	HGST MORAGA+ 60GB 5400RPM, HTS541060G9AT00 A56J	HGST MORAGA+ 60GB 5400RPM, HTS541060G9AT00	KH.06007.008
	HGST MORAGA+ 80GB 5400RPM, HTS541080G9AT00	HGST MORAGA+ 80GB 5400RPM, HTS541080G9AT00	KH.08007.009
	TOSHIBA PROTEUS 80GB 5400RPM, MK8026GAX	TOSHIBA PROTEUS 80GB 5400RPM, MK8026GAX	KH.08004.002

Illustration	Part Name	Description	Acer P/N
Keyboard			
	TM4500/TM4000/ TM2300 KEYBOARD DARFON US International	ZL1A K/B EUGO-U/I ASSY S.P.	KB.T5007.001
	TM4500/TM4000/ TM2300 KEYBOARD DARFON Chinese	ZL1A K/B ERGO- TAIWAN ASSY S.P.	KB.T5007.002
	TM4500/TM4000/ TM2300 KEYBOARD DARFON Spanish	ZL1A K/B EUGO- SPANISH ASSY S.P.	KB.T5007.003
	TM4500/TM4000/ TM2300 KEYBOARD DARFON Thai	ZL1A K/B EUGO-THAI ASSY S.P.	KB.T5007.004
	TM4500/TM4000/ TM2300 KEYBOARD DARFON Brazilian Protugese	ZL1A K/B EUGO-BRAZ PROTUG ASSY S.P.	KB.T5007.005
	TM4500/TM4000/ TM2300 KEYBOARD DARFON Korea	ZL1A K/B EUGO- KOREA ASSY S.P.	KB.T5007.006
	TM4500/TM4000/ TM2300 KEYBOARD DARFON UK	ZL1A K/B EUGO-U/I U.K.ASSY S.P.	KB.T5007.007
	TM4500/TM4000/ TM2300 KEYBOARD DARFON German	ZL1A K/B EUGO- GERMAN ASSY S.P.	KB.T5007.008
	TM4500/TM4000/ TM2300 KEYBOARD DARFON Italian	ZL1A K/B EUGO- ITALIAN ASSY S.P.	KB.T5007.009
	TM4500/TM4000/ TM2300 KEYBOARD DARFON French	ZL1A K/B EUGO- FRENCH ASSY S.P.	KB.T5007.010
	TM4500/TM4000/ TM2300 KEYBOARD DARFON Swiss/G	ZL1A K/B EUGO- SWISS/G ASSY S.P.	KB.T5007.011
	TM4500/TM4000/ TM2300 KEYBOARD DARFON Portuguese	ZL1A K/B EUGO- PORTUG ASSY S.P.	KB.T5007.012
	TM4500/TM4000/ TM2300 KEYBOARD DARFON Arabic	ZL1A K/B EUGO- ARABIC ASSY S.P.ZL1A K/B EUGO- ARABIC ASSY S.P.	KB.T5007.013
	TM4500/TM4000/ TM2300 KEYBOARD DARFON Belgium	ZL1A K/B EUGO- BELGIUM ASSY S.P.	KB.T5007.014
	TM4500/TM4000/ TM2300 KEYBOARD DARFON Sweden	ZL1A K/B EUGO- SWEDEN ASSY S.P.	KB.T5007.015
	TM4500/TM4000/ TM2300 KEYBOARD DARFON Czech	ZL1A K/B EUGO- CZECH ASSY S.P.	KB.T5007.016
	TM4500/TM4000/ TM2300 KEYBOARD DARFON Hungaian	ZL1A K/B EUGO-HUNG ASSY S.P.	KB.T5007.017

Illustration	Part Name	Description	Acer P/N
	TM4500/TM4000/ TM2300 KEYBOARD DARFON Norway	ZL1A K/B EUGO- NORWAY ASSY S.P.	KB.T5007.018
	TM4500/TM4000/ TM2300 KEYBOARD DARFON Danish	ZL1A K/B EUGO- DANISH ASSY S.P.	KB.T5007.019
	TM4500/TM4000/ TM2300 KEYBOARD DARFON Turkish	ZL1A K/B EUGO- TURKISH ASSY S.P.	KB.T5007.020
	TM4500/TM4000/ TM2300 KEYBOARD DARFON Canadian French	ZL1A K/B EUGO-CANA FREN ASSY S.P.	KB.T5007.021
	TM4500/TM4000/ TM2300 KEYBOARD DARFON Japanese	ZL1A K/B EUGO- JAPAN ASSY S.P.	KB.T5007.022
	TM4500/TM4000/ TM2300 KEYBOARD DARFON Greek	ZL1A K/B EUGO- GREEK ASSY S.P.	KB.T5007.023
	TM4500/TM4000/ TM2300 KEYBOARD DARFON Hebrew	ZL1A K/B EUGO- HEBREW ASSY S.P.	KB.T5007.024
	TM4500/TM4000/ TM2300 KEYBOARD DARFON Russian	ZL1A K/B EUGO-RUSS ASSY S.P.	KB.T5007.025
LCD			
	LCD MODULE 15 IN. SXGA CMO N150P2- L04 - LIGHT GREEN SILIVER	ZL1 15" LCD SXGA+ (TM-CMO) ASSY S.P. NEW COLOR	6M.T50V7.026
	LCD 15" TFT SXGA+ CMO N150P2-L04	ZI3 15" SXGA LCD S/P- CMO	LK.1500D.003
	LCD INVERTER BOARD	ZL1A LCD INVERTER ASSY S.P.	19.T50V7.001
	LCD CABLE - 15 IN. XGA	ZL1A 15" LCD CABEL XGA ASSY S.P.	50.T50V7.004
	LCD BRACKET W/ HINGE 15 IN. - L	ZL1A 15" LCD HINGE (L) ASSY S.P.	33.T50V7.002
	LCD BRACKET W/ HINGE 15 IN. - R	ZL1A 15" LCD HINGE (R) ASSY S.P.	33.T50V7.003
	LCD BEZEL W/ RUBBER PAD 15 IN.	ZL1A 15" LCD BEZEL ASSY S.P.	60.T50V7.004
	LCD PANEL W/LOGO ANTENNA 14/15 IN.- LIGHT GREEN SILVER	ZL1A 14/15" LCD COVER TM ASSY S.P. NEW COLOR	60.T50V7.102

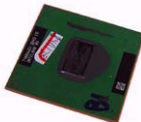
Illustration	Part Name	Description	Acer P/N
	LCD MODULE 15 IN. SXGA AU B150PG03 - LIGHT GREEN SILVER	ZL1 15" LCD SXGA+ (TM-AU) ASSY S.P. NEW COLOR	6M.T63V7.011
	LCD 15" TFT SXGA+ AU B150PG03 (NOVATEC)	ZI1S 15" SXGA+ LCD PANEL S/P-AU	LK.15005.008
	LCD INVERTER BOARD	ZL1A LCD INVERTER ASSY S.P.	19.T50V7.001
	LCD CABLE - 15 IN. XGA	ZL1A 15" LCD CABEL XGA ASSY S.P.	50.T50V7.004
	LCD BRACKET W/ HINGE 15 IN. - L	ZL1A 15" LCD HINGE (L) ASSY S.P.	33.T50V7.002
	LCD BRACKET W/ HINGE 15 IN. - R	ZL1A 15" LCD HINGE (R) ASSY S.P.	33.T50V7.003
	LCD BEZEL W/ RUBBER PAD 15 IN.	ZL1A 15" LCD BEZEL ASSY S.P.	60.T50V7.004
	LCD PANEL W/LOGO ANTENNA 14/15 IN.- LIGHT GREEN SILVER	ZL1A 14/15" LCD COVER TM ASSY S.P. NEW COLOR	60.T50V7.102
	LCD MODULE 15 IN. SXGA SAMSUNG LTN150P4-L03 - LIGHT GREEN SILVER	ZL1 15" LCD SXGA+(TM-SAM) ASSY S.P. NEW CO;OR	6M.T50V7.028
	LCD 15 IN. TFT SXGA+ SAMSUNG LTN150P4- L03 (150nit)	ZI6 15" SXGA+ LCD S/ P-SAMSUNG	LK.15006.006
	LCD INVERTER BOARD	ZL1A LCD INVERTER ASSY S.P.	19.T50V7.001
	LCD CABLE - 15 IN. XGA	ZL1A 15" LCD CABEL XGA ASSY S.P.	50.T50V7.004
	LCD BRACKET W/ HINGE 15 IN. - L	ZL1A 15" LCD HINGE (L) ASSY S.P.	33.T50V7.002
	LCD BRACKET W/ HINGE 15 IN. - R	ZL1A 15" LCD HINGE (R) ASSY S.P.	33.T50V7.003
	LCD BEZEL W/ RUBBER PAD 15 IN.	ZL1A 15" LCD BEZEL ASSY S.P.	60.T50V7.004
	LCD PANEL W/LOGO ANTENNA 14/15 IN.- LIGHT GREEN SILVER	ZL1A 14/15" LCD COVER TM ASSY S.P. NEW COLOR	60.T50V7.102

Illustration	Part Name	Description	Acer P/N
	LCD MODULE 15.4 IN. WXGA QDI QD15TL02-01-LIGHT GREEN SILVER	ZL1A 15.4" LCD WXGA (TM QDI) ASSY S.P. NEW COLOR	6M.T50V7.029
	LCD 15.4 IN. WXGA QDI QD15TL02-01	ZL1A 15.4" LCD (QDI) PANEL ASSY S.P.	LK.15409.001
	LCD INVERTER BOARD	ZL1A LCD INVERTER ASSY S.P.	19.T50V7.001
	LCD CABLE - 15.4 IN. WXGA	ZL1A 15.4" LCD WXGA CABEL ASSY S.P.	50.T50V7.006
	LCD BRACKET W/ HINGE 15.4 IN. - L	ZL1A 15.4" LCD HINGE (L) ASSY S.P.	33.T50V7.004
	LCD BRACKET W/ HINGE 15.4 IN. - R	ZL1A 15.4" LCD HINGE (R) ASSY S.P.	33.T50V7.005
	LCD BEZEL W/ RUBBER PAD 15.4 IN.	ZL1A 15.4" LCD BEZEL ASSY S.P.	60.T50V7.006
	LCD PANEL W/LOGO ANTENNA 15.4 IN.- LIGHT GREEN SILVER	ZL1A 15.4" LCD (TM) COVER ASSY S.P. NEW COLOR	60.T50V7.103
	LCD MODULE 15.4 IN. WXGA LG LP154W01-A5 1-LIGHT GREEN SILVER	ZL2 15.4" LCD WXGA (TM LG) ASSY S.P. NEW COLOR	6M.T63V7.012
	LCD 15.4 IN. WXGA LG LP154W01-A5	ZL2 15.4" LCD (LG) PANEL ASSY S.P.	LK.15408.005
	LCD INVERTER BOARD	ZL1A LCD INVERTER ASSY S.P.	19.T50V7.001
	LCD CABLE - 15.4 IN. WXGA	ZL1A 15.4" LCD WXGA CABEL ASSY S.P.	50.T50V7.006
	LCD BRACKET W/ HINGE 15.4 IN. - L	ZL1A 15.4" LCD HINGE (L) ASSY S.P.	33.T50V7.004
	LCD BRACKET W/ HINGE 15.4 IN. - R	ZL1A 15.4" LCD HINGE (R) ASSY S.P.	33.T50V7.005
	LCD BEZEL W/ RUBBER PAD 15.4 IN.	ZL1A 15.4" LCD BEZEL ASSY S.P.	60.T50V7.006
	LCD PANEL W/LOGO ANTENNA 15.4 IN.- LIGHT GREEN SILVER	ZL1A 15.4" LCD (TM) COVER ASSY S.P. NEW COLOR	60.T50V7.103

Illustration	Part Name	Description	Acer P/N
	LCD MODULE 15.4 IN. WXGA CMO N15411-L09 V.C2-LIGHT GREEN SILVER	ZL2 15.4" LCD WXGA (TM CMO) ASSY S.P. NEW COLOR	6M.T63V7.013
	LCD 15.4 IN. WXGA CMO N15411-L09 V.C2	ZL2 15.4" LCD (CMO) PANEL ASSY S.P.	LK.1540D.003
	LCD INVERTER BOARD	ZL1A LCD INVERTER ASSY S.P.	19.T50V7.001
	LCD CABLE - 15.4 IN. WXGA	ZL1A 15.4" LCD WXGA CABEL ASSY S.P.	50.T50V7.006
	LCD BRACKET W/ HINGE 15.4 IN. - L	ZL1A 15.4" LCD HINGE (L) ASSY S.P.	33.T50V7.004
	LCD BRACKET W/ HINGE 15.4 IN. - R	ZL1A 15.4" LCD HINGE (R) ASSY S.P.	33.T50V7.005
	LCD BEZEL W/ RUBBER PAD 15.4 IN.	ZL1A 15.4" LCD BEZEL ASSY S.P.	60.T50V7.006
	LCD PANEL W/LOGO ANTENNA 15.4 IN.- LIGHT GREEN SILVER	ZL1A 15.4" LCD (TM) COVER ASSY S.P. NEW COLOR	60.T50V7.103
	LCD MODULE 15.4 IN. WXGA SAMSUNG LTN154X3-L01-LIGHT GREEN SILVER	ZL1A 15.4" LCD WXGA (TM QDI) ASSY S.P. NEW COLOR	6M.T63V7.014
	LCD 15.4 IN. WXGA SAMSUNG LTN154X3-L01	ZL2 15.4" LCD (SAMSUNG) PANEL ASSY S.P.	LK.15406.005
	LCD INVERTER BOARD	ZL1A LCD INVERTER ASSY S.P.	19.T50V7.001
	LCD CABLE - 15.4 IN. WXGA	ZL1A 15.4" LCD WXGA CABEL ASSY S.P.	50.T50V7.006
	LCD BRACKET W/ HINGE 15.4 IN. - L	ZL1A 15.4" LCD HINGE (L) ASSY S.P.	33.T50V7.004
	LCD BRACKET W/ HINGE 15.4 IN. - R	ZL1A 15.4" LCD HINGE (R) ASSY S.P.	33.T50V7.005
	LCD BEZEL W/ RUBBER PAD 15.4 IN.	ZL1A 15.4" LCD BEZEL ASSY S.P.	60.T50V7.006
	LCD PANEL W/LOGO ANTENNA 15.4 IN.- LIGHT GREEN SILVER	ZL1A 15.4" LCD (TM) COVER ASSY S.P. NEW COLOR	60.T50V7.103

Illustration	Part Name	Description	Acer P/N
	LCD MODULE 15.4 IN. WXGA HITACHI TX39D85VC1FAA-LIGHT GREEN SILVER	ZL1A 15.4" LCD WXGA (TM HITACHI) ASSY S.P. NEW COLOR	6M.T63V7.015
	LCD 15.4 IN. WXGA HITACHI TX39D85VC1FAA	ZL2 15.4" LCD (HITACHI) PANEL ASSY S.P.	LK.15404.003
	LCD INVERTER BOARD	ZL1A LCD INVERTER ASSY S.P.	19.T50V7.001
	LCD CABLE - 15.4 IN. WXGA	ZL1A 15.4" LCD WXGA CABEL ASSY S.P.	50.T50V7.006
	LCD BRACKET W/ HINGE 15.4 IN. - L	ZL1A 15.4" LCD HINGE (L) ASSY S.P.	33.T50V7.004
	LCD BRACKET W/ HINGE 15.4 IN. - R	ZL1A 15.4" LCD HINGE (R) ASSY S.P.	33.T50V7.005
	LCD BEZEL W/ RUBBER PAD 15.4 IN.	ZL1A 15.4" LCD BEZEL ASSY S.P.	60.T50V7.006
	LCD PANEL W/LOGO ANTENNA 15.4 IN.- LIGHT GREEN SILVER	ZL1A 15.4" LCD (TM) COVER ASSY S.P. NEW COLOR	60.T50V7.103
MAINBOARD			
	MAINBOARD 915GM UMA W/PCMCIA SLOT W/O CPU MEMORY	ZL3A M/B (UMA)ASSY S/P	LB.TAH06.001
MEMORY			
	MEMORY DDR333 256MB INFINEON HYS64D32020HDL-6-C (.11u)	MEMORY DDR333 256MB INFINEON HYS64D32020HDL-6-C (.11u)	KN.25602.012
	256M Micron SO-DIMM DDR333 256MB MT4VDDT3264HG-335C2	256M Micron SO-DIMM DDR333 256MB MT4VDDT3264HG-335C2	KN.25604.016
	MEMORY DDR333 256MB SAMSUNG M470L3224FT0-CB3	MEMORY DDR333 256MB SAMSUNG M470L3224FT0-CB3	KN.2560B.008
	MEMORY DDR333 256MB MICRON MT8VDDT3264HDG-335C3	MEMORY DDR333 256MB MICRON MT8VDDT3264HDG-335C3	KN.25604.009
	512MB Micron SO-DIMM DDR333 512MB MT8VDDT6464HDG-335C1 (.11u),	512MB Micron SO-DIMM DDR333 512MB MT8VDDT6464HDG-335C1 (.11u),	KN.51204.013
	MEMORY DDR333 512MB SAMSUNG M470L6524BT0-CB3	MEMORY DDR333 512MB SAMSUNG M470L6524BT0-CB3	KN.5120B.006

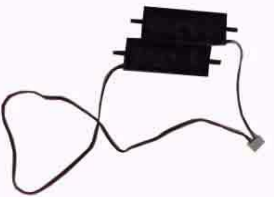

Illustration	Part Name	Description	Acer P/N
	SO-DIMM DDR333 512MB UNIFOSA U30512AAUIQ652AW2 0	SO-DIMM DDR333 512MB UNIFOSA U30512AAUIQ652AW2 0	KN.5120H.001
	MEMORY DDR333 1GB ELPIDA EBD11UD8ADDA	SO-DIMM DDR333 1GB ELPIDA EBD11UD8ADDA	KN.1GB09.002
SPEAKER			
	SPEAKER SET	ZL1A SPEAKER ASSY S.P.	23.T50V7.001
HEATSINK			
	THERMAL MODULE	ZL2 CPU HEATSINK ASSY	60.T63V7.003
	VGA HEATSINK FOR DISCRETE W/PAD	ZL2 SINK VGA ASSY W/ NB	34.T63V7.001
	VGA HEATSINK FOR DISCRETE W/PAD	ZL2 SINK VGA ASSY W/ NB	34.T63V7.001
	VGA HEATSINK FOR UMA W/PAD	ZL2 SINK VGA ASSY W/O NB	34.T63V7.002
MISCELLANEOUS			
	NAME PLATE - TM4020	ZL3A NAME PLATE S/ P	40.TAHV7.001
	RUBBER FOOT	ZL1A RUBBER FOOT S.P.	47.T50V7.002
	LCD SCREW RUBBER PAD	ZL1A RUBBER PAD- UP S.P.	47.T50V7.003
	LCD BEZEL RUBBER PAD	ZL1A RUBBER PAD-2 S.P.	47.T50V7.004
	WEIGHT SAVER	ZL1 WEIGHT SAVER S.P.	60.T50V7.008
	2nd HDD BASE W/ CONNECT	ZL1 2ND HDD BASE ASSY S.P.	60.T50V7.009
	2nd HDD COVER	ZL1 2ND HDD COVER ASSY S.P.	42.T50V7.015
	2nd HDD BRACKET KIT	ZL1 2ND BRACKET ASSY S.P.	6K.T50V7.001
SCREW			
	SCREW M2.0X3.0-I-NI- NYLOK	ET2S SCREW MM2.0X3.0 SPARE PART	86.A03V7.012
	SCREW I2.5*3M- BNIH(M2.5L3)	ZG1S I2.5*3M- BNIH(M2.5L3) S/P	86.T25V7.012

Illustration	Part Name	Description	Acer P/N
	SCREW M2.5*4L-BZN-NYLOK	ET2S SCREW MM2.5X4.0 SPARE PART	86.A03V7.006
	SCREW M2.0X5-I-NI-NYLOK	Z11S SCREW M2.0X5-I-NI-NYLOK S/P	86.T23V7.006
	SCREW MM25060IL69	DT1 SCREW MM25060IL69 SPARE PART	86.A08V7.004
	SCREW M2.0*5-I(NI)(NYLOK)	Z11S SCREW M2.5X5.0-I-NI-NYLOK S/P	86.T23V7.010
	SCREW M2.0X2.5-I-NI-NYLOK	ET2S SCREW MM2.0X2.5 SPARE PART	86.A03V7.007
	SCREW I2*3M-NIH(Y (M2L3)	ZG1S I2*3M-NIH(Y (M2L3) S/P	86.T25V7.008
	SCREW M1.7*3.0-I (BK)	ZL1A SCREW (M1.7*3.1-I (BK) S.P.	86.T50V7.001
	SCREW I3*3.5M-NIH(M3L3.5)	ET2S SCREW MM3.0X3.5 SPARE PART	86.A03V7.011

