

KA3511BS

Intelligent Voltage Mode PWM IC

Features

- Complete PWM control and house keeping circuitry
- Few external components
- Precision voltage reference trimmed to 2%
- Dual output for push-pull operation
- Each output TR for 200mA sink current
- Variable duty cycle by dead time control
- Soft start capability by using dead time control
- Double pulse suppression logic
- Over voltage protection for 3.3V / 5V / 12V
- Under voltage protection for 3.3V / 5V / 12V
- One more external input for various protection (PT)
- Remote on/off control function (PS-ON)
- Latch function controlled by remote and protection input
- Power good signal generator with hysteresis

Precision reference section

The reference voltage trimmed to $\pm 2\%$
($4.9V \leq V_{ref} \leq 5.1V$)

PG (Power good signal generator) section

Power good signal generator is to monitor the voltage level of power supply for safe operation of a microprocessor.

KA3511BS requires few external components to accomplish a complete housekeeping circuits for SMPS.

Description

The KA3511BS is a fixed-frequency improved-performance pulse-width modulation control circuit with complete housekeeping circuitry for use in the secondary side of SMPS (Switched mode power supply). It contains various functions, which are precision voltage reference, over voltage protection, under voltage protection, remote on/off control, power good signal generator and etc.

OVP (Over voltage protection) section

It has OVP functions for +3.3V, +5V, +12V and PT outputs. The circuit is made up of a comparator with four detecting inputs and without hysteresis voltage. Especially, PT (Pin18) is prepared for an extra OVP input or another protection signal.

UVP (Under voltage protection) section

It also has UVP functions for +3.3V, +5V, +12V outputs. The block is made up of a comparator with three detecting inputs and without hysteresis voltage.

Remote on/off section

Remote on/off section is used to control SMPS externally. If a high signal is supplied to the remote on/off input, PWM signal becomes a high state and all secondary outputs are grounded. The remote on/off signal is transferred with some on-delay and off-delay time of 8ms, 24ms respectively.

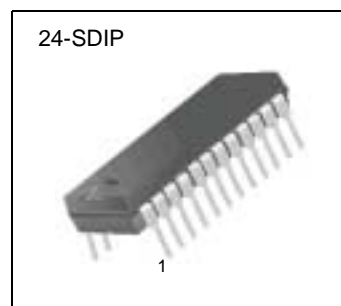

Internal Block Diagram

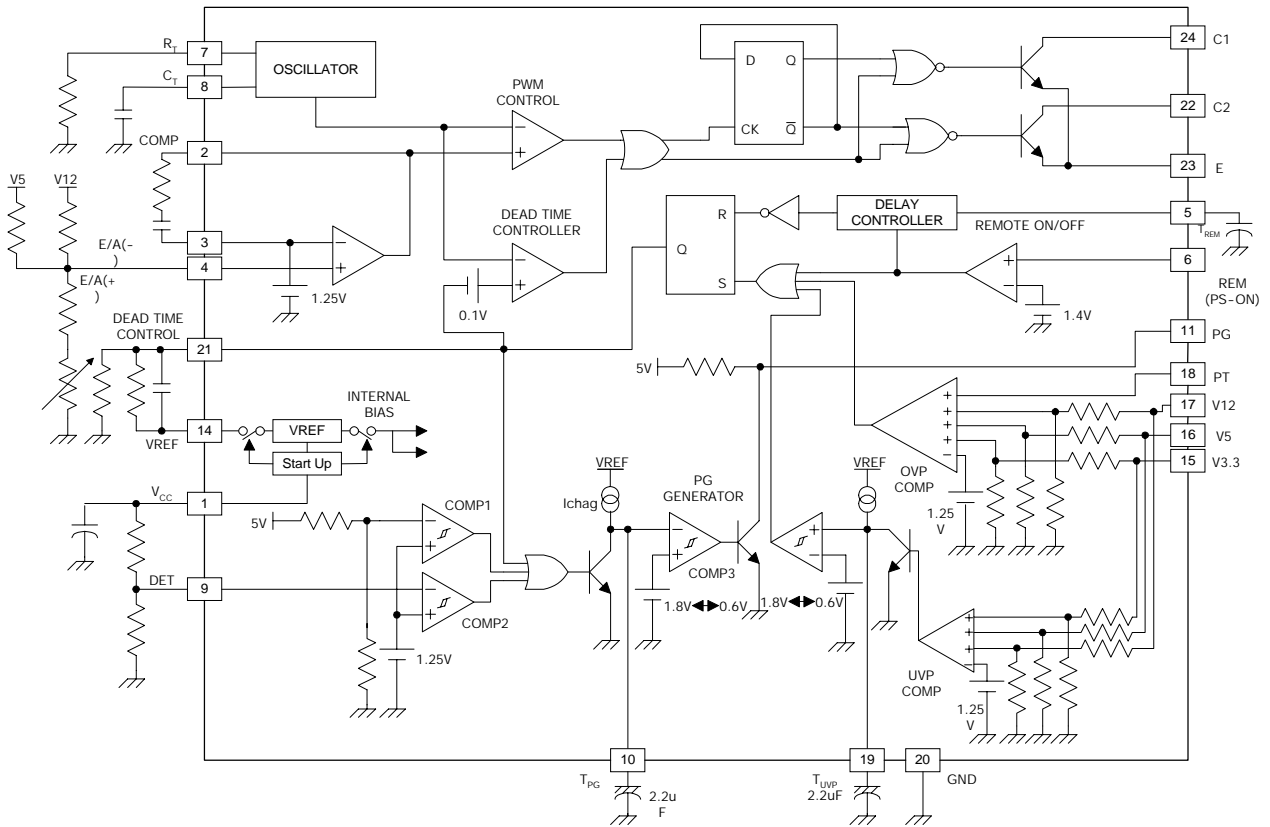

Absolute Maximum Ratings

Parameter	Symbol	Value	Unit
Supply voltage	VCC	40	V
Collector output voltage	VC1, VC2	40	V
Collector output current	IC1, IC2	200	mA
Power dissipation(KA3511BS)	PD	1.5	W
Operating temperature	TOPR	-25 to 85	°C
Storage temperature	TSTG	-65 to 150	°C

Temperature Characteristics

Parameter	Symbol	Value			Unit
		Min.	Typ.	Max.	
Temperature coefficient of Vref (-25°C ≤ Ta ≤ 85°C)	ΔVref/ΔT	-	0.01	-	%/°C

Pin Definition : KA3511BS

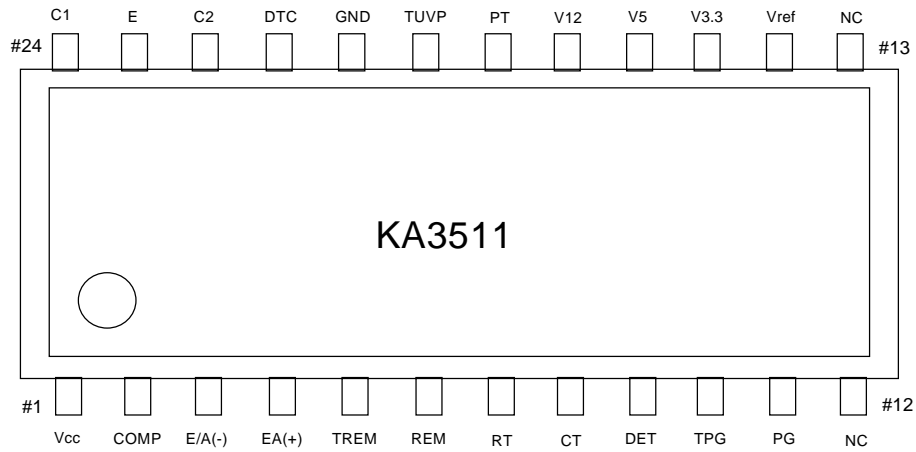

Pin Number	Pin Name	I/O	Pin Function	Pin Number	Pin Name	I/O	Pin Function Description
1	VCC	I	Supply voltage	13	NC	-	NC
2	COMP	O	E/A output	14	Vref	O	Precision reference VTG
3	E/A(-)	I	E/A (-) input	15	V3.3	I	OVP, UVP input for 3.3V
4	E/A(+)	I	E/A (+) input	16	V5	I	OVP, UVP input for 5V
5	TREM	-	Remote on/off delay	17	V12	I	OVP, UVP input for 12V
6	REM	I	Remote on/off input	18	PT	I	Extra protection input
7	RT	-	Oscillation freq. setting R	19	TUVp	-	UVP delay
8	CT	-	Oscillation freq. setting C	20	GND	-	Signal ground
9	DET	I	Detect input	21	DTC	I	Deadtime control input
10	TPG	-	PG delay	22	C2	O	Output 2
11	PG	O	Power good signal output	23	E	-	Power ground
12	NC	-	NC	24	C1	O	Output 1

Pin Number	Pin Name	Pin Function Description
1	VCC	Supply voltage. Operating range is 14V~30V. VCC=20V, Ta=25°C at test.
2	COMP	Error amplifier output. It is connect to non-inverting input of pulse width modulator comparator.
3	E/A(-)	Error amplifier inverting input. Its reference voltage is always 1.25V.
4	E/A(+)	Error amplifier non-inverting input feedback voltage. This pin may be used to sense power supply output voltage.
5	TREM	Remote on/off delay. Ton/Toff=8ms/24ms (Typ.) with C=0.1uF. Its high/low threshold voltage is 1.8V/0.6V.
6	REM	Remote on/off input. It is TTL operation and its threshold voltage is 1.4V. Voltage at this pin can reach normal 4.6V, with absolutely maximum voltage, 5.25V. If REM = "Low", PWM = "Low". That means the main SMPS is operational. When REM = "High", then PWM = "High" and the main SMPS is turned-off.
7	RT	Oscillation frequency setting R. (Test Condition RT=10kΩ)
8	CT	Oscillation frequency setting C. (Test Condition CT=0.01uF)
9	DET	Under-voltage detect pin. Its threshold voltage is 1.25V Typ.
10	TPG	PG delay. Td=250ms (Typ) with CPG=2.2uF. The high/low threshold voltage are 1.8V/0.6V and the voltage of Pin10 is clamped at 2.9V for noise margin.
11	PG	Power good output signal. PG = "High" means that the power is "Good" for operation and PG = "Low" means "Power fail".
14	Vref	Precision voltage reference trimmed to 2%. (Typical Value = 5.03V)
15	V3.3	Over voltage protection for output 3.3V. (Typical Value = 4.1V)
16	V5	Over voltage protection for output 5V. (Typical Value = 6.2V)
17	V12	Over voltage protection for output 12V. (Typical Value = 14.2V)
18	PT	This is prepared for an extra OVP input or another protection signal. (Typical Value = 1.25V)
19	TUVP	Timing pin for under voltage protection blank-out time. Its threshold voltage is 1.8V and clamped at 2.9V after full charging. Target of delay time is 250ms and it is realized through external (C=2.2uF).
20	GND	Signal ground.
21	DTC	Deadtime control input. The dead-time control comparator has an effective 120mV input offset which limits the minimum output dead time. Dead time may be imposed on the output by setting the dead time control input to a fixed voltage, ranging between 0V to 3.3V.
22	C2	Output drive pin for push-pull operation.
23	E	Power ground.
24	C1	Output drive pin for push-pull operation.

AElectrical Characteristics (v_{CC}=20V, t_a=25°C)

Parameter	Symbol	Condition	Value			Unit
			Min.	Typ.	Max.	
REFERENCE SECTION						
Reference output voltage	V _{ref}	I _{ref} =1mA	4.9	5	5.1	V
Line regulation	ΔV _{ref.LINE}	14V≤V _{CC} ≤30V	-	2.0	25	mV
Load regulation	ΔV _{ref.LOAD}	1mA≤I _{ref} ≤10mA	-	1.0	15	mV
Temperature coefficient of V _{ref} ⁽¹⁾	ΔV _{ref} /ΔT	-25°C≤T _a ≤85°C	-	0.01	-	%/°C
Short-circuit output current	I _{SC}	V _{ref} =0	15	35	75	mA
OSCILLATOR SECTION						
Oscillation frequency	f _{osc}	C _T =0.01μF, R _T =12k	-	10	-	kHz
Frequency change with temperature ⁽¹⁾	f _{osc} /T	C _T =0.01μF, R _T =12k	-	2	-	%
DEAD TIME CONTROL SECTION						
Input bias current	I _B (DT)	-	-	-2.0	-10	μA
Maximum duty voltage	DC _{MAX}	Pin19 (DTC)=0V	45	48	50	%
Input threshold voltage	V _{TH} (DT)	Zero Duty Cycle	-	3.0	3.3	V
		Max. Duty Cycle	0	-	-	
ERROR AMP SECTION						
Inverting reference voltage	V _{ref} (EA)	-	1.20	1.25	1.30	V
Input bias current	I _B (EA)	V _{COMP} =2.5V	-	-0.1	-1.0	μA
Open-loop voltage gain ⁽¹⁾	G _{VO}	0.5V≤V _{COMP} ≤3.5V	70	95	-	dB
Unit-gain bandwidth ⁽¹⁾	BW	-	-	650	-	kHz
Output sink current	I _{SINK}	V _{COMP} =0.7V	0.3	0.9	-	mA
Output source current	I _{SOURCE}	V _{COMP} =3.5V	-2.0	-4.0	-	mA
PWM COMPARATOR SECTION						
Input threshold voltage	V _{TH} (PWM)	Zero Duty Cycle	-	4	4.5	V
OUTPUT SECTION						
Output saturation voltage	V _{CE} (SAT)	I _C =200mA	-	1.1	1.3	V
Collector off-state current	I _C (off)	V _{CC} =V _C =30V, V _E =0V	-	2	100	μA
Rising time	T _R	-	-	100	200	ns
Falling time	T _F	-	-	50	200	ns
PROTECTION SECTION						
Over voltage protection for 3.3V	VOVP1	-	3.8	4.1	4.3	V

Electrical Characteristics (continued)

Parameter	Symbol	Condition	Value			Unit
			Min.	Typ.	Max.	
Over voltage protection for 5V	VOVP2	-	5.8	6.2	6.6	V
Over voltage protection for 12V	VOVP3	-	13.5	14.2	15.0	V
Input threshold voltage for PT	VPT	-	1.20	1.25	1.30	V
Under voltage protection for 3.3V	VUVP1	-	2.1	2.3	2.5	V
Under voltage protection for 5V	VUVP2	-	3.7	4.0	4.3	V
Under voltage protection for 12V	VUVP3	-	9.2	10	10.8	V
Charging current for UVP delay	I _{CHG.UVP}	C=2.2uF, V _{TH} =1.8V	-10	-15	-23	uA
UVP Delay Time	T _{D.UVP}	C=2.2uF	100	260	500	ms
REMOTE ON/OFF SECTION						
REM on input voltage	V _{REMH}	I _{REM} =-200uA	2.0	-	-	V
REM off input voltage	V _{REML}	-	-	-	0.8	V
REM off input bias voltage	I _{REML}	V _{REM} =0.4V	-	-	-1.6	mA
REM on open voltage	V _{REM(OPEN)}	-	2.0	-	5.25	V
REM on delay time	T _{on}	C=0.1uF	4	8	14	ms
REM off delay time	T _{off}	C=0.1uF	16	24	34	ms
REMOTE ON/OFF SECTION ⁽²⁾						
Detecting input voltage	V _{IN(DET)}	-	1.20	1.25	1.30	V
Detecting V5 voltage	V _{5(DET)}	-	4.1	4.3	4.5	V
Hysteresis voltage 1	HY1	COMP1, 2	10	40	80	mV
Hysteresis voltage 2	HY2	COMP3	0.6	1.2	-	V
PG output load resistor	R _{PG}	-	0.5	1	2	kΩ
Charging current for PG delay	I _{CHG.PG}	C=2.2uF, V _{TH} =1.8V	-10	-15	-23	uA
PG delay time	T _{D.PG}	C=2.2uF	100	260	500	ms
PG output saturation voltage	V _{SAT(PG)}	I _{PG} =10mA	-	0.2	0.4	V
TOTAL DEVICE						
Standby supply current	I _{CC}	-	-	10	20	mA

Notes:

1. These Parameters, although guaranteed over their recommended operating conditions are not 100% tested in production.
2. REM on delay time (Pin6 REM: "L" → "H"),
REM off delay time (Pin6 REM: "H" → "L")

Application Informations

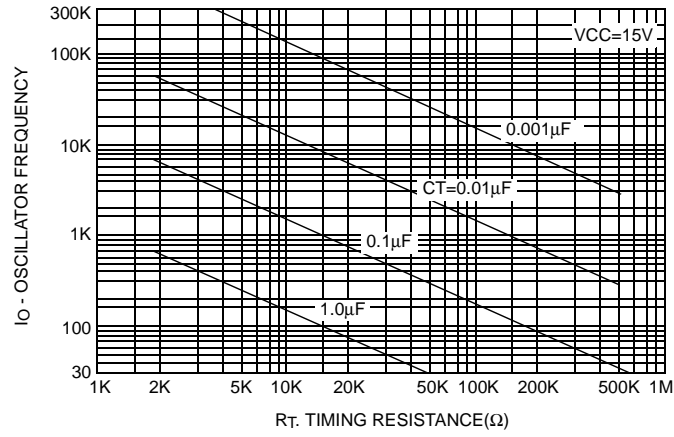

Figure 1. Oscillator Frequency vs. Timing Resistance

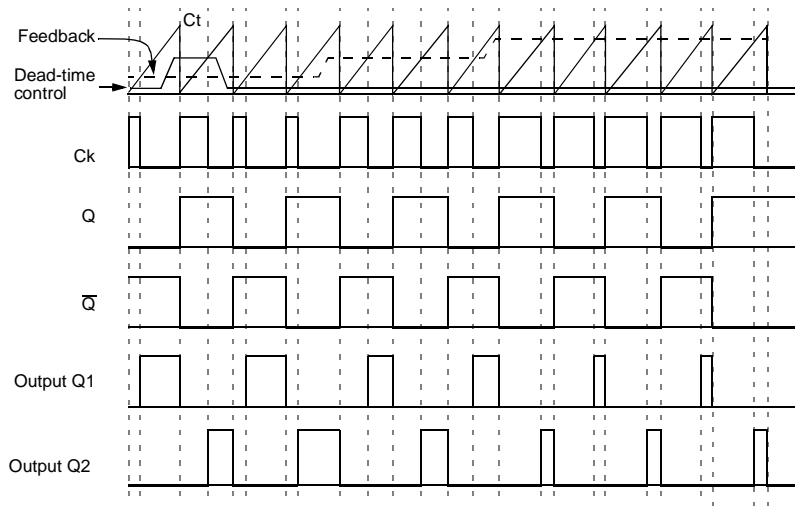
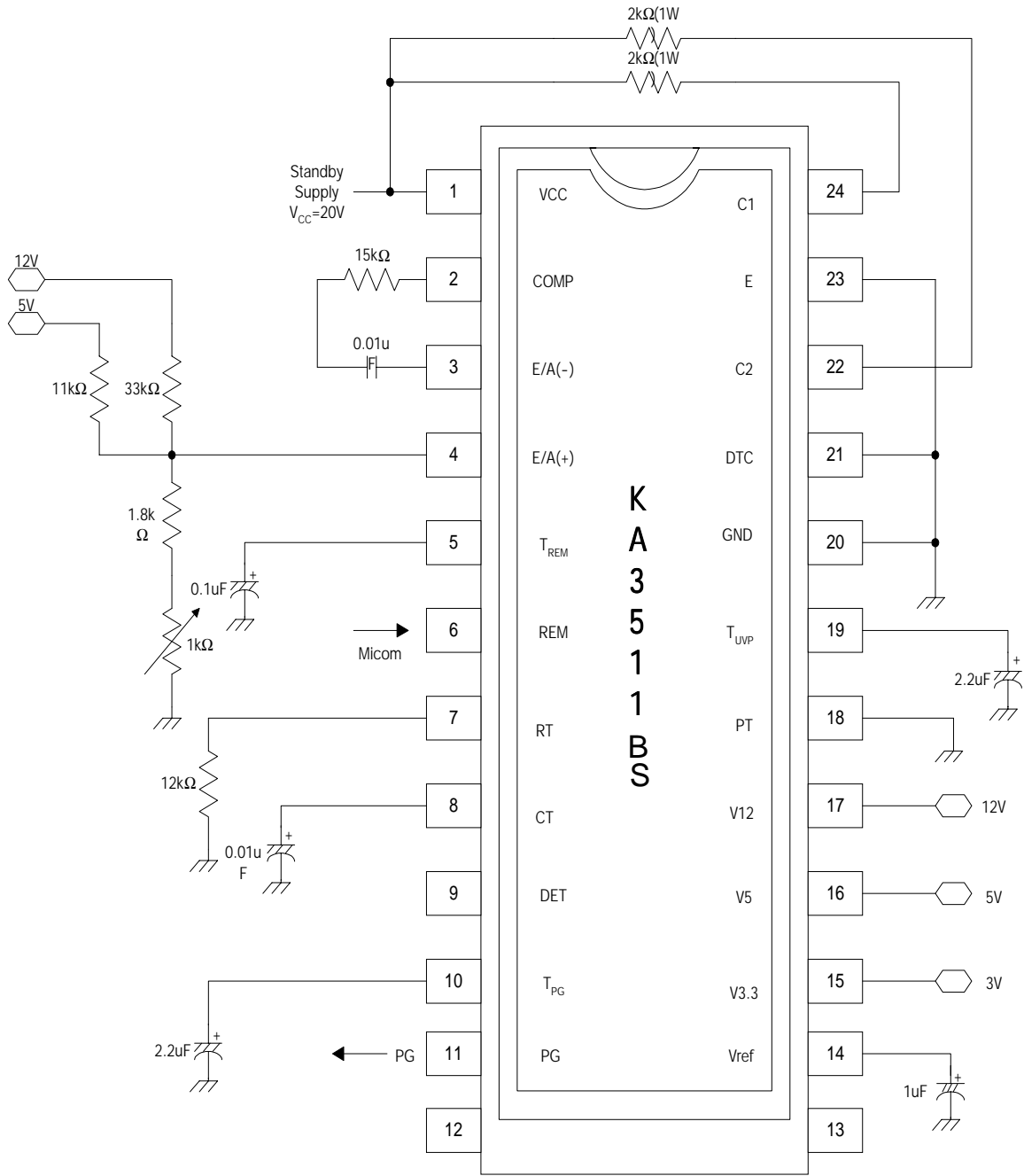

Figure 2. Operating Waveform

Housekeeping Circuit



Note :

The KA3511BS requires few external components to accomplish a complete housekeeping circuits for SMPS.

Typical Characteristics

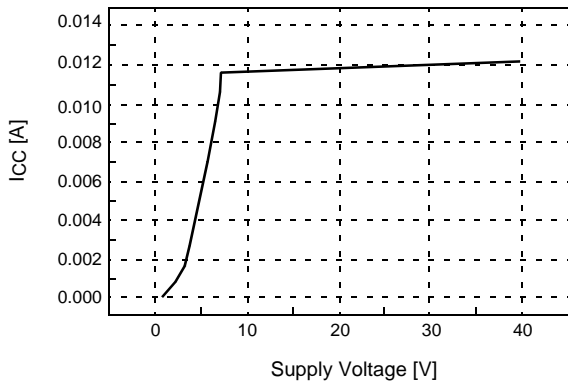

Figure 1. V_{CC}-I_{CC}

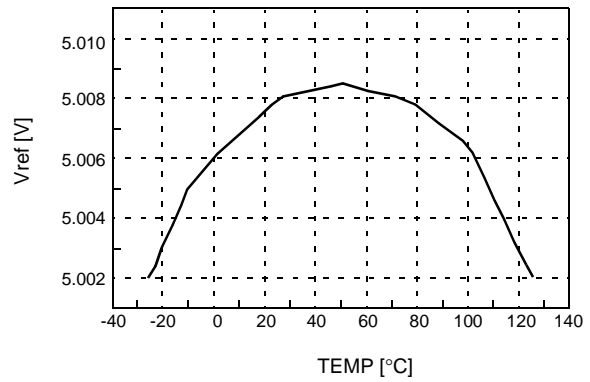

Figure 2. Bandgap Reference Voltage

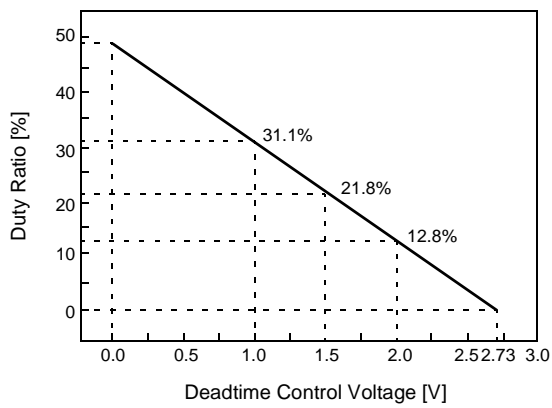

Figure 3. PIN19(Dead Time Control Voltage)-Duty Cycle

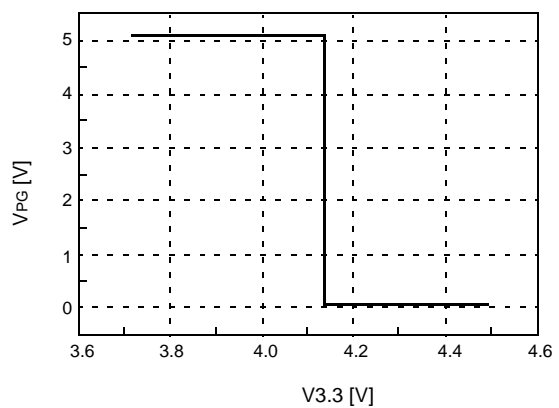

Figure 3. OVP for 3.3V

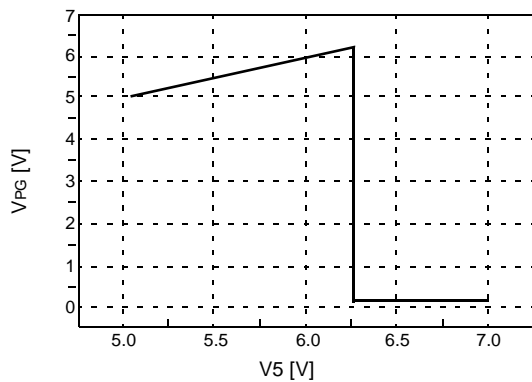

Figure 5. OVP for 5V

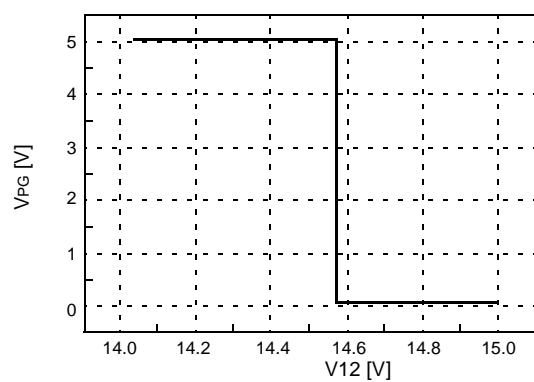

Figure 6. OVP for 12V

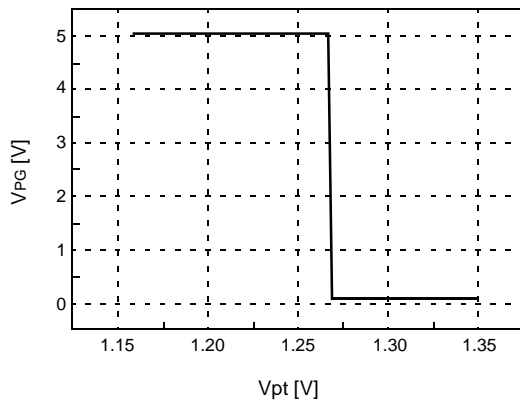

Figure 7. OVP for PT

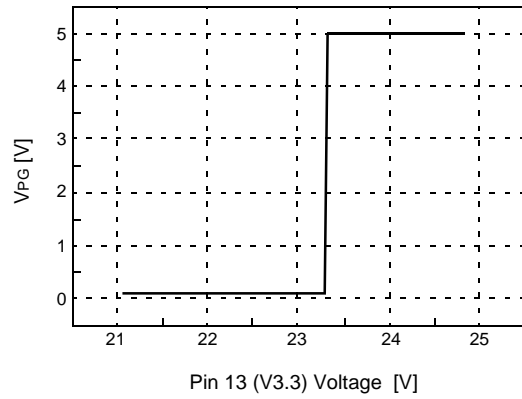

Figure 8. UVP for 3.3V

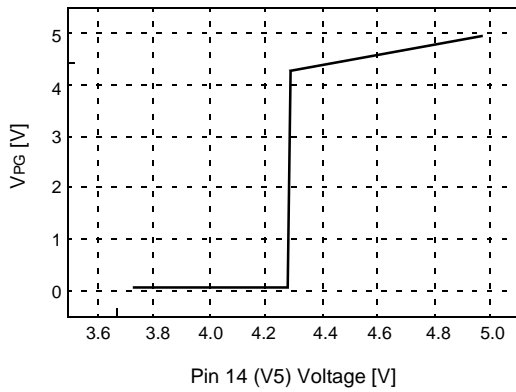

Figure 9 . UVP for 5V

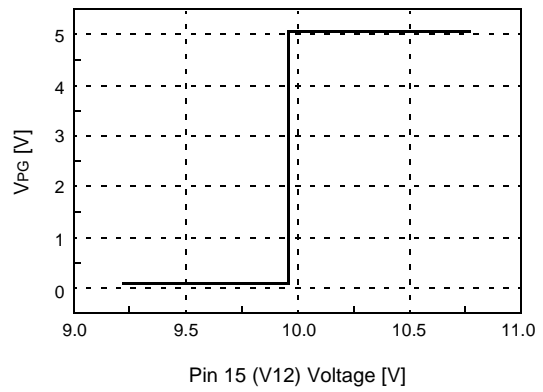

Figure 10 . UVP for 12V

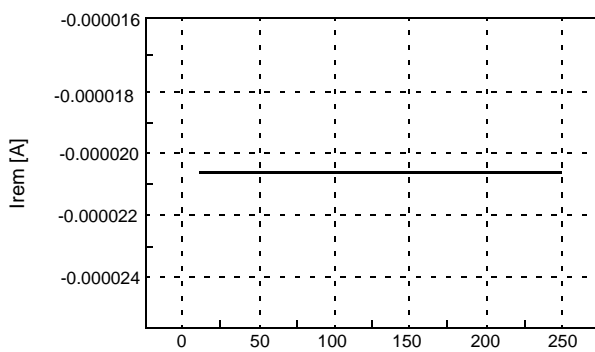

Figure 11 . Remote ON Charging Current

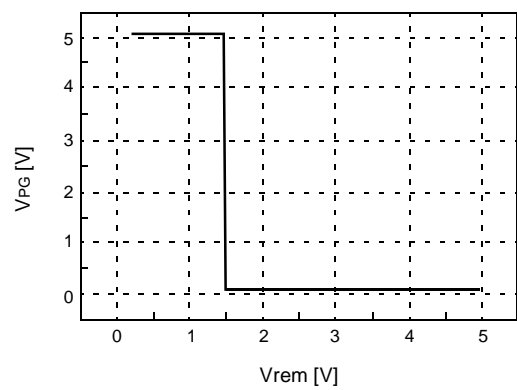

Figure 12 . REM ON/OFF V_{th}

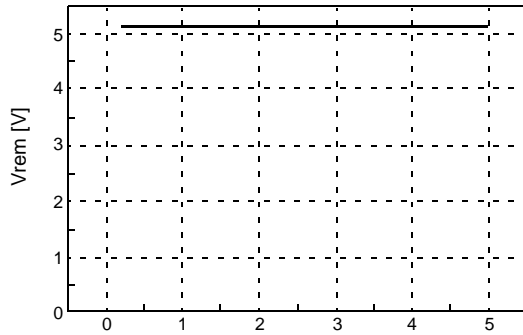

Figure 13. Remote ON Open Voltage

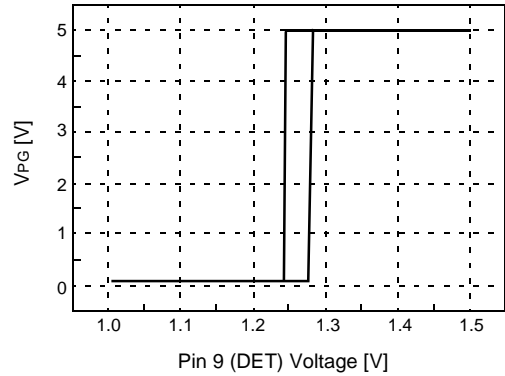

Figure 14. Detecting VCC Voltage (DET)

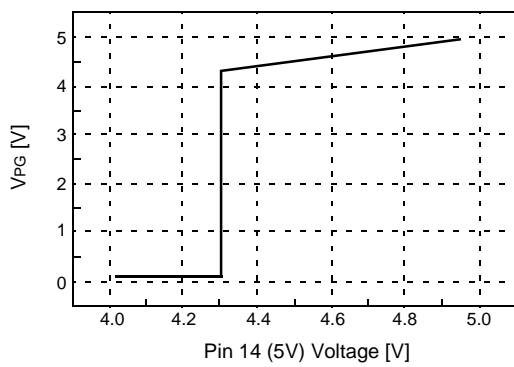

Figure 15. Detecting V5 Voltage

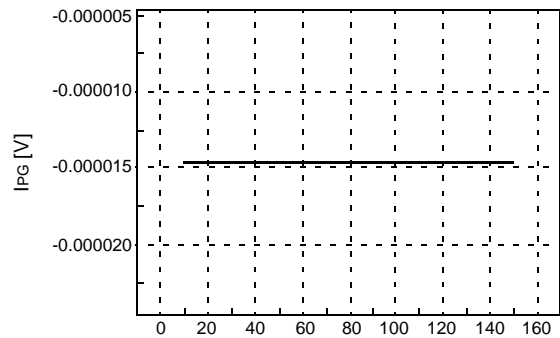

Figure 16. Charging Current for PG

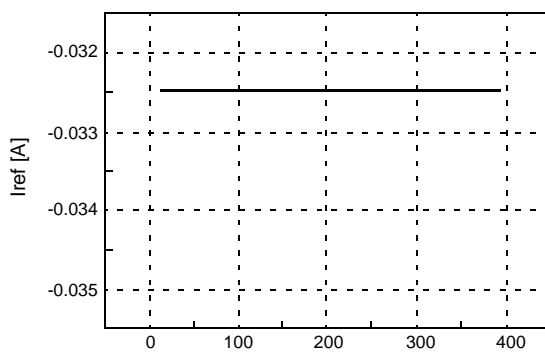

Figure 15. Short Circuit Current

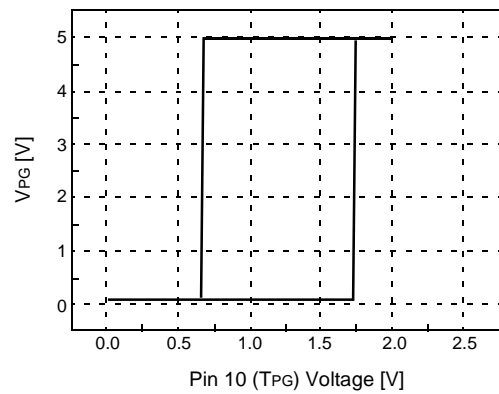

Figure 16. Hysteresis Voltage 2

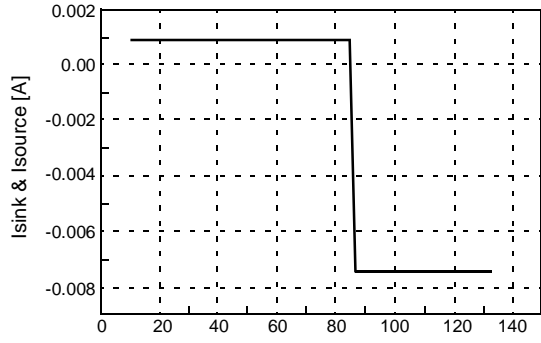

Figure 17. Error Amp Sink Current

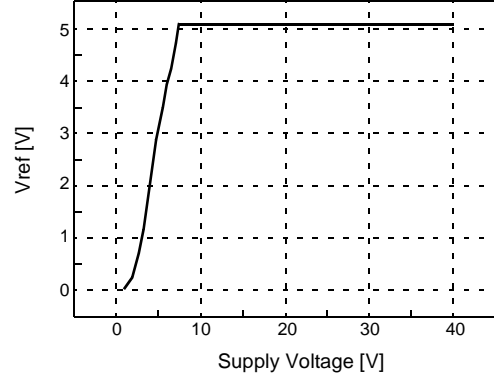

Figure 18. Reference Voltage

Experimental Result

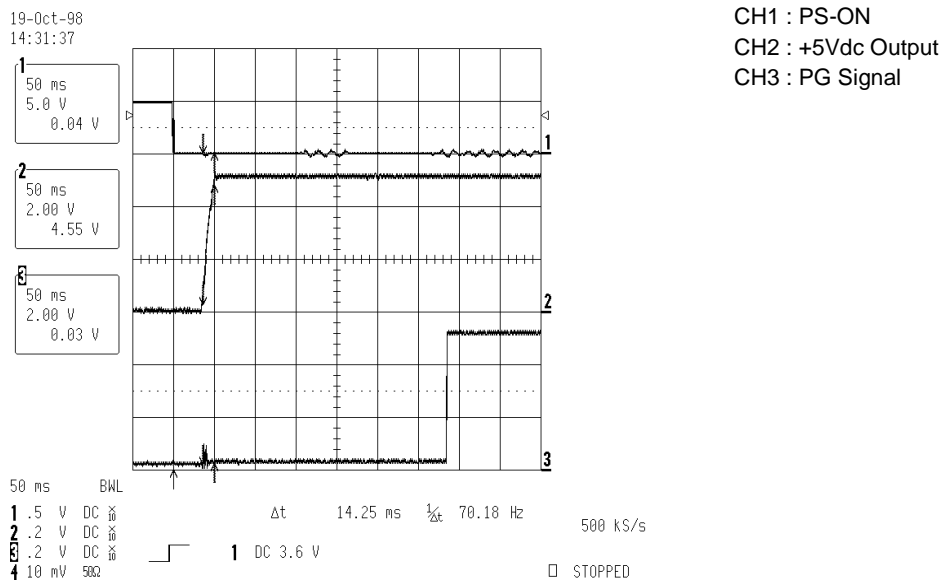

Figure 3. Rising Time of +5Vdc Output Voltage

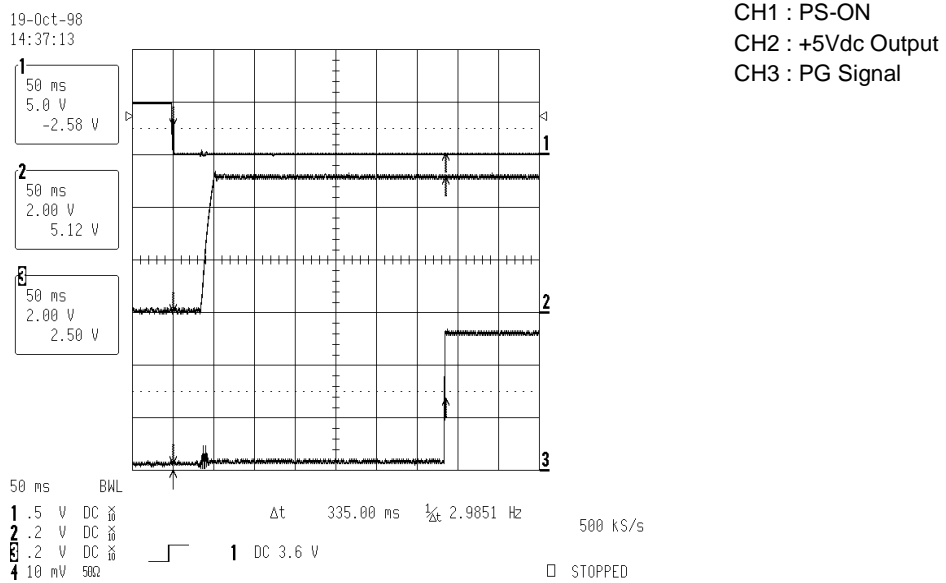

Figure 4. PG Signal Delay Time

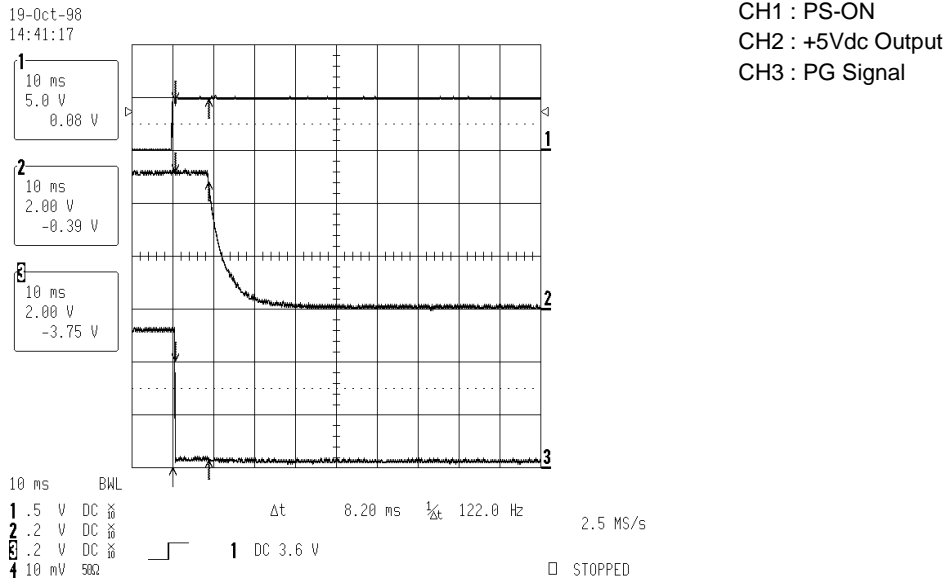

Figure 5. Power Down Warning

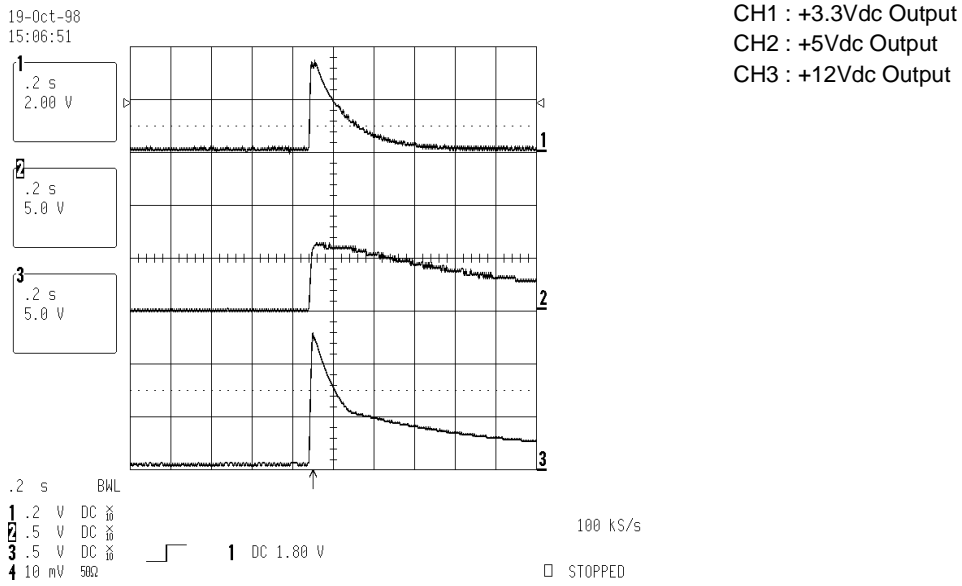

Figure 6. No Load Protection

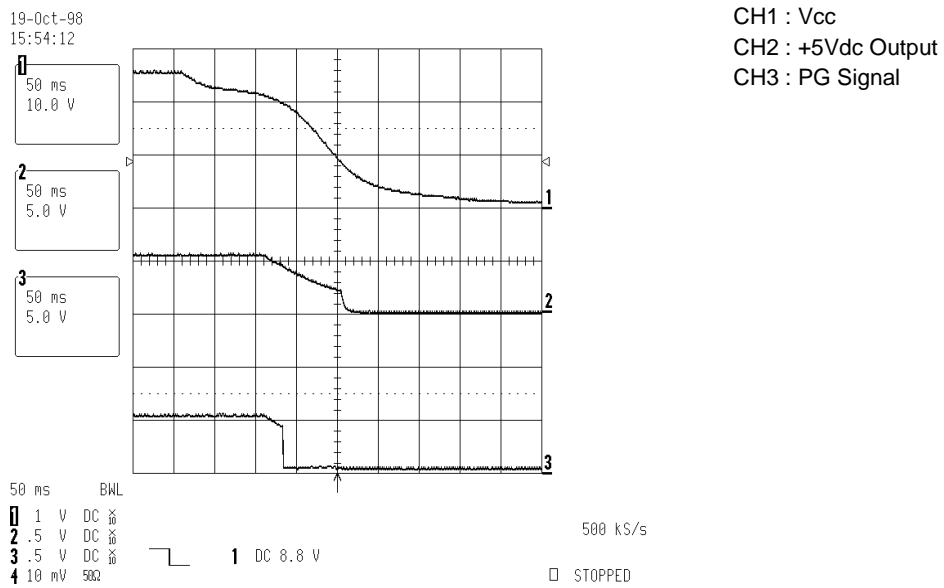

Figure 7. Vcc, +5Vdc Output vs. PG Signal (High)

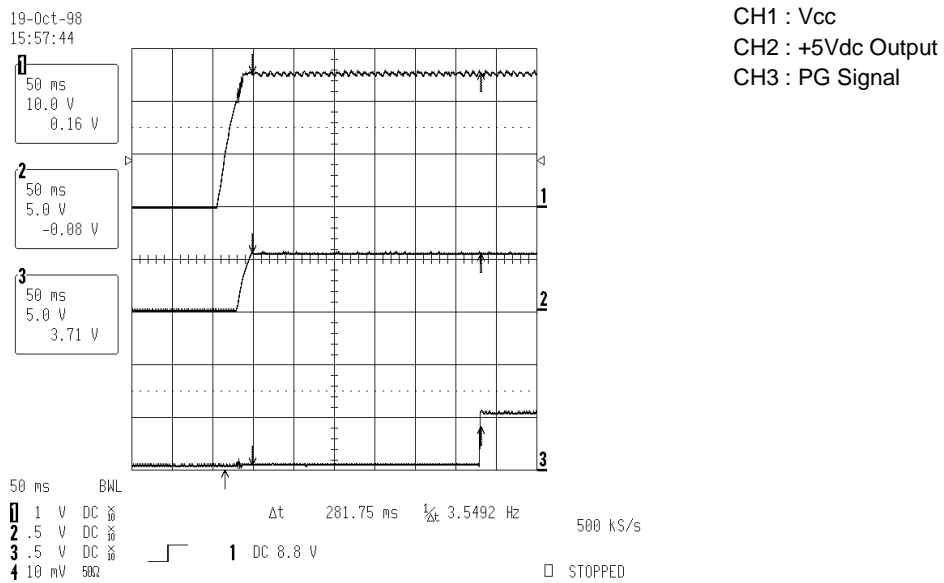
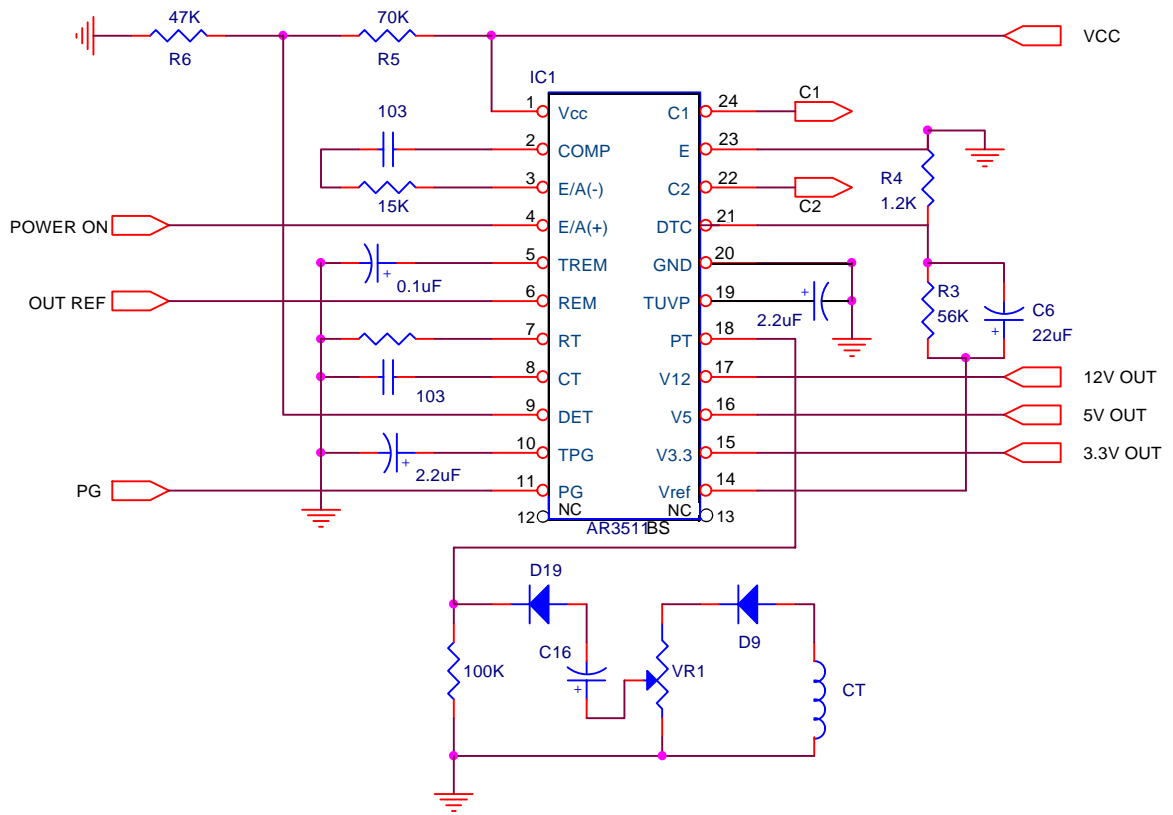

Figure 8. Vcc, +5Vdc Output vs. PG Signal (Low)

Application Circuit



Mechanical Dimensions

Package

Dimensions in millimeters

24-SDIP

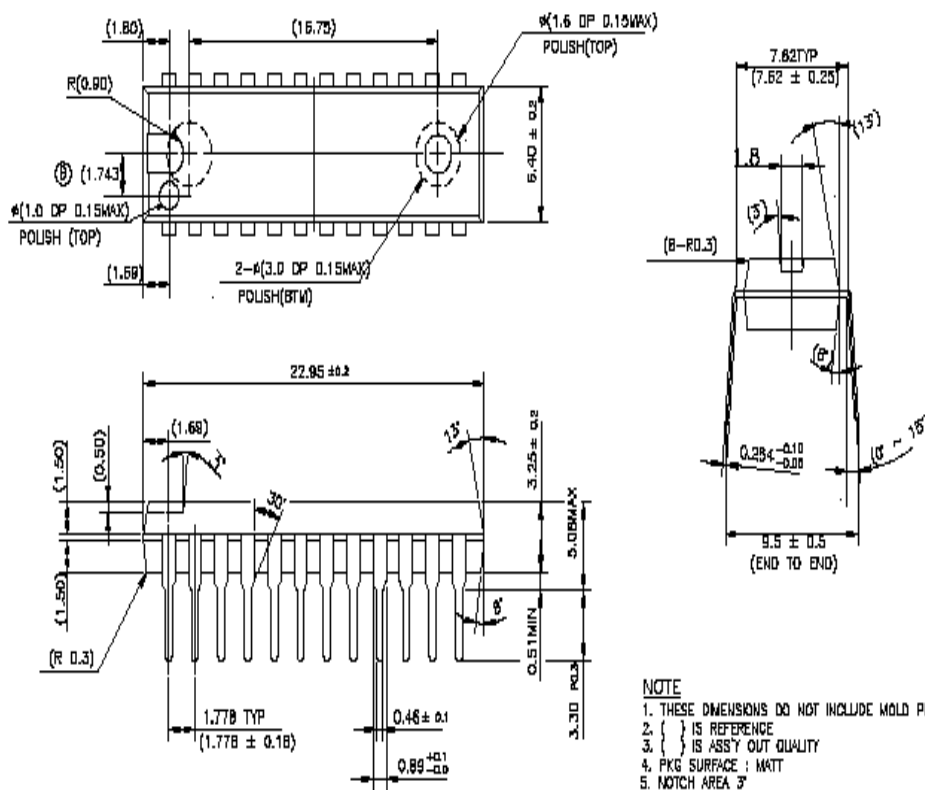

Ordering Information

Product Number	Package	Operating Temperature
KA3511BS	24-SDIP	0°C ~ 70°C

DISCLAIMER

FAIRCHILD SEMICONDUCTOR RESERVES THE RIGHT TO MAKE CHANGES WITHOUT FURTHER NOTICE TO ANY PRODUCTS HEREIN TO IMPROVE RELIABILITY, FUNCTION OR DESIGN. FAIRCHILD DOES NOT ASSUME ANY LIABILITY ARISING OUT OF THE APPLICATION OR USE OF ANY PRODUCT OR CIRCUIT DESCRIBED HEREIN; NEITHER DOES IT CONVEY ANY LICENSE UNDER ITS PATENT RIGHTS, NOR THE RIGHTS OF OTHERS.

LIFE SUPPORT POLICY

FAIRCHILD'S PRODUCTS ARE NOT AUTHORIZED FOR USE AS CRITICAL COMPONENTS IN LIFE SUPPORT DEVICES OR SYSTEMS WITHOUT THE EXPRESS WRITTEN APPROVAL OF THE PRESIDENT OF FAIRCHILD SEMICONDUCTOR INTERNATIONAL. As used herein:

1. Life support devices or systems are devices or systems which, (a) are intended for surgical implant into the body, or (b) support or sustain life, and (c) whose failure to perform when properly used in accordance with instructions for use provided in the labeling, can be reasonably expected to result in a significant injury of the user.
2. A critical component in any component of a life support device or system whose failure to perform can be reasonably expected to cause the failure of the life support device or system, or to affect its safety or effectiveness.